

ESP32-C6

Technical Reference Manual

PRELIMINARY



Pre-release v0.3
Espressif Systems
Copyright © 2023

About This Document

The **ESP32-C6** is targeted at developers working on low level software projects that use the ESP32-C6 SoC. It describes the hardware modules listed below for the ESP32-C6 SoC and other products in ESP32-C6 series. The modules detailed in this document provide an overview, list of features, hardware architecture details, any necessary programming procedures, as well as register descriptions.

Navigation in This Document

Here are some tips on navigation through this extensive document:

- [Release Status at a Glance](#) on the very next page is a minimal list of all chapters from where you can directly jump to a specific chapter.
- Use the **Bookmarks** on the side bar to jump to any specific chapters or sections from anywhere in the document. Note this PDF document is configured to automatically display **Bookmarks** when open, which is necessary for an extensive document like this one. However, some PDF viewers or browsers ignore this setting, so if you don't see the **Bookmarks** by default, try one or more of the following methods:
 - Install a PDF Reader Extension for your browser;
 - Download this document, and view it with your local PDF viewer;
 - Set your PDF viewer to always automatically display the **Bookmarks** on the left side bar when open.
- Use the native **Navigation** function of your PDF viewer to navigate through the documents. Most PDF viewers support to go **Up**, **Down**, **Previous**, **Next**, **Back**, **Forward** and **Page** with buttons, menu, or hot keys.
- You can also use the built-in **GoBack** button on the upper right corner on each and every page to go back to the previous place before you click a link within the document. Note this feature may only work with some Acrobat-specific PDF viewers (for example, Acrobat Reader and Adobe DC) and browsers with built-in Acrobat-specific PDF viewers or extensions (for example, Firefox).

Release Status at a Glance

Note that this manual is still work in progress. See our release progress below:

No.	ESP32-C6 Chapters	Progress
1	High-Performance CPU	Published
2	RISC-V Trace Encoder (TRACE)	Published
3	Low-Power CPU	Published
4	GDMA Controller (GDMA)	Published
5	System and Memory	Published
6	eFuse Controller	Published
7	IO MUX and GPIO Matrix (GPIO, IO MUX)	Published
8	Reset and Clock	Published
9	Chip Boot Control	Published
10	Interrupt Matrix (INTMTX)	Published
11	Event Task Matrix (SOC_ETM)	Published
12	Low-Power Management [to be added later]	21%
13	System Timer (SYSTIMER)	Published
14	Timer Group (TIMG)	Published
15	Watchdog Timers (WDT)	Published
16	Permission Control (PMS)	Published
17	System Registers (HP_SYSTEM)	Published
18	Debug Assistant (ASSIST_DEBUG)	Published
19	AES Accelerator (AES)	Published
20	ECC Accelerator (ECC)	Published
21	HMAC Accelerator (HMAC)	Published
22	RSA Accelerator (RSA)	Published
23	SHA Accelerator (SHA)	Published
24	Digital Signature (DS)	Published
25	External Memory Encryption and Decryption (XTS_AES)	Published
26	Random Number Generator (RNG)	Published
27	UART Controller (UART, LP_UART, UHCI)	Published
28	SPI Controller (SPI)	Published
29	I2C Controller (I2C)	Published
30	I2S Controller (I2S)	Published
31	Pulse Count Controller (PCNT)	Published
32	USB Serial/JTAG Controller (USB_SERIAL_JTAG)	Published
33	Two-wire Automotive Interface (TWAI)	Published
34	SDIO 2.0 Slave Controller (SDIO)	Published
35	LED PWM Controller (LEDC)	Published
36	Motor Control PWM (MCPWM)	Published
37	Remote Control Peripheral (RMT)	Published
38	Parallel IO Controller (PARL_IO)	Published
39	On-Chip Sensor and Analog Signal Processing	Published

Note:

Check the link or the QR code to make sure that you use the latest version of this document:
https://www.espressif.com/documentation/esp32-c6_technical_reference_manual_en.pdf



Contents

1	High-Performance CPU	35
1.1	Overview	35
1.2	Features	35
1.3	Terminology	36
1.4	Address Map	36
1.5	Configuration and Status Registers (CSRs)	36
1.5.1	Register Summary	36
1.5.2	Register Description	38
1.6	Interrupt Controller	51
1.6.1	Features	51
1.6.2	Functional Description	51
1.6.3	Suggested Operation	53
1.6.3.1	Latency Aspects	53
1.6.3.2	Configuration Procedure	54
1.6.4	Registers	55
1.7	Core Local Interrupts (CLINT)	56
1.7.1	Overview	56
1.7.2	Features	56
1.7.3	Software Interrupt	56
1.7.4	Timer Counter and Interrupt	56
1.7.5	Register Summary	57
1.7.6	Register Description	57
1.8	Physical Memory Protection	61
1.8.1	Overview	61
1.8.2	Features	61
1.8.3	Functional Description	61
1.8.4	Register Summary	62
1.8.5	Register Description	62
1.9	Physical Memory Attribute (PMA) Checker	63
1.9.1	Overview	63
1.9.2	Features	63
1.9.3	Functional Description	63
1.9.4	Register Summary	64
1.9.5	Register Description	65
1.10	Debug	66
1.10.1	Overview	66
1.10.2	Features	67
1.10.3	Functional Description	67
1.10.4	JTAG Control	67
1.10.5	Register Summary	68
1.10.6	Register Description	68
1.11	Hardware Trigger	71

1.11.1	Features	71
1.11.2	Functional Description	71
1.11.3	Trigger Execution Flow	72
1.11.4	Register Summary	72
1.11.5	Register Description	73
1.12	Trace	77
1.12.1	Overview	77
1.12.2	Features	77
1.12.3	Functional Description	77
1.13	Debug Cross-Triggering	78
1.13.1	Overview	78
1.13.2	Features	78
1.13.3	Functional Description	78
1.13.4	Register Summary	79
1.13.5	Register Description	79
1.14	Dedicated IO	80
1.14.1	Overview	80
1.14.2	Features	80
1.14.3	Functional Description	80
1.14.4	Register Summary	81
1.14.5	Register Description	81
1.15	Atomic (A) Extension	83
1.15.1	Overview	83
1.15.2	Functional Description	83
1.15.2.1	Load Reserve (LR.W) Instruction	83
1.15.2.2	Store Conditional (SC.W) Instruction	83
1.15.2.3	AMO Instructions	84
2	RISC-V Trace Encoder (TRACE)	85
2.1	Terminology	85
2.2	Introduction	85
2.3	Features	86
2.4	Architectural Overview	87
2.5	Functional Description	88
2.5.1	Synchronization	88
2.5.2	Anchor Tag	88
2.5.3	Memory Writing Mode	88
2.5.4	Automatic Restart	88
2.6	Encoder Output Packets	89
2.6.1	Header	89
2.6.2	Index	89
2.6.3	Payload	90
2.6.3.1	Format 3 Packets	90
2.6.3.2	Format 2 Packets	91
2.6.3.3	Format 1 Packets	92
2.7	Interrupt	93

2.8	Programming Procedures	93
2.8.1	Enable Encoder	93
2.8.2	Disable Encoder	94
2.8.3	Decode Data Packets	94
2.9	Register Summary	95
2.10	Registers	96
3	Low-Power CPU	101
3.1	Features	101
3.2	Configuration and Status Registers (CSRs)	102
3.2.1	Register Summary	102
3.2.2	Registers	103
3.3	Interrupts and Exceptions	109
3.3.1	Interrupts	110
3.3.2	Interrupt Handling	110
3.3.3	Exceptions	110
3.4	Debugging	110
3.4.1	Features	111
3.4.2	Functional Description	111
3.4.3	Register Summary	111
3.4.4	Registers	112
3.5	Hardware Trigger	113
3.5.1	Features	113
3.5.2	Functional Description	113
3.5.3	Trigger Execution Flow	114
3.5.4	Register Summary	114
3.5.5	Registers	114
3.6	Performance Counter	117
3.7	System Access	118
3.7.1	Memory Access	118
3.7.2	Peripheral Access	118
3.8	Event Task Matrix Feature	118
3.9	Sleep and Wake-Up Process	119
3.9.1	Features	119
3.9.2	Process	119
3.9.3	Wake-Up Sources	121
3.10	Register Summary	121
3.11	Registers	121
4	GDMA Controller (GDMA)	123
4.1	Overview	123
4.2	Features	123
4.3	Architecture	124
4.4	Functional Description	125
4.4.1	Linked List	125
4.4.2	Peripheral-to-Memory and Memory-to-Peripheral Data Transfer	126

4.4.3	Memory-to-Memory Data Transfer	126
4.4.4	Enabling GDMA	127
4.4.5	Linked List Reading Process	127
4.4.6	EOF	128
4.4.7	Accessing Internal RAM	128
4.4.8	Arbitration	129
4.4.9	Event Task Matrix Feature	129
4.5	GDMA Interrupts	130
4.6	Programming Procedures	131
4.6.1	Programming Procedures for GDMA's Transmit Channel	131
4.6.2	Programming Procedures for GDMA's Receive Channel	131
4.6.3	Programming Procedures for Memory-to-Memory Transfer	131
4.7	Register Summary	133
4.8	Registers	137
5	System and Memory	161
5.1	Overview	161
5.2	Features	161
5.3	Functional Description	162
5.3.1	Address Mapping	162
5.3.2	Internal Memory	163
5.3.3	External Memory	164
5.3.3.1	External Memory Address Mapping	164
5.3.3.2	Cache	164
5.3.3.3	Cache Operations	165
5.3.4	GDMA Address Space	166
5.3.5	Modules/Peripherals Address Mapping	166
6	eFuse Controller	169
6.1	Overview	169
6.2	Features	169
6.3	Functional Description	169
6.3.1	Structure	169
6.3.1.1	EFUSE_WR_DIS	176
6.3.1.2	EFUSE_RD_DIS	176
6.3.1.3	Data Storage	176
6.3.2	Programming of Parameters	178
6.3.3	Reading of Parameters by Users	180
6.3.4	eFuse VDDQ Timing	181
6.3.5	Parameters Used by Hardware Modules	181
6.3.6	Interrupts	182
6.4	Register Summary	183
6.5	Registers	187
7	IO MUX and GPIO Matrix (GPIO, IO MUX)	234
7.1	Overview	234

7.2	Features	234
7.3	Architectural Overview	235
7.4	Peripheral Input via GPIO Matrix	236
7.4.1	Overview	236
7.4.2	Signal Synchronization	237
7.4.3	Functional Description	237
7.4.4	Simple GPIO Input	239
7.5	Peripheral Output via GPIO Matrix	239
7.5.1	Overview	239
7.5.2	Functional Description	240
7.5.3	Simple GPIO Output	241
7.5.4	Sigma Delta Modulated Output (SDM)	241
7.5.4.1	Functional Description	241
7.5.4.2	SDM Configuration	242
7.6	Direct Input and Output via IO MUX	242
7.6.1	Overview	242
7.6.2	Functional Description	242
7.7	LP IO MUX for Low Power and Analog Input/Output	242
7.7.1	Overview	242
7.7.2	Low Power Capabilities	243
7.7.3	Analog Functions	243
7.8	Pin Functions in Light-sleep	243
7.9	Pin Hold Feature	244
7.10	Power Supplies and Management of GPIO Pins	244
7.10.1	Power Supplies of GPIO Pins	244
7.10.2	Power Supply Management	244
7.11	Peripheral Signal List	244
7.12	IO MUX Functions List	251
7.13	LP IO MUX Functions List	252
7.14	ETM Event and Task	253
7.14.1	ETM Event	253
7.14.2	ETM Task	253
7.15	Register Summary	254
7.15.1	GPIO Matrix Register Summary	254
7.15.2	IO MUX Register Summary	255
7.15.3	Sub Design Register Summary	256
7.15.4	LP IO MUX Register Summary	257
7.16	Registers	258
7.16.1	GPIO Matrix Registers	258
7.16.2	IO MUX Registers	270
7.16.3	Sub Design Registers	273
7.16.4	LP IO MUX Registers	282
8	Reset and Clock	292
8.1	Reset	292
8.1.1	Overview	292

8.1.2	Architectural Overview	292
8.1.3	Features	292
8.1.4	Functional Description	293
8.1.5	Peripheral Reset	294
8.2	Clock	294
8.2.1	Overview	294
8.2.2	Architectural Overview	294
8.2.3	Features	295
8.2.4	Functional Description	295
8.2.4.1	HP System Clock	295
8.2.4.2	LP System Clock	296
8.2.4.3	Peripheral Clocks	297
8.2.4.4	Wi-Fi and Bluetooth LE Clock	300
8.3	Programming Procedures	300
8.3.1	HP System Clock Configuration	300
8.3.2	LP System Clock Configuration	300
8.3.3	Peripheral Clock Reset and Configuration	300
8.4	Register Summary	301
8.4.1	PCR Registers	302
8.4.2	LP System Clock Registers	304
8.5	Registers	304
8.5.1	PCR Registers	304
8.5.2	LP Registers	351
9	Chip Boot Control	361
9.1	Overview	361
9.2	Functional Description	361
9.2.1	Default Configuration	361
9.2.2	Boot Mode Control	362
9.2.3	ROM Messages Printing Control	364
9.2.4	JTAG Signal Source Control	364
9.2.5	SDIO Sampling Input Edge and Output Driving Edge Control	365
10	Interrupt Matrix (INTMTX)	366
10.1	Overview	366
10.2	Features	366
10.3	Functional Description	367
10.3.1	Peripheral Interrupt Sources	367
10.3.2	CPU Interrupts	371
10.3.3	Assign Peripheral Interrupt Source to CPU Interrupt	371
10.3.3.1	Assign One Peripheral Interrupt Source (Source_X) to CPU	371
10.3.3.2	Assign Multiple Peripheral Interrupt Sources (Source_X) to CPU	371
10.3.3.3	Disable CPU Peripheral Interrupt Source (Source_X)	371
10.3.4	Query Current Interrupt Status of Peripheral Interrupt Source	372
10.4	Register Summary	373
10.4.1	Interrupt Matrix Register Summary	373

10.4.2	Interrupt Priority Register Summary	375
10.5	Registers	378
10.5.1	Interrupt Matrix Registers	378
10.5.2	Interrupt Priority Registers	382
11	Event Task Matrix (SOC_ETM)	386
11.1	Overview	386
11.2	Features	386
11.3	Functional Description	386
11.3.1	Architecture	386
11.3.2	Events	387
11.3.3	Tasks	390
11.3.4	Timing Considerations	394
11.3.5	Channel Control	395
11.4	Register Summary	396
11.5	Registers	399
12	System Timer (SYSTIMER)	403
12.1	Overview	403
12.2	Features	403
12.3	Clock Source Selection	404
12.4	Functional Description	404
12.4.1	Counter	404
12.4.2	Comparator and Alarm	405
12.4.3	Event Task Matrix	406
12.4.4	Synchronization Operation	406
12.4.5	Interrupt	407
12.5	Programming Procedure	407
12.5.1	Read Current Count Value	407
12.5.2	Configure One-Time Alarm in Target Mode	407
12.5.3	Configure Periodic Alarms in Period Mode	408
12.5.4	Update After Deep-sleep and Light-sleep	408
12.6	Register Summary	409
12.7	Registers	411
13	Timer Group (TIMG)	427
13.1	Overview	427
13.2	Features	427
13.3	Functional Description	428
13.3.1	16-bit Prescaler and Clock Selection	428
13.3.2	54-bit Time-base Counter	428
13.3.3	Alarm Generation	429
13.3.4	Timer Reload	430
13.3.5	Event Task Matrix Function	430
13.3.6	RTC_SLOW_CLK Frequency Calculation	431
13.3.7	Interrupts	431

13.4	Configuration and Usage	432
13.4.1	Timer as a Simple Clock	432
13.4.2	Timer as One-shot Alarm	433
13.4.3	Timer as Periodic Alarm by APB	433
13.4.4	Timer as Periodic Alarm by ETM	433
13.4.5	RTC_SLOW_CLK Frequency Calculation	434
13.5	Register Summary	436
13.6	Registers	437
14	Watchdog Timers (WDT)	451
14.1	Overview	451
14.2	Digital Watchdog Timers	452
14.2.1	Features	452
14.2.2	Functional Description	453
14.2.2.1	Clock Source and 32-Bit Counter	453
14.2.2.2	Stages and Timeout Actions	454
14.2.2.3	Write Protection	455
14.2.2.4	Flash Boot Protection	455
14.3	Super Watchdog	455
14.3.1	Features	455
14.3.2	Super Watchdog Controller	456
14.3.2.1	Structure	456
14.3.2.2	Workflow	456
14.4	Interrupts	456
14.5	Register Summary	457
14.6	Registers	457
15	Permission Control (PMS)	466
15.1	Overview	466
15.2	Features	467
15.3	Functional Description	467
15.3.1	TEE Controller Functional Description	467
15.3.2	APM Controller Functional Description	468
15.3.2.1	Architecture	468
15.3.2.2	Address Ranges	469
15.3.2.3	Access Permissions of Address Ranges	469
15.4	Programming Procedure	470
15.5	Illegal access and interrupts	471
15.6	Register Summary	472
15.6.1	High Performance APM Registers (HP_APM_REG)	472
15.6.2	Low Power APM Registers (LP_APM_REG)	474
15.6.3	Low Power APM0 Registers (LP_APM0_REG)	474
15.6.4	High Performance TEE Registers	475
15.6.5	Low Power TEE Registers	476
15.7	Registers	477
15.7.1	High Performance APM Registers (HP_APM_REG)	477

15.7.2	Low Power APM Registers (LP_APM_REG)	485
15.7.3	Low Power APM0 Registers (LP_APM0_REG)	492
15.7.4	High Performance TEE Registers	496
15.7.5	Low Power TEE Registers	497
16	System Registers (HP_SYSTEM)	499
16.1	Overview	499
16.2	Features	499
16.3	Function Description	499
16.3.1	External Memory Encryption/Decryption Configuration	499
16.3.2	Anti-DPA Attack Security Control	499
16.3.3	Software ROM Table Register	500
16.3.4	HP Core/LP Core Debug Control	500
16.3.5	Bus Timeout Protection	500
16.3.5.1	CPU Peripheral Timeout Protection Register	500
16.3.5.2	HP Peripheral Timeout Protection Register	501
16.3.5.3	LP Peripheral Timeout Protection Register	501
16.4	Register Summary	502
16.5	Registers	503
17	Debug Assistant (ASSIST_DEBUG)	511
17.1	Overview	511
17.2	Features	511
17.3	Functional Description	511
17.3.1	Region Read/Write Monitoring	511
17.3.2	SP Monitoring	511
17.3.3	PC Logging	511
17.3.4	CPU/DMA Bus Access Logging	511
17.4	Recommended Operation	512
17.4.1	Region Monitoring and SP Monitoring Configuration	512
17.4.2	PC Logging Configuration	513
17.4.3	CPU/DMA Bus Access Logging Configuration	513
17.5	Register Summary	518
17.5.1	Summary of Bus Logging Configuration Registers	518
17.5.2	Summary of Other Registers	518
17.6	Registers	521
17.6.1	Bus Logging Configuration Registers	522
17.6.2	Other Registers	528
18	AES Accelerator (AES)	543
18.1	Introduction	543
18.2	Features	543
18.3	AES Working Modes	543
18.4	Typical AES Working Mode	545
18.4.1	Key, Plaintext, and Ciphertext	545
18.4.2	Endianness	545

18.4.3	Operation Process	547
18.5	DMA-AES Working Mode	547
18.5.1	Key, Plaintext, and Ciphertext	548
18.5.2	Endianness	548
18.5.3	Standard Incrementing Function	549
18.5.4	Block Number	549
18.5.5	Initialization Vector	549
18.5.6	Block Operation Process	550
18.6	Memory Summary	550
18.7	Register Summary	551
18.8	Registers	552
19	ECC Accelerator (ECC)	557
19.1	Introduction	557
19.2	Features	557
19.3	Terminology	557
19.3.1	ECC Basics	557
19.3.1.1	Elliptic Curve and Points on the Curves	557
19.3.1.2	Affine Coordinates and Jacobian Coordinates	557
19.3.2	Definitions of ESP32-C6's ECC	558
19.3.2.1	Memory Blocks	558
19.3.2.2	Data and Data Block	558
19.3.2.3	Write Data	558
19.3.2.4	Read Data	559
19.3.2.5	Standard Calculation and Jacobian Calculation	559
19.4	Function Description	559
19.4.1	Key Size	559
19.4.2	Working Modes	559
19.4.2.1	Base Point Multiplication (Point Multi Mode)	560
19.4.2.2	Base Point Verification (Point Verif Mode)	560
19.4.2.3	Base Point Verification + Base Point Multiplication (Point Verif + Multi Mode)	560
19.4.2.4	Jacobian Point Multiplication (Jacobian Point Multi Mode)	560
19.4.2.5	Jacobian Point Verification (Jacobian Point Verif Mode)	561
19.4.2.6	Base Point Verification + Jacobian Point Multiplication (Point Verif + Jacobian Point Multi Mode)	561
19.5	Clocks and Resets	561
19.6	Interrupts	561
19.7	Programming Procedures	562
19.8	Register Summary	563
19.9	Registers	564
20	HMAC Accelerator (HMAC)	568
20.1	Main Features	568
20.2	Functional Description	568
20.2.1	Upstream Mode	568
20.2.2	Downstream JTAG Enable Mode	569

20.2.3	Downstream Digital Signature Mode	569
20.2.4	HMAC eFuse Configuration	569
20.2.5	HMAC Process (Detailed)	570
20.3	HMAC Algorithm Details	572
20.3.1	Padding Bits	572
20.3.2	HMAC Algorithm Structure	573
20.4	Register Summary	575
20.5	Registers	577
21	RSA Accelerator (RSA)	584
21.1	Introduction	584
21.2	Features	584
21.3	Functional Description	584
21.3.1	Large-number Modular Exponentiation	584
21.3.2	Large-number Modular Multiplication	586
21.3.3	Large-number Multiplication	586
21.3.4	Options for Additional Acceleration	587
21.4	Memory Summary	589
21.5	Register Summary	589
21.6	Registers	590
22	SHA Accelerator (SHA)	594
22.1	Introduction	594
22.2	Features	594
22.3	Working Modes	594
22.4	Function Description	595
22.4.1	Preprocessing	595
22.4.1.1	Padding the Message	595
22.4.1.2	Parsing the Message	595
22.4.1.3	Setting the Initial Hash Value	596
22.4.2	Hash Operation	596
22.4.2.1	Typical SHA Mode Process	596
22.4.2.2	DMA-SHA Mode Process	597
22.4.3	Message Digest	598
22.4.4	Interrupt	599
22.5	Register Summary	600
22.6	Registers	601
23	Digital Signature (DS)	605
23.1	Overview	605
23.2	Features	605
23.3	Functional Description	605
23.3.1	Overview	605
23.3.2	Private Key Operands	606
23.3.3	Software Prerequisites	606
23.3.4	DS Operation at the Hardware Level	607

23.3.5	DS Operation at the Software Level	608
23.4	Memory Summary	610
23.5	Register Summary	611
23.6	Registers	612
24	External Memory Encryption and Decryption (XTS_AES)	615
24.1	Overview	615
24.2	Features	615
24.3	Module Structure	615
24.4	Functional Description	616
24.4.1	XTS Algorithm	616
24.4.2	Key	616
24.4.3	Target Memory Space	617
24.4.4	Data Writing	617
24.4.5	Manual Encryption Block	618
24.4.6	Auto Decryption Block	618
24.5	Software Process	619
24.6	Anti-DPA	619
24.7	Register Summary	621
24.8	Registers	622
25	Random Number Generator (RNG)	626
25.1	Introduction	626
25.2	Features	626
25.3	Functional Description	626
25.4	Programming Procedure	627
25.5	Register Summary	627
25.6	Register	627
26	UART Controller (UART, LP_UART, UHCI)	628
26.1	Overview	628
26.2	Features	628
26.3	UART Structure	629
26.4	Functional Description	630
26.4.1	Clock and Reset	630
26.4.2	UART FIFO	630
26.4.3	Baud Rate Generation and Detection	632
26.4.3.1	Baud Rate Generation	632
26.4.3.2	Baud Rate Detection	633
26.4.4	UART Data Frame	634
26.4.5	AT_CMD Character Structure	634
26.4.6	RS485	635
26.4.6.1	Driver Control	635
26.4.6.2	Turnaround Delay	635
26.4.6.3	Bus Snooping	636
26.4.7	IrDA	636

26.4.8	Wake-up	637
26.4.9	Flow Control	637
26.4.9.1	Hardware Flow Control	638
26.4.9.2	Software Flow Control	639
26.4.10	GDMA Mode	640
26.4.11	UART Interrupts	640
26.4.12	UHCI Interrupts	641
26.5	Programming Procedures	642
26.5.1	Register Type	642
26.5.2	Detailed Steps	642
26.5.2.1	Initializing UART n	643
26.5.2.2	Configuring UART n Communication	643
26.5.2.3	Enabling UART n	644
26.6	Register Summary	645
26.6.1	UART Register Summary	645
26.6.2	LP UART Register Summary	646
26.6.3	UHCI Register Summary	647
26.7	Registers	649
26.7.1	UART Registers	649
26.7.2	LP UART Registers	671
26.7.3	UHCI Registers	691
27	SPI Controller (SPI)	714
27.1	Overview	714
27.2	Glossary	714
27.3	Features	715
27.4	Architectural Overview	716
27.5	Functional Description	716
27.5.1	Data Modes	716
27.5.2	Introduction to FSPI Bus Signals	717
27.5.3	Bit Read/Write Order Control	719
27.5.4	Transfer Types	721
27.5.5	CPU-Controlled Data Transfer	721
27.5.5.1	CPU-Controlled Master Transfer	721
27.5.5.2	CPU-Controlled Slave Transfer	723
27.5.6	DMA-Controlled Data Transfer	724
27.5.6.1	GDMA Configuration	724
27.5.6.2	GDMA TX/RX Buffer Length Control	725
27.5.7	Data Flow Control	726
27.5.7.1	GP-SPI2 Functional Blocks	726
27.5.7.2	Data Flow Control as Master	727
27.5.7.3	Data Flow Control as Slave	727
27.5.8	GP-SPI2 as a Master	728
27.5.8.1	State Machine	729
27.5.8.2	Register Configuration for State and Bit Mode Control	731
27.5.8.3	Full-Duplex Communication (1-bit Mode Only)	734

27.5.8.4	Half-Duplex Communication (1/2/4-bit Mode)	735
27.5.8.5	DMA-Controlled Configurable Segmented Transfer	737
27.5.9	GP-SPI2 Works as a Slave	740
27.5.9.1	Communication Formats	741
27.5.9.2	Supported CMD Values in Half-Duplex Communication	742
27.5.9.3	Slave Single Transfer and Slave Segmented Transfer	744
27.5.9.4	Configuration of Slave Single Transfer	745
27.5.9.5	Configuration of Slave Segmented Transfer in Half-Duplex	745
27.5.9.6	Configuration of Slave Segmented Transfer in Full-Duplex	746
27.6	CS Setup Time and Hold Time Control	746
27.7	GP-SPI2 Clock Control	747
27.7.1	Clock Phase and Polarity	748
27.7.2	Clock Control as Master	750
27.7.3	Clock Control as Slave	750
27.8	GP-SPI2 Timing Compensation	750
27.9	Interrupts	752
27.10	Register Summary	755
27.11	Registers	756
28	I2C Controller (I2C)	786
28.1	Overview	786
28.2	Features	786
28.3	I2C Architecture	787
28.4	Functional Description	789
28.4.1	Clock Configuration	789
28.4.2	SCL and SDA Noise Filtering	790
28.4.3	SCL Clock Stretching	790
28.4.4	Generating SCL Pulses in Idle State	790
28.4.5	Synchronization	790
28.4.6	Open-Drain Output	791
28.4.7	Timing Parameter Configuration	792
28.4.8	Timeout Control	794
28.4.9	Command Configuration	794
28.4.10	TX/RX RAM Data Storage	795
28.4.11	Data Conversion	796
28.4.12	Addressing Mode	796
28.4.13	R/\overline{W} Bit Check in 10-bit Addressing Mode	797
28.4.14	To Start the I2C Controller	797
28.5	Functional differences between LP_I2C and I2C	797
28.6	Programming Example	798
28.6.1	I2C _{master} Writes to I2C _{slave} with a 7-bit Address in One Command Sequence	798
28.6.1.1	Introduction	798
28.6.1.2	Configuration Example	798
28.6.2	I2C _{master} Writes to I2C _{slave} with a 10-bit Address in One Command Sequence	799
28.6.2.1	Introduction	800
28.6.2.2	Configuration Example	800

28.6.3	I2C _{master} Writes to I2C _{slave} with Two 7-bit Addresses in One Command Sequence	801
28.6.3.1	Introduction	801
28.6.3.2	Configuration Example	802
28.6.4	I2C _{master} Writes to I2C _{slave} with a 7-bit Address in Multiple Command Sequences	803
28.6.4.1	Introduction	803
28.6.4.2	Configuration Example	804
28.6.5	I2C _{master} Reads I2C _{slave} with a 7-bit Address in One Command Sequence	805
28.6.5.1	Introduction	805
28.6.5.2	Configuration Example	806
28.6.6	I2C _{master} Reads I2C _{slave} with a 10-bit Address in One Command Sequence	807
28.6.6.1	Introduction	807
28.6.6.2	Configuration Example	808
28.6.7	I2C _{master} Reads I2C _{slave} with Two 7-bit Addresses in One Command Sequence	809
28.6.7.1	Introduction	809
28.6.7.2	Configuration Example	810
28.6.8	I2C _{master} Reads I2C _{slave} with a 7-bit Address in Multiple Command Sequences	811
28.6.8.1	Introduction	812
28.6.8.2	Configuration Example	813
28.7	Interrupts	814
28.8	Register Summary	816
28.9	I2C Register Summary	816
28.10	LP_I2C Register Summary	817
28.11	I2C Registers	819
28.11.1	LP_I2C	842
29	I2S Controller (I2S)	865
29.1	Overview	865
29.2	Terminology	865
29.3	Features	866
29.4	System Architecture	867
29.5	Supported Audio Standards	868
29.5.1	TDM Philips Standard	869
29.5.2	TDM MSB Alignment Standard	869
29.5.3	TDM PCM Standard	870
29.5.4	PDM Standard	870
29.6	I2S TX/RX Clock	871
29.7	I2S Reset	873
29.8	I2S Master/Slave Mode	873
29.8.1	Master/Slave TX Mode	873
29.8.2	Master/Slave RX Mode	874
29.9	Transmitting Data	874
29.9.1	Data Format Control	874
29.9.1.1	Bit Width Control of Channel Valid Data	874
29.9.1.2	Endian Control of Channel Valid Data	875
29.9.1.3	A-law/ μ -law Compression and Decompression	875
29.9.1.4	Bit Width Control of Channel TX Data	876

29.9.1.5	Bit Order Control of Channel Data	876
29.9.2	Channel Mode Control	877
29.9.2.1	I2S Channel Control in TDM TX Mode	877
29.9.2.2	I2S Channel Control in PDM TX Mode	878
29.10	Receiving Data	881
29.10.1	Channel Mode Control	881
29.10.1.1	I2S Channel Control in TDM RX Mode	881
29.10.1.2	I2S Channel Control in PDM RX Mode	882
29.10.2	Data Format Control	882
29.10.2.1	Bit Order Control of Channel Data	882
29.10.2.2	Bit Width Control of Channel Storage (Valid) Data	882
29.10.2.3	Bit Width Control of Channel RX Data	883
29.10.2.4	Endian Control of Channel Storage Data	883
29.10.2.5	A-law/ μ -law Compression and Decompression	883
29.11	Software Configuration Process	884
29.11.1	Configure I2S as TX Mode	884
29.11.2	Configure I2S as RX Mode	884
29.12	I2S Interrupts	885
29.12.1	Event Task Matrix Feature	885
29.13	Register Summary	887
29.14	Registers	888
30	Pulse Count Controller (PCNT)	905
30.1	Features	905
30.2	Functional Description	906
30.3	Applications	908
30.3.1	Channel 0 Incrementing Independently	908
30.3.2	Channel 0 Decrementing Independently	909
30.3.3	Channel 0 and Channel 1 Incrementing Together	909
30.4	Register Summary	911
30.5	Registers	912
31	USB Serial/JTAG Controller (USB_SERIAL_JTAG)	920
31.1	Overview	920
31.2	Features	920
31.3	Functional Description	922
31.3.1	CDC-ACM USB Interface Functional Description	922
31.3.2	CDC-ACM Firmware Interface Functional Description	923
31.3.3	USB-to-JTAG Interface: JTAG Command Processor	924
31.3.4	USB-to-JTAG Interface: CMD_REP Usage Example	925
31.3.5	USB-to-JTAG Interface: Response Capture Unit	926
31.3.6	USB-to-JTAG Interface: Control Transfer Requests	926
31.4	Recommended Operation	927
31.5	Interrupts	928
31.6	Register Summary	930
31.7	Registers	932

32 Two-wire Automotive Interface (TWAI)	956
32.1 Features	956
32.2 Protocol Overview	956
32.2.1 TWAI Properties	956
32.2.2 TWAI Messages	957
32.2.2.1 Data Frames and Remote Frames	958
32.2.2.2 Error and Overload Frames	960
32.2.2.3 Interframe Space	962
32.2.3 TWAI Errors	962
32.2.3.1 Error Types	962
32.2.3.2 Error States	963
32.2.3.3 Error Counters	963
32.2.4 TWAI Bit Timing	964
32.2.4.1 Nominal Bit	964
32.2.4.2 Hard Synchronization and Resynchronization	965
32.3 Architectural Overview	966
32.3.1 Registers Block	966
32.3.2 Bit Stream Processor	967
32.3.3 Error Management Logic	967
32.3.4 Bit Timing Logic	967
32.3.5 Acceptance Filter	967
32.3.6 Receive FIFO	968
32.4 Functional Description	968
32.4.1 Modes	968
32.4.1.1 Reset Mode	968
32.4.1.2 Operation Mode	968
32.4.2 Bit Timing	969
32.4.3 Interrupt Management	969
32.4.3.1 Receive Interrupt (RXI)	970
32.4.3.2 Transmit Interrupt (TXI)	970
32.4.3.3 Error Warning Interrupt (EWI)	970
32.4.3.4 Data Overrun Interrupt (DOI)	971
32.4.3.5 Error Passive Interrupt (TXI)	971
32.4.3.6 Arbitration Lost Interrupt (ALI)	971
32.4.3.7 Bus Error Interrupt (BEI)	971
32.4.3.8 Bus Idle Status Interrupt (BISI)	971
32.4.4 Transmit and Receive Buffers	971
32.4.4.1 Overview of Buffers	971
32.4.4.2 Frame Information	972
32.4.4.3 Frame Identifier	973
32.4.4.4 Frame Data	974
32.4.5 Receive FIFO and Data Overruns	974
32.4.6 Acceptance Filter	975
32.4.6.1 Single Filter Mode	975
32.4.6.2 Dual Filter Mode	976
32.4.7 Error Management	976

32.4.7.1	Error Warning Limit	977
32.4.7.2	Error Passive	978
32.4.7.3	Bus-Off and Bus-Off Recovery	978
32.4.8	Error Code Capture	979
32.4.9	Arbitration Lost Capture	980
32.4.10	Transceiver Auto-Standby	980
32.5	Register Summary	982
32.6	Registers	983
33	SDIO 2.0 Slave Controller (SDIO)	998
33.1	Overview	998
33.2	Features	998
33.3	Architecture Overview	998
33.4	Standards Compliance	999
33.5	Functional Description	999
33.5.1	Physical Bus	999
33.5.2	Supported Commands	999
33.5.3	I/O Function 0 Address Space	1000
33.5.4	I/O Function 1/2 Address Space Map	1002
33.5.4.1	Accessing SLC HOST Register Space	1002
33.5.4.2	Transferring Incremental-Address Packets	1003
33.5.4.3	Transferring Fixed-Address Packets	1003
33.5.5	DMA	1003
33.5.5.1	Linked List	1004
33.5.5.2	Write-Back of Linked List	1006
33.5.5.3	Data Padding and Discarding	1006
33.5.6	SDIO Bus Timing	1007
33.6	Interrupt	1008
33.6.1	Host Interrupt	1008
33.6.2	Slave Interrupt	1009
33.7	Packet Sending and Receiving Procedure	1009
33.7.1	Sending Packets to SDIO Host	1009
33.7.2	Receiving Packets from SDIO Host	1011
33.8	Register Summary	1014
33.8.1	HINF Register Summary	1014
33.8.2	SLC Register Summary	1014
33.8.3	SLC Host Register Summary	1015
33.9	Registers	1016
33.9.1	HINF Registers	1016
33.9.2	SLC Registers	1021
33.9.3	SLC Host Registers	1043
34	LED PWM Controller (LEDC)	1055
34.1	Overview	1055
34.2	Features	1055
34.3	Functional Description	1056

34.3.1	Architecture	1056
34.3.2	Timers	1056
34.3.2.1	Clock Source	1056
34.3.2.2	Clock Divider Configuration	1057
34.3.2.3	20-Bit Counter	1058
34.3.3	PWM Generators	1059
34.3.4	Duty Cycle Fading	1060
34.3.4.1	Linear Duty Cycle Fading	1060
34.3.4.2	Gamma Curve Fading	1061
34.3.4.3	Suspend and Resume Duty Cycle Fading	1063
34.3.5	Event Task Matrix Feature	1063
34.3.6	Interrupts	1065
34.4	Register Summary	1066
34.5	Registers	1069
35	Motor Control PWM (MCPWM)	1082
35.1	Overview	1082
35.2	Features	1082
35.3	Modules	1085
35.3.1	Overview	1085
35.3.1.1	Prescaler Module	1085
35.3.1.2	Timer Module	1085
35.3.1.3	Operator Module	1086
35.3.1.4	Fault Detection Module	1087
35.3.1.5	Capture Module	1088
35.3.1.6	ETM Module	1088
35.3.2	PWM Timer Module	1088
35.3.2.1	Configurations of the PWM Timer Module	1088
35.3.2.2	PWM Timer's Working Modes and Timing Event Generation	1089
35.3.2.3	Shadow Register of PWM Timer	1094
35.3.2.4	PWM Timer Synchronization and Phase Locking	1094
35.3.3	PWM Operator Module	1094
35.3.3.1	PWM Generator Module	1096
35.3.3.2	Dead Time Generator Module	1107
35.3.3.3	PWM Carrier Module	1110
35.3.3.4	Fault Detection Module	1113
35.3.4	Capture Module	1114
35.3.4.1	Introduction	1114
35.3.4.2	Capture Timer	1115
35.3.4.3	Capture Channel	1115
35.3.5	ETM Module	1115
35.3.5.1	Overview	1115
35.3.5.2	MCPWM-Related ETM Events	1115
35.3.5.3	MCPWM-Related ETM Tasks	1116
35.4	Register Summary	1117
35.5	Registers	1120

36 Remote Control Peripheral (RMT)	1193
36.1 Overview	1193
36.2 Features	1193
36.3 Functional Description	1194
36.3.1 RMT Architecture	1194
36.3.2 RMT RAM	1195
36.3.2.1 Structure of RAM	1195
36.3.2.2 Use of RAM	1195
36.3.2.3 RAM Access	1196
36.3.3 Clock	1196
36.3.4 Transmitter	1196
36.3.4.1 Normal TX Mode	1197
36.3.4.2 Wrap TX Mode	1197
36.3.4.3 TX Modulation	1197
36.3.4.4 Continuous TX Mode	1197
36.3.4.5 Simultaneous TX Mode	1198
36.3.5 Receiver	1198
36.3.5.1 Normal RX Mode	1198
36.3.5.2 Wrap RX Mode	1199
36.3.5.3 RX Filtering	1199
36.3.5.4 RX Demodulation	1199
36.3.6 Configuration Update	1199
36.3.7 Interrupts	1200
36.4 Register Summary	1201
36.5 Registers	1203
37 Parallel IO Controller (PARL_IO)	1218
37.1 Introduction	1218
37.2 Glossary	1218
37.3 Features	1218
37.4 Architectural Overview	1219
37.5 Functional Description	1220
37.5.1 Clock Generator	1220
37.5.2 Clock & Reset Restriction	1220
37.5.3 Master-Slave Mode	1222
37.5.4 Receive Modes of the RX Unit	1222
37.5.4.1 Level Enable Mode	1223
37.5.4.2 Pulse Enable Mode	1223
37.5.4.3 Software Enable Mode	1224
37.5.5 RX Unit GDMA SUC EOF Generation	1225
37.5.6 RX Unit Timeout	1225
37.5.7 Valid Signal Output of TX Unit	1225
37.5.8 Bus Idle Value of TX Unit	1225
37.5.9 Data Transfer in a Single Frame	1226
37.5.10 Bit Reordering in One Byte	1226
37.6 Programming Procedures	1226

37.6.1	Data Receiving Operation Process	1226
37.6.2	Data Transmitting Operation Process	1227
37.7	Application Examples	1227
37.7.1	Co-working with SPI	1228
37.7.2	Co-working with I2S	1229
37.7.3	Co-working with Camera	1230
37.8	Interrupts	1231
37.9	Register Summary	1232
37.10	Registers	1233

38 On-Chip Sensor and Analog Signal Processing 1242

38.1	Overview	1242
38.2	SAR ADC	1242
38.2.1	Overview	1242
38.2.2	Features	1242
38.2.3	Functional Description	1242
38.2.3.1	Input Signals	1244
38.2.3.2	ADC Conversion and Attenuation	1244
38.2.3.3	DIG ADC Controller	1244
38.2.3.4	DMA Support	1245
38.2.3.5	DIG ADC FSM	1245
38.2.3.6	ADC Filters	1248
38.2.3.7	Threshold Monitoring	1248
38.3	Temperature Sensor	1249
38.3.1	Overview	1249
38.3.2	Features	1249
38.3.3	Functional Description	1249
38.4	Event Task Matrix Feature	1251
38.4.1	SAR ADC's ETM Feature	1251
38.4.2	Temperature Sensor's ETM Feature	1251
38.5	Interrupts	1251
38.6	Register Summary	1252
38.7	Registers	1253

39 Related Documentation and Resources 1269

Glossary 1270

Abbreviations for Peripherals	1270
Abbreviations Related to Registers	1270
Access Types for Registers	1272

Programming Reserved Register Field 1274

Introduction	1274
Programming Reserved Register Field	1274

Revision History 1275

List of Tables

1-2	CPU Address Map	36
1-4	Core Local Interrupt (CLINT) Sources	56
1-10	NAPOT encoding for maddress	72
2-2	Trace Encoder Parameters	87
2-3	Header Format	89
2-4	Index Format	89
2-5	Packet format 3 subformat 0	90
2-6	Packet format 3 subformat 1	90
2-7	Packet format 3 subformat 3	91
2-8	Packet format 2	91
2-9	Packet format 1 with address	92
2-10	Packet format 1 without address	93
3-2	LP CPU Exception Causes	110
3-5	Performance Counter	117
3-6	Wake Sources	121
4-1	Selecting Peripherals via Register Configuration	126
4-2	Descriptor Field Alignment Requirements	128
5-1	Memory Address Mapping	163
5-2	Module/Peripheral Address Mapping	167
6-1	Parameters in eFuse BLOCK0	171
6-2	Secure Key Purpose Values	174
6-3	Parameters in BLOCK1 to BLOCK10	175
6-4	Registers Information	180
6-5	Configuration of Default VDDQ Timing Parameters	181
7-1	Bit Used to Control IO MUX Functions in Light-sleep Mode	243
7-2	Peripheral Signals via GPIO Matrix	246
7-3	IO MUX Functions List	251
7-4	LP IO MUX Functions List	252
7-5	Analog Functions of IO MUX Pins	253
8-1	Reset Source	293
8-2	CPU_CLK Clock Source	295
8-3	Frequency of CPU_CLK, AHB_CLK and HP_ROOT_CLK	296
8-4	Derived Clock Source	298
8-5	HP Clocks Used by Each Peripheral	298
8-6	LP Clocks Used by Each Peripheral	299
9-1	Default Configuration of Strapping Pins	362
9-2	Boot Mode Control	362
9-3	ROM Message Printing Control	364
9-4	JTAG Signal Source Control	364
9-5	SDIO Input Sampling Edge/Output Driving Edge Control	365
10-1	CPU Peripheral Interrupt Source Mapping/Status Registers and Peripheral Interrupt Sources	368
11-1	Selectable Events for ETM Channel n	387
11-2	Mappable Tasks for ETM Channel n	390

12-1	UNIT n Configuration Bits	405
12-2	Trigger Point	406
12-3	Synchronization Operation for Configuration Registers	407
13-1	Alarm Generation When Up-Down Counter Increments	429
13-2	Alarm Generation When Up-Down Counter Decrements	430
14-1	Timeout Actions	454
15-1	Management Area of PMP and APM	466
15-2	Configuring Access Path	469
16-1	Security Level	499
17-1	HP CPU Packet Format	515
17-2	LP CPU Packet Format	515
17-3	DMA Packet Format	515
17-4	LOST Packet Format	515
17-5	DMA Access Source	516
18-1	AES Accelerator Working Mode	544
18-2	Key Length and Encryption/Decryption	544
18-3	Working Status under Typical AES Working Mode	545
18-4	Text Endianness Type for Typical AES	545
18-5	Key Endianness Type for AES-128 Encryption and Decryption	546
18-6	Key Endianness Type for AES-256 Encryption and Decryption	546
18-7	Block Cipher Mode	547
18-8	Working Status under DMA-AES Working mode	548
18-9	TEXT-PADDING	548
18-10	Text Endianness for DMA-AES	549
19-1	ECC Accelerator Memory Blocks	558
19-2	ECC Accelerator Key Size Selection	559
19-3	ECC Accelerator's Working Modes	560
20-1	HMAC Purposes and Configuration Value	570
21-1	Acceleration Performance	588
21-2	RSA Accelerator Memory Blocks	589
22-1	SHA Accelerator Working Mode	594
22-2	SHA Hash Algorithm Selection	595
22-3	The Storage and Length of Message Digest from Different Algorithms	598
24-1	Key generated based on Key_A	616
24-2	Mapping Between Offsets and Registers	617
26-1	UART and LP UART Feature Comparison	628
26-2	UART_CHAR_WAKEUP Mode Configuration	637
27-2	Data Modes Supported by GP-SPI2	717
27-3	Functional Description of FSPI Bus Signals	717
27-4	Signals Used in Various SPI Modes	718
27-5	Bit Order Control in GP-SPI2	720
27-6	Supported Transfer Types as Master or Slave	721
27-7	Interrupt Trigger Condition on GP-SPI2 Data Transfer as Slave	725
27-8	Registers Used for State Control in 1/2/4-bit Modes	731
27-8	Registers Used for State Control in 1/2/4-bit Modes	732
27-9	Sending Sequence of Command Value	733

27-10	Sending Sequence of Address Value	734
27-11	BM Table for CONF State	739
27-12	An Example of CONF buffer <i>i</i> in Segment <i>i</i>	740
27-13	BM Bit Value v.s. Register to Be Updated in This Example	740
27-14	Supported CMD Values in SPI Mode	743
27-14	Supported CMD Values in SPI Mode	744
27-15	Supported CMD Values in QPI Mode	744
27-16	Clock Phase and Polarity Configuration as Master	750
27-17	Clock Phase and Polarity Configuration as Slave	750
27-18	GP-SPI2 Interrupts as Master	754
27-19	GP-SPI2 Interrupts as Slave	754
28-1	I2C Synchronous Registers	791
29-2	I2S Signal Description	868
29-3	Bit Width of Channel Valid Data	875
29-4	Endian of Channel Valid Data	875
29-5	The Matching Between Valid Data Width and Number of TX Channel Supported	877
29-6	Data-Fetching Control in PDM Mode	879
29-7	I2S Channel Control in Normal PDM TX Mode	879
29-8	PCM-to-PDM TX Mode	879
29-9	The Matching Between Valid Data Width and Number of RX Channel Supported	881
29-10	Channel Storage Data Width	882
29-11	Channel Storage Data Endian	883
30-1	Counter Mode. Positive Edge of Input Pulse Signal. Control Signal in Low State	907
30-2	Counter Mode. Positive Edge of Input Pulse Signal. Control Signal in High State	907
30-3	Counter Mode. Negative Edge of Input Pulse Signal. Control Signal in Low State	907
30-4	Counter Mode. Negative Edge of Input Pulse Signal. Control Signal in High State	907
31-1	Standard CDC-ACM Control Requests	922
31-2	CDC-ACM Settings with RTS and DTR	923
31-3	Commands of a Nibble	924
31-4	USB-to-JTAG Control Requests	926
31-5	JTAG Capability Descriptors	927
31-6	Reset SoC into Download Mode	928
31-7	Reset SoC into Booting from flash	928
32-1	Data Frames and Remote Frames in SFF and EFF	959
32-2	Error Frame	960
32-3	Overload Frame	961
32-4	Interframe Space	962
32-5	Segments of a Nominal Bit Time	965
32-6	Bit Information of TWAI_BUS_TIMING_0_REG (0x18)	969
32-7	Bit Information of TWAI_BUS_TIMING_1_REG (0x1c)	969
32-8	Buffer Layout for Standard Frame Format and Extended Frame Format	972
32-9	TX/RX Frame Information (SFF/EFF) TWAI Address 0x40	972
32-10	TX/RX Identifier 1 (SFF); TWAI Address 0x44	973
32-11	TX/RX Identifier 2 (SFF); TWAI Address 0x48	973
32-12	TX/RX Identifier 1 (EFF); TWAI Address 0x44	973
32-13	TX/RX Identifier 2 (EFF); TWAI Address 0x48	973

32-14 TX/RX Identifier 3 (EFF); TWAI Address 0x4c	973
32-15 TX/RX Identifier 4 (EFF); TWAI Address 0x50	974
32-16 Bit Information of TWAI_ERR_CODE_CAP_REG (0x30)	979
32-17 Bit Information of Bits SEG.4 - SEG.0	979
32-18 Bit Information of TWAI_ARB_LOST_CAP_REG (0x2c)	980
33-1 SDIO Slave CCCR Configuration	1000
33-2 SDIO Slave FBR Configuration	1001
34-1 Commonly-used Frequencies and Resolutions	1059
35-1 Configuration Parameters of the Operator Submodule	1086
35-2 Timing Events Used in PWM Generator	1097
35-3 Timing Events Priority When PWM Timer Increments	1097
35-4 Timing Events Priority when PWM Timer Decrements	1098
35-5 Dead Time Generator Switches Control Fields	1108
35-6 Typical Dead Time Generator Operating Modes	1108
35-7 MCPWM-Related ETM Events	1115
35-8 ETM Related Tasks	1116
36-1 Configuration Update	1200
38-1 SAR ADC Input Signals	1244
38-2 Temperature Offset	1250

List of Figures

1-1	CPU Block Diagram	35
1-2	Debug System Overview	66
2-1	Trace Encoder Overview	85
2-2	Trace Overview	86
2-3	Trace packet Format	89
3-1	LP CPU Overview	101
3-2	Wake-Up and Sleep Flow of LP CPU	119
4-1	Modules with GDMA Feature and GDMA Channels	123
4-2	GDMA controller Architecture	124
4-3	Structure of a Linked List	125
4-4	Relationship among Linked Lists	127
5-1	System Structure and Address Mapping	162
5-2	Cache Structure	165
5-3	Modules/peripherals that can work with GDMA	166
6-1	Data Flow in eFuse	170
6-2	Shift Register Circuit (first 32 output)	177
6-3	Shift Register Circuit (last 12 output)	177
7-1	Architecture of IO MUX, LP IO MUX, and GPIO Matrix	235
7-2	Internal Structure of a Pad	236
7-3	GPIO Input Synchronized on Rising Edge or on Falling Edge of IO MUX Operating Clock	237
7-4	GPIO Filter Timing of GPIO Input Signals	238
7-5	Glitch Filter Timing Example	238
8-1	Reset Types	292
8-2	System Clock	294
8-3	Clock Configuration Example	301
9-1	Chip Boot Flow	363
10-1	Interrupt Matrix Structure	366
11-1	Event Task Matrix Architecture	386
11-2	ETM Channel n Architecture	387
11-3	Event Task Matrix Clock Architecture	394
12-1	System Timer Structure	403
12-2	System Timer Alarm Generation	404
13-1	Timer Group Overview	427
13-2	Timer Group Architecture	428
14-1	Watchdog Timers Overview	451
14-2	Digital Watchdog Timers in ESP32-C6	453
14-3	Super Watchdog Controller Structure	456
15-1	PMP-APM Management Relation	466
15-2	APM Controller Structure	468
20-1	HMAC SHA-256 Padding Diagram	573
20-2	HMAC Structure Schematic Diagram	573
23-1	Software Preparations and Hardware Working Process	606
24-1	Architecture of the External Memory Encryption and Decryption	615

25-1	Noise Source	626
26-1	UART Structure	629
26-2	UART Controllers Division	632
26-3	The Timing Diagram of Weak UART Signals Along Falling Edges	633
26-4	Structure of UART Data Frame	634
26-5	AT_CMD Character Structure	634
26-6	Driver Control Diagram in RS485 Mode	635
26-7	The Timing Diagram of Encoding and Decoding in SIR mode	636
26-8	IrDA Encoding and Decoding Diagram	637
26-9	Hardware Flow Control Diagram	638
26-10	Connection between Hardware Flow Control Signals	639
26-11	Data Transfer in GDMA Mode	640
26-12	UART Programming Procedures	643
27-1	SPI Module Overview	716
27-2	Data Buffer Used in CPU-Controlled Transfer	721
27-3	GP-SPI2 Block Diagram	726
27-4	Data Flow Control in GP-SPI2 as Master	727
27-5	Data Flow Control in GP-SPI2 as Slave	727
27-6	GP-SPI2 State Machine as Master	730
27-7	Full-Duplex Communication Between GP-SPI2 Master and a Slave	734
27-8	Connection of GP-SPI2 to Flash and External RAM in 4-bit Mode	736
27-9	SPI Quad I/O Read Command Sequence Sent by GP-SPI2 to Flash	737
27-10	Configurable Segmented Transfer as Master	737
27-11	Recommended CS Timing and Settings When Accessing External RAM	747
27-12	Recommended CS Timing and Settings When Accessing Flash	747
27-13	SPI Clock Mode 0 or 2	749
27-14	SPI Clock Mode 1 or 3	749
27-15	Timing Compensation Control Diagram in GP-SPI2 as Master	751
27-16	Timing Compensation Example in GP-SPI2 as Master	752
28-1	I2C Master Architecture	787
28-2	I2C Slave Architecture	787
28-3	I2C Protocol Timing (Cited from Fig.31 in The I2C-bus specification Version 2.1)	788
28-4	I2C Timing Parameters (Cited from Table 5 in The I2C-bus specification Version 2.1)	789
28-5	I2C Timing Diagram	792
28-6	Structure of I2C Command Registers	794
28-7	I2C _{master} Writing to I2C _{slave} with a 7-bit Address	798
28-8	I2C _{master} Writing to a Slave with a 10-bit Address	800
28-9	I2C _{master} Writing to I2C _{slave} with Two 7-bit Addresses	801
28-10	I2C _{master} Writing to I2C _{slave} with a 7-bit Address in Multiple Sequences	803
28-11	I2C _{master} Reading I2C _{slave} with a 7-bit Address	805
28-12	I2C _{master} Reading I2C _{slave} with a 10-bit Address	807
28-13	I2C _{master} Reading N Bytes of Data from addrM of I2C _{slave} with a 7-bit Address	809
28-14	I2C _{master} Reading I2C _{slave} with a 7-bit Address in Segments	812
29-1	ESP32-C6 I2S System Diagram	867
29-2	TDM Philips Standard Timing Diagram	869
29-3	TDM MSB Alignment Standard Timing Diagram	870

29-4	TDM PCM Standard Timing Diagram	870
29-5	PDM Standard Timing Diagram	871
29-6	I2S Clock Generator	871
29-7	TX Data Format Control	877
29-8	TDM Channel Control	878
29-9	PDM Channel Control Example	881
30-1	PCNT Block Diagram	905
30-2	PCNT Unit Architecture	906
30-3	Channel 0 Up Counting Diagram	908
30-4	Channel 0 Down Counting Diagram	909
30-5	Two Channels Up Counting Diagram	909
31-1	USB Serial/JTAG High Level Diagram	921
31-2	USB Serial/JTAG Block Diagram	922
32-1	Bit Fields in Data Frames and Remote Frames	958
32-2	Fields of an Error Frame	960
32-3	Fields of an Overload Frame	961
32-4	The Fields within an Interframe Space	962
32-5	Layout of a Bit	964
32-6	TWAI Overview Diagram	966
32-7	Acceptance Filter	975
32-8	Single Filter Mode	976
32-9	Dual Filter Mode	977
32-10	Error State Transition	978
32-11	Positions of Arbitration Lost Bits	980
33-1	SDIO Slave Block Diagram	998
33-2	CMD52 Content	999
33-3	CMD53 Content	1000
33-4	Function 0 Address Space	1000
33-5	Function 1/2 Address Space Map	1002
33-6	DMA Linked List Descriptor Structure of the SDIO Slave	1004
33-7	DMA Linked List of the SDIO Slave	1005
33-8	Data Flow of Sending Incremental-address Packets From Host to Slave	1006
33-9	Sampling Timing Diagram	1007
33-10	Output Timing Diagram	1008
33-11	Procedure of Slave Sending Packets to Host	1010
33-12	Procedure of Slave Receiving Packets from Host	1012
33-13	Loading Receiving Buffer	1013
34-1	LED PWM Architecture	1055
34-2	Timer and PWM Generator Block Diagram	1056
34-3	Frequency Division When LEDC_CLK_DIV is a Non-Integer Value	1057
34-4	Relationship Between Counter And Resolution	1058
34-5	LED PWM Output Signal Diagram	1059
34-6	Output Signal of Linear Duty Cycle Fading	1062
34-7	Output Signal of Gamma Curve Fading	1063
35-1	MCPWM Module Overview	1082
35-2	Prescaler Module	1085

35-3	Timer Module	1085
35-4	Operator Module	1086
35-5	Fault Detection Module	1087
35-6	Capture Module	1088
35-7	ETM Module	1088
35-8	Count-Up Mode Waveform	1090
35-9	Count-Down Mode Waveforms	1090
35-10	Count-Up-Down Mode Waveforms, Count-Down at Synchronization Event	1090
35-11	Count-Up-Down Mode Waveforms, Count-Up at Synchronization Event	1091
35-12	UTEF and UTEZ Generation in Count-Up Mode	1092
35-13	DTEF and DTEZ Generation in Count-Down Mode	1093
35-14	DTEF and UTEZ Generation in Count-Up-Down Mode	1093
35-15	Block Diagram of A PWM Operator	1095
35-16	Symmetrical Waveform in Count-Up-Down Mode	1099
35-17	Count-Up, Single Edge Asymmetric Waveform, with Independent Modulation on PWMxA and PWMxB — Active High	1100
35-18	Count-Up, Pulse Placement Asymmetric Waveform with Independent Modulation on PWMxA	1101
35-19	Count-Up-Down, Dual Edge Symmetric Waveform, with Independent Modulation on PWMxA and PWMxB — Active High	1102
35-20	Count-Up-Down, Dual Edge Symmetric Waveform, with Independent Modulation on PWMxA and PWMxB — Complementary	1103
35-21	Count-Up-Down, Fault or Synchronization Events, with Same Modulation on PWMxA and PWMxB	1104
35-22	Example of an NCI Software-Force Event on PWMxA	1105
35-23	Example of a CNTU Software-Force Event on PWMxB	1106
35-24	Options for Setting up the Dead Time Generator Module	1108
35-25	Active High Complementary (AHC) Dead Time Waveforms	1109
35-26	Active Low Complementary (ALC) Dead Time Waveforms	1110
35-27	Active High (AH) Dead Time Waveforms	1110
35-28	Active Low (AL) Dead Time Waveforms	1111
35-29	Example of Waveforms Showing PWM Carrier Action	1111
35-30	Example of the First Pulse and the Subsequent Sustaining Pulses of the PWM Carrier Submodule	1112
35-31	Possible Duty Cycle Settings for Sustaining Pulses in the PWM Carrier Submodule	1113
36-1	RMT Architecture	1194
36-2	Format of Pulse Code in RAM	1195
37-1	PARLIO Architecture	1219
37-2	PARLIO Clock Generation	1220
37-3	Master Clock Positive Waveform	1222
37-4	Master Clock Negative Waveform	1222
37-5	Sub-Modes of Level Enable Mode for RX Unit	1223
37-6	Sub-Modes of Pulse Enable Mode for RX Unit	1224
37-7	Sub-Mode of Software Enable Mode for RX Unit	1225
38-1	SAR ADCs Function Overview	1243
38-2	Diagram of DIG ADC FSM	1245
38-3	APB_SARADC_SAR_PATT_TAB1_REG and Pattern Table Entry 0 - Entry 3	1246
38-4	APB_SARADC_SAR_PATT_TAB2_REG and Pattern Table Entry 4 - Entry 7	1246
38-5	Pattern Table Entry	1247

38-6	cmd1 configuration	1247
38-7	cmd0 Configuration	1247
38-8	DMA Data Format	1248
38-9	Temperature Sensor Structure	1249

1 High-Performance CPU

1.1 Overview

ESP-RISC-V CPU is a 32-bit core based upon RISC-V instruction set architecture (ISA) comprising base integer (I), multiplication/division (M), atomic (A) and compressed (C) standard extensions. The core has 4-stage, in-order, scalar pipeline optimized for area, power and performance. CPU core complex has a debug module (DM), interrupt-controller (INTC), core local interrupts (CLINT) and system bus (SYS BUS) interfaces for memory and peripheral access.

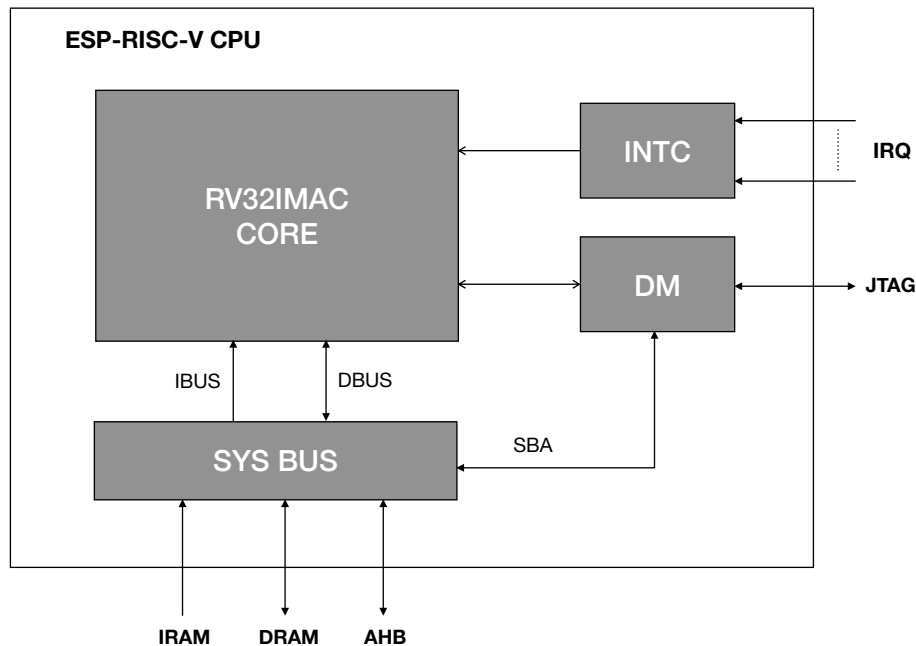

Figure 1-1. CPU Block Diagram

1.2 Features

- RISC-V RV32IMAC ISA with four-stage pipeline that supports an operating clock frequency up to 160 MHz
- Compatible with RISC-V ISA Manual Volume I: Unprivileged ISA Version 2.2 and RISC-V ISA Manual, Volume II: Privileged Architecture, Version 1.10
- Zero wait cycle access to on-chip SRAM and Cache for program and data access over IRAM/DRAM interface
- Branch target buffer (BTB) with static branch prediction
- User (U) mode support along with interrupt delegation
- Interrupt controller with up to 28 external vectored interrupts for both M and U modes with 16 programmable priority and threshold levels
- Core local interrupts (CLINT) dedicated for each privilege mode

- Debug module (DM) compliant with the specification RISC-V External Debug Support Version 0.13 with external debugger support over an industry-standard JTAG/USB port
- Support for instruction trace
- Debugger with a direct system bus access (SBA) to memory and peripherals
- Hardware trigger compliant to the specification RISC-V External Debug Support Version 0.13 with up to 4 breakpoints/watchpoints
- Physical memory protection (PMP) and attributes (PMA) for up to 16 configurable regions
- 32-bit AHB system bus for peripheral access
- Configurable events for core performance metrics

1.3 Terminology

branch	an instruction which conditionally changes the execution flow
delta	a change in the program counter that is other than the difference between two instructions placed consecutively in memory
hart	a RISC-V hardware thread
retire	the final stage of executing an instruction, when the machine state is updated
trap	the transfer of control to a trap handler caused by either an exception or an interrupt

1.4 Address Map

Below table shows address map of various regions accessible by CPU for instruction, data, system bus peripheral and debug.

Table 1-2. CPU Address Map

Name	Description	Starting Address	Ending Address	Access
IRAM/DRAM	Instruction/Data region	0x4000_0000	0x4FFF_FFFF	R/W
CPU	CPU Sub-system region	0x2000_0000	0x2FFF_FFFF	R/W
AHB	AHB Peripheral region	*default	*default	R/W

*default: Address not matching any of the specified ranges (IRAM, DRAM, CPU) are accessed using AHB bus.

1.5 Configuration and Status Registers (CSRs)

1.5.1 Register Summary

Below is a list of CSRs available to the CPU. Except for the custom performance counter CSRs, all the implemented CSRs follow the standard mapping of bit fields as described in the RISC-V Instruction Set Manual, Volume II: Privileged Architecture, Version 1.10. It must be noted that even among the standard CSRs, not all bit fields have been implemented, limited by the subset of features implemented in the CPU. Refer to the next section for detailed description of the subset of fields implemented under each of these CSRs.

Name	Description	Address	Access
Machine Information CSRs			
mvendorid	Machine Vendor ID	0xF11	RO
marchid	Machine Architecture ID	0xF12	RO
mimpid	Machine Implementation ID	0xF13	RO
mhartid	Machine Hart ID	0xF14	RO
Machine Trap Setup CSRs			
mstatus	Machine Mode Status	0x300	R/W
misa ¹	Machine ISA	0x301	R/W
mideleg	Machine Interrupt Delegation Register	0x303	R/W
mie	Machine Interrupt Enable Register	0x304	R/W
mtvec ²	Machine Trap Vector	0x305	R/W
Machine Trap Handling CSRs			
mscratch	Machine Scratch	0x340	R/W
mepc	Machine Trap Program Counter	0x341	R/W
mcause ³	Machine Trap Cause	0x342	R/W
mtval	Machine Trap Value	0x343	R/W
mip	Machine Interrupt Pending	0x344	R/W
User Trap Setup CSRs			
ustatus	User Mode Status	0x000	R/W
uie	User Interrupt Enable Register	0x004	R/W
utvec	User Trap Vector	0x005	R/W
User Trap Handling CSRs			
uscratch	User Scratch	0x040	R/W
uepc	User Trap Program Counter	0x041	R/W
ucause	User Trap Cause	0x042	R/W
uip	User Interrupt Pending	0x044	R/W
Physical Memory Protection (PMP) CSRs			
pmpcfg0	Physical memory protection configuration	0x3A0	R/W
pmpcfg1	Physical memory protection configuration	0x3A1	R/W
pmpcfg2	Physical memory protection configuration	0x3A2	R/W
pmpcfg3	Physical memory protection configuration	0x3A3	R/W
pmpaddr0	Physical memory protection address register	0x3B0	R/W
pmpaddr1	Physical memory protection address register	0x3B1	R/W
....			
pmpaddr15	Physical memory protection address register	0x3BF	R/W
Trigger Module CSRs (shared with Debug Mode)			
tselect	Trigger Select Register	0x7A0	R/W
tdata1	Trigger Abstract Data 1	0x7A1	R/W
tdata2	Trigger Abstract Data 2	0x7A2	R/W
tcontrol	Global Trigger Control	0x7A5	R/W

¹Although [misa](#) is specified as having both read and write access (R/W), its fields are hardwired and thus write has no effect. This is what would be termed WARL (Write Any Read Legal) in RISC-V terminology

²[mtvec](#) only provides configuration for trap handling in vectored mode with the base address aligned to 256 bytes

³External interrupt IDs reflected in [mcause](#) include even those IDs which have been reserved by RISC-V standard for core internal sources.

Name	Description	Address	Access
Debug Mode CSRs			
dcsr	Debug Control and Status	0x7B0	R/W
dpc	Debug PC	0x7B1	R/W
dscratch0	Debug Scratch Register 0	0x7B2	R/W
dscratch1	Debug Scratch Register 1	0x7B3	R/W
Performance Counter CSRs (Custom) ⁴			
mpcer	Machine Performance Counter Event	0x7E0	R/W
mpcmr	Machine Performance Counter Mode	0x7E1	R/W
mpccr	Machine Performance Counter Count	0x7E2	R/W
GPIO Access CSRs (Custom)			
cpu_gpio_oen	GPIO Output Enable	0x803	R/W
cpu_gpio_in	GPIO Input Value	0x804	RO
cpu_gpio_out	GPIO Output Value	0x805	R/W
Physical Memory Attributes Checker (PMAC) CSRs			
pma_cfg0	Physical memory attribute configuration	0xBC0	R/W
pma_cfg1	Physical memory attribute configuration	0xBC1	R/W
pma_cfg2	Physical memory attribute configuration	0xBC2	R/W
pma_cfg3	Physical memory attribute configuration	0xBC3	R/W
....			
pma_cfg15	Physical memory attribute configuration	0xBCF	R/W
pma_addr0	Physical memory attribute address register	0xBD0	R/W
pma_addr1	Physical memory attribute address register	0xBD1	R/W
....			
pma_addr15	Physical memory attribute address register	0xBDF	R/W

Note that if write/set/clear operation is attempted on any of the CSRs which are read-only (RO), as indicated in the above table, the CPU will generate illegal instruction exception.

1.5.2 Register Description

Register 1.1. mvendorid (0xF11)

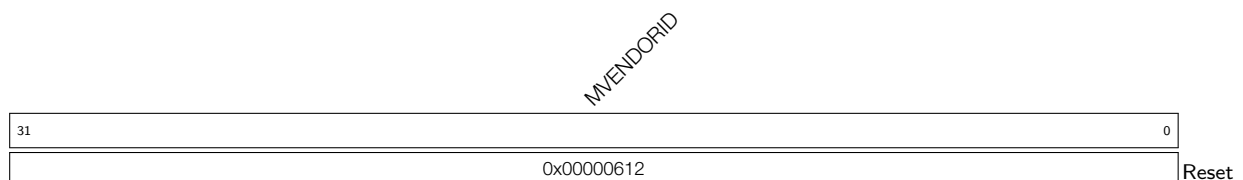

MVENDORID Represents Vendor ID. (RO)

⁴These custom CSRs have been implemented in the address space reserved by RISC-V standard for custom use

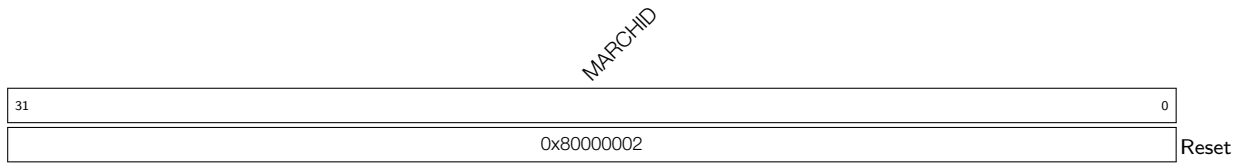
Register 1.2. marchid (0xF12)

MARCHID Represents Architecture ID. (RO)

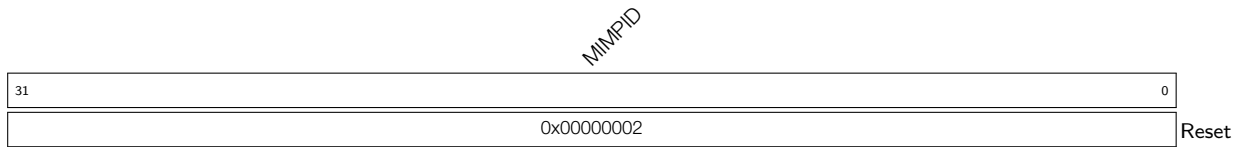
Register 1.3. mimpid (0xF13)

MIMPID Represents Implementation ID. (RO)

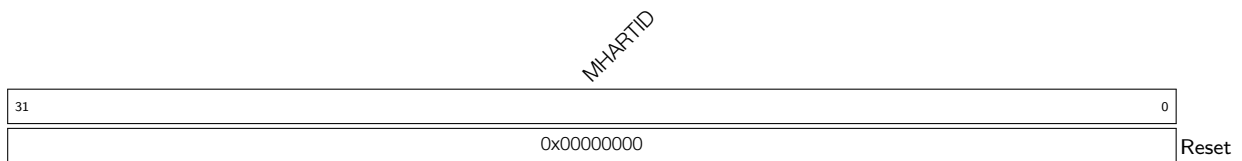
Register 1.4. mhartid (0xF14)

MHARTID Represents Hart ID. (RO)

Register 1.5. mstatus (0x300)

		(reserved)			TW			(reserved)			MPP			(reserved)			MPIE		(reserved)		UPIE		MIE		(reserved)		UIE													
31				22	21	20				13	12	11	10		8	7	6	5	4	3	2	1	0																	
				0x000				0				0x00				0x0				0				0x0				0				0x0				0				Reset

UIE Write 1 to enable the global user mode interrupt. (R/W)

MIE Write 1 to enable the global machine mode interrupt. (R/W)

UPIE Write 1 to enable the user previous interrupt (before trap). (R/W)

MPIE Write 1 to enable the machine previous interrupt (before trap). (R/W)

MPP Configures machine previous privilege mode (before trap).

0x0: User mode

0x3: Machine mode

Note: Only the lower bit is writable. Any write to the higher bit is ignored as it is directly tied to the lower bit.

(R/W)

TW Configures whether to cause illegal instruction exception when WFI (Wait-for-Interrupt) instruction is executed in U mode.

0: Not cause illegal exception in U mode

1: Cause illegal instruction exception

(R/W)

Register 1.6. *misa* (0x301)

MXL		(reserved)		Z	Y	X	W	V	U	T	S	R	Q	P	O	N	M	L	K	J	I	H	G	F	E	D	C	B	A
31	30	29	26	25	24	23	22	21	20	19	18	17	16	15	14	13	12	11	10	9	8	7	6	5	4	3	2	1	0
0x1		0x0		0	0	0	0	0	1	0	0	0	0	0	0	0	1	0	0	0	1	0	0	0	0	0	1	0	1

Reset

- MXL** Machine XLEN = 1 (32-bit). (RO)
- Z** Reserved = 0. (RO)
- Y** Reserved = 0. (RO)
- X** Non-standard extensions present = 0. (RO)
- W** Reserved = 0. (RO)
- V** Reserved = 0. (RO)
- U** User mode implemented = 1. (RO)
- T** Reserved = 0. (RO)
- S** Supervisor mode implemented = 0. (RO)
- R** Reserved = 0. (RO)
- Q** Quad-precision floating-point extension = 0. (RO)
- P** Reserved = 0. (RO)
- O** Reserved = 0. (RO)
- N** User-level interrupts supported = 0. (RO)
- M** Integer Multiply/Divide extension = 1. (RO)
- L** Reserved = 0. (RO)
- K** Reserved = 0. (RO)
- J** Reserved = 0. (RO)
- I** RV32I base ISA = 1. (RO)
- H** Hypervisor extension = 0. (RO)
- G** Additional standard extensions present = 0. (RO)
- F** Single-precision floating-point extension = 0. (RO)
- E** RV32E base ISA = 0. (RO)
- D** Double-precision floating-point extension = 0. (RO)
- C** Compressed Extension = 1. (RO)
- B** Reserved = 0. (RO)
- A** Atomic Extension = 1. (RO)

Register 1.7. mideleg (0x303)

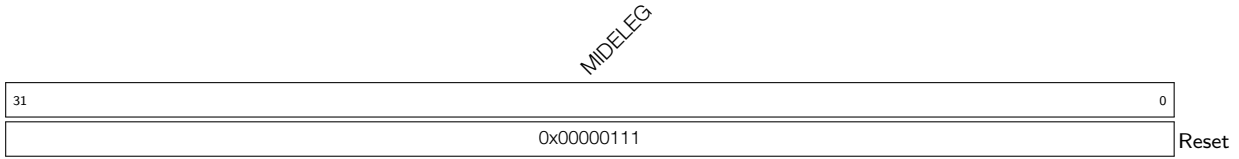

MIDELEG Configures the U mode delegation state for each interrupt ID. Below interrupts are delegated to U mode by default:

Bit 0: User software interrupt (CLINT)

Bit 4: User timer interrupt (CLINT)

Bit 8: User external interrupt

The default delegation can be modified at run-time if required.

(R/W)

Register 1.8. mie (0x304)

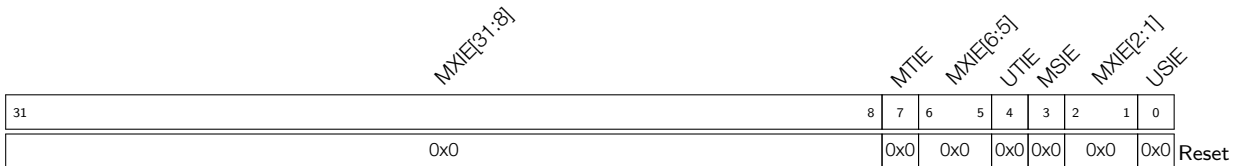

USIE Write 1 to enable the user software interrupt. (R/W)

MSIE Write 1 to enable the machine software interrupt. (R/W)

UTIE Write 1 to enable the user timer interrupt. (R/W)

MTIE Write 1 to enable the machine timer interrupt. (R/W)

MXIE Write 1 to enable the 28 external interrupts. (R/W)

Register 1.9. mtvec (0x305)



MODE Represents whether machine mode interrupts are vectored. Only vectored mode **0x1** is available. (RO)

BASE Configures the higher 24 bits of trap vector base address aligned to 256 bytes. (R/W)

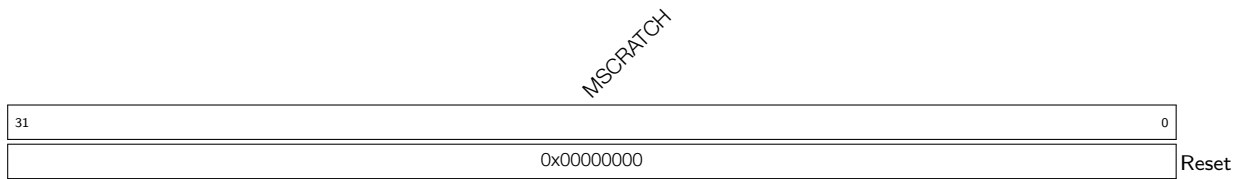
Register 1.10. mscratch (0x340)

MSCRATCH Configures machine scratch information for custom use. (R/W)

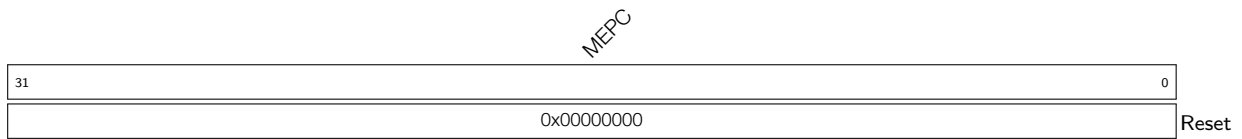
Register 1.11. mepc (0x341)

MEPC Configures the machine trap/exception program counter. This is automatically updated with address of the instruction which was about to be executed while CPU encountered the most recent trap. (R/W)

Register 1.12. mcause (0x342)

31	30	5	4	0
Interrupt Flag		(reserved)		Exception Code
0	0x0000000			0x00
				Reset

Exception Code This field is automatically updated with unique ID of the most recent exception or interrupt due to which CPU entered trap. Possible exception IDs are:

- 0x1: PMP instruction access fault
- 0x2: Illegal instruction
- 0x3: Hardware breakpoint/watchpoint or EBREAK
- 0x5: PMP load access fault
- 0x6: Misaligned store address or AMO address
- 0x7: PMP store access or AMO access fault
- 0x8: ECALL from U mode
- 0xb: ECALL from M mode
- Other values: reserved

Note: Exception ID 0x0 (instruction access misaligned) is not present because CPU always masks the lowest bit of the address during instruction fetch.

(R/W)

Interrupt Flag This flag is automatically updated when CPU enters trap.

If this is found to be set, indicates that the latest trap occurred due to an interrupt. For exceptions it remains unset.

Note: The interrupt controller is using up IDs in range 1-2, 5-6 and 8-31 for all external interrupt sources. This is different from the RISC-V standard which has reserved IDs in range 0-15 for core local interrupts only. Although local interrupt sources (CLINT) do use the reserved IDs 0, 3, 4 and 7.

(R/W)

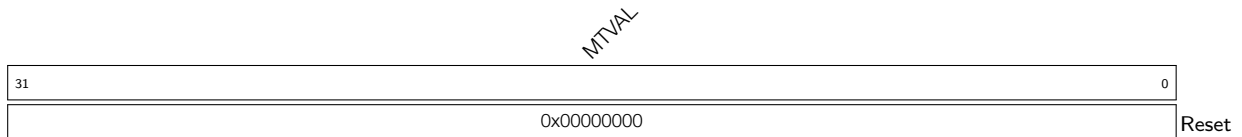
Register 1.13. mtval (0x343)

MTVAL Configures machine trap value. This is automatically updated with an exception dependent data which may be useful for handling that exception.

Data is to be interpreted depending upon exception IDs:

0x1: Faulting virtual address of instruction

0x2: Faulting instruction opcode

0x5: Faulting data address of load operation

0x7: Faulting data address of store operation

Note: The value of this register is not valid for other exception IDs and interrupts.

(R/W)

Register 1.14. mip (0x344)

31	<i>MXIP[31:8]</i>								8	7	6	5	4	3	2	1	0	
0x0										0x0	0x0	0x0	0x0	0x0	0x0	0x0	0x0	Reset
				<i>MTIP</i>		<i>MXIP[6:5]</i>	<i>UTIP</i>	<i>MSIP</i>		<i>MXIP[2:1]</i>	<i>USIP</i>							

USIP Configures the pending status of the user software interrupt.

0: Not pending

1: Pending

(R/W)

MSIP Configures the pending status of the machine software interrupt.

0: Not pending

1: Pending

(R/W)

UTIP Configures the pending status of the user timer interrupt.

0: Not pending

1: Pending

(R/W)

MTIP Configures the pending status of the machine timer interrupt.

0: Not pending

1: Pending

(R/W)

MXIP Configures the pending status of the 28 external interrupts.

0: Not pending

1: Pending

(R/W)

Register 1.15. ustatus (0x300)

31	<i>(reserved)</i>				5	4	3	1	0	
0x0000000							0	0x0	0	Reset
						<i>UPIE</i>	<i>(reserved)</i>	<i>UIE</i>		

UIE Write 1 to enable the global user mode interrupt. (R/W)

UPIE Write 1 to enable the user previous interrupt (before trap). (R/W)

Register 1.16. uie (0x004)

31									8	7	6	5	4	3	2	1	0		
<i>UXIE[31:9]</i>										<i>(reserved)</i>			<i>UXIE[6:5]</i>		<i>UTIE</i>	<i>(reserved)</i>		<i>UXIE[2:1]</i>	<i>USIE</i>
0x0										0x0	0x0	0x0	0x0	0x0	0x0	0x0	Reset		

USIE Write 1 to enable the user software interrupt. (R/W)

UTIE Write 1 to enable the user timer interrupt. (R/W)

UXIE Write 1 to enable the 28 external interrupts delegated to U mode. (R/W)

Register 1.17. utvec (0x005)

31							8	7			2	1	0
<i>BASE</i>								<i>(reserved)</i>			<i>MODE</i>		
0x000000								0x00			0x1		Reset

MODE Represents if user mode interrupts are vectored. Only vectored mode **0x1** is available. (RO)

BASE Configures the higher 24 bits of trap vector base address aligned to 256 bytes. (R/W)

Register 1.18. uscratch (0x040)

31																																0	
<i>USCRATCH</i>																																	
0x00000000																																	Reset

USCRATCH Configures user scratch information for custom use. (R/W)

Register 1.19. uepc (0x041)

31																																0	
<i>UEPC</i>																																	
0x00000000																																	Reset

UEPC Configures the user trap program counter. This is automatically updated with address of the instruction which was about to be executed in User mode while CPU encountered the most recent user mode interrupt. (R/W)

Register 1.20. ucause (0x042)

Interrupt Flag	(reserved)	Exception Code
31	30	5 4 0
0x00000000		0x00
		Reset

Interrupt ID This field is automatically updated with the unique ID of the most recent user mode interrupt due to which CPU entered trap. (R/W)

Interrupt Flag This flag would always be set because CPU can only enter trap due to user mode interrupts as exception delegation is unsupported. (R/W)

Register 1.21. uip (0x044)

UXIP[31:8]	(reserved)	UXIP[5:4]	UTIP	(reserved)	UXIP[2:1]	USIP			
31	8	7	6	5	4	3	2	1	0
0x0		0x0	0x0	0x0	0x0	0x0	0x0	0x0	0x0
		Reset							

USIP Configures the pending status of the user software interrupt.

0: Not pending

1: Pending

(R/W)

UTIP Configures the pending status of the user timer interrupt.

0: Not pending

1: Pending

(R/W)

UXIP Configures the pending status of the 28 external interrupts delegated to user mode.

0: Not pending

1: Pending

(R/W)

Register 1.22. mpcer (0x7E0)

(reserved)											INST_COMP	(BRANCH_TAKEN)	BRANCH	JMP_UNCOND	STORE	LOAD	IDLE	JMP_HAZARD	LD_HAZARD	INST	CYCLE		
31											11	10	9	8	7	6	5	4	3	2	1	0	
0x000											0	0	0	0	0	0	0	0	0	0	0	0	Reset

INST_COMP Count Compressed Instructions. (R/W)

BRANCH_TAKEN Count Branches Taken. (R/W)

BRANCH Count Branches. (R/W)

JMP_UNCOND Count Unconditional Jumps. (R/W)

STORE Count Stores. (R/W)

LOAD Count Loads. (R/W)

IDLE Count IDLE Cycles. (R/W)

JMP_HAZARD Count Jump Hazards. (R/W)

LD_HAZARD Count Load Hazards. (R/W)

INST Count Instructions. (R/W)

CYCLE Count Clock Cycles. Cycle count does not increment during WFI mode.

Note: Each bit selects a specific event for counter to increment. If more than one event is selected and occurs simultaneously, then counter increments by one only.

(R/W)

Register 1.23. mpcmr (0x7E1)

(reserved)											COUNT_SAT		COUNT_EN		
31											2	1	0		
0											1	1	Reset		

COUNT_SAT Configures counter saturation.

0: Overflow on maximum value

1: Halt on maximum value

(R/W)

COUNT_EN Configures whether to enable the counter.

0: Disable

1: Enable

(R/W)

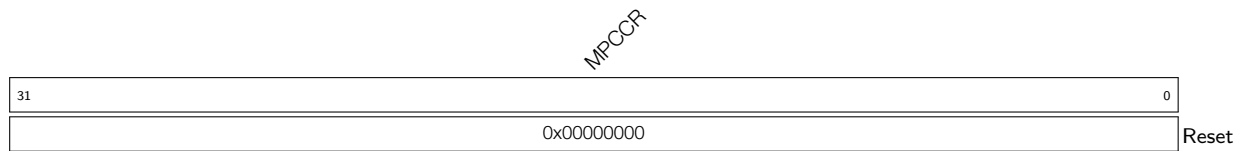
Register 1.24. mpccr (0x7E2)

MPCCR Represents the machine performance counter value. (R/W)

1.6 Interrupt Controller

1.6.1 Features

The interrupt controller allows capturing, masking and dynamic prioritization of interrupt sources routed from peripherals to the RISC-V CPU. It supports:

- Up to 28 external asynchronous interrupts and 4 core local interrupt sources (CLINT) with unique IDs (0-31)
- Configurable via read/write to memory mapped registers
- Delegable to user mode
- 15 levels of priority, programmable for each interrupt
- Support for both level and edge type interrupt sources
- Programmable global threshold for masking interrupts with lower priority
- Interrupts IDs mapped to trap-vector address offsets

For the complete list of interrupt registers and detailed configuration information, please refer to Chapter 10 [Interrupt Matrix \(INTMTX\)](#) > Section 10.4.2.

1.6.2 Functional Description

Each interrupt ID has 6 properties associated with it. These properties can be configured for the 28 external interrupts (1-2, 5-6, 8-31), but are static (except mode) for the 4 local CLINT interrupts (0, 3, 4, 7). These properties are as follows:

1. Mode (M/U):

- Determines the mode in which an interrupt is to be serviced.
- Programmed by setting or clearing the corresponding bit in [mideleg](#) CSR.
- If the bit is cleared for an interrupt in [mideleg](#) CSR, then that interrupt will be captured in M mode.
- If the bit is set for an interrupt in [mideleg](#) CSR, then it will be delegated to U mode.

2. Enable State (0-1):

- Determines if an interrupt is enabled to be captured and serviced by the CPU.
- Programmed by writing the corresponding bit in [INTPRI_CORE0_CPU_INT_ENABLE_REG](#).
- Local CLINT interrupts have the corresponding bits reserved in the memory mapped registers thus they are always enabled at the INTC level.
- An M mode interrupt (external or local) further needs to be unmasked at core level by setting the corresponding bit in [mie](#) CSR.
- A U mode interrupt (external or local) further needs to be unmasked at core level by setting the corresponding bits in [uie](#) CSR.

3. Type (0-1):

- Enables latching the state of an interrupt signal on its rising edge.
- Programmed by writing the corresponding bit in [INTPRI_CORE0_CPU_INT_TYPE_REG](#).

- An interrupt for which type is kept 0 is referred as a 'level' type interrupt.
- An interrupt for which type is set to 1 is referred as an 'edge' type interrupt.
- Local CLINT interrupts are always 'level' type and thus have the corresponding bits reserved in the above register.

4. Priority (0-15):

- Determines which interrupt, among multiple pending interrupts, the CPU will service first.
- Programmed by writing to the [INTPRI_CORE0_CPU_INT_PRI_n_REG](#) for an external interrupt with particular interrupt ID *n*.
- Enabled external interrupts with priorities less than the threshold value in [INTPRI_CORE0_CPU_INT_THRESH_REG](#) are masked.
- Priority levels increase from 0 (lowest) to 15 (highest).
- Interrupts with same priority are statically prioritized by their IDs, lowest ID having highest priority.
- Local CLINT interrupts have static priorities associated with them, and thus have the corresponding priority registers to be reserved.
- Local CLINT interrupts cannot be masked using the threshold values for either modes.

5. Pending State (0-1):

- Reflects the captured state of an enabled and unmasked external interrupt signal.
- For each external interrupt ID the corresponding bit in read-only [INTPRI_CORE0_CPU_INT_EIP_STATUS_REG](#) gives its pending state.
- For each interrupt ID (local or external), the corresponding bit in the [mip](#) CSR for M mode interrupts or [uip](#) CSR for U mode interrupts, also gives its pending state.
- A pending interrupt will cause CPU to enter trap if no other pending interrupt has higher priority.
- A pending interrupt is said to be 'claimed' if it preempts the CPU and causes it to jump to the corresponding trap vector address.
- All pending interrupts which are yet to be serviced are termed as 'unclaimed'.

6. Clear State (0-1):

- Toggling this will clear the pending state of claimed edge-type interrupts only.
- Toggled by first setting and then clearing the corresponding bit in [INTPRI_CORE0_CPU_INT_CLEAR_REG](#).
- Pending state of a level type interrupt is unaffected by this and must be cleared from source.
- Pending state of an unclaimed edge type interrupt can be flushed, if required, by first clearing the corresponding bit in [INTPRI_CORE0_CPU_INT_ENABLE_REG](#) and then toggling same bit in [INTPRI_CORE0_CPU_INT_CLEAR_REG](#).

For detailed description of the core local interrupt sources, please refer to Section 1.7.

When CPU services a pending M/U mode interrupt, it:

- saves the address of the current un-executed instruction in [mepc/uepc](#) for resuming execution later.

- updates the value of `mcause/ucause` with the ID of the interrupt being serviced.
- copies the state of `MIE/UIE` into `MPIE/UPIE`, and subsequently clears `MIE/UIE`, thereby disabling interrupts globally.
- enters trap by jumping to a word-aligned offset of the address stored in `mtvec/utvec`.

The word aligned trap address for an M mode interrupt with a certain $ID = i$ can be calculated as $(mtvec + 4i)$. Similarly, the word aligned trap address for a U mode interrupt can be calculated as $(utvec + 4i)$.

After jumping to the trap vector for the corresponding mode, the execution flow is dependent on software implementation, although it can be presumed that the interrupt will get handled (and cleared) in some interrupt service routine (ISR) and later the normal execution will resume once the CPU encounters MRET/URET instruction for that mode.

Upon execution of MRET/URET instruction, the CPU:

- copies the state of `MPIE/UPIE` back into `MIE/UIE`, and subsequently clears `MPIE/UPIE`. This means that if previously `MPIE/UPIE` was set, then, after MRET/URET, `MIE/UIE` will be set, thereby enabling interrupts globally.
- jumps to the address stored in `mepc/uepc` and resumes execution.

It is possible to perform software assisted nesting of interrupts inside an ISR as explained in Section 1.6.3.

The below listed points outline the functional behavior of the controller:

- Only if an interrupt has priority higher or equal to the value in the threshold register, will it be reflected in `INTPRI_CORE0_CPU_INT_EIP_STATUS_REG`.
- If an interrupt is visible in `INTPRI_CORE0_CPU_INT_EIP_STATUS_REG` and has yet to be serviced, then it's possible to mask it (and thereby prevent the CPU from servicing it) by either lowering the value of its priority or increasing the global threshold.
- If an interrupt, visible in `INTPRI_CORE0_CPU_INT_EIP_STATUS_REG`, is to be flushed (and prevented from being serviced at all), then it must be disabled (and cleared if it is of edge type).

1.6.3 Suggested Operation

1.6.3.1 Latency Aspects

There is latency involved while configuring the Interrupt Controller.

In steady state operation, the Interrupt Controller has a fixed latency of 4 cycles. Steady state means that no changes have been made to the Interrupt Controller registers recently. This implies that any interrupt that is asserted to the controller will take exactly 4 cycles before the CPU starts processing the interrupt. This further implies that CPU may execute up to 5 instructions before the preemption happens.

Whenever any of its registers are modified, the Interrupt Controller enters into transient state, which may take up to 4 cycles for it to settle down into steady state again. During this transient state, the ordering of interrupts may not be predictable, and therefore, a few safety measures need to be taken in software to avoid any synchronization issues.

Also, it must be noted that the Interrupt Controller configuration registers lie in the APB address range, hence any R/W access to these registers may take multiple cycles to complete.

In consideration of above mentioned characteristics, users are advised to follow the sequence described below, whenever modifying any of the Interrupt Controller registers:

1. save the state of [MIE](#) and clear [MIE](#) to 0
2. read-modify-write one or more Interrupt Controller registers
3. execute FENCE instruction to wait for any pending write operations to complete
4. finally, restore the state of [MIE](#)

Due to its critical nature, it is recommended to disable interrupts globally ([MIE=0](#)) beforehand, whenever configuring interrupt controller registers, and then restore [MIE](#) right after, as shown in the sequence above.

After execution of the sequence above, the Interrupt Controller will resume operation in steady state.

1.6.3.2 Configuration Procedure

By default, interrupts are disabled globally, since the reset value of [MIE](#) bit in [mstatus](#) is 0. Software must set [MIE=1](#) after initialization of the interrupt stack (including setting [mtvec](#) to the interrupt vector address) is done.

The threshold value for external interrupts in [INTPRI_CORE0_CPU_INT_THRESH_REG](#) is 0 by default. For priority based masking of interrupts this could be initialized to 1 after CPU comes out of reset. That way all interrupt sources which have default 0 priority are masked.

During normal execution, if an external interrupt n is to be enabled, the below sequence may be followed:

1. save the state of [MIE](#) and clear [MIE](#) to 0
2. depending upon the type of the interrupt (edge/level), set/unset the n th bit of [INTPRI_CORE0_CPU_INT_TYPE_REG](#)
3. set the priority by writing a value to [INTPRI_CORE0_CPU_INT_PRI_n_REG](#) in range 1 (lowest) to 15 (highest)
4. set the n th bit of [INTPRI_CORE0_CPU_INT_ENABLE_REG](#)
5. execute FENCE instruction
6. restore the state of [MIE](#)

When one or more interrupts become pending, the CPU acknowledges (claims) the interrupt with the highest priority and jumps to the trap vector address corresponding to the interrupt's ID. Software implementation may read [mcause](#) to infer the type of trap ([mcause\(31\)](#) is 1 for interrupts and 0 for exceptions) and then the ID of the interrupt ([mcause\(4-0\)](#) gives ID of interrupt or exception). This inference may not be necessary if each entry in the trap vector are jump instructions to different trap handlers. Ultimately, the trap handler(s) will redirect execution to the appropriate ISR for this interrupt.

Upon entering into an ISR, software must toggle the n th bit of [INTPRI_CORE0_CPU_INT_CLEAR_REG](#) if the interrupt is of edge type, or clear the source of the interrupt if it is of level type.

Software may also update the value of [INTPRI_CORE0_CPU_INT_THRESH_REG](#) and program [MIE=1](#) for allowing higher priority interrupts to preempt the current ISR (nesting), however, before doing so, all the state CSRs must be saved ([mepc](#), [mstatus](#), [mcause](#), etc.) since they will get overwritten due to occurrence of such an interrupt. Later, when exiting the ISR, the values of these CSRs must be restored.

Finally, after the execution returns from the ISR back to the trap handler, MRET instruction is used to resume normal execution.

Later, if the n interrupt is no longer needed and needs to be disabled, the following sequence may be followed:

1. save the state of MIE and clear MIE to 0
2. check if the interrupt is pending in `INTPRI_CORE0_CPU_INT_EIP_STATUS_REG`
3. set/unset the n th bit of `INTPRI_CORE0_CPU_INT_ENABLE_REG`
4. if the interrupt is of edge type and was found to be pending in step 2 above, n th bit of `INTPRI_CORE0_CPU_INT_CLEAR_REG` must be toggled, so that its pending status gets flushed
5. execute FENCE instruction
6. restore the state of MIE

Above is only a suggested scheme of operation. Actual software implementation may vary.

1.6.4 Registers

For the complete list of interrupt registers and configuration information, please refer to Section [10.4.2](#) and Section [10.5.2](#) respectively.

1.7 Core Local Interrupts (CLINT)

1.7.1 Overview

The CPU supports 4 local level-type interrupt sources with static priorities as shown below.

Table 1-4. Core Local Interrupt (CLINT) Sources

ID	Description	Priority
0	U mode software interrupt	1
3	M mode software interrupt	3
4	U mode timer interrupt	0
7	M mode timer interrupt	2

These interrupt sources have reserved IDs and fixed priorities which cannot be masked via the interrupt controller threshold registers for either modes.

Two of these interrupts (0 and 4) are by-default delegated to U mode as per the reset values of corresponding bits in [mideleg](#) CSR.

It must be noted that regardless of the fixed priority of CLINT interrupts, pending external interrupt sources always have higher priority over CLINT sources.

1.7.2 Features

- 4 local level-type interrupt sources with static priorities and IDs
- Memory mapped configuration and status registers
- Support for interrupts in both M and U modes
- 64-bit timer with interrupt with overflow flag
- Software interrupts

1.7.3 Software Interrupt

M and U mode software interrupt sources are controlled by setting or clearing the memory mapped registers [MSIP](#) and [USIP](#), respectively.

The [MSIE/USIE](#) bit must be set in [mie/uiie](#) CSR for enabling the interrupt at core level for a particular mode.

Pending state of this interrupt can be checked for either mode by reading the corresponding bit [MSIP/USIP](#) in [mip/uiip](#) CSR.

Note that by default U mode software interrupt with ID 0 has the corresponding bit set in [mideleg](#) CSR. This bit can be toggled for using the interrupt in M mode instead. Similarly the bit corresponding to M mode software interrupt can be set for using it in U mode.

1.7.4 Timer Counter and Interrupt

The CPU provides a local memory-mapped 64-bit wide M mode timer counter register [MTIME](#) which has both read/write access. The timer counter can be enabled by setting the [MTCE](#) bit in [MTIMECTL](#).

A read-only memory mapped [UTIME](#) is also provided for reading the timer counter from U mode, although it always reflects the same value as in the corresponding M mode counter [MTIME](#) register.

Timer interrupt for M/U mode is enabled by setting the [MTIE/UTIE](#) bit in [MTIMECTL/UTIMECTL](#). Also, the [MTIE/UTIE](#) bit must be set in [mie](#) CSR for enabling the interrupt at core level for a particular mode.

Interrupt for M/U mode is asserted when the 64b timer value exceeds the 64b timer-compare value programmed in [MTIMECMP/UTIMECMP](#).

Pending state of M/U mode timer interrupt is reflected as the read-only [MTIP/UTIP](#) bit in [MTIMECTL/UTIMECTL](#).

For de-asserting the pending timer interrupt in M/U mode, either the [MTIE/UTIE](#) bit has to be cleared or the value of the [MTIMECMP/UTIMECMP](#) register needs to be updated.

Pending state of this interrupt can be checked at core level for either mode by reading the corresponding bit [MTIP/UTIP](#) in [mip/uip](#).

Upon overflow of the 64b timer counter, the [MTOF/UTOF](#) bit in [MTIMECTL/UTIMECTL](#) gets set. It can be cleared after appropriate handling of the overflow situation.

Note that by default U mode timer interrupt with ID 4 has the corresponding bit set in [mideleg](#) CSR. This bit can be toggled for using the interrupt in M mode instead. Similarly the bit corresponding to M mode timer interrupt can be set for using it in U mode.

1.7.5 Register Summary

The addresses in this section are relative to CPU sub-system base address provided in Figure 5-1 in Chapter 5 *System and Memory*.

Name	Description	Address	Access
MSIP	Core local machine software interrupt pending register	0x1800	R/W
MTIMECTL	Core local machine timer interrupt control/status register	0x1804	R/W
MTIME	64b core local timer counter value	0x1808	R/W
MTIMECMP	64b core local machine timer compare value	0x1810	R/W
USIP	Core local user software interrupt pending register	0x1C00	R/W
UTIMECTL	Core local user timer interrupt control/status register	0x1C04	R/W
UTIME	Read-only 64b core local timer counter value	0x1C08	RO
UTIMECMP	64b core local user timer compare value	0x1C10	R/W

1.7.6 Register Description

The addresses in this section are relative to CPU subsystem base address provided in Figure 5-1 in Chapter 5 *System and Memory*.

Register 1.25. MSIP (0x1800)

31	<i>(reserved)</i>	1	0	<i>MSIP</i>
0x00000000				0 Reset

MSIP Configures the pending status of the machine software interrupt.

- 0: Not pending
 - 1: Pending
- (R/W)

Register 1.26. MTIMECTL (0x1804)

31	<i>(reserved)</i>	4	3	2	1	0	<i>MTOF</i> <i>MTIP</i> <i>MTIE</i> <i>MTCE</i>
0x00000000							0 0 0 0 Reset

MTCE Configures whether to enable the CLINT timer counter.

- 0: Not enable
 - 1: Enable
- (R/W)

MTIE Write 1 to enable the machine timer interrupt. (R/W)

MTIP Represents the pending status of the machine timer interrupt.

- 0: Not pending
 - 1: Pending
- (RO)

MTOF Configures whether the machine timer overflows.

- 0: Not overflow
 - 1: Overflow
- (R/W)

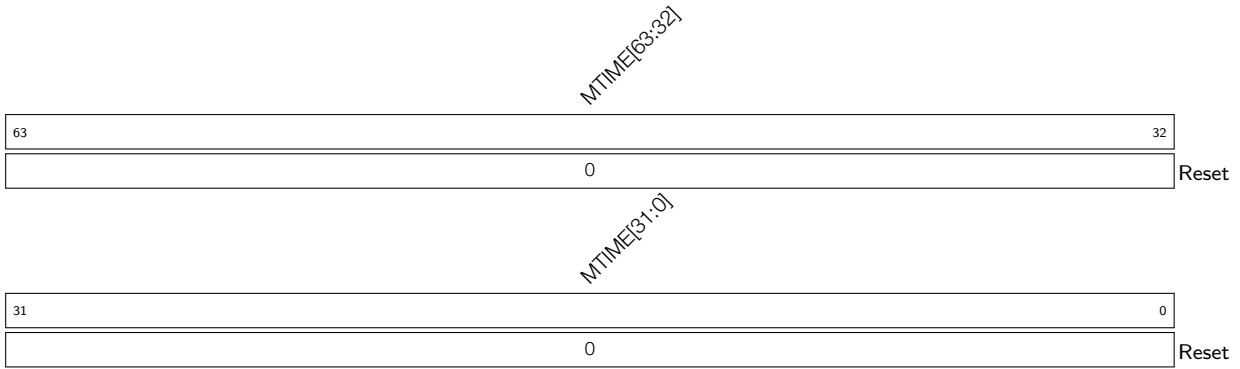
Register 1.27. MTIME (0x1808)

MTIME Configures the 64-bit CLINT timer counter value. (R/W)

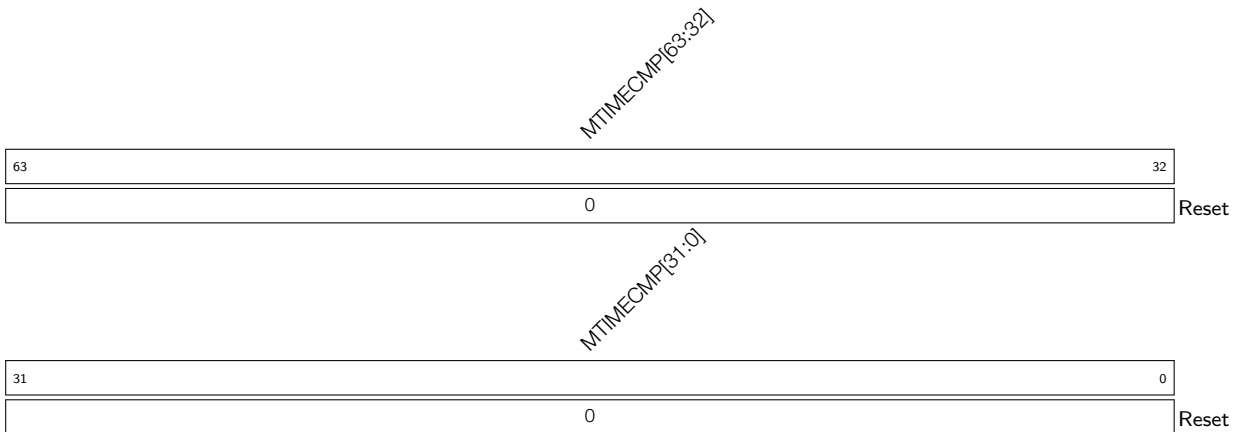
Register 1.28. MTIMECMP (0x1810)

MTIMECMP Configures the 64-bit machine timer compare value. (R/W)

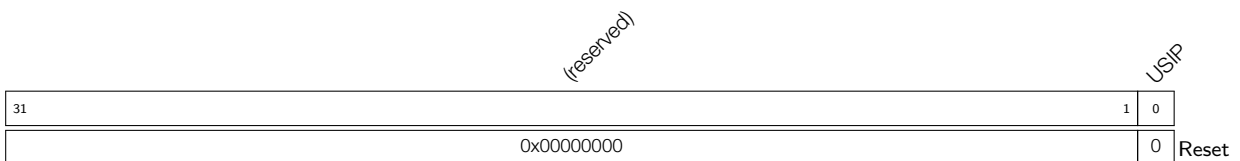
Register 1.29. USIP (0x1C00)

USIP Configures the pending status of the user software interrupt.

0: Not pending

1: Pending

(R/W)

Register 1.30. UTIMECTL (0x1C04)

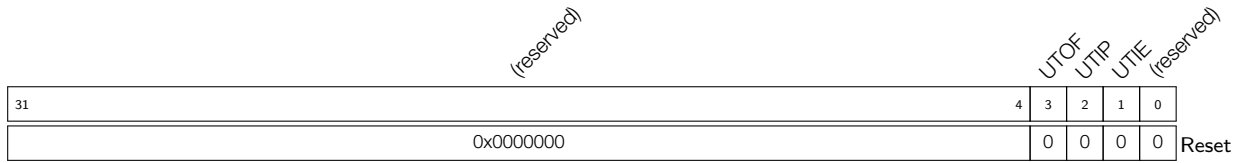

UTIE Write 1 to enable the user timer interrupt. (R/W)

UTIP Represents the pending status of the user timer interrupt. (RO)

UTOF Configures whether the user timer overflows.

0: Not overflow

1: Overflow

(R/W)

Register 1.31. UTIME (0x1C08)

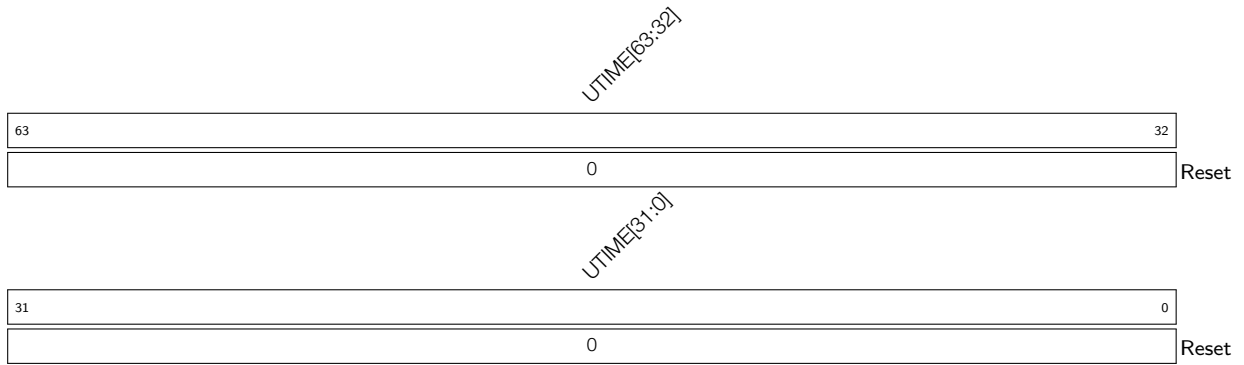

UTIME Represents the read-only 64-bit CLINT timer counter value. (RO)

Register 1.32. UTIMECMP (0x1C10)

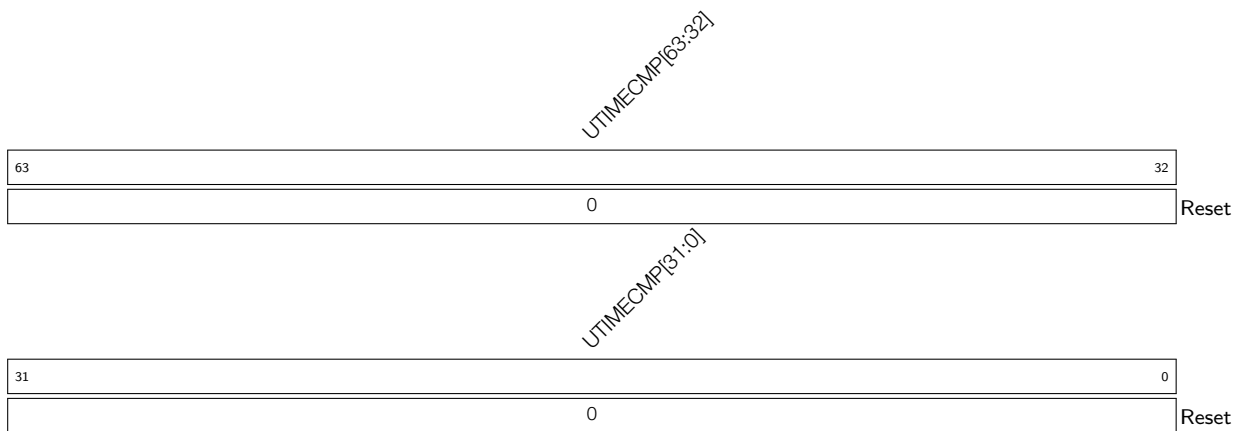

UTIMECMP Configures the 64-bit user timer compare value. (R/W)

1.8 Physical Memory Protection

1.8.1 Overview

The CPU core includes a Physical Memory Protection (PMP) unit fully compliant to **RISC-V Instruction Set Manual, Volume II: Privileged Architecture, Version 1.10**, which can be used by software to set memory access privileges (read, write and execute permissions) for required memory regions. In addition to standard PMP checks, CPU core also implements custom Physical Memory Attributes (PMA) checkers to provide additional permission checks based on pre-defined attributes.

1.8.2 Features

The PMP unit can be used to restrict access to physical memory. It supports 16 regions and a minimum granularity of 4 bytes. Maximum supported NAPOT range is 4 GB.

1.8.3 Functional Description

Software can program the PMP unit's configuration and address registers in order to contain faults and support secure execution. PMP CSRs can only be programmed in machine-mode. Once the PMP unit is enabled by configuring PMP CSRs, write, read and execute permission checks are applied to all the accesses in user-mode as per programmed values of enabled 16 `pmpcfgX` and `pmpaddrX` registers (refer to the Register summary [Register Summary](#)).

By default, PMP grants permission to all accesses in machine-mode and revokes permission of all access in user-mode. This implies that it is mandatory to program the address range and valid permissions in `pmpcfg` and `pmpaddr` registers (refer to the Register summary [Register Summary](#)) for any valid access to pass through in user-mode. However, it is not required for machine-mode as PMP permits all accesses to go through by default. In cases where PMP checks are also required in machine-mode, software can set the lock bit of required PMP entry to enable permission checks on it. Once the lock bit is set, it can only be cleared through CPU reset.

When any instruction is being fetched from a memory region without execute permissions, an exception is generated at processor level and exception cause is set as instruction access fault in `mcause` CSR. Similarly, any load/store access without valid read/write permissions, will result in an exception generation with `mcause` updated as load access and store access fault respectively. In case of load/store access faults, violating address is captured in `mtval` CSR.

1.8.4 Register Summary

Below is a list of PMP CSRs supported by the CPU. These are only accessible from machine mode.

Name	Description	Address	Access
pmpcfg0	Physical memory protection configuration.	0x3A0	R/W
pmpcfg1	Physical memory protection configuration.	0x3A1	R/W
pmpcfg2	Physical memory protection configuration.	0x3A2	R/W
pmpcfg3	Physical memory protection configuration.	0x3A3	R/W
pmpaddr0	Physical memory protection address register.	0x3B0	R/W
pmpaddr1	Physical memory protection address register.	0x3B1	R/W
pmpaddr2	Physical memory protection address register.	0x3B2	R/W
pmpaddr3	Physical memory protection address register.	0x3B3	R/W
pmpaddr4	Physical memory protection address register.	0x3B4	R/W
pmpaddr5	Physical memory protection address register.	0x3B5	R/W
pmpaddr6	Physical memory protection address register.	0x3B6	R/W
pmpaddr7	Physical memory protection address register.	0x3B7	R/W
pmpaddr8	Physical memory protection address register.	0x3B8	R/W
pmpaddr9	Physical memory protection address register.	0x3B9	R/W
pmpaddr10	Physical memory protection address register.	0x3BA	R/W
pmpaddr11	Physical memory protection address register.	0x3BB	R/W
pmpaddr12	Physical memory protection address register.	0x3BC	R/W
pmpaddr13	Physical memory protection address register.	0x3BD	R/W
pmpaddr14	Physical memory protection address register.	0x3BE	R/W
pmpaddr15	Physical memory protection address register.	0x3BF	R/W

1.8.5 Register Description

PMP unit implements all [pmpcfg0-3](#) and [pmpaddr0-15](#) CSRs as defined in **RISC-V Instruction Set Manual Volume II: Privileged Architecture, Version 1.10**.

1.9 Physical Memory Attribute (PMA) Checker

1.9.1 Overview

CPU core also implements custom Physical Memory Attributes Checker (PMAC) to provide additional permission checks based on pre-defined memory type configured through custom CSRs.

1.9.2 Features

PMAC supports below features:

- Configurable memory type for defined memory regions
- Configurable attribute for defined memory regions

1.9.3 Functional Description

Software can program the PMAC unit's configuration and address registers in order to avoid faults due to access to invalid memory regions. PMAC CSRs can only be programmed in machine-mode. Once enabled, write, read and execute permission checks are applied to all the accesses irrespective of privilege mode as per programmed values of enabled 16 `pma_cfgX` and `pma_addrX` registers (refer to the Register summary [Register Summary](#)). Access to entries marked as invalid memory types will result in fetch fault or load/store fault exception, as the case may be.

Exception generation and handling for PMAC related faults will be handled in similar way to PMP checks. When any instruction is being fetched from a memory region configured as null or invalid memory region, an exception is generated at processor level and exception cause is set as instruction access fault in `mcause` CSR. Similarly, any load/store access to null or invalid memory region, will result in an exception generation with `mcause` updated as load access and store access fault respectively. In case of load/store access faults, violating address is captured in `mtval` CSR. For the PMAC entries configured as valid memory, the handling is same as for PMP checks.

A lock bit per entry is also provided in case software wants to disable programming of PMAC registers. Once the lock bit in any `pma_cfgX` register is set, respective `pma_cfgX` and `pma_addrX` registers can not be programmed further, unless a CPU reset cycle is applied.

A 4-bit field in PMAC CSRs is also provided to define attributes for memory regions. These bits are not used internally by CPU core for any purpose. Based on address match, these attributes are provided on load/store interface as side-band signals and are used by cache controller block for its internal operation.

1.9.4 Register Summary

Below is a list of PMA CSRs supported by the CPU. These are only accessible from machine-mode:

Name	Description	Address	Access
pma_cfg0	Physical Memory Attribute configuration	0xBC0	R/W
pma_cfg1	Physical Memory Attribute configuration	0xBC1	R/W
pma_cfg2	Physical Memory Attribute configuration	0xBC2	R/W
pma_cfg3	Physical Memory Attribute configuration	0xBC3	R/W
pma_cfg4	Physical Memory Attribute configuration	0xBC4	R/W
pma_cfg5	Physical Memory Attribute configuration	0xBC5	R/W
pma_cfg6	Physical Memory Attribute configuration	0xBC6	R/W
pma_cfg7	Physical Memory Attribute configuration	0xBC7	R/W
pma_cfg8	Physical Memory Attribute configuration	0xBC8	R/W
pma_cfg9	Physical Memory Attribute configuration	0xBC9	R/W
pma_cfg10	Physical Memory Attribute configuration	0xBCA	R/W
pma_cfg11	Physical Memory Attribute configuration	0xBCB	R/W
pma_cfg12	Physical Memory Attribute configuration	0xBCC	R/W
pma_cfg13	Physical Memory Attribute configuration	0xBCD	R/W
pma_cfg14	Physical Memory Attribute configuration	0xBCE	R/W
pma_cfg15	Physical Memory Attribute configuration	0xBCF	R/W
pma_addr0	Physical Memory Attribute address register	0xBD0	R/W
pma_addr1	Physical Memory Attribute address register	0xBD1	R/W
pma_addr2	Physical Memory Attribute address register	0xBD2	R/W
pma_addr3	Physical Memory Attribute address register	0xBD3	R/W
pma_addr4	Physical Memory Attribute address register	0xBD4	R/W
pma_addr5	Physical Memory Attribute address register	0xBD5	R/W
pma_addr6	Physical Memory Attribute address register	0xBD6	R/W
pma_addr7	Physical Memory Attribute address register	0xBD7	R/W
pma_addr8	Physical Memory Attribute address register	0xBD8	R/W
pma_addr9	Physical Memory Attribute address register	0xBD9	R/W
pma_addr10	Physical Memory Attribute address register	0xBDA	R/W
pma_addr11	Physical Memory Attribute address register	0xBDB	R/W
pma_addr12	Physical Memory Attribute address register	0xBDC	R/W
pma_addr13	Physical Memory Attribute address register	0xBDD	R/W
pma_addr14	Physical Memory Attribute address register	0xBDE	R/W
pma_addr15	Physical Memory Attribute address register	0xBDF	R/W

1.9.5 Register Description

Register 1.33. pma_cfgX (0xBC0-0xBCF)

A		LOCK		reserved		ATTRIBUTE						reserved						READ		WRITE		EXECUTE		reserved		TYPE							
31	30	29	28	27	26	25	24	23	22	21	20	19	18	17	16	15	14	13	12	11	10	9	8	7	6	5	4	3	2	1	0		
2		0		0		0						0						0		0		0		0		0		0		0		0	

Reset

A Configures address type. The functionality is the same as pmpcfg register's A field. (R/W)

0x0: OFF

0x1: TOR

0x2: NA4

0x3: NAPOT

LOCK Configures whether to lock the corresponding pma_cfgX and pma_addrX. (R/W)

0: Not locked

1: Locked. The write permission to the corresponding pma_cfgX and pma_addrX is revoked.

It can only be unlocked by core reset.

ATTRIBUTE Configures the values to be driven on DRAM attribute ports. (R/W)

READ Configures read-permission for the corresponding region.

0: Read not allowed

1: Read allowed

(R/W)

WRITE Configures write-permission for the corresponding region.

0: Write not allowed

1: Write allowed

(R/W)

EXECUTE Configures execute-permission for the corresponding region.

0: Execution not allowed

1: Execution allowed

(R/W)

TYPE Configures region type. (R/W)

0x0: Invalid memory region (RWX access will be treated as 0, even if programmed to 1)

0x1: Valid memory region (Programmed RWX access will be applicable)

Register 1.34. pma_addrX (0xBD0-0xBDF)

ADDR																															
31																															0
0																															

Reset

ADDR Configures address. The functionality is same as pmpaddr register. (R/W)

1.10 Debug

1.10.1 Overview

This section describes how to debug software running on HP and LP CPU cores. Debug support is provided through standard JTAG pins and complies to RISC-V External Debug Support Specification Version 0.13.

Figure 1-2 below shows the main components of External Debug Support.

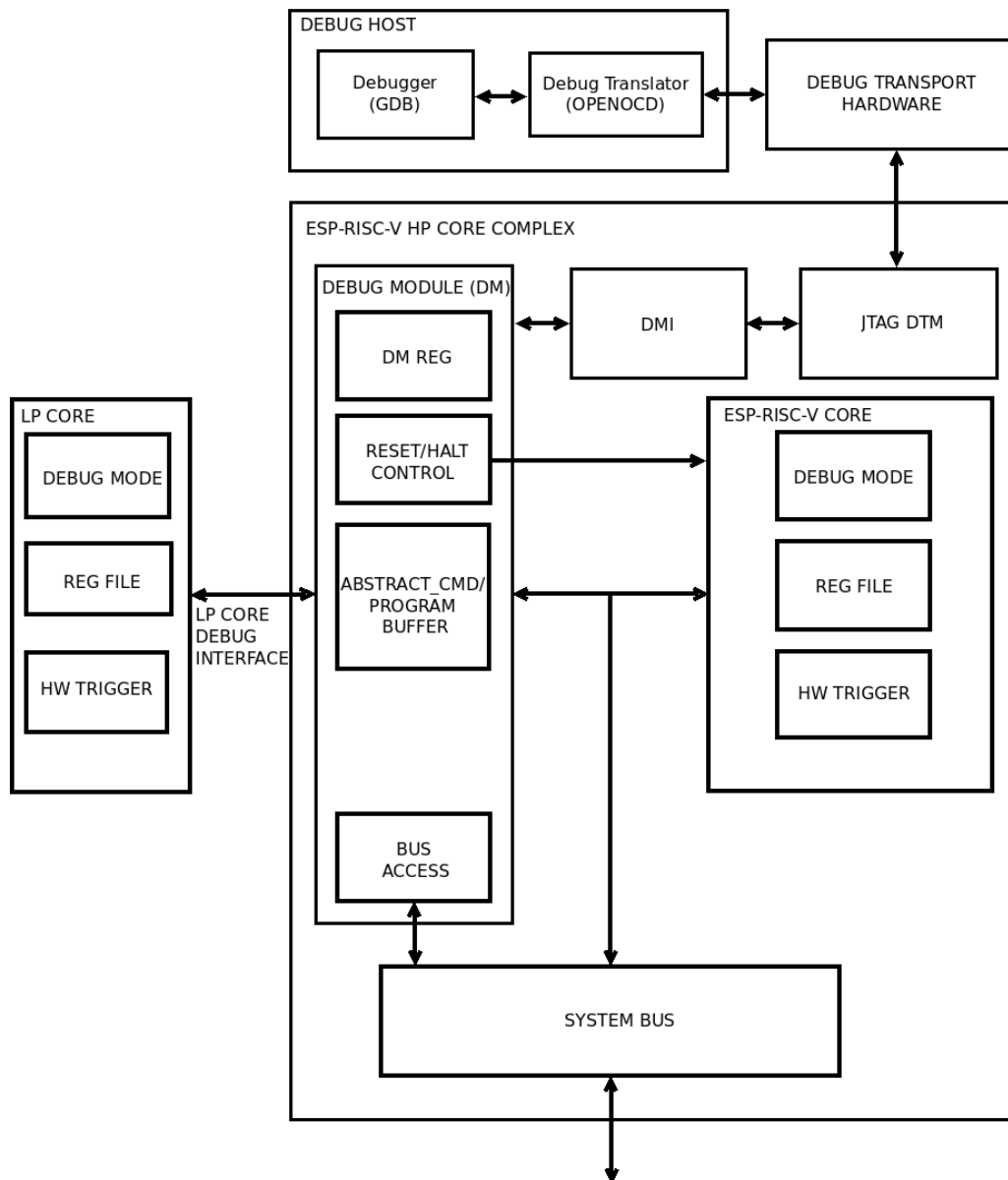

Figure 1-2. Debug System Overview

The user interacts with the Debug Host (e.g. laptop), which is running a debugger (e.g. gdb). The debugger communicates with a Debug Translator (e.g. OpenOCD, which may include a hardware driver) to communicate with Debug Transport Hardware (e.g. ESP-Prog adapter). The Debug Transport Hardware connects the Debug Host to the ESP-RISC-V Core's Debug Transport Module (DTM) through standard JTAG interface. The DTM provides access to the Debug Module (DM) using the Debug Module Interface (DMI).

The DM allows the debugger to halt selected cores. Abstract commands provide access to GPRs (general purpose registers). The Program Buffer allows the debugger to execute arbitrary code on the core, which allows

access to additional CPU core state. Alternatively, additional abstract commands can provide access to additional CPU core state. ESP-RISC-V core contains Trigger Module supporting 4 triggers. When trigger conditions are met, core will halt spontaneously and inform the debug module that they have halted.

System bus access block allows memory and peripheral register access without using the core.

1.10.2 Features

Basic debug functionality supports below features:

- Provides necessary information about the implementation to the debugger.
- Allows the CPU core to be halted and resumed.
- CPU core registers (including CSRs) can be read/written by debugger.
- CPU can be debugged from the first instruction executed after reset.
- CPU core can be reset through debugger.
- CPU can be halted on software breakpoint (planted breakpoint instruction).
- Hardware single-stepping.
- Execute arbitrary instructions in the halted CPU by means of the program buffer. 16-word program buffer is supported.
- System bus access is supported through word aligned address access.
- Supports four Hardware Triggers (can be used as breakpoints/watchpoints) as described in Section 1.11.
- Supports LP core debug.
- Supports cross-triggering between HP and LP core.

1.10.3 Functional Description

As mentioned earlier, Debug Scheme conforms to RISC-V External Debug Support Specification Version 0.13. Please refer to the specification for functional operation details.

1.10.4 JTAG Control

Standard JTAG interface is the only way for DTM to access DM. The hardware provides two JTAG methods: PAD_to_JTAG and USB_to_JTAG.

- PAD_to_JTAG : means that the JTAG's signal source comes from IO.
- USB_to_JTAG : means that the JTAG's signal source comes from USB Serial/JTAG Controller.

Which JTAG method to use depends on many factors. The following table shows the configuration method.

Temporary disable JTAG 3,4	EFUSE_DIS_USB_JTAG 4	EFUSE_DIS_USB_SERIAL_JTAG 4	EFUSE_DIS_PAD_JTAG 4	EFUSE_JTAG_SEL_ENABLE 4	Strapping Pin GPIO15 5	USB JTAG Status	PAD JTAG Status
0	0	0	0	0	x 2	Available 1	Unavailable 1

Temporary disable JTAG 3	EFUSE_DIS_USB_JTAG 4	EFUSE_DIS_USB_SERIAL_JTAG 4	EFUSE_DIS_PAD_JTAG 4	EFUSE_JTAG_SEL_ENABLE 4	Strapping Pin GPIO15 5	USB JTAG Status	PAD JTAG Status
0	0	0	0	1	1	Available	Unavailable
0	0	0	0	1	0	Unavailable	Available
0	0	1	0	x	x	Unavailable	Available
0	1	0	0	x	x	Unavailable	Available
0	1	1	0	x	x	Unavailable	Available
0	0	0	1	x	x	Available	Unavailable
0	0	1	1	x	x	Unavailable	Unavailable
0	1	0	1	x	x	Unavailable	Unavailable
0	1	1	1	x	x	Unavailable	Unavailable
1	x	x	x	x	x	Unavailable	Unavailable

Note:

1. Available: the corresponding JTAG function is available.
Unavailable: the corresponding JTAG function is not available.
2. x: do not care.
3. "Temporary disable JTAG" means that if there are an even number of bits "1" in EFUSE_SOFT_DIS_JTAG[2:0], the JTAG function is turned on (the corresponding value in the table is 1), otherwise it is turned off (the corresponding value in the table is 0). However, under certain special conditions of the HMAC Accelerator in ESP32-C6, the JTAG function may be turned on even if there is an odd number of bits "1" in EFUSE_SOFT_DIS_JTAG[2:0]. For information on how HMAC affects JTAG functionality, please refer to Chapter [HMAC Accelerator](#).
4. Please refer to Chapter [eFuse Controller](#) to get more information about eFuse.
5. Please refer to [Chip Boot Control](#) to get more information about the strapping pin GPIO15.

1.10.5 Register Summary

Below is the list of Debug CSRs supported by ESP-RISC-V CPU core:

Name	Description	Address	Access
dcsr	Debug Control and Status	0x7B0	R/W
dpc	Debug PC	0x7B1	R/W
dscratch0	Debug Scratch Register 0	0x7B2	R/W
dscratch1	Debug Scratch Register 1	0x7B3	R/W

All the debug module registers are implemented in conformance to the specification RISC-V External Debug Support Version 0.13. Please refer to it for more details.

1.10.6 Register Description

Below are the details of Debug CSRs supported by ESP-RISC-V core:

Register 1.35. dcsr (0x7B0)

xdebugver				reserved												ebreakm				reserved				ebreaku				reserved				stopcount				stoptime				cause				reserved				step		prv	
31	28	27													16	15	14	13	12	11	10	9	8					6	5					3	2	1	0														
4				0												0				0				0				0				0				0				0		0		Reset							

xdebugver Represents the debug version.

4: External debug support exists (RO)

ebreakm When 1, ebreak instructions in Machine Mode enter Debug Mode. (R/W)

ebreaku When 1, ebreak instructions in User/Application Mode enter Debug Mode. (R/W)

stopcount This feature is not implemented. Debugger will always read this bit as 0. (RO)

stoptime This feature is not implemented. Debugger will always read this bit as 0. (RO)

cause Explains why Debug Mode was entered. When there are multiple reasons to enter Debug Mode in a single cycle, the cause with the highest priority number is the one written.

- 1: An ebreak instruction was executed. (priority 3)
 - 2: The Trigger Module caused a halt. (priority 4)
 - 3: haltreq was set. (priority 2)
 - 4: The CPU core single stepped because step was set. (priority 1)
- Other values are reserved for future use.
(RO)

step When set and not in Debug Mode, the core will only execute a single instruction and then enter Debug Mode.

If the instruction does not complete due to an exception, the core will immediately enter Debug Mode before executing the trap handler, with appropriate exception registers set.
Setting this bit does not mask interrupts. This is a deviation from the RISC-V External Debug Support Specification Version 0.13.
(R/W)

prv Contains the privilege level the core was operating in when Debug Mode was entered. A debugger can change this value to change the core’s privilege level when exiting Debug Mode. Only **0x3** (machine mode) and **0x0** (user mode) are supported. (R/W)

Register 1.36. dpc (0x7B1)

dpc																																
31																														0		
0																																Reset

dpc Upon entry to debug mode, dpc is written with the virtual address of the instruction that encountered the exception. When resuming, the CPU core’s PC is updated to the virtual address stored in dpc. A debugger may write dpc to change where the CPU resumes. (R/W)

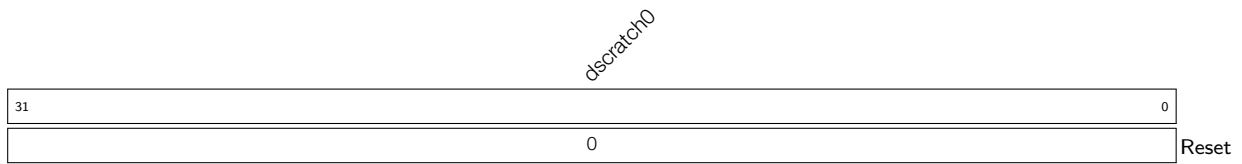
Register 1.37. dscratch0 (0x7B2)

dscratch0 Used by Debug Module internally. (R/W)

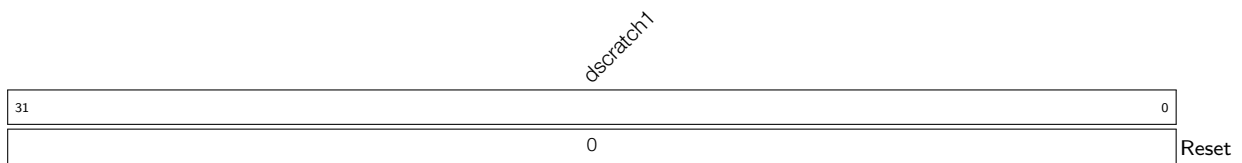
Register 1.38. dscratch1 (0x7B3)

dscratch1 Used by Debug Module internally. (R/W)

1.11 Hardware Trigger

1.11.1 Features

Hardware Trigger module provides breakpoint and watchpoint capability for debugging. It includes the following features:

- 4 independent trigger units
- each unit can be configured for matching the address of program counter or load-store accesses
- can preempt execution by causing breakpoint exception
- can halt execution and transfer control to debugger
- support NAPOT (naturally aligned power-of-two regions) address encoding

1.11.2 Functional Description

The Hardware Trigger module provides four CSRs, which are listed under Section [register summary](#). Among these, [tdata1](#) and [tdata2](#) are abstract CSRs, which means they are shadow registers for accessing internal registers for each of the four trigger units, one at a time.

To choose a particular trigger unit write the index (0-3) of that unit into [tselect](#) CSR. When [tselect](#) is written with a valid index, the abstract CSRs [tdata1](#) and [tdata2](#) are automatically mapped to reflect internal registers of that trigger unit. Each trigger unit has two internal registers, namely [mcontrol](#) and [maddress](#), which are mapped to [tdata1](#) and [tdata2](#), respectively.

Writing larger than allowed indexes to [tselect](#) will clip the written value to the largest valid index, which can be read back. This property may be used for enumerating the number of available triggers during initialization or when using a debugger.

Since software or debugger may need to know the type of the selected trigger to correctly interpret [tdata1](#) and [tdata2](#), the 4 bits (31-28) of [tdata1](#) encodes the type of the selected trigger. This type field is read-only and always provides a value of 0x2 for every trigger, which stands for match type trigger, hence, it is inferred that [tdata1](#) and [tdata2](#) are to be interpreted as [mcontrol](#) and [maddress](#). The information regarding other possible values can be found in the specification RISC-V External Debug Support Version 0.13, but this trigger module only supports type 0x2.

Once a trigger unit has been chosen by writing its index to [tselect](#), it will become possible to configure it by setting the appropriate bits in [mcontrol](#) CSR ([tdata1](#)) and writing the target address to [maddress](#) CSR ([tdata2](#)).

Each trigger unit can be configured to either cause breakpoint exception or enter debug mode, by writing to the action field of [mcontrol](#). This bit can only be written from debugger, thus by default a trigger, if enabled, will cause breakpoint exception.

[mcontrol](#) for each trigger unit has a [hit](#) bit which may be read, after CPU halts or enters exception, to find out if this was the trigger unit that fired. This bit is set as soon as the corresponding trigger fires, but it has to be manually cleared before resuming operation. Although, failing to clear it does not affect normal execution in any way.

Each trigger unit only supports match on address, although this address could either be that of a load/store access or the virtual address of an instruction. The address and size of a region are specified by writing to [maddress](#) ([tdata2](#)) CSR for the selected trigger unit. Larger than 1 byte region sizes are specified through NAPOT

(naturally aligned power-of-two) encoding (see Table 1-10) and enabled by setting match bit in mcontrol. Note that for NAPOT encoded addresses, by definition, the start address is constrained to be aligned to (i.e. an integer multiple of) the region size.

Table 1-10. NAPOT encoding for maddress

maddress(31-0)	Start Address	Size (bytes)
aaa...aaaaaaaa0	aaa...aaaaaaaa0	2
aaa...aaaaaaaa01	aaa...aaaaaaaa00	4
aaa...aaaaaaaa011	aaa...aaaaaaaa000	8
aaa...aaaaaa0111	aaa...aaaaaa0000	16
...		
a01...1111111111	a00...0000000000	2^{31}

tcontrol CSR is common to all trigger units. It is used for preventing triggers from causing repeated exceptions in machine-mode while execution is happening inside a trap handler. This also disables breakpoint exceptions inside ISRs by default, although, it is possible to manually enable this right before entering an ISR, for debugging purposes. This CSR is not relevant if a trigger is configured to enter debug mode.

1.11.3 Trigger Execution Flow

When hart is halted and enters debug mode due to the firing of a trigger (*action* = 1):

- *dpc* is set to current PC (in decode stage)
- *cause* field in *dcsr* is set to 2, which means halt due to trigger
- *hit* bit is set to 1, corresponding to the trigger(s) which fired

When hart goes into trap due to the firing of a trigger (*action* = 0) :

- *mepc* is set to current PC (in decode stage)
- *mcause* is set to 3, which means breakpoint exception
- *mpte* is set to the value in *mte* right before trap
- *mte* is set to 0
- *hit* bit is set to 1, corresponding to the trigger(s) which fired

Note: If two different triggers fire at the same time, one with action = 0 and another with action = 1, then hart is halted and enters debug mode.

1.11.4 Register Summary

Below is a list of Trigger Module CSRs supported by the CPU. These are only accessible from machine-mode.

Name	Description	Address	Access
tselect	Trigger Select Register	0x7A0	R/W
tdata1	Trigger Abstract Data 1	0x7A1	R/W
tdata2	Trigger Abstract Data 2	0x7A2	R/W
tcontrol	Global Trigger Control	0x7A5	R/W

1.11.5 Register Description

Register 1.39. tselect (0x7A0)

30	(reserved)		2	1	0	
0x00000000					0x0	Reset

tselect Configures the index (0-3) of the selected trigger unit. (R/W)

Register 1.40. tdata1 (0x7A1)

31	28	27	26	data		0	
type		dmode					
0x2		0		0x3e00000			Reset

type Represents the trigger type. This field is reserved since only match type (0x2) triggers are supported. (RO)

dmode This is set to 1 if a trigger is being used by the debugger.

0: Both Debug and M mode can write the tdata1 and tdata2 registers at the selected tselect.

1: Only Debug Mode can write the tdata1 and tdata2 registers at the selected tselect. Writes from other modes are ignored.

Note: Only writable from debug mode.

(R/W)

data Configures the abstract tdata1 content. This will always be interpreted as fields of **mcontrol** since only match type (0x2) triggers are supported. (R/W)

Register 1.41. tdata2 (0x7A2)

31	tdata2		0	
0x00000000				Reset

tdata2 Configures the abstract tdata2 content. This will always be interpreted as **maddress** since only match type (0x2) triggers are supported. (R/W)

Register 1.42. tcontrol (0x7A5)

31	(reserved)						8	7	6	(reserved)		1	0
0x000000								0	0x00		0		Reset

mpte Configures whether to enable the machine mode previous trigger.

When CPU is taking a machine mode trap, the value of **mte** is automatically pushed into this.

When CPU is executing MRET, its value is popped back into **mte**, so this becomes 0.

(R/W)

mte Configures whether to enable the machine mode trigger.

When CPU is taking a machine mode trap, its value is automatically pushed into **mpte**, so this becomes 0 and triggers with **action=0** are disabled globally.

When CPU is executing MRET, the value of **mpte** is automatically popped back into this.

(R/W)

Register 1.43. mcontrol (0x7A1)

(reserved)	dmode	(reserved)	hit	(reserved)	action	(reserved)	match	m	(reserved)	u	execute	store	load								
31	28	27	26	21	20	19	16	15	12	11	10	7	6	5	4	3	2	1	0		
0x2	0		0x1f	0	0	0	0	0	0	0	0	0	0	0	0	0	0	0	0	0	Reset

dmode Same as `dmode` in `tdata1`. (RW *)

hit This is found to be 1 if the selected trigger had fired previously. This bit is to be cleared manually. (R/W)

action Configures the selected trigger to perform one of the available actions when firing. Valid options are:

0x0: cause breakpoint exception.

0x1: enter debug mode (only valid when `dmode` = 1)

Note: Writing an invalid value will set this to the default value 0x0.

(R/W)

match Configures the selected trigger to perform one of the available matching operations on a data/instruction address. Valid options are:

0x0: exact byte match, i.e. address corresponding to one of the bytes in an access must match the value of `maddress` exactly.

0x1: NAPOT match, i.e. at least one of the bytes of an access must lie in the NAPOT region specified in `maddress`.

Note: Writing a larger value will clip it to the largest possible value 0x1.

(R/W)

m Set this for enabling selected trigger to operate in machine mode. (R/W)

u Set this for enabling selected trigger to operate in user mode. (R/W)

execute Set this for configuring the selected trigger to fire right before an instruction with matching virtual address is executed by the CPU. (R/W)

store Set this for configuring the selected trigger to fire right before a store operation with matching data address is executed by the CPU. (R/W)

load Set this for configuring the selected trigger to fire right before a load operation with matching data address is executed by the CPU. (R/W)

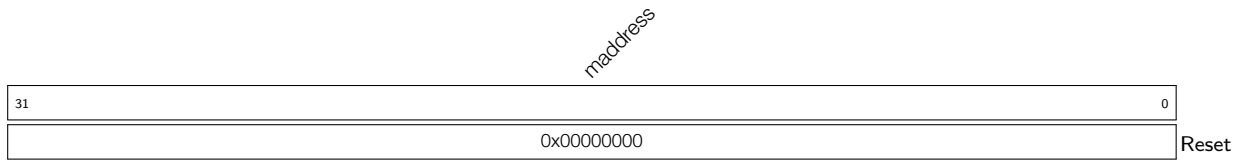
Register 1.44. maddress (0x7A2)

maddress Configures the address used by the selected trigger when performing match operation. This is decoded as NAPOT when `match=1` in `mcontrol`. (R/W)

1.12 Trace

1.12.1 Overview

In order to support non-intrusive software debug, the CPU core provides an instruction trace interface which provides relevant information for offline debug purpose. This interface provides relevant information to Trace Encoder block, which compresses the information and stores in memory allocated for it. Software decoders can read this information from trace memory without interrupting the CPU core and re-generate the actual program execution by the CPU core.

1.12.2 Features

The CPU core supports instruction trace feature and provides below information to Trace Encoder as mandated in RISC-V Processor Trace Version 1.0:

- Number of instructions being retired.
- Occurrence of exception and interrupt along with cause and trap values.
- Current privilege level of hart.
- Instruction type of retired instructions for jumps, branches and return.
- Instruction address for instructions retired before and after program counter changes.

1.12.3 Functional Description

ESP-RISC-V CPU core implements mandatory instruction delta tracing, also known as branch tracing. It works by tracking execution from a known start address by sending information about deltas taken by a program. Deltas are typically introduced by jump, call, return, branch type instructions and also by interrupts and exceptions. All such deltas along with additional details about cause and actual instructions/addresses are communicated over high bandwidth instruction trace interface output from the core. Trace Encoder operates on the information on this trace interface and compresses the information for storage in memory for offline debug by a decoder. More information about the encoding is available in Chapter 2 *RISC-V Trace Encoder (TRACE)*.

The core does not have any internal registers to provide control over instruction trace interface. All register controls are available in 2 *RISC-V Trace Encoder (TRACE)* block.

1.13 Debug Cross-Triggering

1.13.1 Overview

In a multi-core system, when the debugging software is running on a given core, it is useful that the other cores do not change the state of the system. This requirement is addressed by synchronous halt and resume. It is important that halt/resume information is communicated as quickly as possible to other cores. So, it is better to do it based on chip infrastructure rather than commands through the debugger software running on the host.

1.13.2 Features

- Control register to enable or disable cross-trigger between cores
- Overriding the RunStall functionality of a core

1.13.3 Functional Description

Such a scheme has been implemented by providing a custom control register in the debug module. The register [CORE_XT_EN](#) implements a control bit to enable or disable cross-triggering mode. Once enabled, any core halted due to events such as hardware trigger and ebreak instructions will also result in halting of other cores without any intervention from the debugger. After halting of cores due to cross-trigger mode, it is not possible to resume without debugger intervention. The debugger has to connect to all cores and resume each core synchronously. Please note, debug cross trigger also halts any core which is stalled due to RunStall functionality.

1.13.4 Register Summary

Below is a required control register implemented inside debug module.

Name	Description	Address	Access
CORE_XT_EN	Cross Triggering Control.	0x20000900	R/W

1.13.5 Register Description

Register 1.45. CORE_XT_EN (0x20000900)

(reserved)	xt_en
31	1 0
0	0 Reset

XT_EN Configures whether to enable the cross-trigger mode.

0: Disable

1: Enable

(R/W)

1.14 Dedicated IO

1.14.1 Overview

Normally, GPIOs are an APB peripheral, which means that changes to outputs and reads from inputs can get stuck in write buffers or behind other transfers, and in general are slower because generally the APB bus runs at a lower speed than the CPU. As an alternative, the CPU core implements I/O processors specific CPU registers (CSRs) which are directly connected to the GPIO matrix or IO pads. As these registers can get accessed in one instruction, speed is fast.

1.14.2 Features

- 8 dedicated IOs directly mapped on GPIOs
- No latency for driving output ports
- Two CPU cycle latency for sensing input values

1.14.3 Functional Description

The CPU core has a set of 8 inputs and outputs (pin value + pin output enable). These input and output ports are directly connected to the GPIO matrix, through which they can be mapped on top-level pads. Please refer to [Chapter 7 IO MUX and GPIO Matrix \(GPIO, IO MUX\)](#) for more details.

The CPU implements three custom CSRs:

- GPIO_IN is read-only and reflects the input value.
- GPIO_OUT is R/W and reflects the output value for the GPIOs.
- GPIO_OEN is R/W and reflects the output enable state for the GPIOs. It controls the pad direction. Programming high would mean the pad should be configured in output mode. Programming low means it should be configured in input mode.

1.14.4 Register Summary

Below is a list of custom dedicated IO CSRs implemented inside the core.

Name	Description	Address	Access
cpu_gpio_oen	GPIO Output Enable	0x803	R/W
cpu_gpio_in	GPIO Input Value	0x804	RO
cpu_gpio_out	GPIO Output Value	0x805	R/W

1.14.5 Register Description

Register 1.46. [cpu_gpio_oen](#) (0x803)

(reserved)								CPU_GPIO_OEN[7] CPU_GPIO_OEN[6] CPU_GPIO_OEN[5] CPU_GPIO_OEN[4] CPU_GPIO_OEN[3] CPU_GPIO_OEN[2] CPU_GPIO_OEN[1] CPU_GPIO_OEN[0]									
31								8	7	6	5	4	3	2	1	0	
0								0	0	0	0	0	0	0	0	0	0

Reset

CPU_GPIO_OEN Configures whether to enable GPIO_n (n=0 ~ 21) output. CPU_GPIO_OEN[7:0] correspond to output enable signals [cpu_gpio_out_oen\[7:0\]](#) in Table 7-2 *Peripheral Signals via GPIO Matrix*. CPU_GPIO_OEN value matches that of [cpu_gpio_out_oen](#). CPU_GPIO_OEN is the enable signal of [CPU_GPIO_OUT](#).

0: Disable GPIO output

1: Enable GPIO output

(R/W)

Register 1.47. [cpu_gpio_in](#) (0x804)

(reserved)								CPU_GPIO_IN[7] CPU_GPIO_IN[6] CPU_GPIO_IN[5] CPU_GPIO_IN[4] CPU_GPIO_IN[3] CPU_GPIO_IN[2] CPU_GPIO_IN[1] CPU_GPIO_IN[0]								
31								8	7	6	5	4	3	2	1	0
0								0	0	0	0	0	0	0	0	0

Reset

CPU_GPIO_IN Represents GPIO_n (n=0 ~ 21) input value. It is a CPU CSR to read input value (1=high, 0=low) from SoC GPIO pin.

CPU_GPIO_IN[7:0] correspond to input signals [cpu_gpio_in\[7:0\]](#) in Table 7-2 *Peripheral Signals via GPIO Matrix*.

CPU_GPIO_IN[7:0] can only be mapped to GPIO pins through GPIO matrix. For details please refer to Section 7.4 in Chapter *IO MUX and GPIO Matrix (GPIO, IO MUX)*.

(RO)

Register 1.48. cpu_gpio_out (0x805)

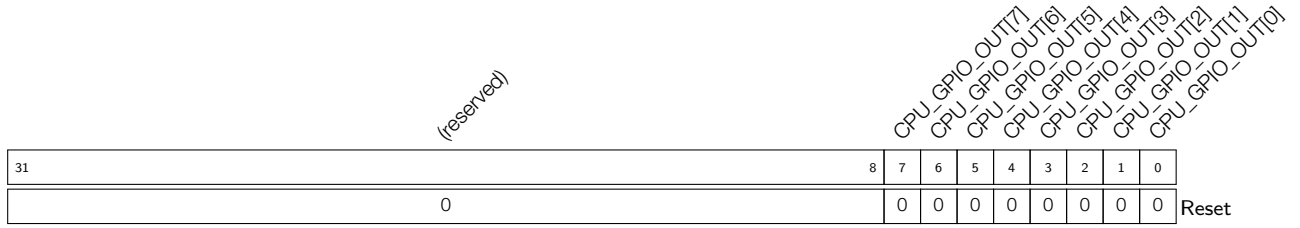

CPU_GPIO_OUT Configures GPIO n (n=0 ~ 21) output value. It is a CPU CSR to write value (1=high, 0=low) to SoC GPIO pin. The value takes effect only when **CPU_GPIO_OEN** is set.

CPU_GPIO_OUT[7:0] correspond to output signals cpu_gpio_out[7:0] in Table 7-2 Peripheral Signals via GPIO Matrix.

CPU_GPIO_OUT[7:0] can only be mapped to GPIO pins through GPIO matrix. For details please refer to Section 7.5 in Chapter IO MUX and GPIO Matrix (GPIO, IO MUX).

(R/W)

1.15 Atomic (A) Extension

1.15.1 Overview

Support for atomic (A) extension is available in compliance with the RISC-V ISA Manual Volume I: Unprivileged ISA Version 2.2, with an emphasis to guarantee forward progress, i.e. any situation that may cause data memory lock for an indefinite amount of time is prevented by their very functionality.

The atomic instructions currently ignore the `aq` (acquire) and `rl` (release) bits as they are irrelevant to the current architecture in which memory ordering is always guaranteed.

1.15.2 Functional Description

1.15.2.1 Load Reserve (LR.W) Instruction

The LR.W instruction simply locks a 32-bit aligned memory address to which the load access is being performed. Once a 4-byte memory region is locked, it will remain locked, i.e. other harts won't be able to access this same memory location, until any of the following scenarios is encountered during execution:

- any load operation
- any store operation
- any interrupts/exceptions
- backward jump/taken backward branch
- JALR
- ECALL/EBREAK/MRET/URET
- FENCE/FENCE.I
- debug mode
- critical section exceeding 64 bytes
- data address in SC.W instruction not matching that in LR.W instruction

If any of the above happens, except SC.W, the memory lock will be released immediately. If an SC instruction is encountered instead, the lock will be released eventually (not immediately) in the manner described in Section 1.15.2.2.

If a misaligned address is encountered, it will cause an exception with `mcause` = 6.

1.15.2.2 Store Conditional (SC.W) Instruction

The SC.W instruction first checks if the memory lock is still valid, and the address is the same as specified during the last LR.W instruction. If so, only then will it perform the store to memory, and later release the lock as soon as it gets an acknowledgement of operation completion from the memory.

On the other hand, if the lock is found to have been invalidated (due to any of the situations as described in Section 1.15.2.1), it will set a fail code (currently always 1) in the destination register `rd`.

If a misaligned address is encountered, it will cause an exception with `mcause` = 6.

1.15.2.3 AMO Instructions

An AMO instruction executes in 3 steps:

1. Read data from memory address given by rs1, and save it to destination register rd.
2. Combine the data in rd and rs2 according to the operation type and keep the result for Step 3 below.
3. Write the result obtained in Step 2 above to memory address given by rs1.

There are 9 different AMO operations: SWAP, ADD, AND, OR, XOR, MAX, MIN, MAXU and MINU.

During this whole process, the memory address is kept locked from being accessed by other harts. If a misaligned address is encountered, it will cause an exception with `mcause` = 6.

For AMO operations both load and store access faults (PMP/PMA) are checked in the 1st step itself. For such cases `mcause` = 7.

2 RISC-V Trace Encoder (TRACE)

The high-performance CPU (HP CPU) of ESP32-C6 supports instruction trace interface through the trace encoder. The trace encoder connects to HP CPU's instruction trace interface, compresses the information into smaller packets, and then stores the packets in internal SRAM (see Chapter 5 *System and Memory*).

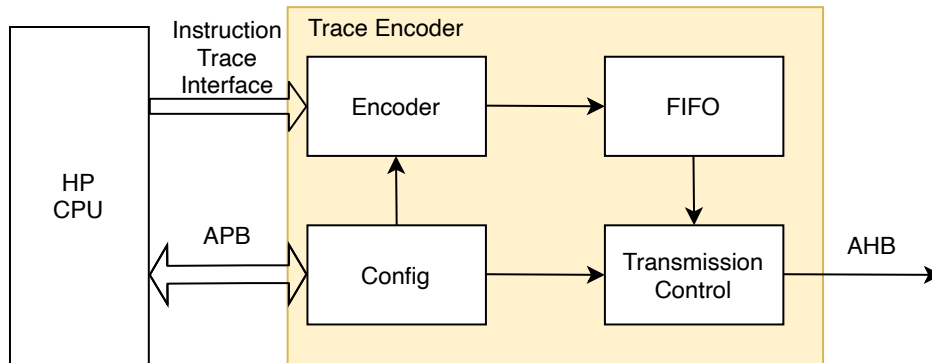

Figure 2-1. Trace Encoder Overview

2.1 Terminology

To better illustrate the functions of the RISC-V Trace Encoder, the following terms are used in this chapter.

hart	RISC-V hardware thread
branch	an instruction which conditionally changes the execution flow
uninferable discontinuity	a program counter change that can not be inferred from the program binary alone
delta	a change in the program counter that is other than the difference between two instructions placed consecutively in memory
trap	the transfer of control to a trap handler caused by either an exception or an interrupt
qualification	an instruction that meets the filtering criteria passes the qualification, and will be traced
te_inst	the name of the packet type emitted by the encoder
retire	the final stage of executing an instruction, when the machine state is updated

2.2 Introduction

In complex systems, understanding program execution flow is not straightforward. This may be due to a number of factors, for example, interactions with other cores, peripherals, real-time events, poor implementations, or some combination of all of the above.

It is hard to use a debugger to monitor the program execution flow of a running system in real time, as this is intrusive and might affect the running state. But providing visibility of program execution is important.

That is where instruction trace comes in, which provides trace of the program execution.

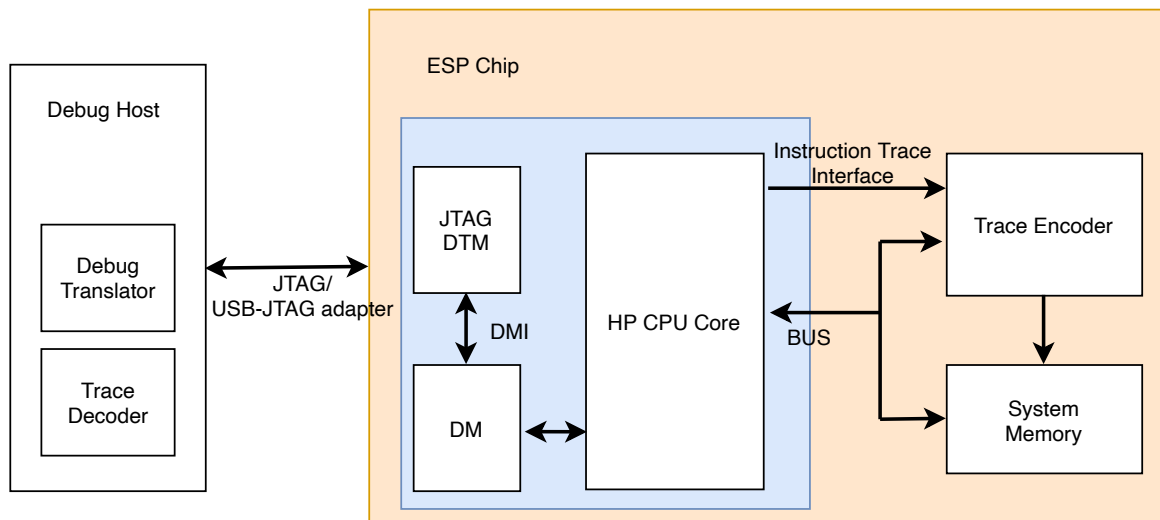

Figure 2-2. Trace Overview

Figure 2-2 shows the schematics of instruction trace:

- The HP CPU core provides an instruction trace interface that outputs the instruction information executed by the HP CPU. Such information includes instruction address, instruction type, etc. For more details about ESP32-C6 HP CPU's instruction trace interface, please refer to Chapter 1 *High-Performance CPU*.
- The trace encoder connects to the HP CPU's instruction trace interface and compresses the information into lower bandwidth packets, and then stores the packets in system memory.
- The debugger can dump the trace packets from the system memory via JTAG or USB Serial/JTAG, and use a decoder to decompress and reconstruct the program execution flow. The Trace Decoder, usually software on an external PC, takes in the trace packets and reconstructs the program instruction flow with the program binary that runs on the originating hart. This decoding step can be done offline or in real-time while the hart is executing.

This chapter mainly introduces the implementation details of ESP32-C6's trace encoder.

2.3 Features

- Compatible with RISC-V Processor Trace Version 1.0. See Table 2-2 for the implemented parameters
- Arbitrary address range of the trace memory size
- Two synchronization modes:
 - synchronization counter counts by packet
 - synchronization counter counts by cycle
- Trace lost status to indicate packet loss
- Automatic restart after packet loss
- Memory writing in loop or non-loop mode
- Two interrupts:

- Triggered when the packet size exceeds the configured memory space
- Triggered when a packet is lost
- FIFO (128 × 8 bits) to buffer packets

Table 2-2. Trace Encoder Parameters

Parameter Name	Value	Description
arch_p	0	Initial version
bpred_size_p	0	Branch prediction mode is not supported
cache_size_p	0	Jump target cache mode is not supported
call_counter_size_p	0	Implicit return mode is not supported
ctype_width_p	0	Packets contain no context information
context_width_p	0	Packets contain no context information
ecause_width_p	5	Width of exception cause
ecause_choice_p	0	Multiple choice is not supported
f0s_width_p	0	Format 0 packets are not supported
filter_context_p	0	Filter function is not supported
filter_excint_p	0	
filter_privilege_p	0	
filter_tval_p	0	
iaddress_lsb_p	1	Compressed instructions are supported
iaddress_width_p	32	The instruction bus is 32-bit
iretire_width_p	1	Width of the iretire bus
ilastsize_width_p	0	Width of the ilastsize
itype_width_p	3	Width of the itype bus
noncontext_p	1	Exclude context from te_inst packets
privilege_width_p	1	Only machine and user mode are supported
retires_p	1	Maximum number of instructions that can be retired per block
return_stack_size_p	0	Implicit return mode is not supported
sijump_p	0	Sequentially inferable jump mode is not supported
taken_branches_p	1	Only one instruction retired per cycle
impdef_width_p	0	Not implemented

For detailed descriptions of the above parameters, please refer to the RISC-V Processor Trace Version 1.0 > Chapter Parameters and Discovery.

2.4 Architectural Overview

As shown in Figure 2-1, the trace encoder contains an encoder, a FIFO, a register configuration module, and a transmission control module.

The encoder receives HP CPU's instruction information via the instruction trace interface, compresses it into different packets, and writes it to the internal FIFO.

The transmission control module writes the data in the FIFO to the internal SRAM through the AHB bus.

The FIFO is 128 deep and 8-bit wide. When the memory bandwidth is insufficient, the FIFO may overflow and

packet loss occurs. If a packet is lost, the encoder will send a packet to tell that a packet is lost, and will stop working until the FIFO is empty.

2.5 Functional Description

2.5.1 Synchronization

In order to make the trace robust there must be regular synchronization points within the trace. Synchronization is accomplished by sending a full valued instruction address. When the synchronization counter value reaches the value of the `TRACE_RESYNC_MODE` bit of the `TRACE_RESYNC_PROLONGED_REG` register, the encoder will send a synchronization packet (format 3 subformat 0, see Section 2.6.3.1).

There are two synchronization modes configured via `TRACE_RESYNC_MODE`:

- 0: Synchronization counter counts by cycle
- 1: Synchronization counter counts by packet

You can adjust the trace bandwidth by increasing the value of `TRACE_RESYNC_PROLONGED_REG` to reduce the frequency of sending synchronization packets, thereby reducing the bandwidth occupied by packets.

2.5.2 Anchor Tag

Since the length of data packets is variable, in order to identify boundaries between data packets when packed packets are written to memory, ESP32-C6 inserts zero bytes between data packets:

- The maximum packet length is 13 bytes, so a sequence of at least 14 zero bytes cannot occur within a packet. Therefore, the first non-zero byte seen after a sequence of at least 14 zero bytes must be the first byte of a packet.
- Every time when 128 packets are transmitted, the encoder writes 14 zero bytes to the memory partition boundary as anchor tags.

2.5.3 Memory Writing Mode

When writing the trace memory, the size of the trace packets might exceed the capacity of the memory. In this case, you can choose whether to wrap around the trace memory or not by configuring the memory writing mode:

- Loop mode: When the size of the trace packets exceeds the capacity of the trace memory (namely when `TRACE_MEM_CURRENT_ADDR_REG` reaches the value of `TRACE_MEM_END_ADDR_REG`), the trace memory is wrapped around, so that the encoder loops back to the memory's starting address `TRACE_MEM_START_ADDR_REG`, and old data in the memory will be overwritten by new data.
- Non-loop mode: When the size of the trace packets exceeds the capacity of the trace memory, the trace memory is not wrapped around. The encoder stops at `TRACE_MEM_END_ADDR_REG`, and old data will be retained.

2.5.4 Automatic Restart

When packets are lost due to FIFO overflow, the encoder will stop working and need to be resumed by software. If the `TRACE_RESTART_ENA` bit of `TRACE_TRIGGER_REG` is set, once the FIFO is empty, the encoder can automatically be restarted and does not need to be resumed by software.

If the automatic restart feature is enabled, the encoder will be restarted in any case. Therefore, to disable the encoder, the automatic restart feature must be disabled first by clearing the `TRACE_RESTART_ENA` bit of the `TRACE_TRIGGER_REG` register.

2.6 Encoder Output Packets

This section mainly introduces ESP32-C6 trace encoder output packet format. ESP32-C6 only implements mandatory instruction delta tracing. It does not support the following optional features:

- Delta address mode (run-time configurable modes is supported)
- Context information and all context-related fields
- Optional sideband signals
- Trigger outputs from the Debug Module

For details about the above features, please refer RISC-V Processor Trace Version 1.0 (referred to below as the specification).

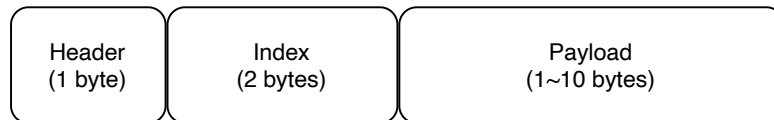

Figure 2-3. Trace packet Format

A packet includes header, index and payload. Header, index and payload are transmitted sequentially in bit stream form, from the fields listed at the top of tables below to the fields listed at the bottom. If a field consists of multiple bits, then the least significant bit is transmitted first.

2.6.1 Header

Header is 1-byte long. The format of header is shown in Table 2-3.

Table 2-3. Header Format

Field	Bits	Description	Value
length	5	Length of whole packet	4~13
placeholder	3	Reserved	0

2.6.2 Index

Index has 2 bytes. The format of index is shown in Table 2-4.

Table 2-4. Index Format

Field	Bits	Description	Value
index	16	The index of each packet	0~65536

2.6.3 Payload

The length of payload ranges from 1 byte to 10 bytes.

2.6.3.1 Format 3 Packets

Format 3 packets are used for synchronization, and report supporting information. There are 4 subformats defined in the specification. ESP32-C6 only supports 3 of them.

Format 3 Subformat 0 - Synchronization

This packet contains all the information the decoder needs to fully identify an instruction. It is sent for the first traced instruction (unless that instruction also happens to be a first in an exception handler), and when synchronization has been scheduled by expiry of the synchronization timer. The payload length is 5 bytes.

Table 2-5. Packet format 3 subformat 0

Field name	Bits	Description
format	2	11 (sync): Synchronization
subformat	2	00 (start): Start of tracing, or resync
branch	1	Set to 0 if the address points to a branch instruction, and the branch was taken. Set to 1 if the instruction is not a branch or if the branch is not taken.
privilege	1	The privilege level of the reported instruction
address	31	Full instruction address. The address must be left shifted 1 bit in order to recreate the original byte address.
sign_extend	3	Reserved

Format 3 Subformat 1 - Exception

This packet also contains all the information the decoder needs to fully identify an instruction. It is sent following an exception or interrupt, and includes the cause, the 'trap value' (for exceptions), and the address of the trap handler or of the exception itself. The length is 10 bytes.

Table 2-6. Packet format 3 subformat 1

Field name	Bits	Description
format	2	11 (sync): Synchronization
subformat	2	01 (exception): Exception cause and trap handler address
branch	1	Set to 0 if the address points to a branch instruction, and the branch was taken. Set to 1 if the instruction is not a branch or if the branch is not taken.
privilege	1	The privilege level of the reported instruction
ecause	5	Exception cause
interrupt	1	Interrupt
address	31	Full instruction address. The value of this field must be left shifted 1 bit in order to recreate original byte address.

Field name	Bits	Description
tvalepc	32	Exception address if ecause is 2 and interrupt is 0, or trap value otherwise
sign_extend	6	Reserved

Format 3 Subformat 3 - Support

This packet provides supporting information to aid the decoder. It is issued when the trace is ended. The length is 1 byte.

Table 2-7. Packet format 3 subformat 3

Field name	Bits	Description
format	2	11 (sync): Synchronization
subformat	2	11 (support): Supporting information for the decoder
enable	1	Indicates if the encoder is enabled
qual_status	2	Indicates qualification status: <ul style="list-style-type: none"> • 00 (no_change): No change to filter qualification • 01 (ended_rep): Qualification ended, preceding instruction sent explicitly to indicate last qualification instruction • 10 (trace lost): One or more packets lost • 11 (ended_upd): Qualification ended, preceding te_inst would have been sent anyway due to an updiscon, even if wasn't the last qualified instruction
sign_extend	1	Reserved

2.6.3.2 Format 2 Packets

This packet contains only an instruction address, and is used when the address of an instruction must be reported, and there is no reported branch information. The length is 5 bytes.

Table 2-8. Packet format 2

Field name	Bits	Description
format	2	10 (addr-only): No branch information
address	31	Full instruction address
notify	1	ESP32-C6 don't support notification, so this bit is always same with the MSB of address.
updiscon	1	If the value of this bit is different from notify, it indicates that this packet is reporting the instruction following an uninferable discontinuity and is also the instruction before an exception, privilege change or resync.
sign_extend	5	

2.6.3.3 Format 1 Packets

This packet includes branch information, and is used when either the branch information must be reported (for example because the branch map is full), or when the address of instruction must be reported, and there has must been at least one branch since the previous packet. This packet only supports full address mode.

Format 1 - address, branch_map

The length is variable.

Table 2-9. Packet format 1 with address

Field name	Bits	Description
format	2	01: Includes branch information
branches	5	Number of valid bits branch_map. The number of bits of branch_map is determined as follows: <ul style="list-style-type: none"> • 0: (cannot occur for this format) • 1: 1 bit • 2-3: 3 bits • 4-7: 7 bits • 8-15: 15 bits • 16-31: 31 bits For example if branches = 12, branch_map is 15-bit long, and the 12 LSBs are valid.
branch_map	Variable	An array of bits indicating whether branches are taken or not. Bit 0 represents the oldest branch instruction executed. For each bit: <ul style="list-style-type: none"> • 0: branch taken • 1: branch not taken The field Bits is variable and determined by the branches field.
address	31	Full instruction address
notify	1	ESP32-C6 don't support notification, so this bit is always same with the MSB of address.
updiscon	1	If the value of this bit is different from notify, it indicates that this packet is reporting the instruction following an uninferable discontinuity and is also the instruction before an exception, privilege change or resync.
sign_extend	Variable	The field bits are determined by the branches. The number of bits of sign_extend is as follows: <ul style="list-style-type: none"> • 1: 7 bits • 2-3: 5 bits • 4-7: 1 bit • 8-15: 1 bit • 16-32: 31 bits

Format 1 - no address, branch_map

The length is 5 bytes.

Table 2-10. Packet format 1 without address

Field name	Bits	Description
format	2	01: includes branch information
branches	5	Number of valid bits in branch_map. The length of branch_map is 31 bits. Only 0 valid.
branch_map	31	An array of bits indicating whether branches are taken or not. Bit 0 represents the oldest branch instruction executed. For each bit: <ul style="list-style-type: none"> • 0: branch taken • 1: branch not taken
sign_extend	2	Reserved

2.7 Interrupt

- TRACE_MEM_FULL_INTR: Triggered when the packet size exceeds the capacity of the trace memory, namely when [TRACE_MEM_CURRENT_ADDR_REG](#) reaches the value of [TRACE_MEM_END_ADDR_REG](#). If necessary, this interrupt can be enabled to notify the HP CPU for processing, such as applying for a new memory space again.
- TRACE_FIFO_OVERFLOW_INTR: Triggered when the internal FIFO overflows and one or more packets have been lost.

After enabling the trace encoder interrupts, map them to numbered CPU interrupts through the Interrupt Matrix, so that the HP CPU can respond to these trace encoder interrupts. For details, please refer to Chapter 10 [Interrupt Matrix \(INTMTX\)](#).

2.8 Programming Procedures

2.8.1 Enable Encoder

- Configure the address space for the trace memory via [TRACE_MEM_START_ADDR_REG](#) and [TRACE_MEM_END_ADDR_REG](#)
- Update the value of [TRACE_MEM_CURRENT_ADDR_REG](#) to the value of [TRACE_MEM_START_ADDR_REG](#) by setting [TRACE_MEM_CURRENT_ADDR_UPDATE](#)
- (Optional) Configure the memory writing mode via the [TRACE_MEM_LOOP](#) bit of [TRACE_TRIGGER_REG](#)
 - 0: Non-loop mode
 - 1: Loop mode (default)
- Configure the synchronization mode via the [TRACE_RESYNC_MODE](#) bit of [TRACE_RESYNC_PROLONGED_REG](#)
 - 0: count by cycle (default)
 - 1: count by packet
- (Optional) Configures the threshold for the synchronization counter (default value is 128) via [TRACE_RESYNC_PROLONGED_REG](#)
- (Optional) Enable Interrupt

- Set the corresponding bit of [TRACE_INTR_ENA_REG](#) to enable the corresponding interrupt
- Set the corresponding bit of [TRACE_INTR_CLR_REG](#) to clear the corresponding interrupt
- Read [TRACE_INTR_RAW_REG](#) to know which interrupt occurs
- (Optional) Enable automatic restart by setting the [TRACE_RESTART_ENA](#) bit of [TRACE_TRIGGER_REG](#). This function is enabled by default
- Enable the trace encoder by setting the [TRACE_TRIGGER_ON](#) field of [TRACE_TRIGGER_REG](#)

Once the encoder is enabled, it will keep tracing the HP CPU's instruction trace interface and writing packets to the trace memory.

2.8.2 Disable Encoder

- Disable automatic restart by clearing the [TRACE_RESTART_ENA](#) bit of [TRACE_TRIGGER_REG](#)
- Stop the encoder by setting the [TRACE_TRIGGER_OFF](#) bit of [TRACE_TRIGGER_REG](#)
- Confirm whether all data in the FIFO have been written into the memory by reading the [TRACE_FIFO_EMPTY](#) bit

2.8.3 Decode Data Packets

- Find the first address to decode
 - Read the [TRACE_MEM_FULL_INTR_RAW](#) bit of the [TRACE_INTR_RAW_REG](#) register to know if the trace memory is full
 - * if read 1, read the trace packets from [TRACE_MEM_START_ADDR_REG](#)
 - * if read 0, and the loop mode is enabled, then the old trace packets are overwritten. In this case, read the [TRACE_MEM_CURRENT_ADDR_REG](#) to know the last writing address, and use this address as the first address to decode
- Use the decoder to decode data packets
 - The decoder reads all data packets starting from the first address, and reconstructs the data stream with the binary file
 - As mentioned in [2.6](#), the encoder writes 14 zero bytes to the memory partition boundary every time when 128 packets are transmitted. Given this fact, the first non-zero byte after 14 zero bytes should be the header of a new packet

2.9 Register Summary

The addresses in this section are relative to RISC-V Trace Encoder base address provided in Table 5-2 in Chapter 5 *System and Memory*.

The abbreviations given in Column **Access** are explained in Section *Access Types for Registers*.

Name	Description	Address	Access
Memory configuration registers			
TRACE_MEM_START_ADDR_REG	Memory start address	0x0000	R/W
TRACE_MEM_END_ADDR_REG	Memory end address	0x0004	R/W
TRACE_MEM_CURRENT_ADDR_REG	Memory current address	0x0008	RO
TRACE_MEM_ADDR_UPDATE_REG	Memory address update	0x000C	WT
FIFO status register			
TRACE_FIFO_STATUS_REG	FIFO status register	0x0010	RO
Interrupt registers			
TRACE_INTR_ENA_REG	Interrupt enable register	0x0014	R/W
TRACE_INTR_RAW_REG	Interrupt raw status register	0x0018	RO
TRACE_INTR_CLR_REG	Interrupt clear register	0x001C	WT
Trace configuration registers			
TRACE_TRIGGER_REG	Trace enable register	0x0020	varies
TRACE_RESYNC_PROLONGED_REG	Resynchronization configuration register	0x0024	R/W
Clock gating control and configuration register			
TRACE_CLOCK_GATE_REG	Clock gating control register	0x0028	R/W
Version register			
TRACE_DATE_REG	Version control register	0x03FC	R/W

2.10 Registers

The addresses in this section are relative to RISC-V Trace Encoder base address provided in Table 5-2 in Chapter 5 *System and Memory*.

Register 2.1. TRACE_MEM_START_ADDR_REG (0x0000)

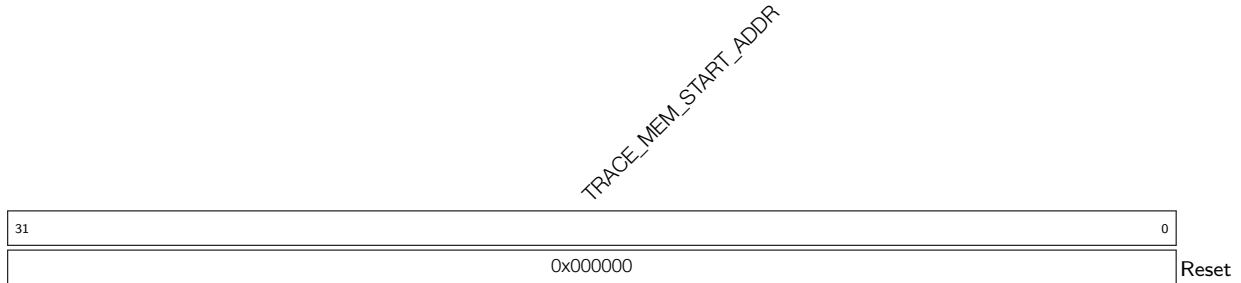

TRACE_MEM_START_ADDR Configures the start address of trace memory. (R/W)

Register 2.2. TRACE_MEM_END_ADDR_REG (0x0004)

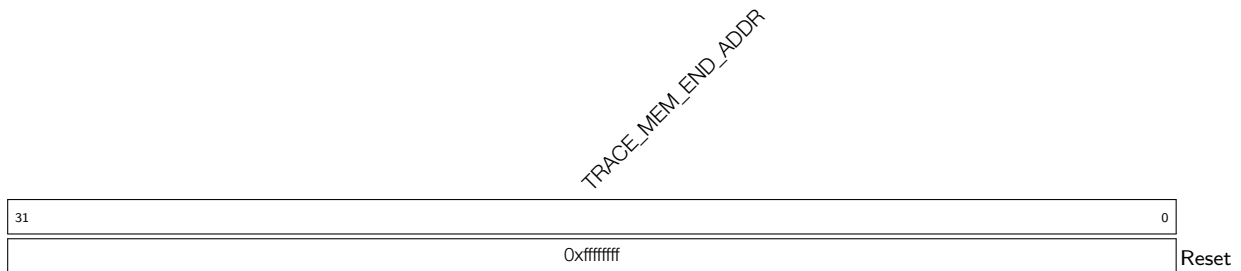

TRACE_MEM_END_ADDR Configures the end address of trace memory. (R/W)

Register 2.3. TRACE_MEM_CURRENT_ADDR_REG (0x0008)

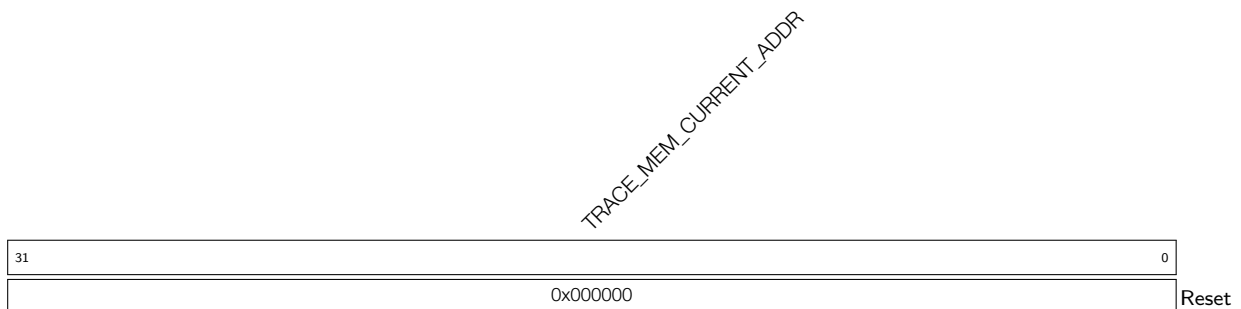

TRACE_MEM_CURRENT_ADDR Represents the current memory address for writing. (RO)

Register 2.4. TRACE_MEM_ADDR_UPDATE_REG (0x000C)

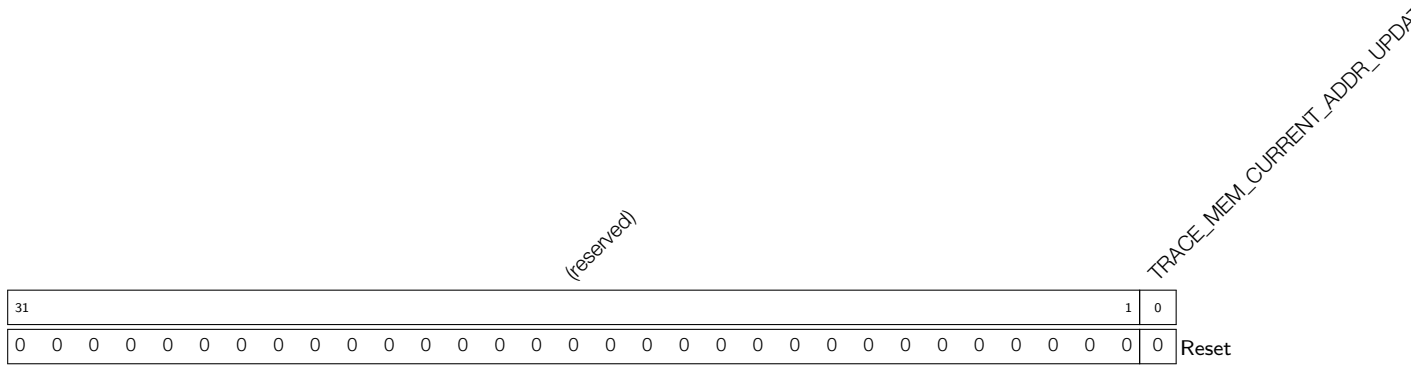

TRACE_MEM_CURRENT_ADDR_UPDATE Configures whether to update the current memory address to the start address of the memory.

- 0: Not update
 - 1: Update
- (WT)

Register 2.5. TRACE_FIFO_STATUS_REG (0x0010)

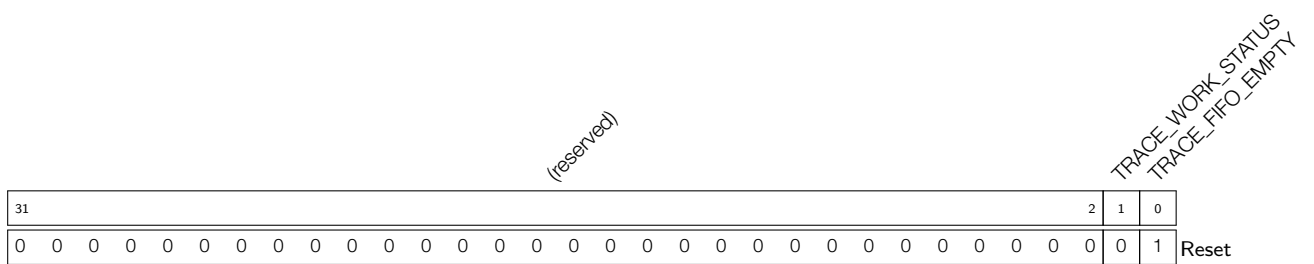

TRACE_FIFO_EMPTY Represents the FIFO status.

- 0: Not empty
 - 1: Empty
- (RO)

TRACE_WORK_STATUS Represents the encoder status.

- 0: Not tracing instruction.
 - 1: Tracing instructions and reporting packets.
- (RO)

Register 2.6. TRACE_INTR_ENA_REG (0x0014)

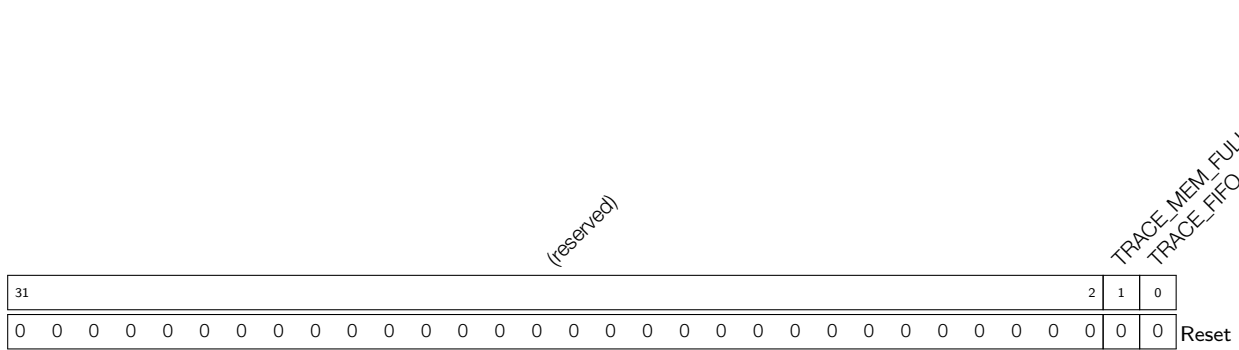

TRACE_FIFO_OVERFLOW_INTR_ENA Write 1 to enable TRACE_FIFO_OVERFLOW_INTR. (R/W)

TRACE_MEM_FULL_INTR_ENA Write 1 to enable TRACE_MEM_FULL_INTR. (R/W)

Register 2.7. TRACE_INTR_RAW_REG (0x0018)

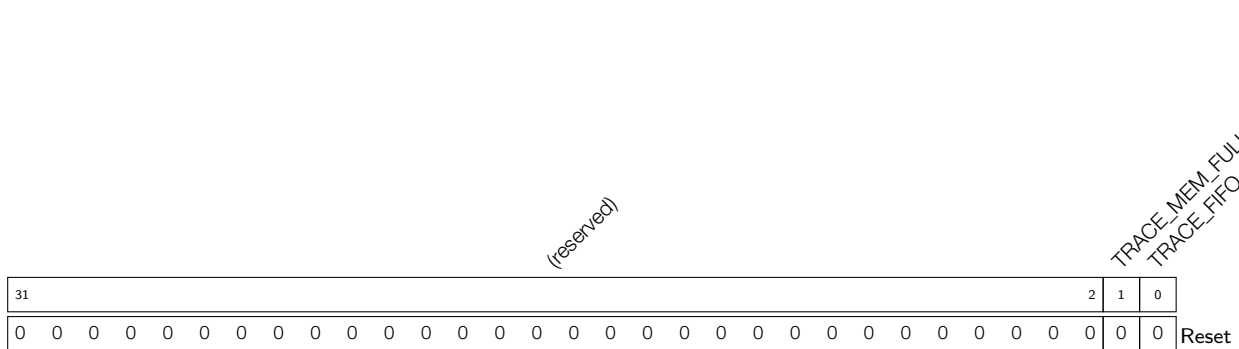

TRACE_FIFO_OVERFLOW_INTR_RAW The raw interrupt status of TRACE_FIFO_OVERFLOW_INTR. (RO)

TRACE_MEM_FULL_INTR_RAW The raw interrupt status of TRACE_MEM_FULL_INTR. (RO)

Register 2.8. TRACE_INTR_CLR_REG (0x001C)

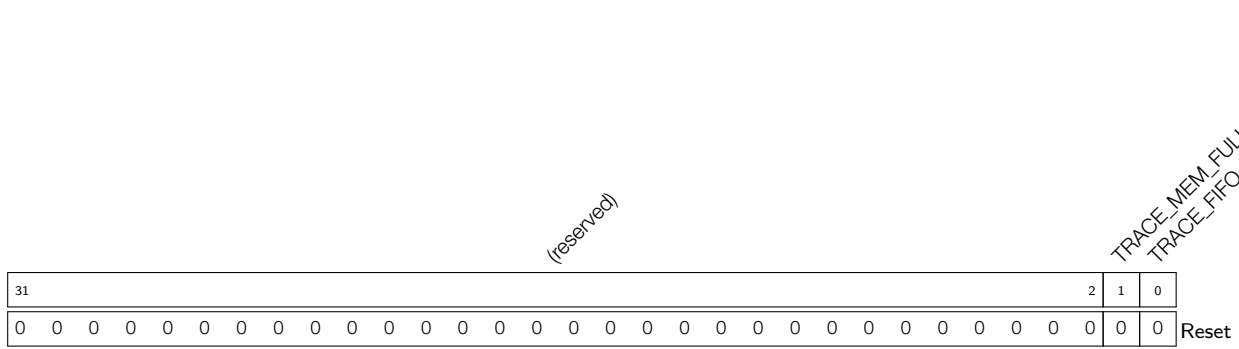

TRACE_FIFO_OVERFLOW_INTR_CLR Write 1 to clear TRACE_FIFO_OVERFLOW_INTR. (WT)

TRACE_MEM_FULL_INTR_CLR Write 1 to clear TRACE_MEM_FULL_INTR. (WT)

Register 2.9. TRACE_TRIGGER_REG (0x0020)

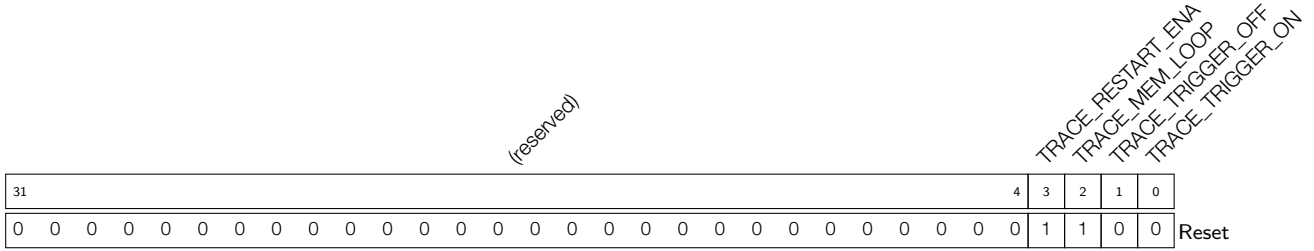

TRACE_TRIGGER_ON Configures whether or not to enable the trace encoder.

- 0: Invalid. No effect
 - 1: Enable
- (WT)

TRACE_TRIGGER_OFF Configures whether to stop the trace encoder.

- 0: Invalid. No effect
 - 1: Stop
- (WT)

TRACE_MEM_LOOP Configures memory mode.

- 0: Non-loop mode
 - 1: Loop mode
- (R/W)

TRACE_RESTART_ENA Configures whether or not to enable the automatic restart function for the encoder.

- 0: Disable
 - 1: Enable
- (R/W)

Register 2.10. TRACE_RESYNC_PROLONGED_REG (0x0024)

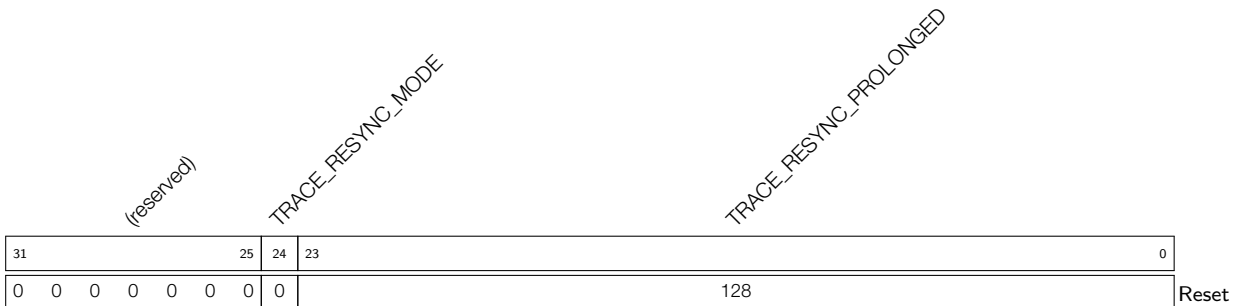

TRACE_RESYNC_PROLONGED Configures the threshold for the synchronization counter. (R/W)

TRACE_RESYNC_MODE Configures the synchronization mode.

- 0: Count by cycle
 - 1: Count by packet
- (R/W)

Register 2.11. TRACE_CLOCK_GATE_REG (0x0028)

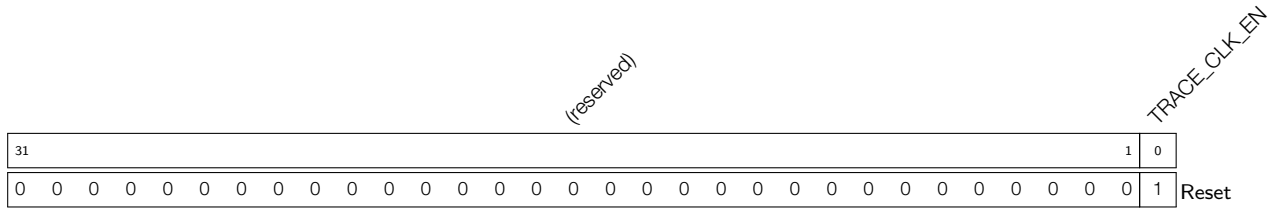

TRACE_CLK_EN Configures register clock gating. 0: Support clock only when the application writes registers to save power.
 1: Always force the clock on for registers.
 This bit doesn't affect register access.
 (R/W)

Register 2.12. TRACE_DATE_REG (0x03FC)

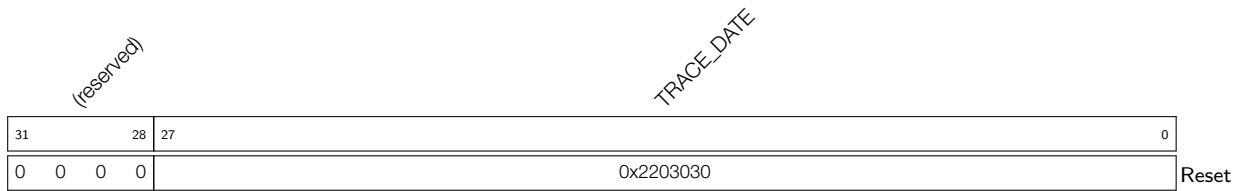

TRACE_DATE Version control register. (R/W)

3 Low-Power CPU

The ESP32-C6 Low-Power CPU (LP CPU) is a 32-bit processor based upon RISC-V ISA comprising integer (I), multiplication/division (M), atomic (A), and compressed (C) standard extensions. It features ultra-low power consumption and has a 2-stage, in-order, and scalar pipeline. The LP CPU core complex has an interrupt controller (INTC), a debug module (DM), and system bus (SYS BUS) interfaces for memory and peripheral access.

The LP CPU is in sleep mode by default (see Section 3.9). It can stay powered on when the chip enters Deep-sleep mode (see Chapter 2 *Low-Power Management [to be added later]* for details) and can access most peripherals and memories (see Chapter 5 *System and Memory* for details). It has two application scenarios:

- Power insensitive scenario: When the High-Performance CPU (HP CPU) is active, the LP CPU can assist the HP CPU with some speed- and efficiency-insensitive controls and computations.
- Power sensitive scenario: When the HP CPU is in the power-down state to save power, the LP CPU can be woken up to handle some external wake-up events.

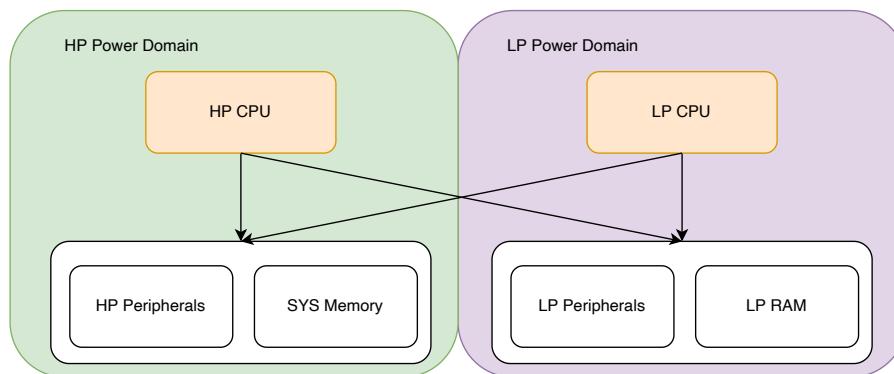

Figure 3-1. LP CPU Overview

3.1 Features

The LP CPU has the following features:

- Operating clock frequency up to 20 MHz
- 19 vector interrupts
- Debug module compliant with RISC-V External Debug Support Version 0.13 with external debugger support over an industry-standard JTAG/USB port
- Hardware trigger compliant with RISC-V External Debug Support Version 0.13 with up to 2 breakpoints/watchpoints
- 32-bit AHB system bus for peripheral and memory access
- Core performance metric events
- Able to wake up the HP CPU and send an interrupt to it
- Access to HP memory and LP memory
- Access to the entire peripheral address space

PRELIMINARY

3.2 Configuration and Status Registers (CSRs)

3.2.1 Register Summary

Below is a list of CSRs available to the CPU. Except for the custom performance counter CSRs, all the implemented CSRs follow the standard mapping of bit fields as described in the RISC-V Instruction Set Manual, Volume II: Privileged Architecture, Version 1.10. It must be noted that even among the standard CSRs, not all bit fields have been implemented, limited by the subset of features implemented in the CPU. Refer to the next section for a detailed description of the subset of fields implemented under each of these CSRs.

Name	Description	Address	Access
Machine Information CSR			
mhartid	Machine Hart ID	0xF14	RO
Machine Trap Setup CSRs			
mstatus	Machine Mode Status	0x300	R/W
misa ⁵	Machine ISA	0x301	R/W
mie	Machine Interrupt Enable	0x304	R/W
mtvec ⁶	Machine Trap Vector	0x305	R/W
Machine Trap Handling CSRs			
mscratch	Machine Scratch	0x340	R/W
mepc	Machine Trap Program Counter	0x341	R/W
mcause ⁷	Machine Trap Cause	0x342	R/W
mtval	Machine Trap Value	0x343	R/W
mip	Machine Interrupt Pending	0x344	R/W
Trigger Module CSRs (shared with Debug Mode)			
tselect	Trigger Select Register	0x7A0	R/W
tdata1	Trigger Abstract Data 1	0x7A1	R/W
tdata2	Trigger Abstract Data 2	0x7A2	R/W
Debug Mode CSRs			
dcsr	Debug Control and Status	0x7B0	R/W
dpc	Debug PC	0x7B1	R/W
dscratch0	Debug Scratch Register 0	0x7B2	R/W
dscratch1	Debug Scratch Register 1	0x7B3	R/W
Machine Counter/Timer CSRs			
mcycle	Machine Clock Cycle Counter	0xB00	R/W
minstret	Machine Retired Instruction Counter	0xB02	R/W
mhpmcounter$n(n:3-12)$	Machine Performance Monitor Counter	0xB00+ n	R/W
mcycleh	The higher 32 bits of mcycle	0xB80	R/W
minstreth	The higher 32 bits of minstret	0xB82	R/W
mhpmcounter$nh(n:3-12)$	The higher 32 bits of mhpmcounter$n(n:3-12)$	0xB80+ n	R/W
Machine Counter Setup CSR			
mcountinhibit	Machine Counter Control	0x320	R/W

⁵Although [misa](#) is specified as having both read and write access (R/W), its fields are hardwired and thus write has no effect. This is what would be termed WARL (Write Any Read Legal) in RISC-V terminology.

⁶[mtvec](#) only provides configuration for trap handling in vectored mode with the base address aligned to 256 bytes.

⁷External interrupt IDs reflected in [mcause](#) include even those IDs which have been reserved by RISC-V standard for core internal sources.

Note that if write, set, or clear operation is attempted on any of the read-only (RO) CSRs indicated in the above table, the CPU will generate an illegal instruction exception.

3.2.2 Registers

Register 3.1. mhartid (0xF14)

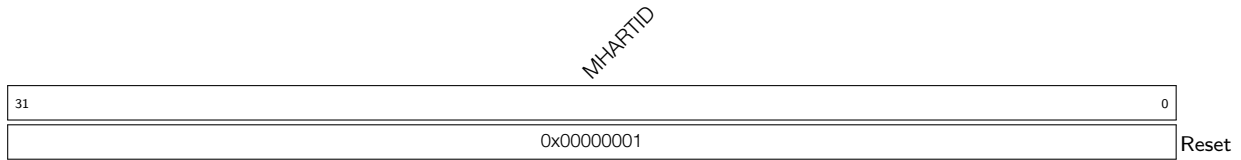

MHARTID Represents Hart ID. The LP CPU hart ID is 1. (RO)

Register 3.2. mstatus (0x300)

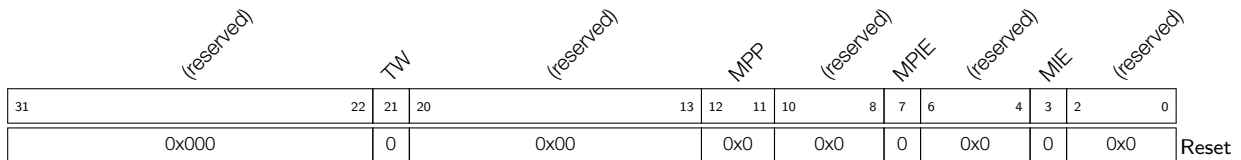

MIE Write 1 to enable the global machine mode interrupt. (R/W)

MPIE Write 1 to enable the machine previous interrupt (before trap). (R/W)

MPP Configures machine previous privilege mode (before trap).

0x3: Machine mode

Other values: Invalid

Note: Only the lower bit is writable. Any write to the higher bit is ignored as it is directly tied to the lower bit.

(R/W)

TW Configures whether to cause illegal instruction exception when WFI (Wait-for-Interrupt) instruction is executed in User mode.

0: Not cause illegal exception in User mode

1: Cause illegal instruction exception

(R/W)

Register 3.3. *misa* (0x301)

MXL		(reserved)																													Z	Y	X	W	V	U	T	S	R	Q	P	O	N	M	L	K	J	I	H	G	F	E	D	C	B	A
31	30	29	28	27	26	25	24	23	22	21	20	19	18	17	16	15	14	13	12	11	10	9	8	7	6	5	4	3	2	1	0																									
0x1		0x0			0	0	0	0	0	0	0	0	0	0	0	0	0	0	0	0	0	0	1	0	0	0	0	0	0	0	1	0	1	Reset																						

- MXL** Machine XLEN = 1 (32-bit). (RO)
- Z** Reserved = 0. (RO)
- Y** Reserved = 0. (RO)
- X** Non-standard extensions present = 0. (RO)
- W** Reserved = 0. (RO)
- V** Reserved = 0. (RO)
- U** User mode implemented = 0. (RO)
- T** Reserved = 0. (RO)
- S** Supervisor mode implemented = 0. (RO)
- R** Reserved = 0. (RO)
- Q** Quad-precision floating-point extension = 0. (RO)
- P** Reserved = 0. (RO)
- O** Reserved = 0. (RO)
- N** User-level interrupts supported = 0. (RO)
- M** Integer Multiply/Divide extension = 1. (RO)
- L** Reserved = 0. (RO)
- K** Reserved = 0. (RO)
- J** Reserved = 0. (RO)
- I** RV32I base ISA = 1. (RO)
- H** Hypervisor extension = 0. (RO)
- G** Additional standard extensions present = 0. (RO)
- F** Single-precision floating-point extension = 0. (RO)
- E** RV32E base ISA = 0. (RO)
- D** Double-precision floating-point extension = 0. (RO)
- C** Compressed Extension = 1. (RO)
- B** Reserved = 0. (RO)
- A** Atomic Standard Extension = 1. (RO)

Register 3.4. mie (0x304)

(reserved)		LIE				(reserved)		EIE		(reserved)		TIE		(reserved)		SIE		(reserved)			
31	30					16	15			11	10			8	7			4	3	2	0
0x0		0x0				0x0		0x0		0x0		0x0		0x0		0x0		0x0		0x0	

Reset

- SIE** Write 1 to enable software interrupts. (R/W)
- TIE** Write 1 to enable timer interrupts. (R/W)
- EIE** Write 1 to enable external interrupts. (R/W)
- LIE** Write 1 to enable the corresponding local interrupt. (R/W)

Register 3.5. mtvec (0x305)

BASE								(reserved)				MODE	
31							8	7			2	1	0
0x0000000								0x00				0x1	

Reset

- MODE** Represents whether machine mode interrupts are vectored. Only vectored mode **0x1** is available. (RO)
- BASE** Configures the higher 24 bits of trap vector base address aligned to 256 bytes. (R/W)

Register 3.6. mscratch (0x340)

MSCRATCH																															
31																															0
0x00000000																															

Reset

- MSCRATCH** Contains machine scratch information for custom use. (R/W)

Register 3.7. mepc (0x341)

MEPC																															
31																															0
0x00000000																															

Reset

- MEPC** Configures the machine trap/exception program counter. This is automatically updated with address of the instruction which was about to be executed while CPU encountered the most recent trap. (R/W)

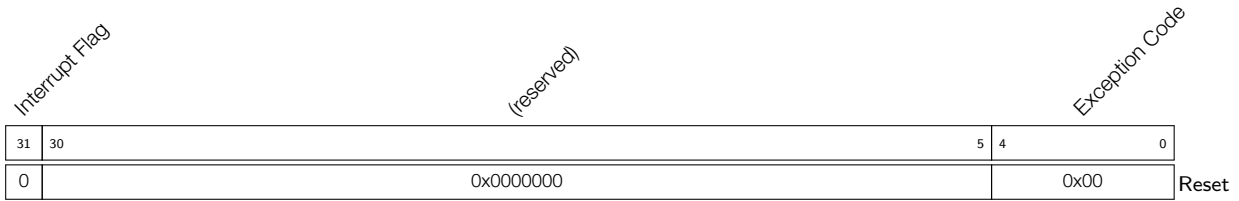
Register 3.8. mcause (0x342)

Exception Code This field is automatically updated with unique ID of the most recent exception or interrupt due to which CPU entered trap. Possible exception IDs are:

0x2: Illegal instruction

0x3: Hardware breakpoint/watchpoint or EBREAK

0x6: Misaligned atomic instructions

Note: Exception ID 0x0 (instruction access misaligned) is not present because CPU always masks the lowest bit of the address during instruction fetch.

(R/W)

Interrupt Flag This flag is automatically updated when CPU enters trap. If this is found to be set, it indicates that the latest trap occurred due to an interrupt. For exceptions it remains unset. (R/W)

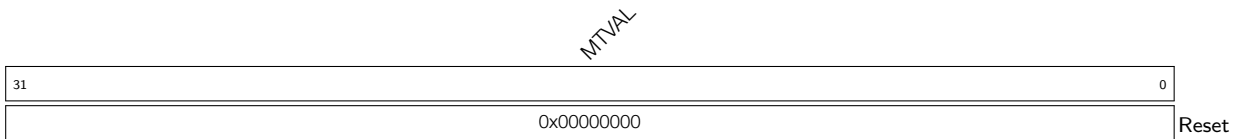
Register 3.9. mtval (0x343)

MTVAL Configures machine trap value. This is automatically updated with an exception dependent data which may be useful for handling that exception. Data is to be interpreted depending upon exception IDs:

0x1: Faulting virtual address of instruction

0x2: Faulting instruction opcode

0x5: Faulting data address of load operation

0x7: Faulting data address of store operation

Note: The value of this register is not valid for other exception IDs and interrupts.

(R/W)

Register 3.10. mip (0x344)

(reserved)		LIP				(reserved)		EIP		(reserved)		TIP		(reserved)		SIP		(reserved)						
31	30					16	15			12	11	10			8	7	6			4	3	2	0	
0x0		0x0				0x0		0x0		0x0		0x0		0x0		0x0		0x0		0x0		0x0		Reset

SIP Configures the pending status of the software interrupt.

0: Not pending

1: Pending

(R/W)

TIP Configures the pending status of the timer interrupt.

0: Not pending

1: Pending

(R/W)

EIP Configures the pending status of the external interrupts.

0: Not pending

1: Pending

(R/W)

LIP Configures the pending status of the local interrupts.

0: Not pending

1: Pending

(R/W)

Register 3.11. mcycle (0xB00)

mcycle	
31	0
0x0	
Reset	

MCYCLE Configures the lower 32 bits of the clock cycle counter. (R/W)

Register 3.12. minstret (0xB02)

minstret	
31	0
0x0	
Reset	

MINSTRET Configures the lower 32 bits of the instruction counter. (R/W)

Register 3.13. mhpmcounter n (n : 3-12) (0xB00+ n)

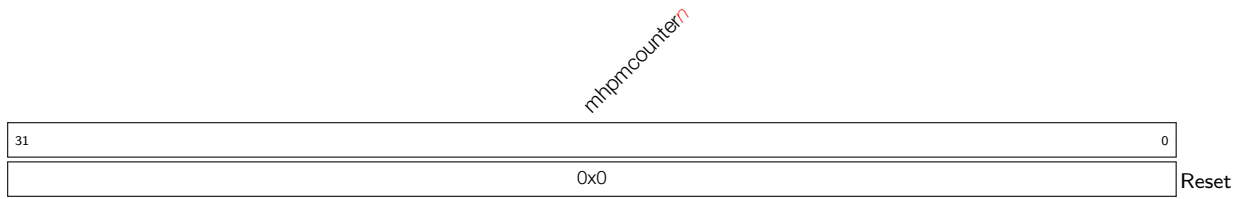

MHPMCOUNTER n Configures the lower 32 bits of the performance counter n . (R/W)

Register 3.14. mcycleh (0xB80)

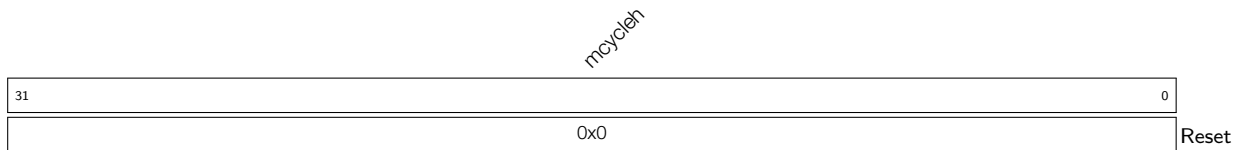

MCYCLEH Configures the higher 32 bits of the clock cycle counter. (R/W)

Register 3.15. minstreth (0xB82)

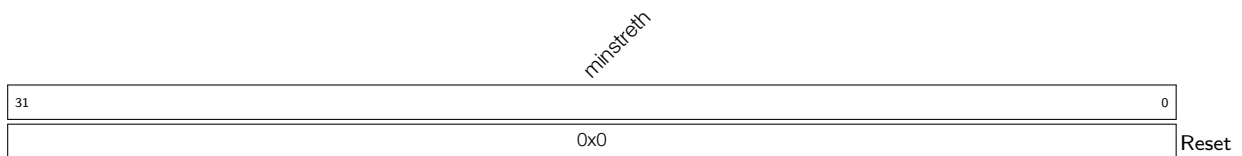

MINSTRETH Configures the higher 32 bits of the instruction counter. (R/W)

Register 3.16. mhpmcounter n (n : 3-12)h (0xB80+ n)

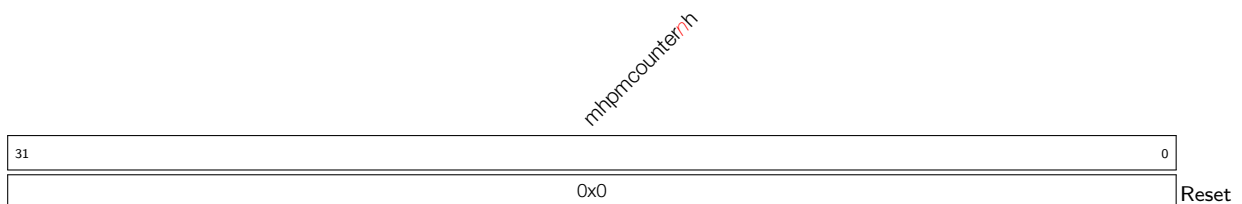

MHPMCOUNTER n h Configures the higher 32 bits of the performance counter n . (R/W)

Register 3.17. mcouninhibit (0x320)

31	HPM	3	2	1	0	
0x0						Reset
		0x0	0x0	0x0		

HPM Configures whether the performance counter $n(n:3-12)$ increments.

- 0: The counter does not count
 - 1: The counter increments
- (R/W)

IR Configure whether the instruction counter increments.

- 0: The counter does not count
 - 1: The counter increments
- (R/W)

CY Configure whether the clock cycle counter increments.

- 0: The counter does not count
 - 1: The counter increments
- (R/W)

3.3 Interrupts and Exceptions

The LP CPU handles interrupts and exceptions according to RISC-V Instruction Set Manual, Volume II: Privileged Architecture, Version 1.10. After entering an interrupt/exception handler, the CPU:

- Saves the current program counter (PC) value to the `mepc` CSR
- Copies the state of `MIE` of `mstatus` to `MPIE` of `mstatus`
- Saves the current privileged mode to `MPP` of `mstatus`
- Clears `MIE` of `mstatus`
- Toggles the privileged mode to machine mode (M mode)
- Jumps to the handler address
 - For exceptions, the handler address is the base address of the vector table in the `mtvec` CSR.
 - For interrupts, the handler address is $mtvec + 4 * ID$, where `ID` is the interrupt ID. For more information, see Section 3.3.1.

After the `mret` instruction is executed, the core jumps to the PC saved in the `mepc` CSR and restores the value of `MPIE` of `mstatus` to `MIE` of `mstatus`.

When the core starts up, the base address of the vector table is initialized to the boot address `0x50000000`. After startup, the base address can be changed by writing to the `mtvec` CSR. For more information about CSRs, see Section 3.2.1.

The core fetches instructions from address `0x50000080` after reset.

3.3.1 Interrupts

The ESP32-C6 LP CPU supports only one interrupt entry, to which all interrupt events jump. The LP CPU supports the following peripheral interrupt sources:

- Power Management Unit (PMU)
- Low-Power Timer (LP_TIMER)
- Low-Power UART (LP_UART)
- Low-Power I2C (LP_I2C)
- Low-Power IO MUX (LP IO MUX)

For more information on those peripheral interrupts, please refer to the corresponding chapter.

3.3.2 Interrupt Handling

By default, interrupts are disabled globally because the MIE bit in `mstatus` has a reset value of 0. Software must set this bit to enable global interrupts.

1. Enable interrupts
 - To enable interrupts globally, set the MIE bit of `mstatus`.
 - To enable Interrupt 30, set the 30th bit of `mie` CSR.
2. After interrupts are enabled, the LP CPU can respond to interrupts. It also needs to configure interrupts of the peripherals so that they can send an interrupt signal to the LP CPU.
3. After the interrupt is triggered, the LP CPU jumps to $mtvec + 4 * 30$.
4. After entering the interrupt handler, users need to read `LPPERI_INTERRUPT_SOURCE_REG` to get the peripheral that triggered the interrupt and process the interrupt. Note that if the interrupts are triggered by multiple peripherals, the CPU will process them one by one in sequence until none is left. If not all interrupts are processed, the CPU will enter the interrupt handler again.
5. To clear interrupts, just clear the interrupt signal of the peripheral.

3.3.3 Exceptions

The LP CPU supports the RISC-V standard exceptions and can trigger the following exceptions:

Table 3-2. LP CPU Exception Causes

Exception ID	Description
2	Illegal instructions
3	Breakpoints (EBREAK)
6	Misaligned atomic instructions
11	Machine-mode environment calls

3.4 Debugging

This section describes how to debug and test the LP CPU. Debug support is provided through standard JTAG pins and complies with RISC-V External Debug Support Version 0.13.

For ESP32-C6 system debugging overview, please refer to Section 1.10 *Debug* > Figure 1-2.

The user interacts with the Debug Host (e.g. laptop), which is running a debugger (e.g., gdb). The debugger communicates with a Debug Translator (e.g. OpenOCD, which may include a hardware driver) to communicate with Debug Transport Hardware (e.g. ESP-Prog adapter). The Debug Transport Hardware connects the Debug Host to the CPU's Debug Transport Module (DTM) through a standard JTAG interface. The DTM provides access to the debug module (DM) using the Debug Module Interface (DMI).

DM supports multi-core debugging in compliance with the specification RISC-V External Debug Support Version 0.13, and can control the HP CPU and the LP CPU simultaneously. Hart 1 represents the LP CPU. Users can use OpenOCD to select a hart (0: HP CPU, 1: LP CPU) for debugging.

The LP CPU implements four registers for core debugging: `dcsr`, `dpc`, `dscratch0`, and `dscratch1`. All of those registers can only be accessed from debug mode. If software attempts to access them when the LP CPU is not in debug mode, an illegal instruction exception will be triggered.

3.4.1 Features

The Low-Power CPU has the following debugging features:

- Provides necessary information about the implementation to the debugger.
- Allows the CPU core to be halted and resumed.
- CPU core registers (including CSRs) can be read/written by the debugger.
- CPU core can be reset through the debugger.
- CPU can be halted on software breakpoint (planted breakpoint instruction).
- Hardware single-stepping.
- Two hardware triggers (which can be used as breakpoints/watchpoints). See Section 3.5 for details.

3.4.2 Functional Description

The debugging mechanism adheres to the specification RISC-V External Debug Support Version 0.13. For a detailed description of the debugging features, refer to the specification.

According to the specification, a hart can be in the following states: nonexistent, unavail, running, and halted. By default, the LP CPU is in the unavail state. To connect the LP CPU for debugging, users need to clear the state by configuring the `LPPERI_CPU_REG` register.

3.4.3 Register Summary

The following table lists the debug CSRs supported for the LP CPU.

Name	Description	Address	Access
<code>dcsr</code>	Debug Control and Status	0x7B0	R/W
<code>dpc</code>	Debug PC	0x7B1	R/W
<code>dscratch0</code>	Debug Scratch Register 0	0x7B2	R/W
<code>dscratch1</code>	Debug Scratch Register 1	0x7B3	R/W

All debug module registers are implemented in accordance with the specification RISC-V External Debug

Support Version 0.13. For more information, refer to the specification.

3.4.4 Registers

The following is a detailed description of the debug CSR supported by the LP CPU.

Register 3.18. dcsr (0x7B0)

31	28	27	(reserved)								16	15	14	13	12	11	9	8	6	5	(reserved)			3	2	1	0			
xdebugver												ebreakm		(reserved)		ebreaku		(reserved)		cause			(reserved)			step	prv	Reset		
0	1	0	0	0	0	0	0	0	0	0	0	0	0	0	0	0	0	0	0	0	0	0	0	0	0	0	0	1	1	

xdebugver Represents the debug version.

4: External debug support exists

(RO)

ebreakm Configures execution of the EBREAK instruction in machine mode.

0: Trigger an exception with mcause = 3

1: Enter debug mode

(R/W)

ebreaku Configures execution of the EBREAK instruction in user mode.

0: Trigger an exception with mcause = 3 as described in privileged mode

1: Enter debug mode

(R/W)

cause Represents the reason why debug mode was entered. When there are multiple reasons to enter debug mode in a single cycle, the cause with the highest priority number is the one written.

1: An EBREAK instruction was executed. (priority 3)

2: The Trigger Module caused a halt. (priority 4)

3: haltreq was set. (priority 2)

4: The CPU core single stepped because step was set. (priority 1)

Other values: reserved for future use

(RO)

step When set and not in Debug Mode, the core will only execute a single instruction and then enter Debug Mode.

If the instruction does not complete due to an exception, the core will immediately enter Debug Mode before executing the trap handler, with appropriate exception registers set.

Setting this bit does not mask interrupts. This is a deviation from the RISC-V External Debug Support Specification Version 0.13.

(R/W)

prv Contains the privilege level the core is operating in when debug mode is entered. A debugger can change this value to change the core's privilege level when exiting debug mode. Only **0x3** (machine mode) and **0x0** (user mode) are supported. (RO)

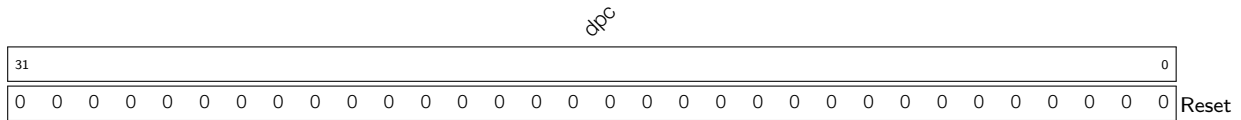
Register 3.19. dpc (0x7B1)

dpc Upon entry to debug mode, dpc is written with the address of the next instruction that will be executed. When resuming, the CPU core's PC is updated to the address stored in dpc. In debug mode, dpc can be modified. This field can be accessed in debug mode. (R/W)

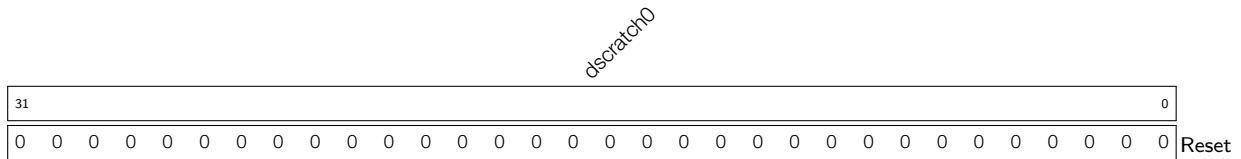
Register 3.20. dscratch0 (0x7B2)

dscratch0 Used by the debug module internally. (R/W)

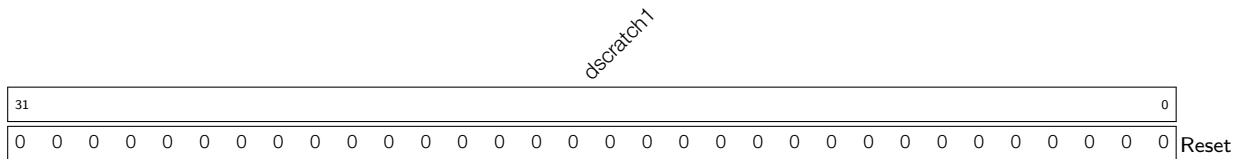
Register 3.21. dscratch1 (0x7B3)

dscratch1 Used by the debug module internally.(R/W)

3.5 Hardware Trigger

3.5.1 Features

Hardware Trigger module provides breakpoint and watchpoint capability for debugging. It has the following features:

- Two independent trigger units
- Configurable unit to match the address of the program counter
- Able to halt execution and transfer control to the debugger

3.5.2 Functional Description

The hardware trigger module provides three CSRs. See Section 3.5 for details. Among these, `tdata1` and `tdata2` are abstract CSRs, which means they are shadow registers for accessing internal registers in the trigger units, one at a time.

To select a specific trigger unit, the corresponding number (0-1) needs to be written to the `tselect` CSR. When a valid value is written, the abstract CSRs, `tdata1` and `tdata2`, automatically match the internal registers of the trigger unit. Each trigger unit has two internal registers, namely `mcontrol` and `maddress`, which are mapped to `tdata1` and `tdata2`, respectively.

Writing a value more than 1 to `tselect` will set `tselect` to 1.

Since software or debugger may need to know the type of the selected trigger to correctly interpret `tdata1` and `tdata2`, the 4-bit field (31-28) of `tdata1` encodes the type of the selected trigger. This type field is read-only and always provides a value of 0x2 for every trigger, which stands for support for address and data matching. Hence, it is inferred that `tdata1` and `tdata2` are to be interpreted as fields of `mcontrol` and `maddress`, respectively. The specification RISC-V External Debug Support Version 0.13 provides information on other possible values, but the trigger module only supports the 0x2 type.

Once a trigger unit has been chosen by writing its index to `tselect`, it will become possible to configure it by setting the appropriate bits in `mcontrol` CSR (`tdata1`) and writing the target address to `maddress` CSR (`tdata2`).

3.5.3 Trigger Execution Flow

When a hart is halted and enters debug mode due to the firing of a trigger (`action = 1`):

- `dpc` is set to the current PC in the decoding phase
- The cause field in `dcsr` is set to 2, which means halt due to trigger

3.5.4 Register Summary

Below is a list of Trigger Module CSRs supported by the CPU. These are only accessible from machine mode.

Name	Description	Address	Access
<code>tselect</code>	Trigger Select Register	0x7A0	R/W
<code>tdata1</code>	Trigger Abstract Data 1	0x7A1	R/W
<code>mcontrol</code>	<code>tdata1</code> Shadow Register	0x7A1	R/W
<code>tdata2</code>	Trigger Abstract Data 2	0x7A2	R/W

3.5.5 Registers

Register 3.22. `tselect` (0x7A0)

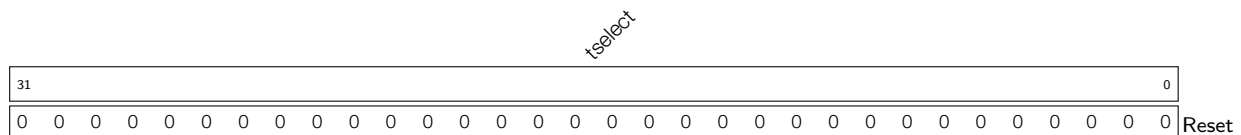

tselect Configures the index of the selected trigger unit. (R/W)

Register 3.23. tdata1 (0x7A1)

type		dmode		data																
31	28	27	26																	0
0 0 1 0		1	0	x 1 0 4																0

type Represents the trigger type. This field is reserved since only match type (0x2) triggers are supported. (RO)

dmode This is set to 1 if a trigger is being used by the debugger. This field is reserved since it is only supported in debug mode. (RO)

data Configures the abstract tdata1 content. This will always be interpreted as fields of [mcontrol](#) since only match type (0x2) triggers are supported. (R/W)

Register 3.24. tdata2 (0x7A2)

tdata2																																	
31																																0	
0 0																																	0

tdata2 Configures the abstract tdata2 content. This will always be interpreted as [maddress](#) since only match type (0x2) triggers are supported. (R/W)

Register 3.25. mcontrol (0x7A1)

(reserved)	dmode	maskmax	hit	select	timing	szelo	action	chain	match	m	(reserved)	s	u	execute	store	load						
31	28	27	26	21	20	19	18	17	16	15	12	11	10	7	6	5	4	3	2	1	0	
0x2	0	0x0	0	0	0	0	0	0001	0	0	0	0	0	0	0	0	0	0	0	0	0	Reset

dmode Same as **dmode** in **tdata1**. (RO)

maskmax Represents the maximum NAPOT range.

0: A byte. Only exact match is supported.

Other values: Not supported.

(RO)

hit Not implemented in hardware. This field remains 0. (RO)

select Configures to select between an address match or a data match.

0: Perform a match on the virtual address

1: Perform a match on the data value loaded or stored, or the instruction executed

Note: Only address match is implemented. This field remains 0.

(RO)

timing Configures when the trigger will take action.

0: Take action before the instruction is executed

1: Take action after the instruction is executed

Note: The field remains 0.

(RO)

szelo Only match of any size is supported. This field remains 0. (RO)

action Configure action of the selected trigger after it is triggered.

0x0: Cause a breakpoint exception

0x1: Enter debug mode (Valid only when **dmode** = 1)

Note: Only entering debug mode is supported. This field remains 1.

(RO)

CHAIN Not implemented in hardware. This field remains 0. (RO)

match Configures the trigger to perform the matching operation of the lower data/instruction address.

0x0: Exact match. Namely, the address corresponding to a certain byte during the access must exactly match the value of **maddress**.

0x1: NAPOT match. Namely, at least one byte during the access is in the NAPOT region specified in **maddress**.

Note: Only exact byte match is supported. This field remains 0.

(R/W)

m Set this field to make the selected trigger operate in machine mode. (RO)

S Set this field to make the selected trigger operate in supervisor mode. Operation in supervisor mode is not supported. This field is always 0. (RO)

Continued on the next page...

Register 3.25. mcontrol (0x7A1)

Continued from the previous page...

U Set this field to make the selected trigger operate in user mode. Operation in user mode is not supported. This field is always 0. (RO)

execute Configures whether to enable the selected trigger to match the virtual address of instructions.
 0: Not enable
 1: Enable
 (R/W)

store Set this field to make the selected trigger match the virtual address of the memory write operation. Not supported by hardware. This field is always 0. (RO)

load Set this field to make the selected trigger match the virtual address of a memory read operation. Not supported by hardware. This field is always 0. (RO)

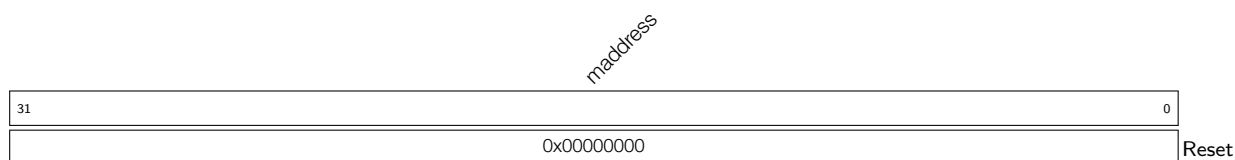
Register 3.26. maddress (0x7A2)

maddress Configures the address used by the selected trigger when performing match operation.
 (R/W)

3.6 Performance Counter

The LP CPU implements a clock cycle counter `mcycle(h)`, an instruction counter `minstret(h)`, and 10 event counters `mhpmcounter n (n :3-12)`. The clock cycle counter and instruction counter are always available and each is 64-bit wide. Other performance counters are 40-bit wide each.

By default, all counters are enabled after reset. A counter can be enabled or disabled individually via the corresponding bit in the `mcountinhibit` CSR.

As shown in Table 3-5, each counter is dedicated to counting a particular event.

Table 3-5. Performance Counter

Counter	Counted Event
<code>mcycle</code>	Clock cycles
<code>minstret</code>	The number of instructions
<code>mhpmcounter3</code>	Wait cycles for memory access
<code>mhpmcounter4</code>	Wait cycles for fetching instructions
<code>mhpmcounter5</code>	The number of memory read operations. An unaligned read is counted as two.

Counter	Counted Event
mhpmcounter6	The number of memory write operations. An unaligned write is counted as two.
mhpmcounter7	The number of unconditional jump instructions (jal, jr, jalr)
mhpmcounter8	The number of branch instructions
mhpmcounter9	The number of taken branch instructions
mhpmcounter10	The number of compressed instructions
mhpmcounter11	Wait cycles for multiplication instructions
mhpmcounter12	Wait cycles for division instructions

3.7 System Access

3.7.1 Memory Access

The ESP32-C6 LP CPU can access LP SRAM and HP SRAM. For more information, please refer to Section 5 [System and Memory](#).

- LP SRAM: 16 KB starting from 0x5000_0000 to 0x5000_3FFF, where you can fetch instructions, read data, write data, etc.
- HP SRAM: 512 KB starting from 0x4080_0000 to 0x4087_FFFF, where you can fetch instructions, read data, write data, etc.

Note:

The LP CPU has a high latency to access the HP SRAM, but can access the LP SRAM with no latency.

The LP CPU supports the atomic instruction set. Both the LP CPU and the HP CPU can access memory through atomic instructions, thus achieving atomicity of memory access. For details on the atomic instruction set, please refer to RISC-V Instruction Set Manual Volume I: Unprivileged ISA, Version 2.2.

3.7.2 Peripheral Access

Table 5-2 in Chapter 5 [System and Memory](#) lists the peripherals accessible by the LP CPU and their base addresses.

3.8 Event Task Matrix Feature

The LP CPU on ESP32-C6 supports the Event Task Matrix (ETM) function, which allows LP CPU's ETM tasks to be triggered by any peripherals' ETM events, or LP CPU's ETM events to trigger any peripherals' ETM tasks. This section introduces the ETM tasks and events related to the LP CPU. For more information, please refer to Chapter 11 [Event Task Matrix \(SOC_ETM\)](#).

LP CPU can receive the following ETM task:

- ULP_TASK_WEAKUP_CPU: Wakes up the LP CPU.

LP CPU can generate the following ETM events:

- ULP_EVT_ERR_INTR: Indicates that an LP CPU exception occurs.
- ULP_EVT_START_INTR: Indicates that the LP CPU clock is turned on.

PRELIMINARY

3.9 Sleep and Wake-Up Process

3.9.1 Features

- Able to sleep, wake up, and operate independently in the low-power system when the HP CPU is sleeping
- Able to actively configure registers to enter the sleep status based on software operating status
- Wake-up events:
 - The HP CPU setting the register REG_HP_TRIGGER_LP
 - The interrupt state of the LP IO
 - ETM events
 - The LP timer timeout
 - The LP UART receiving a certain number of RX pulses when REG_UART_WAKEUP_EN is enabled

3.9.2 Process

The LP CPU is in sleep by default and its wake-up module follows the process below to wake it up for work and make it sleep.

To configure wake-up sources, please refer to Table 3-6.

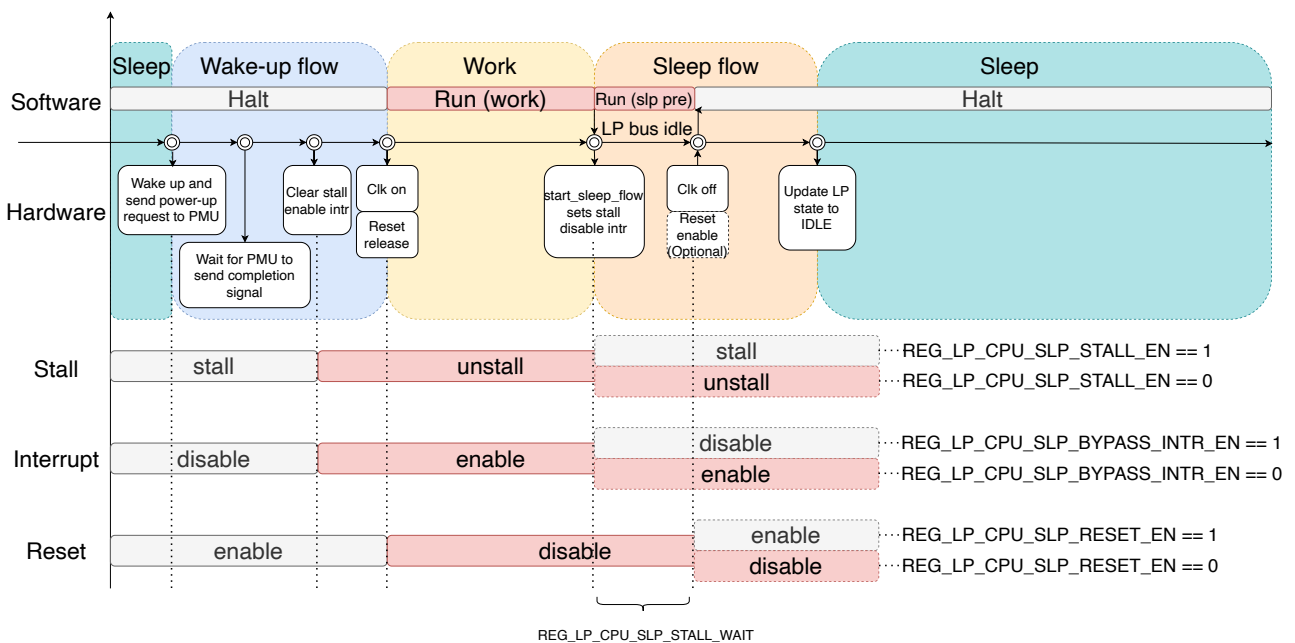

Figure 3-2. Wake-Up and Sleep Flow of LP CPU

The first startup of the LP CPU after power-up depends on the wake-up enable and wake-up source configuration by the HP CPU.

- Initialization of the LP CPU
 - Initialize the LP memory.
 - Start the LP CPU. Since the startup of the LP CPU depends on the wake-up process, it is recommended to use the REG_HP_TRIGGER_LP register to start the initialization of the LP CPU in

the following way:

- * Set REG_LP_CPU_WAKEUP_EN to 0x1
 - * Set REG_HP_TRIGGER_LP to 0x1
 - * The LP CPU will go through the wake-up process to start running
- Wake-up process:
 - The wake-up module receives a wake-up signal and sends a power-up request to the PMU.
 - If the current power consumption state (clock, power supply, etc.) meets the requirements of the LP CPU, the PMU will immediately reply with the completion signal. Otherwise, it will adjust the power consumption state before replying with the completion signal.
 - The wake-up module disables the STALL state of the LP CPU and enables interrupt receiving.
 - The wake-up module starts the clock, releases reset (ignore this step if reset is not enabled for sleep), and starts working.
 - Sleep process:
 - The LP CPU configures the register REG_LP_CPU_SLEEP_REG to enable the wake-up module to start the sleep process.
 - If REG_LP_CPU_SLP_STALL_EN is 1, the wake-up module enables the STALL state of the LP CPU. If it is 0, the module does not enable that state.
 - The wake-up module waits for REG_LP_CPU_SLP_STALL_WAIT LP CPU clock cycles, and then turns off the LP CPU clock. If REG_LP_CPU_SLP_RESET_EN is 1, the module enables reset of the LP CPU.

3.9.3 Wake-Up Sources

Table 3-6. Wake Sources

Register Value ¹	Wake-Up Source	Description
0x1	Register REG_HP_TRIGGER_LP	The HP CPU sets the register REG_HP_TRIGGER_LP to wake up the LP CPU, and sets REG_HP_SW_TRIGGER_INT_CLR to clear this wake-up source.
0x2	LP UART	The LP UART receives a certain number of RX pulses. REG_UART_WAKEUP_EN needs to be enabled. For more information, please refer to Chapter 26 <i>UART Controller (UART, LP_UART, UHCI)</i> .
0x4	LP IO	This wake-up source uses the LP IO interrupt status register signal. For more information, please refer to Chapter 7 <i>IO MUX and GPIO Matrix (GPIO, IO MUX)</i> .
0x8	ETM	Wake-up sources received from ETM can wake up the LP CPU. For more information, please refer to Chapter 11 <i>Event Task Matrix (SOC_ETM)</i> .
0x10	LP timer	LP timer target 1 timeout interrupt control. For more information, please refer to Chapter 2 <i>Low-Power Management [to be added later]</i> .

¹ Value of the REG_LP_CPU_WAKEUP_EN register

3.10 Register Summary

The addresses in this section are relative to Low-Power Peripheral base address provided in Table 5-2 in Chapter 5 *System and Memory*.

Name	Description	Address	Access
LPPERI_CPU_REG	LP CPU Control Register	0x000C	R/W
LPPERI_INTERRUPT_SOURCE_REG	LP CPU Interrupt Status Register	0x0020	RO

3.11 Registers

The addresses in this section are relative to Low-Power Peripheral base address provided in Table 5-2 in Chapter 5 *System and Memory*.

4 GDMA Controller (GDMA)

4.1 Overview

General Direct Memory Access (GDMA) is a feature that allows peripheral-to-memory, memory-to-peripheral, and memory-to-memory data transfer at high speed. The CPU is not involved in the GDMA transfer and therefore is more efficient with less workload.

The GDMA controller in ESP32-C6 has six independent channels, i.e. three transmit channels and three receive channels. These six channels are shared by peripherals with the GDMA feature, and can be assigned to any of such peripherals, including SPI2, UHCI (UART0/UART1), I2S, AES, SHA, ADC, and PARLIO. UART0 and UART1 use UHCI together.

The GDMA controller uses fixed-priority and round-robin channel arbitration schemes to manage peripherals' needs for bandwidth.

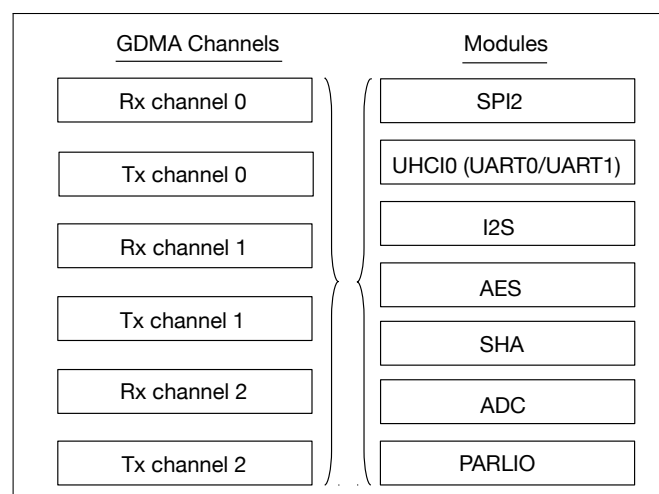

Figure 4-1. Modules with GDMA Feature and GDMA Channels

4.2 Features

The GDMA controller has the following features:

- AHB bus architecture
- Programmable length of data to be transferred in bytes
- Linked list of descriptors
- INCR burst transfer when accessing internal RAM
- Access to an address space of 384 KB at most in internal RAM
- Three transmit channels and three receive channels
- Software-configurable selection of peripheral requesting its service
- Fixed channel priority and round-robin channel arbitration

4.3 Architecture

In ESP32-C6, all modules that need high-speed data transfer support GDMA. The GDMA controller and CPU data bus have access to the same address space in internal RAM. Figure 4-2 shows the basic architecture of the GDMA controller.

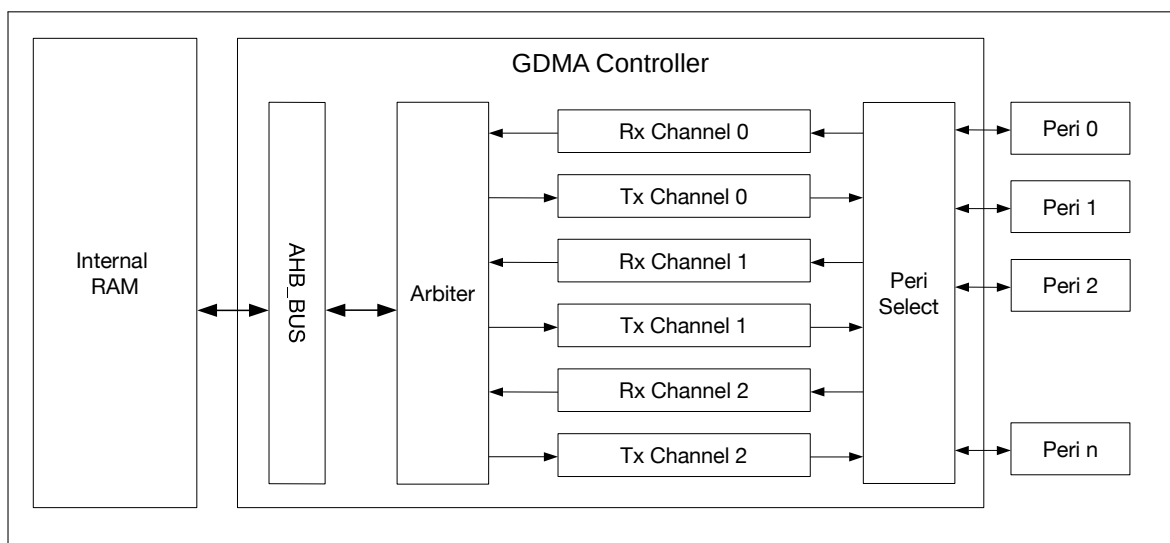

Figure 4-2. GDMA controller Architecture

The GDMA controller has six independent channels, i.e. three transmit channels and three receive channels. Every channel can be connected to different peripherals. In other words, channels are general-purpose, shared by peripherals.

The GDMA controller reads data from or writes data to internal RAM via AHB_BUS. Before this, the GDMA controller uses fixed-priority arbitration scheme for channels requesting read or write access. For available address range of Internal RAM, please see Chapter 5 *System and Memory*.

Software can use the GDMA controller through linked lists. These linked lists, stored in internal RAM, consist of $outlink_n$ and $inlink_n$, where n indicates the channel number (ranging from 0 to 2). The GDMA controller reads an $outlink_n$ (i.e. a linked list of transmit descriptors) from internal RAM and transmits data in corresponding RAM according to the $outlink_n$, or reads an $inlink_n$ (i.e. a linked list of receive descriptors) and stores received data into specific address space in RAM according to the $inlink_n$.

4.4 Functional Description

4.4.1 Linked List

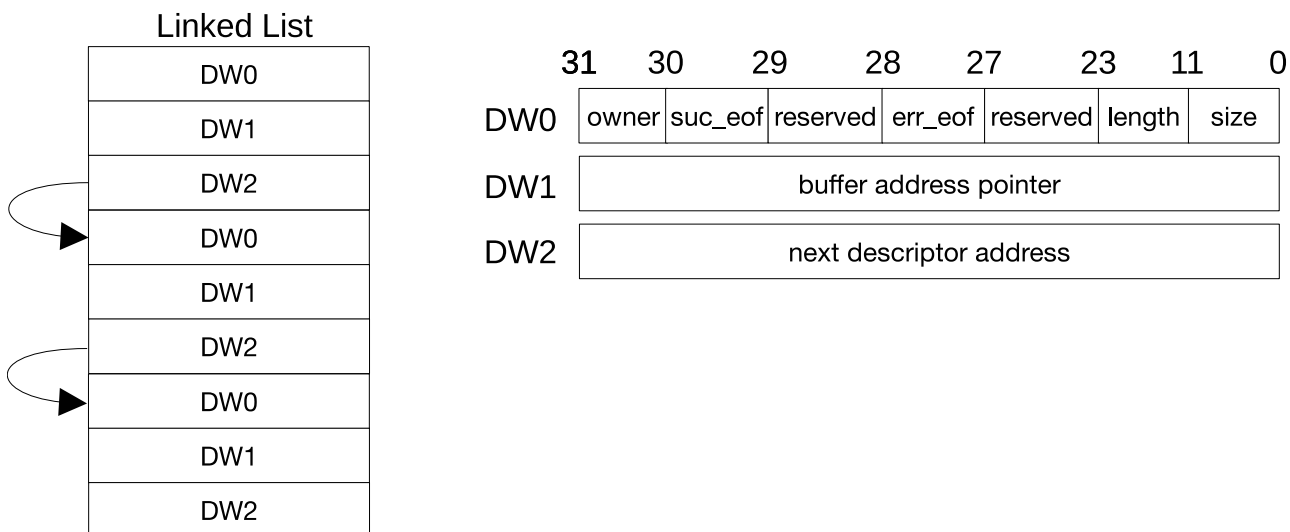

Figure 4-3. Structure of a Linked List

Figure 4-3 shows the structure of a linked list. An outlink and an inlink have the same structure. A linked list is formed by one or more descriptors, and each descriptor consists of three words. Linked lists should be in internal RAM for the GDMA controller to be able to use them. The meanings of a descriptor's fields are as follows:

- owner (DW0) [31]: Specifies who is allowed to access the buffer that this descriptor points to.
 - 0: CPU can access the buffer.
 - 1: The GDMA controller can access the buffer.

When the GDMA controller stops using the buffer, this bit in a receive descriptor is automatically cleared by hardware, and this bit in a transmit descriptor can only be automatically cleared by hardware if `GDMA_OUT_AUTO_WRBACK_CH n` is set to 1. Software can disable automatic clearing by hardware by setting `GDMA_OUT_LOOP_TEST_CH n` or `GDMA_IN_LOOP_TEST_CH n` bit. When software loads a linked list, this bit should be set to 1.

Note: GDMA_OUT is the prefix of transmit channel registers, and GDMA_IN is the prefix of receive channel registers.

- suc_eof (DW0) [30]: Specifies whether this descriptor is the last descriptor of a data frame or packet.
 - 0: This descriptor is not the last one.
 - 1: This descriptor is the last one.
 Software clears suc_eof bit in receive descriptors. When a frame or packet has been received, this bit in the last receive descriptor is set by hardware, and this bit in the last transmit descriptor is set by software.
- reserved (DW0) [29]: Reserved. Value of this bit does not matter.
- err_eof (DW0) [28]: Specifies whether the received data has errors.
 - 0: The received data does not have errors.
 - 1: The received data has errors.
 This bit is used only when UHCI or PARLIO uses GDMA to receive data. When an error is detected in the received frame or packet, this bit in the receive descriptor is set to 1 by hardware.

- reserved (DW0) [27:24]: Reserved.
- length (DW0) [23:12]: Specifies the number of valid bytes in the buffer that this descriptor points to. This field in a transmit descriptor is written by software and indicates how many bytes can be read from the buffer; this field in a receive descriptor is written by hardware automatically and indicates how many valid bytes have been stored into the buffer.
- size (DW0) [11:0]: Specifies the size of the buffer that this descriptor points to.
- buffer address pointer (DW1): Address of the buffer. This field can only point to internal RAM.
- next descriptor address (DW2): Address of the next descriptor. If the current descriptor is the last one (suc_eof = 1), this value is 0. This field can only point to internal RAM.

If the length of data received is smaller than the size of the buffer, the GDMA controller will not use available space of the buffer in the next transaction.

4.4.2 Peripheral-to-Memory and Memory-to-Peripheral Data Transfer

The GDMA controller can transfer data from memory to peripheral (transmit) and from peripheral to memory (receive). A transmit channel transfers data in the specified memory location to a peripheral's transmitter via an outlink n , whereas a receive channel transfers data received by a peripheral to the specified memory location via an inlink n .

Every transmit and receive channel can be connected to any peripheral with GDMA feature. Table 4-1 illustrates how to select the peripheral to be connected via registers. “Dummy- n ” corresponds to register values for memory-to-memory data transfer. When a channel is connected to a peripheral, the rest channels cannot be connected to that peripheral.

Table 4-1. Selecting Peripherals via Register Configuration

GDMA_PERI_IN_SEL_CH n GDMA_PERI_OUT_SEL_CH n	Peripheral
0	SPI2
1	Dummy-1
2	UHCI
3	I2S
4	Dummy-4
5	Dummy-5
6	AES
7	SHA
8	ADC
9	PARLIO
10 ~ 15	Dummy-10 ~ 15
16 ~ 63	Invalid

4.4.3 Memory-to-Memory Data Transfer

The GDMA controller also allows memory-to-memory data transfer. Such data transfer can be enabled by setting GDMA_MEM_TRANS_EN_CH n , which connects the output of transmit channel n to the input of receive channel n . Note that a transmit channel is only connected to the receive channel with the same number (n), and

`GDMA_PERI_IN_SEL_CH n` and `GDMA_PERI_OUT_SEL_CH n` should be configured to the same value corresponding to “Dummy”.

4.4.4 Enabling GDMA

Software uses the GDMA controller through linked lists. When the GDMA controller receives data, software loads an inlink, configures `GDMA_INLINK_ADDR_CH n` field with address of the first receive descriptor, and sets `GDMA_INLINK_START_CH n` bit to enable GDMA. When the GDMA controller transmits data, software loads an outlink, prepares data to be transmitted, configures `GDMA_OUTLINK_ADDR_CH n` field with address of the first transmit descriptor, and sets `GDMA_OUTLINK_START_CH n` bit to enable GDMA. `GDMA_INLINK_START_CH n` bit and `GDMA_OUTLINK_START_CH n` bit are cleared automatically by hardware.

In some cases, you may want to append more descriptors to a DMA transfer that is already started. Naively, it would seem to be possible to do this by clearing the EOF bit of the final descriptor in the existing list and setting its next descriptor address pointer field (DW2) to the first descriptor of the to-be-added list. However, this strategy fails if the existing DMA transfer is almost or entirely finished. Instead, the GDMA controller has specialized logic to make sure a DMA transfer can be continued or restarted: if the transfer is ongoing, the controller will make sure to take the appended descriptors into account; if the transfer has already finished, the controller will restart with the new descriptors. This is implemented by the Restart function.

When using the Restart function, software needs to rewrite address of the first descriptor in the new list to DW2 of the last descriptor in the loaded list, and set `GDMA_INLINK_RESTART_CH n` bit or `GDMA_OUTLINK_RESTART_CH n` bit (these two bits are cleared automatically by hardware). As shown in Figure 4-4, by doing so hardware can obtain the address of the first descriptor in the new list when reading the last descriptor in the loaded list, and then read the new list.

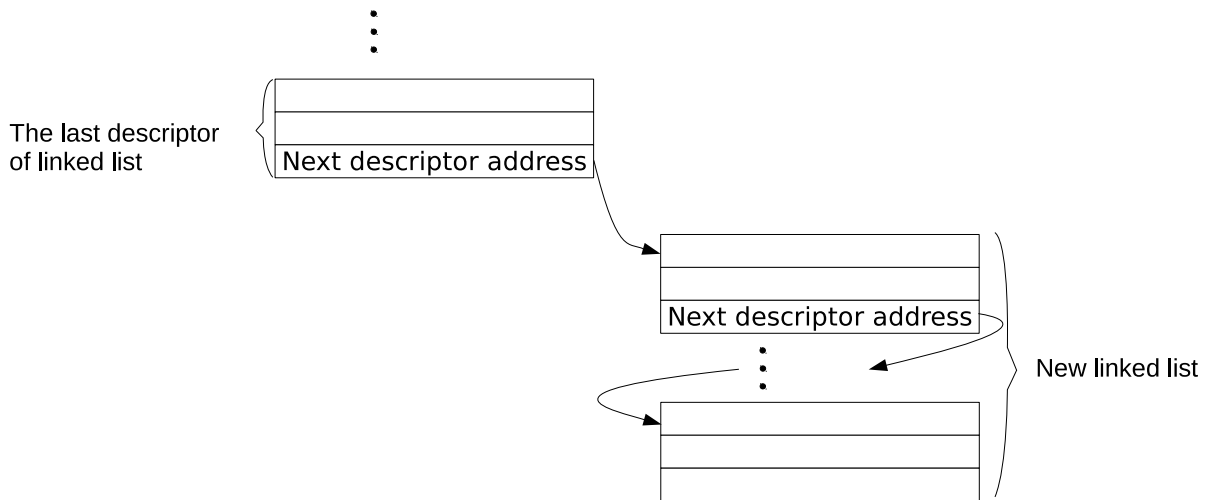

Figure 4-4. Relationship among Linked Lists

4.4.5 Linked List Reading Process

Once configured and enabled by software, the GDMA controller starts to read the linked list from internal RAM. The GDMA performs checks on descriptors in the linked list. Only if descriptors pass the checks, the corresponding GDMA channel will start data transfer. If the descriptors fail any of the checks, hardware will trigger descriptor error interrupt (either `GDMA_IN_DSCR_ERR_CH n _INT` or `GDMA_OUT_DSCR_ERR_CH n _INT`), and the channel will halt.

The checks performed on descriptors are:

- Owner bit check when `GDMA_IN_CHECK_OWNER_CH n` or `GDMA_OUT_CHECK_OWNER_CH n` is set to 1. If the owner bit is 0, the buffer is accessed by the CPU. In this case, the owner bit fails the check. The owner bit will not be checked if `GDMA_IN_CHECK_OWNER_CH n` or `GDMA_OUT_CHECK_OWNER_CH n` is 0.
- Buffer address pointer (DW1) check. If the buffer address pointer points to `0x40800000 ~ 0x4087FFFF` (please refer to Section 4.4.7), it passes the check. Otherwise it fails the check.

After software detects a descriptor error interrupt, it must reset the corresponding channel, and enable GDMA by setting `GDMA_OUTLINK_START_CH n` or `GDMA_INLINK_START_CH n` bit.

Note: The third word (DW2) in a descriptor can only point to a location in internal RAM, given that the third word points to the next descriptor to use and that all descriptors must be in internal memory.

4.4.6 EOF

The GDMA controller uses EOF (end of frame) flags to indicate the end of data frame or packet transmission.

Before the GDMA controller transmits data, `GDMA_OUT_TOTAL_EOF_CH n _INT_ENA` bit should be set to enable `GDMA_OUT_TOTAL_EOF_CH n _INT` interrupt. If data in the buffer pointed by the last descriptor (with EOF) has been transmitted, a `GDMA_OUT_TOTAL_EOF_CH n _INT` interrupt is generated.

Before the GDMA controller receives data, `GDMA_IN_SUC_EOF_CH n _INT_ENA` bit should be set to enable `GDMA_IN_SUC_EOF_CH n _INT` interrupt. If a data frame or packet has been received successfully, a `GDMA_IN_SUC_EOF_CH n _INT` interrupt is generated. In addition, when GDMA channel is connected to UHCI or PARLIO, the GDMA controller also supports `GDMA_IN_ERR_CH n _EOF_INT` interrupt. This interrupt is enabled by setting `GDMA_IN_ERR_EOF_CH n _INT_ENA` bit, and it indicates that a data frame or packet has been received with errors.

When detecting a `GDMA_OUT_TOTAL_EOF_CH n _INT` or a `GDMA_IN_SUC_EOF_CH n _INT` interrupt, software can record the value of `GDMA_OUT_EOF_DES_ADDR_CH n` or `GDMA_IN_SUC_EOF_DES_ADDR_CH n` field, i.e. address of the last descriptor. Therefore, software can tell which descriptors have been used and reclaim them as needed.

Note: In this chapter, EOF of transmit descriptors refers to `suc_eof`, while EOF of receive descriptors refers to both `suc_eof` and `err_eof`.

4.4.7 Accessing Internal RAM

Any transmit and receive channels of GDMA can access `0x40800000 ~ 0x4087FFFF` in internal RAM. To improve data transfer efficiency, GDMA can send data in burst mode, which is disabled by default. This mode is enabled for receive channels by setting `GDMA_IN_DATA_BURST_EN_CH n` , and enabled for transmit channels by setting `GDMA_OUT_DATA_BURST_EN_CH n` .

Table 4-2. Descriptor Field Alignment Requirements

Inlink/Outlink	Burst Mode	Size	Length	Buffer Address Pointer
Inlink	0	—	—	—
	1	Word-aligned	—	Word-aligned

Outlink	0	—	—	—
	1	—	—	—

Table 4-2 lists the requirements for descriptor field alignment when accessing internal RAM.

When burst mode is disabled, size, length, and buffer address pointer in both transmit and receive descriptors do not need to be word-aligned. That is, for a descriptor, GDMA can read data of specified length (1 ~ 4095 bytes) from any start addresses in the accessible address range, or write received data of the specified length (1 ~ 4095 bytes) to any contiguous addresses in the accessible address range.

When burst mode is enabled, size, length, and buffer address pointer in transmit descriptors are also not necessarily word-aligned. However, size and buffer address pointer in receive descriptors except length should be word-aligned.

4.4.8 Arbitration

To ensure timely response to peripherals running at a high speed with low latency (such as SPI), the GDMA controller implements a fixed-priority channel arbitration scheme. That is to say, each channel can be assigned a priority from 0 ~ 5 (in total 6 levels). The larger the number, the higher the priority, and the more timely the response. When several channels are assigned the same priority, the GDMA controller adopts a round-robin arbitration scheme.

4.4.9 Event Task Matrix Feature

The GDMA controller on ESP32-C6 supports the Event Task Matrix (ETM) function, which allows GDMA's ETM tasks to be triggered by any peripherals' ETM events, or GDMA's ETM events to trigger any peripherals' ETM tasks. This section introduces the ETM tasks and events related to GDMA. For more information, please refer to Chapter 11 [Event Task Matrix \(SOC_ETM\)](#).

GDMA can receive the following ETM tasks:

- `GDMA_TASK_IN_START_CH n` : Enables the corresponding RX channel n for data transfer.
- `GDMA_TASK_OUT_START_CH n` : Enables the corresponding TX channel n for data transfer.

Note:

Above ETM tasks can achieve the same functions as CPU configuring `GDMA_INLNK_START_CH n` and `GDMA_OUTLNK_START_CH n` . When `GDMA_IN_ETM_EN_CH n` or `GDMA_OUT_ETM_EN_CH n` is 1, only ETM tasks can be used to configure the transfer direction and enable the corresponding GDMA channel. When `GDMA_IN_ETM_EN_CH n` or `GDMA_OUT_ETM_EN_CH n` is 0, only CPU can be used to enable the corresponding GDMA channel.

GDMA can generate the following ETM events:

- `GDMA_EVT_IN_DONE_CH n` : Indicates that the data has been received according to the receive descriptor via channel n .
- `GDMA_EVT_IN_SUC_EOF_CH n` : Indicates that the data corresponding to a receive descriptor has been received via channel n and the EOF bit of this descriptor is 1.
- `GDMA_EVT_IN_FIFO_EMPTY_CH n` : Indicates that the RX FIFO has become empty.

- `GDMA_EVT_IN_FIFO_FULL_CH n` : Indicates that the RX FIFO has become full.
- `GDMA_EVT_OUT_DONE_CH n` : Indicates that the data has been transmitted according to the transmit descriptor via channel n .
- `GDMA_EVT_OUT_SUC_EOF_CH n` : Indicates that the data corresponding to a transmit descriptor has been transmitted or received via channel n and the EOF bit of this descriptor is 1.
- `GDMA_EVT_OUT_TOTAL_EOF_CH n` : Indicates that the data corresponding to the last transmit descriptors has been sent via transmit channel n and the EOF bit of this descriptor is 1.
- `GDMA_EVT_OUT_FIFO_EMPTY_CH n` : Indicates that the TX FIFO has become empty.
- `GDMA_EVT_OUT_FIFO_FULL_CH n` : Indicates that the TX FIFO has become full.

In practical applications, GDMA's ETM events can trigger its own ETM tasks. For example, the `GDMA_EVT_OUT_TOTAL_EOF_CH0` event can trigger the `GDMA_TASK_IN_START_CH1` task, and in this way trigger a new round of GDMA operations.

4.5 GDMA Interrupts

- `GDMA_OUT_TOTAL_EOF_CH n _INT`: Triggered when all data corresponding to a linked list (including multiple descriptors) has been sent via transmit channel n .
- `GDMA_IN_DSCR_EMPTY_CH n _INT`: Triggered when the size of the buffer pointed by receive descriptors is smaller than the length of data to be received via receive channel n .
- `GDMA_OUT_DSCR_ERR_CH n _INT`: Triggered when an error is detected in a transmit descriptor on transmit channel n .
- `GDMA_IN_DSCR_ERR_CH n _INT`: Triggered when an error is detected in a receive descriptor on receive channel n .
- `GDMA_OUT_EOF_CH n _INT`: Triggered when EOF in a transmit descriptor is 1 and data corresponding to this descriptor has been sent via transmit channel n . If `GDMA_OUT_EOF_MODE_CH n` is 0, this interrupt will be triggered when the last byte of data corresponding to this descriptor enters GDMA's transmit channel; if `GDMA_OUT_EOF_MODE_CH n` is 1, this interrupt is triggered when the last byte of data is taken from GDMA's transmit channel.
- `GDMA_OUT_DONE_CH n _INT`: Triggered when all data corresponding to a transmit descriptor has been sent via transmit channel n .
- `GDMA_IN_ERR_EOF_CH n _INT`: Triggered when an error is detected in the data frame or packet received via receive channel n . This interrupt is used only for UHCI peripheral (UART0 or UART1) or PARLIO.
- `GDMA_IN_SUC_EOF_CH n _INT`: Triggered when the `suc_eof` bit in a receive descriptor is 1 and the data corresponding to this receive descriptor has been received (i.e. when the data frame or packet corresponding to an inlink has been received) via receive channel n .
- `GDMA_IN_DONE_CH n _INT`: Triggered when all data corresponding to a receive descriptor has been received via receive channel n .

4.6 Programming Procedures

The clock gating for GDMA can be configured via `PCR_GDMA_CLK_EN`, and is enabled by default. GDMA can be reset by configuring `PCR_GDMA_RST_EN`.

4.6.1 Programming Procedures for GDMA's Transmit Channel

To transmit data, GDMA's transmit channel should be configured by software as follows:

1. Set `GDMA_OUT_RST_CH n` first to 1 and then to 0, to reset the state machine of GDMA's transmit channel and FIFO pointer.
2. Load an outlink, and configure `GDMA_OUTLINK_ADDR_CH n` with address of the first transmit descriptor.
3. Configure `GDMA_PERI_OUT_SEL_CH n` with the value corresponding to the peripheral to be connected, as shown in Table 4-1.
4. Set `GDMA_OUTLINK_START_CH n` to enable GDMA's transmit channel for data transfer.
5. Configure and enable the corresponding peripheral (SPI2, UHCI (UART0 or UART1), I2S, AES, SHA, and ADC). See details in individual chapters of these peripherals.
6. Wait for `GDMA_OUT_EOF_CH n _INT` interrupt, which indicates the completion of data transfer.

4.6.2 Programming Procedures for GDMA's Receive Channel

To receive data, GDMA's receive channel should be configured by software as follows:

1. Set `GDMA_IN_RST_CH n` first to 1 and then to 0, to reset the state machine of GDMA's receive channel and FIFO pointer.
2. Load an inlink, and configure `GDMA_INLINK_ADDR_CH n` with address of the first receive descriptor.
3. Configure `GDMA_PERI_IN_SEL_CH n` with the value corresponding to the peripheral to be connected, as shown in Table 4-1.
4. Set `GDMA_INLINK_START_CH n` to enable GDMA's receive channel for data transfer.
5. Configure and enable the corresponding peripheral (SPI2, UHCI (UART0 or UART1), I2S, AES, SHA, and ADC). See details in individual chapters of these peripherals.
6. Wait for `GDMA_IN_SUC_EOF_CH n _INT` interrupt, which indicates that a data frame or packet has been received.

4.6.3 Programming Procedures for Memory-to-Memory Transfer

To transfer data from one memory location to another, GDMA should be configured by software as follows:

1. Set `GDMA_OUT_RST_CH n` first to 1 and then to 0, to reset the state machine of GDMA's transmit channel and FIFO pointer.
2. Set `GDMA_IN_RST_CH n` first to 1 and then to 0, to reset the state machine of GDMA's receive channel and FIFO pointer.
3. Load an outlink, and configure `GDMA_OUTLINK_ADDR_CH n` with address of the first transmit descriptor.
4. Load an inlink, and configure `GDMA_INLINK_ADDR_CH n` with address of the first receive descriptor.

5. Set `GDMA_MEM_TRANS_EN_CHn` to enable memory-to-memory transfer.
6. Set `GDMA_OUTLINK_START_CHn` to enable GDMA's transmit channel for data transfer.
7. Set `GDMA_INLINK_START_CHn` to enable GDMA's receive channel for data transfer.
8. Wait for `GDMA_IN_SUC_EOF_CHn_INT` interrupt, which indicates that a data transaction has been completed.

4.7 Register Summary

The addresses in this section are relative to GDMA base address provided in Table 5-2 in Chapter 5 *System and Memory*.

The abbreviations given in Column **Access** are explained in Section *Access Types for Registers*.

Name	Description	Address	Access
Interrupt Registers			
GDMA_IN_INT_RAW_CH0_REG	Raw interrupt status of RX channel 0	0x0000	R/WTC/SS
GDMA_IN_INT_ST_CH0_REG	Masked interrupt status of RX channel 0	0x0004	RO
GDMA_IN_INT_ENA_CH0_REG	Interrupt enable bits of RX channel 0	0x0008	R/W
GDMA_IN_INT_CLR_CH0_REG	Interrupt clear bits of RX channel 0	0x000C	WT
GDMA_IN_INT_RAW_CH1_REG	Raw interrupt status interrupt of TX channel 1	0x0010	R/WTC/SS
GDMA_IN_INT_ST_CH1_REG	Masked interrupt status of TX channel 1	0x0014	RO
GDMA_IN_INT_ENA_CH1_REG	Interrupt enable bits of TX channel 1	0x0018	R/W
GDMA_IN_INT_CLR_CH1_REG	Interrupt clear bits of TX channel 1	0x001C	WT
GDMA_IN_INT_RAW_CH2_REG	Raw interrupt status of RX channel 2	0x0020	R/WTC/SS
GDMA_IN_INT_ST_CH2_REG	Masked interrupt status of RX channel 2	0x0024	RO
GDMA_IN_INT_ENA_CH2_REG	Interrupt enable bits of RX channel 2	0x0028	R/W
GDMA_IN_INT_CLR_CH2_REG	Interrupt clear bits of RX channel 2	0x002C	WT
GDMA_OUT_INT_RAW_CH0_REG	Raw interrupt status of TX channel 0	0x0030	R/WTC/SS
GDMA_OUT_INT_ST_CH0_REG	Masked interrupt status of TX channel 0	0x0034	RO
GDMA_OUT_INT_ENA_CH0_REG	Interrupt enable bits of TX channel 0	0x0038	R/W
GDMA_OUT_INT_CLR_CH0_REG	Interrupt clear bits of TX channel 0	0x003C	WT
GDMA_OUT_INT_RAW_CH1_REG	Raw interrupt status of TX channel 1	0x0040	R/WTC/SS
GDMA_OUT_INT_ST_CH1_REG	Masked interrupt status of TX channel 1	0x0044	RO
GDMA_OUT_INT_ENA_CH1_REG	Interrupt enable bits of TX channel 1	0x0048	R/W
GDMA_OUT_INT_CLR_CH1_REG	Interrupt clear bits of TX channel 1	0x004C	WT
GDMA_OUT_INT_RAW_CH2_REG	Raw interrupt status of TX channel 2	0x0050	R/WTC/SS
GDMA_OUT_INT_ST_CH2_REG	Masked interrupt status of TX channel 2	0x0054	RO
GDMA_OUT_INT_ENA_CH2_REG	Interrupt enable bits of TX channel 2	0x0058	R/W
GDMA_OUT_INT_CLR_CH2_REG	Interrupt clear bits of TX channel 2	0x005C	WT
Debug Registers			
GDMA_AHB_TEST_REG	Reserved	0x0060	R/W
Configuration Registers			
GDMA_MISC_CONF_REG	Miscellaneous register	0x0064	R/W
GDMA_IN_CONF0_CH0_REG	Configuration register 0 of RX channel 0	0x0070	R/W
GDMA_IN_CONF1_CH0_REG	Configuration register 1 of RX channel 0	0x0074	R/W
GDMA_IN_POP_CH0_REG	Pop control register of RX channel 0	0x007C	varies
GDMA_IN_LINK_CH0_REG	Linked list descriptor configuration and control register of RX channel 0	0x0080	varies
GDMA_OUT_CONF0_CH0_REG	Configuration register 0 of TX channel 0	0x00D0	R/W
GDMA_OUT_CONF1_CH0_REG	Configuration register 1 of TX channel 0	0x00D4	R/W
GDMA_OUT_PUSH_CH0_REG	Push control register of RX channel 0	0x00DC	varies

Name	Description	Address	Access
GDMA_OUT_LINK_CH0_REG	Linked list descriptor configuration and control register of TX channel 0	0x00E0	varies
GDMA_IN_CONF0_CH1_REG	Configuration register 0 of RX channel 1	0x0130	R/W
GDMA_IN_CONF1_CH1_REG	Configuration register 1 of RX channel 1	0x0134	R/W
GDMA_IN_POP_CH1_REG	Pop control register of RX channel 1	0x013C	varies
GDMA_IN_LINK_CH1_REG	Linked list descriptor configuration and control register of RX channel 1	0x0140	varies
GDMA_OUT_CONF0_CH1_REG	Configuration register 0 of TX channel 1	0x0190	R/W
GDMA_OUT_CONF1_CH1_REG	Configuration register 1 of TX channel 1	0x0194	R/W
GDMA_OUT_PUSH_CH1_REG	Push control register of RX channel 1	0x019C	varies
GDMA_OUT_LINK_CH1_REG	Linked list descriptor configuration and control register of TX channel 1	0x01A0	varies
GDMA_IN_CONF0_CH2_REG	Configuration register 0 of RX channel 2	0x01F0	R/W
GDMA_IN_CONF1_CH2_REG	Configuration register 1 of RX channel 2	0x01F4	R/W
GDMA_IN_POP_CH2_REG	Pop control register of RX channel 2	0x01FC	varies
GDMA_IN_LINK_CH2_REG	Linked list descriptor configuration and control register of RX channel 2	0x0200	varies
GDMA_OUT_CONF0_CH2_REG	Configuration register 0 of TX channel 2	0x0250	R/W
GDMA_OUT_CONF1_CH2_REG	Configuration register 1 of TX channel 2	0x0254	R/W
GDMA_OUT_PUSH_CH2_REG	Push control register of RX channel 2	0x025C	varies
GDMA_OUT_LINK_CH2_REG	Linked list descriptor configuration and control register of TX channel 2	0x0260	varies
Version Register			
GDMA_DATE_REG	Version control register	0x0068	R/W
Status Registers			
GDMA_INFIFO_STATUS_CH0_REG	Receive FIFO status of RX channel 0	0x0078	RO
GDMA_IN_STATE_CH0_REG	Receive status of RX channel 0	0x0084	RO
GDMA_IN_SUC_EOF_DES_ADDR_CH0_REG	Receive descriptor address when EOF occurs on RX channel 0	0x0088	RO
GDMA_IN_ERR_EOF_DES_ADDR_CH0_REG	Receive descriptor address when errors occur of RX channel 0	0x008C	RO
GDMA_IN_DSCR_CH0_REG	Address of the next receive descriptor pointed by the current pre-read receive descriptor on RX channel 0	0x0090	RO
GDMA_IN_DSCR_BF0_CH0_REG	Address of the current pre-read receive descriptor on RX channel 0	0x0094	RO
GDMA_IN_DSCR_BF1_CH0_REG	Address of the previous pre-read receive descriptor on RX channel 0	0x0098	RO
GDMA_OUTFIFO_STATUS_CH0_REG	Transmit FIFO status of TX channel 0	0x00D8	RO
GDMA_OUT_STATE_CH0_REG	Transmit status of TX channel 0	0x00E4	RO
GDMA_OUT_EOF_DES_ADDR_CH0_REG	Transmit descriptor address when EOF occurs on TX channel 0	0x00E8	RO
GDMA_OUT_EOF_BFR_DES_ADDR_CH0_REG	The last transmit descriptor address when EOF occurs on TX channel 0	0x00EC	RO

Name	Description	Address	Access
GDMA_OUT_DSCR_CH0_REG	Address of the next transmit descriptor pointed by the current pre-read transmit descriptor on TX channel 0	0x00F0	RO
GDMA_OUT_DSCR_BF0_CH0_REG	Address of the current pre-read transmit descriptor on TX channel 0	0x00F4	RO
GDMA_OUT_DSCR_BF1_CH0_REG	Address of the previous pre-read transmit descriptor on TX channel 0	0x00F8	RO
GDMA_INFIFO_STATUS_CH1_REG	Receive FIFO status of RX channel 1	0x0138	RO
GDMA_IN_STATE_CH1_REG	Receive status of RX channel 1	0x0144	RO
GDMA_IN_SUC_EOF_DES_ADDR_CH1_REG	Receive descriptor address when EOF occurs on RX channel 1	0x0148	RO
GDMA_IN_ERR_EOF_DES_ADDR_CH1_REG	Receive descriptor address when errors occur of RX channel 1	0x014C	RO
GDMA_IN_DSCR_CH1_REG	Address of the next receive descriptor pointed by the current pre-read receive descriptor on RX channel 1	0x0150	RO
GDMA_IN_DSCR_BF0_CH1_REG	Address of the current pre-read receive descriptor on RX channel 1	0x0154	RO
GDMA_IN_DSCR_BF1_CH1_REG	Address of the previous pre-read receive descriptor on RX channel 1	0x0158	RO
GDMA_OUTFIFO_STATUS_CH1_REG	Transmit FIFO status of TX channel 1	0x0198	RO
GDMA_OUT_STATE_CH1_REG	Transmit status of TX channel 1	0x01A4	RO
GDMA_OUT_EOF_DES_ADDR_CH1_REG	Transmit descriptor address when EOF occurs on TX channel 1	0x01A8	RO
GDMA_OUT_EOF_BFR_DES_ADDR_CH1_REG	The last transmit descriptor address when EOF occurs on TX channel 1	0x01AC	RO
GDMA_OUT_DSCR_CH1_REG	Address of the next transmit descriptor pointed by the current pre-read transmit descriptor on TX channel 1	0x01B0	RO
GDMA_OUT_DSCR_BF0_CH1_REG	Address of the current pre-read transmit descriptor on TX channel 1	0x01B4	RO
GDMA_OUT_DSCR_BF1_CH1_REG	Address of the previous pre-read transmit descriptor on TX channel 1	0x01B8	RO
GDMA_INFIFO_STATUS_CH2_REG	Receive FIFO status of RX channel 2	0x01F8	RO
GDMA_IN_STATE_CH2_REG	Receive status of RX channel 2	0x0204	RO
GDMA_IN_SUC_EOF_DES_ADDR_CH2_REG	Receive descriptor address when EOF occurs on RX channel 2	0x0208	RO
GDMA_IN_ERR_EOF_DES_ADDR_CH2_REG	Receive descriptor address when errors occur of RX channel 2	0x020C	RO
GDMA_IN_DSCR_CH2_REG	Address of the next receive descriptor pointed by the current pre-read receive descriptor on RX channel 2	0x0210	RO
GDMA_IN_DSCR_BF0_CH2_REG	Address of the current pre-read receive descriptor on RX channel 2	0x0214	RO

Name	Description	Address	Access
GDMA_IN_DSCR_BF1_CH2_REG	Address of the previous pre-read receive descriptor on RX channel 2	0x0218	RO
GDMA_OUTFIFO_STATUS_CH2_REG	Transmit FIFO status of TX channel 2	0x0258	RO
GDMA_OUT_STATE_CH2_REG	Transmit status of TX channel 2	0x0264	RO
GDMA_OUT_EOF_DES_ADDR_CH2_REG	Transmit descriptor address when EOF occurs on TX channel 2	0x0268	RO
GDMA_OUT_EOF_BFR_DES_ADDR_CH2_REG	The last transmit descriptor address when EOF occurs on TX channel 2	0x026C	RO
GDMA_OUT_DSCR_CH2_REG	Address of the next transmit descriptor pointed by the current pre-read transmit descriptor on TX channel 2	0x0270	RO
GDMA_OUT_DSCR_BF0_CH2_REG	Address of the current pre-read transmit descriptor on TX channel 2	0x0274	RO
GDMA_OUT_DSCR_BF1_CH2_REG	Address of the previous pre-read transmit descriptor on TX channel 2	0x0278	RO
Priority Registers			
GDMA_IN_PRI_CH0_REG	Priority register of RX channel 0	0x009C	R/W
GDMA_OUT_PRI_CH0_REG	Priority register of TX channel 0	0x00FC	R/W
GDMA_IN_PRI_CH1_REG	Priority register of RX channel 1	0x015C	R/W
GDMA_OUT_PRI_CH1_REG	Priority register of TX channel 1	0x01BC	R/W
GDMA_IN_PRI_CH2_REG	Priority register of RX channel 2	0x021C	R/W
GDMA_OUT_PRI_CH2_REG	Priority register of TX channel 2	0x027C	R/W
Peripheral Selection Registers			
GDMA_IN_PERI_SEL_CH0_REG	Peripheral selection register of RX channel 0	0x00A0	R/W
GDMA_OUT_PERI_SEL_CH0_REG	Peripheral selection register of TX channel 0	0x0100	R/W
GDMA_IN_PERI_SEL_CH1_REG	Peripheral selection register of RX channel 1	0x0160	R/W
GDMA_OUT_PERI_SEL_CH1_REG	Peripheral selection register of TX channel 1	0x01C0	R/W
GDMA_IN_PERI_SEL_CH2_REG	Peripheral selection register of RX channel 2	0x0220	R/W
GDMA_OUT_PERI_SEL_CH2_REG	Peripheral selection register of TX channel 2	0x0280	R/W

Register 4.2. GDMA_IN_INT_ST_CH n _REG (n : 0-2) (0x0004+0x10* n)

(reserved)																						GDMA_IN_FIFO_UDF_CH0_INT_ST GDMA_IN_FIFO_OVF_CH0_INT_ST GDMA_IN_DSCR_EMPTY_CH0_INT_ST GDMA_IN_DSCR_ERR_CH0_INT_ST GDMA_IN_SUC_EOF_CH0_INT_ST GDMA_IN_DONE_CH0_INT_ST																				
31																						7		6	5	4	3	2	1	0												Reset
0																						0		0	0	0	0	0	0	0												0

GDMA_IN_DONE_CH n _INT_ST The masked interrupt status of GDMA_IN_DONE_CH n _INT. (RO)

GDMA_IN_SUC_EOF_CH n _INT_ST The masked interrupt status of GDMA_IN_SUC_EOF_CH n _INT.
(RO)

GDMA_IN_ERR_EOF_CH n _INT_ST The masked interrupt status of GDMA_IN_ERR_EOF_CH n _INT.
(RO)

GDMA_IN_DSCR_ERR_CH n _INT_ST The masked interrupt status of
GDMA_IN_DSCR_ERR_CH n _INT. (RO)

GDMA_IN_DSCR_EMPTY_CH n _INT_ST The masked interrupt status of
GDMA_IN_DSCR_EMPTY_CH n _INT. (RO)

GDMA_IN_FIFO_OVF_CH n _INT_ST The masked interrupt status of GDMA_IN_FIFO_OVF_CH n _INT.
(RO)

GDMA_IN_FIFO_UDF_CH n _INT_ST The masked interrupt status of GDMA_IN_FIFO_UDF_CH n _INT.
(RO)

Register 4.3. GDMA_IN_INT_ENA_CH n _REG (n : 0-2) (0x0008+0x10* n)

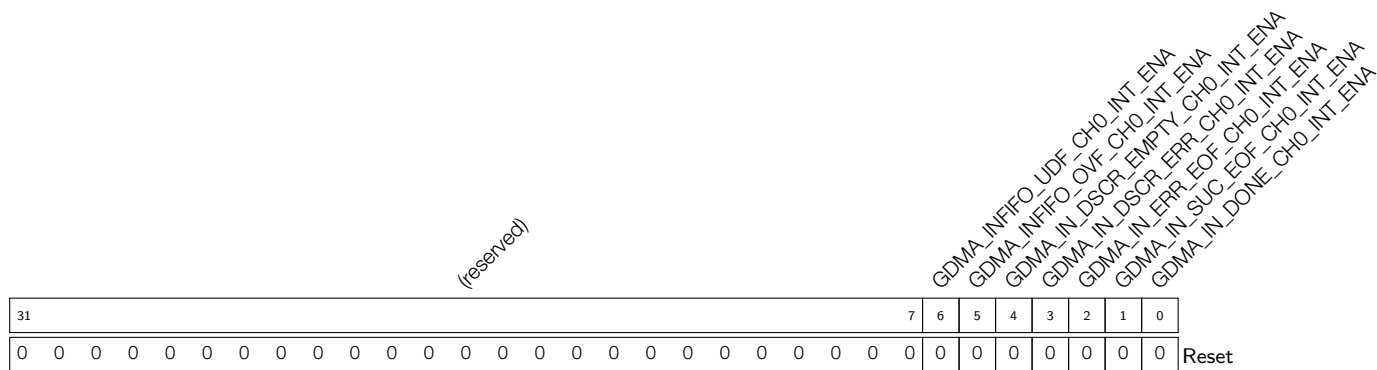

- GDMA_IN_DONE_CH n _INT_ENA** Write 1 to enable GDMA_IN_DONE_CH n _INT. (R/W)
- GDMA_IN_SUC_EOF_CH n _INT_ENA** Write 1 to enable GDMA_IN_SUC_EOF_CH n _INT. (R/W)
- GDMA_IN_ERR_EOF_CH n _INT_ENA** Write 1 to enable GDMA_IN_ERR_EOF_CH n _INT. (R/W)
- GDMA_IN_DSCR_ERR_CH n _INT_ENA** Write 1 to enable GDMA_IN_DSCR_ERR_CH n _INT. (R/W)
- GDMA_IN_DSCR_EMPTY_CH n _INT_ENA** Write 1 to enable GDMA_IN_DSCR_EMPTY_CH n _INT. (R/W)
- GDMA_INFIFO_OVF_CH n _INT_ENA** Write 1 to enable GDMA_INFIFO_OVF_CH n _INT. (R/W)
- GDMA_INFIFO_UDF_CH n _INT_ENA** Write 1 to enable GDMA_INFIFO_UDF_CH n _INT. (R/W)

Register 4.4. GDMA_IN_INT_CLR_CH_n_REG (n : 0-2) (0x000C+0x10* n)

GDMA_INFIFO_UDF_CH0_INT_CLR
 GDMA_INFIFO_OVF_CH0_INT_CLR
 GDMA_IN_DSCR_EMPTY_CH0_INT_CLR
 GDMA_IN_DSCR_ERR_CH0_INT_CLR
 GDMA_IN_ERR_EOF_CH0_INT_CLR
 GDMA_IN_SUC_EOF_CH0_INT_CLR
 GDMA_IN_DONE_CH0_INT_CLR

31	(reserved)							7	6	5	4	3	2	1	0	
0	0	0	0	0	0	0	0	0	0	0	0	0	0	0	0	Reset

GDMA_IN_DONE_CH_n_INT_CLR Write 1 to clear GDMA_IN_DONE_CH_n_INT. (WT)

GDMA_IN_SUC_EOF_CH_n_INT_CLR Write 1 to clear GDMA_IN_SUC_EOF_CH_n_INT. (WT)

GDMA_IN_ERR_EOF_CH_n_INT_CLR Write 1 to clear GDMA_IN_ERR_EOF_CH_n_INT. (WT)

GDMA_IN_DSCR_ERR_CH_n_INT_CLR Write 1 to clear GDMA_IN_DSCR_ERR_CH_n_INT. (WT)

GDMA_IN_DSCR_EMPTY_CH_n_INT_CLR Write 1 to clear GDMA_IN_DSCR_EMPTY_CH_n_INT.
(WT)

GDMA_INFIFO_OVF_CH_n_INT_CLR Write 1 to clear GDMA_INFIFO_OVF_CH_n_INT. (WT)

GDMA_INFIFO_UDF_CH_n_INT_CLR Write 1 to clear GDMA_INFIFO_UDF_CH_n_INT. (WT)

Register 4.5. GDMA_OUT_INT_RAW_CH n _REG (n : 0-2) (0x0030+0x10* n)

(reserved)																						GDMA_OUT_FIFO_UDF_CH0_INT_RAW GDMA_OUT_FIFO_OVF_CH0_INT_RAW GDMA_OUT_TOTAL_EOF_CH0_INT_RAW GDMA_OUT_DSCR_ERR_CH0_INT_RAW GDMA_OUT_DONE_CH0_INT_RAW								
31																							6	5	4	3	2	1	0	Reset
0	0	0	0	0	0	0	0	0	0	0	0	0	0	0	0	0	0	0	0	0	0	0	0	0	0	0	0	0		

GDMA_OUT_DONE_CH n _INT_RAW The raw interrupt status of GDMA_OUT_DONE_CH n _INT. (R/WTC/SS)

GDMA_OUT_EOF_CH n _INT_RAW The raw interrupt status of GDMA_OUT_EOF_CH n _INT. (R/WTC/SS)

GDMA_OUT_DSCR_ERR_CH n _INT_RAW The raw interrupt status of GDMA_OUT_DSCR_ERR_CH n _INT. (R/WTC/SS)

GDMA_OUT_TOTAL_EOF_CH n _INT_RAW The raw interrupt status of GDMA_OUT_TOTAL_EOF_CH n _INT. (R/WTC/SS)

GDMA_OUT_FIFO_OVF_CH n _INT_RAW The raw interrupt status of GDMA_OUT_FIFO_OVF_CH n _INT. (R/WTC/SS)

GDMA_OUT_FIFO_UDF_CH n _INT_RAW The raw interrupt status of GDMA_OUT_FIFO_UDF_CH n _INT. (R/WTC/SS)

Register 4.6. GDMA_OUT_INT_ST_CH n _REG (n : 0-2) (0x0034+0x10* n)

(reserved)

31			6	5	4	3	2	1	0
0 0		0	0	0	0	0	0	0	0

Reset

GDMA_OUTFIFO_UDF_CH0_INT_ST
 GDMA_OUTFIFO_OVF_CH0_INT_ST
 GDMA_OUT_TOTAL_EOF_CH0_INT_ST
 GDMA_OUT_DSCR_ERR_CH0_INT_ST
 GDMA_OUT_EOF_CH0_INT_ST
 GDMA_OUT_DONE_CH0_INT_ST

GDMA_OUT_DONE_CH n _INT_ST The masked interrupt status of GDMA_OUT_DONE_CH n _INT. (RO)

GDMA_OUT_EOF_CH n _INT_ST The masked interrupt status of GDMA_OUT_EOF_CH n _INT. (RO)

GDMA_OUT_DSCR_ERR_CH n _INT_ST The masked interrupt status of GDMA_OUT_DSCR_ERR_CH n _INT. (RO)

GDMA_OUT_TOTAL_EOF_CH n _INT_ST The masked interrupt status of GDMA_OUT_TOTAL_EOF_CH n _INT. (RO)

GDMA_OUTFIFO_OVF_CH n _INT_ST The masked interrupt status of GDMA_OUTFIFO_OVF_CH n _INT. (RO)

GDMA_OUTFIFO_UDF_CH n _INT_ST The masked interrupt status of GDMA_OUTFIFO_UDF_CH n _INT. (RO)

Register 4.8. GDMA_OUT_INT_CLR_CH n _REG (n : 0-2) (0x003C+0x10*n)

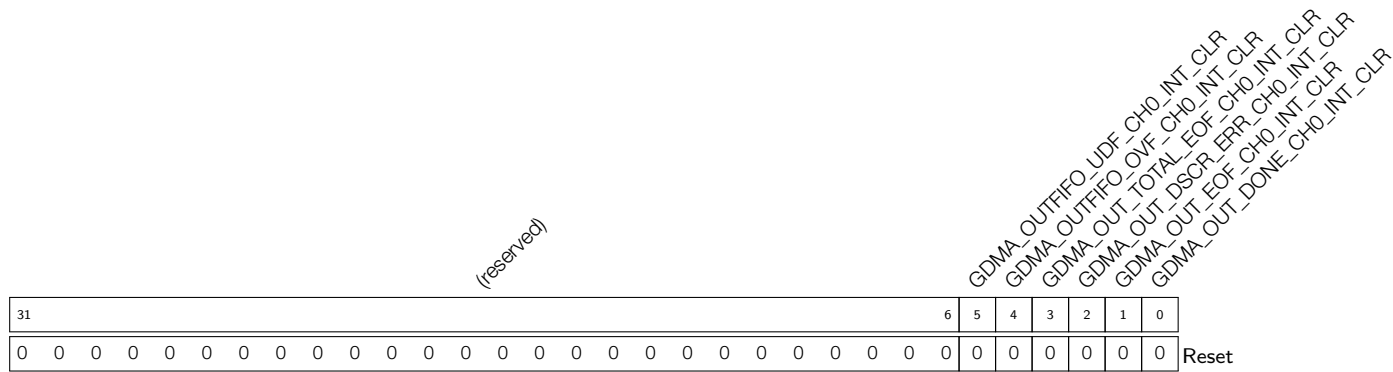

- GDMA_OUT_DONE_CH n _INT_CLR** Write 1 to clear GDMA_OUT_DONE_CH n _INT. (WT)
- GDMA_OUT_EOF_CH n _INT_CLR** Write 1 to clear GDMA_OUT_EOF_CH n _INT. (WT)
- GDMA_OUT_DSCR_ERR_CH n _INT_CLR** Write 1 to clear GDMA_OUT_DSCR_ERR_CH n _INT. (WT)
- GDMA_OUT_TOTAL_EOF_CH n _INT_CLR** Write 1 to clear GDMA_OUT_TOTAL_EOF_CH n _INT. (WT)
- GDMA_OUTFIFO_OVF_CH n _INT_CLR** Write 1 to clear GDMA_OUTFIFO_OVF_CH n _INT. (WT)
- GDMA_OUTFIFO_UDF_CH n _INT_CLR** Write 1 to clear GDMA_OUTFIFO_UDF_CH n _INT. (WT)

Register 4.9. GDMA_AHB_TEST_REG (0x0060)

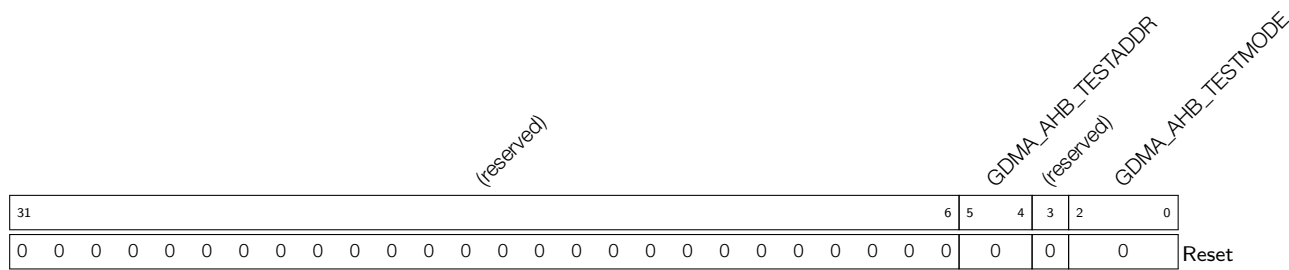

- GDMA_AHB_TESTMODE** Reserved. (R/W)
- GDMA_AHB_TESTADDR** Reserved. (R/W)

Register 4.10. GDMA_MISC_CONF_REG (0x0064)

31	(reserved)										4	3	2	1	0	Reset
0	0	0	0	0	0	0	0	0	0	0	0	0	0	0	0	

GDMA_CLK_EN
GDMA_ARB_PRI_DIS
(reserved)
GDMA_AHBM_RST_INTER

GDMA_AHBM_RST_INTER Write 1 and then 0 to reset the internal AHB FSM. (R/W)

GDMA_ARB_PRI_DIS Configures whether or not to disable the fixed-priority channel arbitration.

0: Enable

1: Disable

(R/W)

GDMA_CLK_EN Configures clock gating.

0: Support clock only when the application writes registers.

1: Always force the clock on for registers.

(R/W)

Register 4.11. GDMA_IN_CONF0_CHn_REG (n: 0-2) (0x0070+0xC0*n)

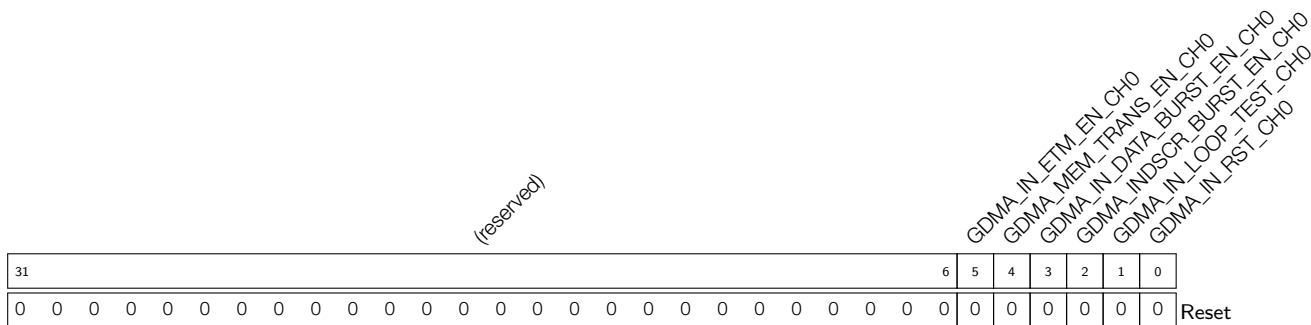

GDMA_IN_RST_CHn Write 1 and then 0 to reset GDMA channel 0 RX FSM and RX FIFO pointer. (R/W)

GDMA_IN_LOOP_TEST_CHn Reserved. (R/W)

GDMA_INDSCR_BURST_EN_CHn Configures whether or not to enable INCR burst transfer for RX channel *n* to read descriptors.
 0: Disable
 1: Enable
 (R/W)

GDMA_IN_DATA_BURST_EN_CHn Configures whether or not to enable INCR burst transfer for RX channel *n*.
 0: Disable
 1: Enable
 (R/W)

GDMA_MEM_TRANS_EN_CHn Configures whether or not to enable memory-to-memory data transfer.
 0: Disable
 1: Enable
 (R/W)

GDMA_IN_ETM_EN_CHn Configures whether or not to enable ETM control for RX channel *n*.
 0: Disable
 1: Enable
 (R/W)

Register 4.12. GDMA_IN_CONF1_CHn_REG (n: 0-2) (0x0074+0xC0*n)

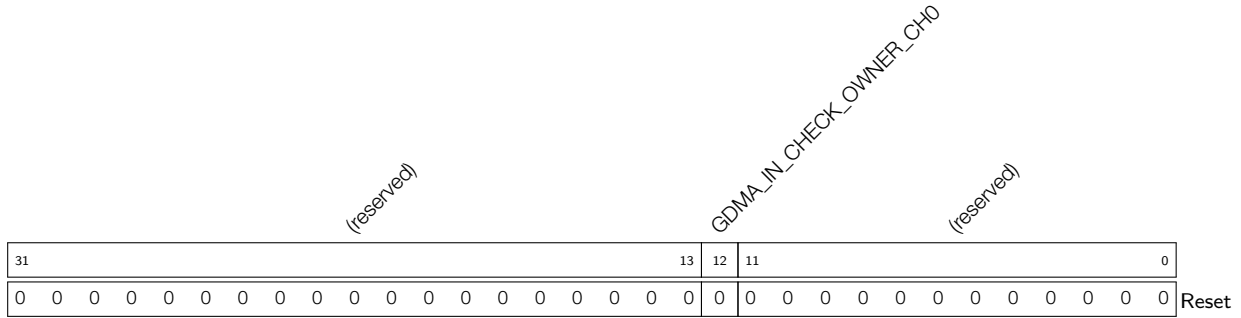

GDMA_IN_CHECK_OWNER_CHn Configures whether or not to enable owner bit check for RX channel *n*.

- 0: Disable
 - 1: Enable
- (R/W)

Register 4.13. GDMA_IN_POP_CHn_REG (n: 0-2) (0x007C+0xC0*n)

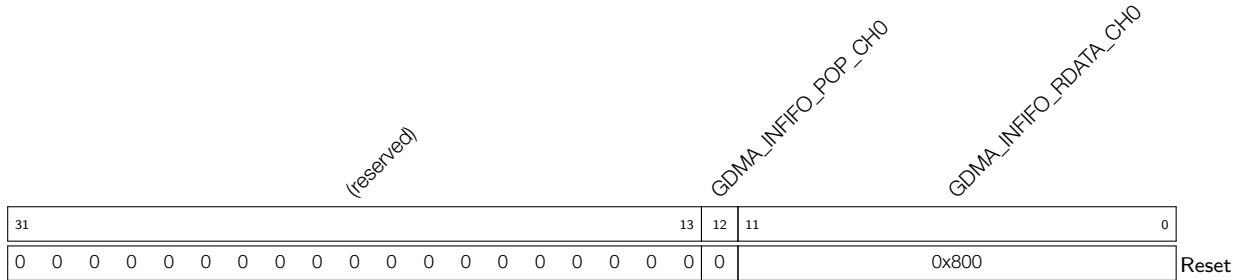

GDMA_INFIFO_RDATA_CHn Represents the data popped from GDMA FIFO. (RO)

GDMA_INFIFO_POP_CHn Configures whether to pop data from GDMA FIFO.

- 0: Invalid. No effect
 - 1: Pop
- (WT)

Register 4.14. GDMA_INLINK_CH n _REG (n : 0-2) (0x0080+0xC0* n)

(reserved)							GDMA_INLINK_PARK_CH0 GDMA_INLINK_RESTART_CH0 GDMA_INLINK_START_CH0 GDMA_INLINK_STOP_CH0 GDMA_INLINK_AUTO_RET_CH0					GDMA_INLINK_ADDR_CH0											
31						25	24	23	22	21	20	19											0
0 0 0 0 0 0 0							1	0	0	0	1	0x000										Reset	

GDMA_INLINK_ADDR_CH n Represents the lower 20 bits of the first receive descriptor's address.
(R/W)

GDMA_INLINK_AUTO_RET_CH n Configures whether or not to return to the current receive descriptor's address when there are some errors in current receiving data.
0: Not return
1: Return
(R/W)

GDMA_INLINK_STOP_CH n Configures whether to stop GDMA's RX channel n from receiving data.
0: Invalid. No effect
1: Stop
(WT)

GDMA_INLINK_START_CH n Configures whether or not to enable GDMA's RX channel n for data transfer.
0: Disable
1: Enable
(WT)

GDMA_INLINK_RESTART_CH n Configures whether to restart RX channel n for GDMA transfer.
0: Invalid. No effect
1: Restart
(WT)

GDMA_INLINK_PARK_CH n Represents the status of the receive descriptor's FSM.
0: Running
1: Idle
(RO)

Register 4.15. GDMA_OUT_CONF0_CH n _REG (n : 0-2) (0x00D0+0xC0* n)

(reserved)														<div style="display: flex; justify-content: space-between;"> GDMA_OUT_ETM_EN_CHn GDMA_OUT_DATA_BURST_EN_CHn GDMA_OUTDSCR_BURST_EN_CHn GDMA_OUT_EOF_MODE_CHn GDMA_OUT_AUTO_WRBACK_CHn GDMA_OUT_LOOP_TEST_CHn GDMA_OUT_RST_CHn </div>								
31													7	6	5	4	3	2	1	0		
0	0	0	0	0	0	0	0	0	0	0	0	0	0	0	0	0	0	1	0	0	0	Reset

GDMA_OUT_RST_CH n Configures the reset state of GDMA channel n TX FSM and TX FIFO pointer.

- 0: Release reset
 - 1: Reset
- (R/W)

GDMA_OUT_LOOP_TEST_CH n Reserved. (R/W)

GDMA_OUT_AUTO_WRBACK_CH n Configures whether or not to enable automatic outlink write-back when all the data in TX FIFO has been transmitted.

- 0: Disable
 - 1: Enable
- (R/W)

GDMA_OUT_EOF_MODE_CH n Configures when to generate EOF flag.

- 0: EOF flag for TX channel n is generated when data to be transmitted has been pushed into FIFO in GDMA.
 - 1: EOF flag for TX channel n is generated when data to be transmitted has been popped from FIFO in GDMA.
- (R/W)

GDMA_OUTDSCR_BURST_EN_CH n Configures whether or not to enable INCR burst transfer for TX channel n reading descriptors.

- 0: Disable
 - 1: Enable
- (R/W)

GDMA_OUT_DATA_BURST_EN_CH n Configures whether or not to enable INCR burst transfer for TX channel n .

- 0: Disable
 - 1: Enable
- (R/W)

GDMA_OUT_ETM_EN_CH n Configures whether or not to enable ETM control for TX channel n .

- 0: Disable
 - 1: Enable
- (R/W)

Register 4.16. GDMA_OUT_CONF1_CH n _REG (n : 0-2) (0x00D4+0xC0* n)

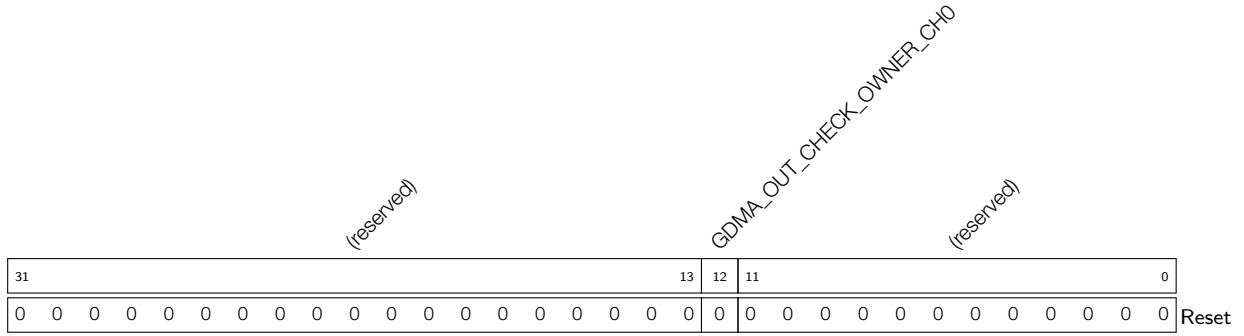

GDMA_OUT_CHECK_OWNER_CH n Configures whether or not to enable owner bit check for TX channel n .
 0: Disable
 1: Enable
 (R/W)

Register 4.17. GDMA_OUT_PUSH_CH n _REG (n : 0-2) (0x00DC+0xC0* n)

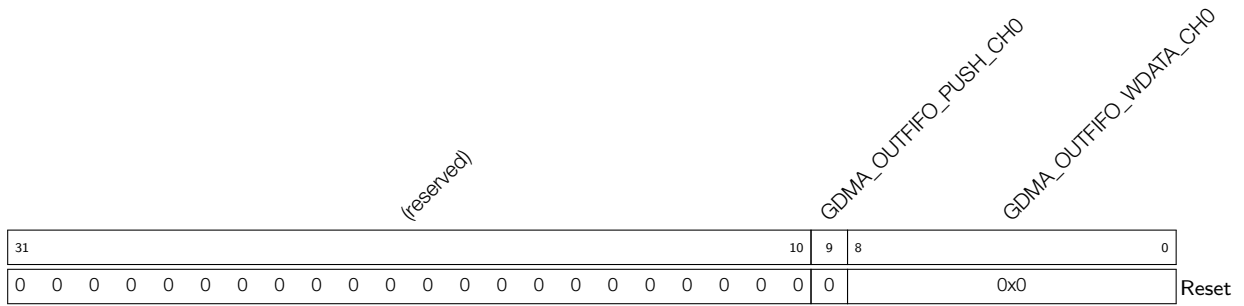

GDMA_OUTFIFO_WDATA_CH n Represents the data that need to be pushed into GDMA FIFO. (R/W)

GDMA_OUTFIFO_PUSH_CH n Configures whether to push data into GDMA FIFO.
 0: Invalid. No effect
 1: Push
 (WT)

Register 4.18. GDMA_OUT_LINK_CH n _REG (n : 0-2) (0x00E0+0xC0* n)

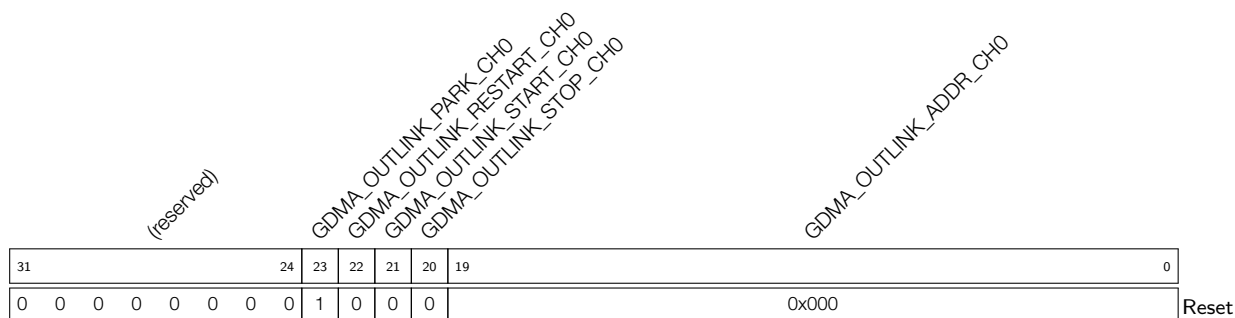

GDMA_OUTLINK_ADDR_CH n Represents the lower 20 bits of the first transmit descriptor's address.
(R/W)

GDMA_OUTLINK_STOP_CH n Configures whether to stop GDMA's TX channel n from transmitting data.
0: Invalid. No effect
1: Stop
(WT)

GDMA_OUTLINK_START_CH n Configures whether to enable GDMA's TX channel n for data transfer.
0: Disable
1: Enable
(WT)

GDMA_OUTLINK_RESTART_CH n Configures whether to restart TX channel n for GDMA transfer.
0: Invalid. No effect
1: Restart
(WT)

GDMA_OUTLINK_PARK_CH n Represents the status of the transmit descriptor's FSM.
0: Running
1: Idle
(RO)

Register 4.19. GDMA_DATE_REG (0x0068)

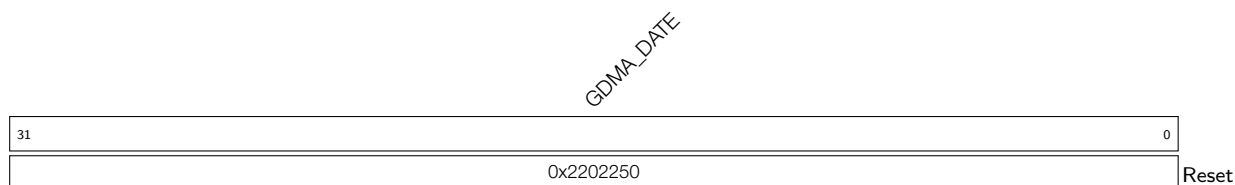

GDMA_DATE Version control register. (R/W)

Register 4.21. GDMA_IN_STATE_CH n _REG (n : 0-2) (0x0084+0xC0* n)

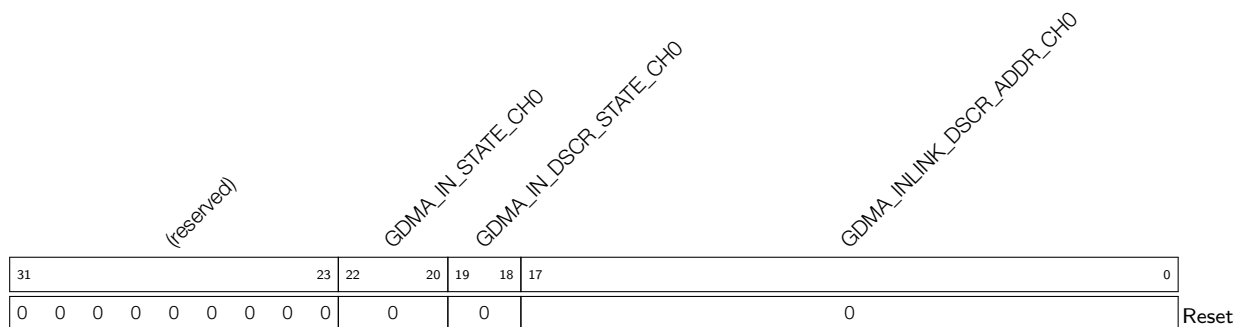

GDMA_INLINK_DSCR_ADDR_CH n Represents the lower 18 bits of the next receive descriptor address that is pre-read (but not processed yet). If the current receive descriptor is the last descriptor, then this field represents the address of the current receive descriptor. (RO)

GDMA_IN_DSCR_STATE_CH n Reserved. (RO)

GDMA_IN_STATE_CH n Reserved. (RO)

Register 4.22. GDMA_IN_SUC_EOF_DES_ADDR_CH n _REG (n : 0-2) (0x0088+0xC0* n)

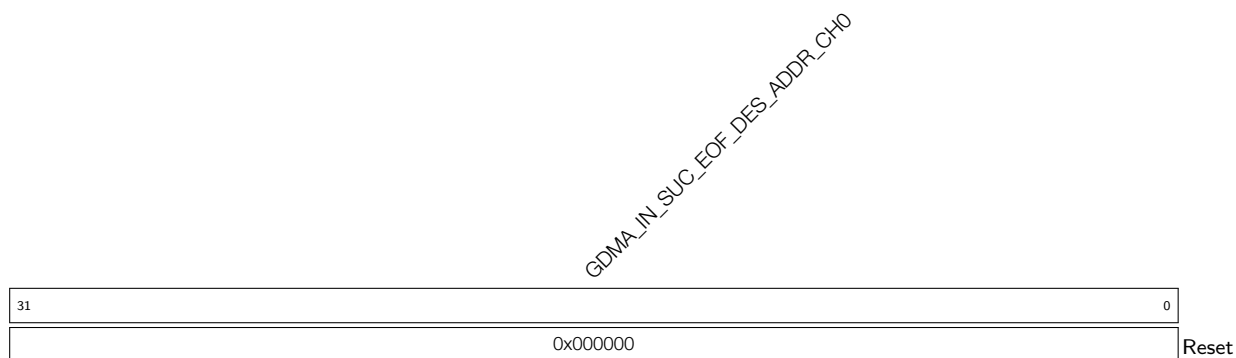

GDMA_IN_SUC_EOF_DES_ADDR_CH n Represents the address of the receive descriptor when the EOF bit in this descriptor is 1. (RO)

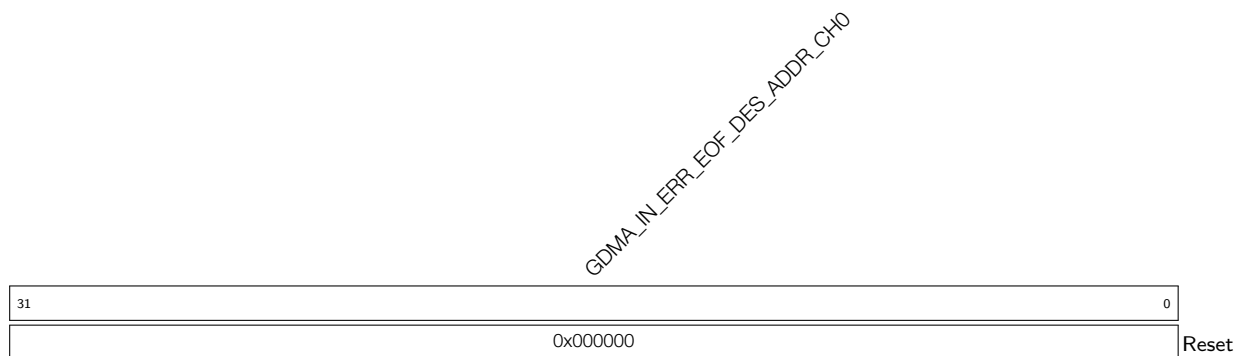
Register 4.23. GDMA_IN_ERR_EOF_DES_ADDR_CH n _REG (n : 0-2) (0x008C+0xC0* n)

GDMA_IN_ERR_EOF_DES_ADDR_CH n Represents the address of the receive descriptor when there are some errors in the currently received data. Valid only for UHCI or PARLIO. (RO)

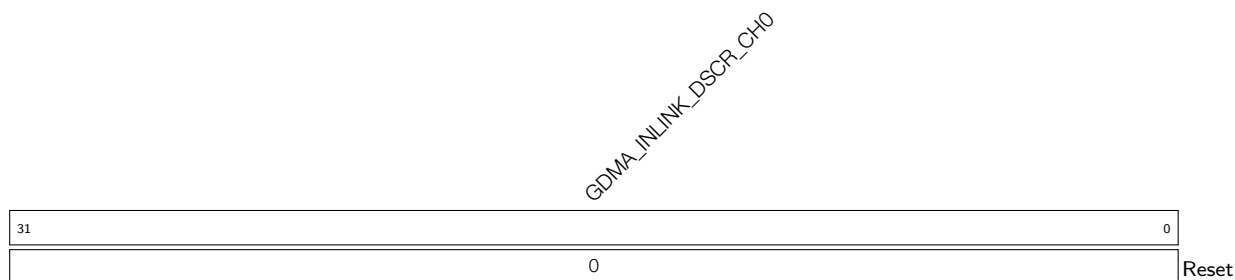
Register 4.24. GDMA_IN_DSCR_CH n _REG (n : 0-2) (0x0090+0xC0* n)

GDMA_INLINK_DSCR_CH n Represents the address of the next receive descriptor x+1 pointed by the current receive descriptor that is pre-read. (RO)

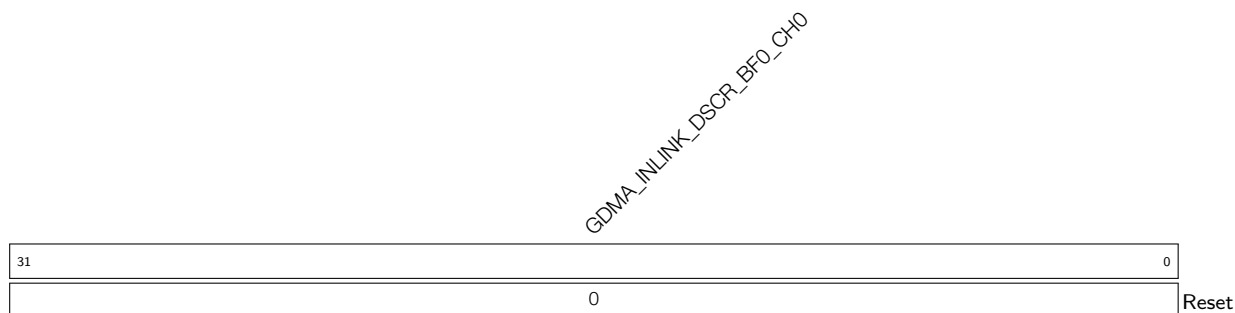
Register 4.25. GDMA_IN_DSCR_BF0_CH n _REG (n : 0-2) (0x0094+0xC0* n)

GDMA_INLINK_DSCR_BF0_CH n Represents the address of the current receive descriptor x that is pre-read. (RO)

Register 4.28. GDMA_OUT_STATE_CH n _REG (n : 0-2) (0x00E4+0xC0* n)

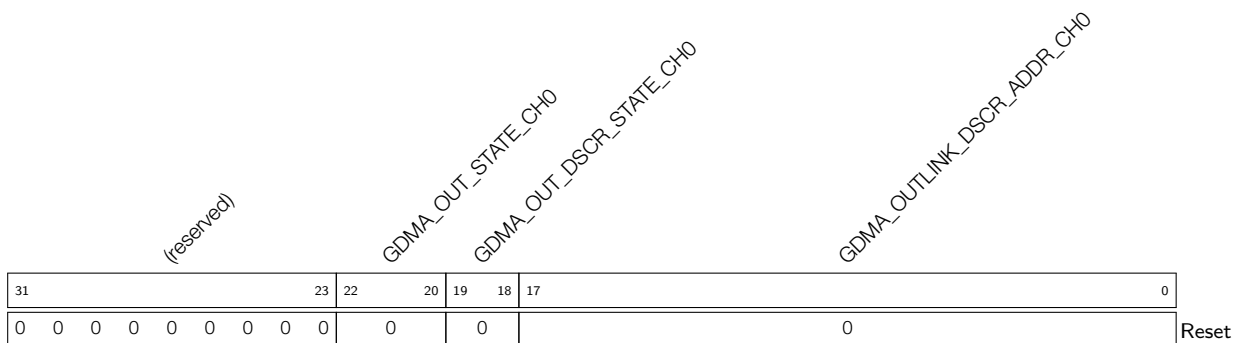

GDMA_OUTLINK_DSCR_ADDR_CH n Represents the lower 18 bits of the next transmit descriptor address that is pre-read (but not processed yet). If the current transmit descriptor is the last descriptor, then this field represents the address of the current transmit descriptor. (RO)

GDMA_OUT_DSCR_STATE_CH n Reserved. (RO)

GDMA_OUT_STATE_CH n Reserved. (RO)

Register 4.29. GDMA_OUT_EOF_DES_ADDR_CH n _REG (n : 0-2) (0x00E8+0xC0* n)

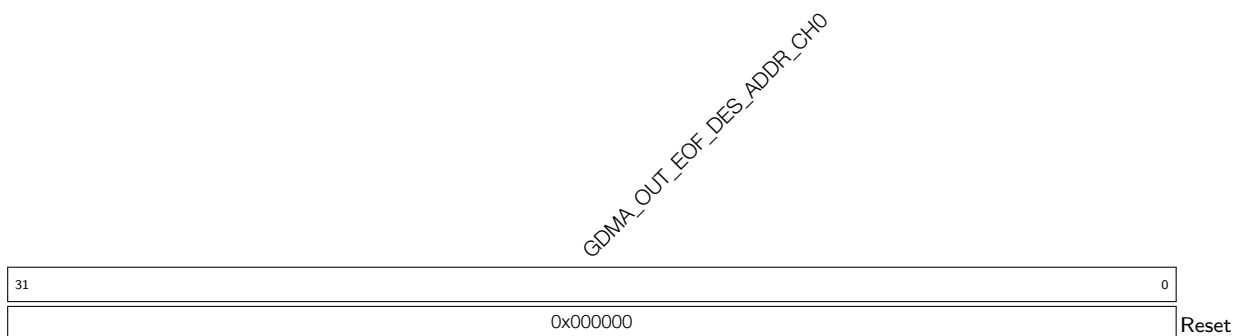

GDMA_OUT_EOF_DES_ADDR_CH n Represents the address of the transmit descriptor when the EOF bit in this descriptor is 1. (RO)

Register 4.30. GDMA_OUT_EOF_BFR_DES_ADDR_CH n _REG (n : 0-2) (0x00EC+0xC0* n)

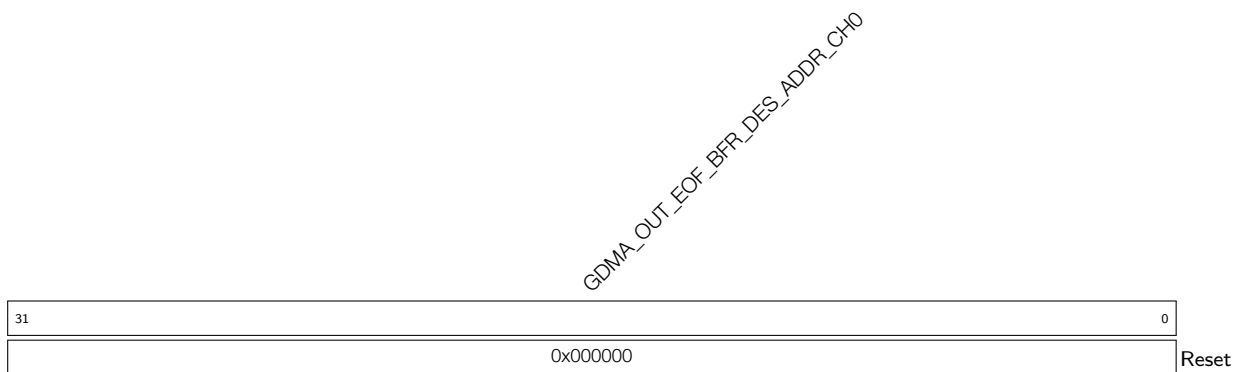

GDMA_OUT_EOF_BFR_DES_ADDR_CH n Represents the address of the transmit descriptor before the last transmit descriptor. (RO)

Register 4.31. GDMA_OUT_DSCR_CH n _REG (n : 0-2) (0x00F0+0xC0* n)

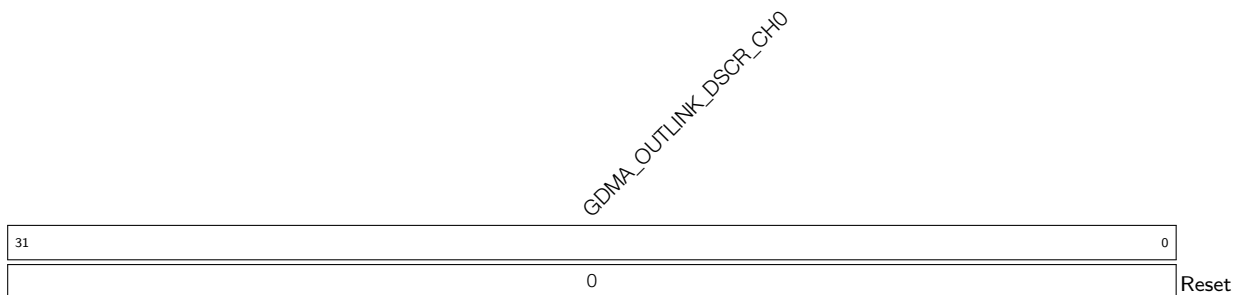

GDMA_OUTLINK_DSCR_CH n Represents the address of the next transmit descriptor y+1 pointed by the current transmit descriptor that is pre-read. (RO)

Register 4.32. GDMA_OUT_DSCR_BF0_CH n _REG (n : 0-2) (0x00F4+0xC0* n)

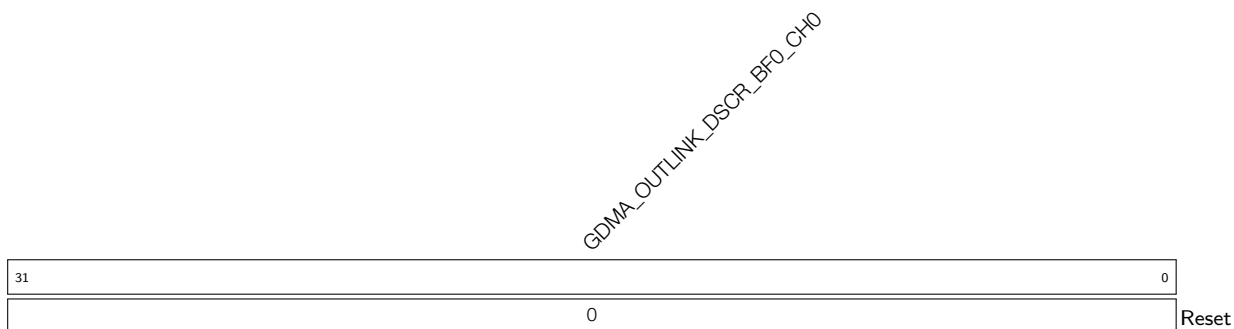

GDMA_OUTLINK_DSCR_BF0_CH n Represents the address of the current transmit descriptor y that is pre-read. (RO)

Register 4.33. GDMA_OUT_DSCR_BF1_CH n _REG (n : 0-2) (0x00F8+0xC0* n)

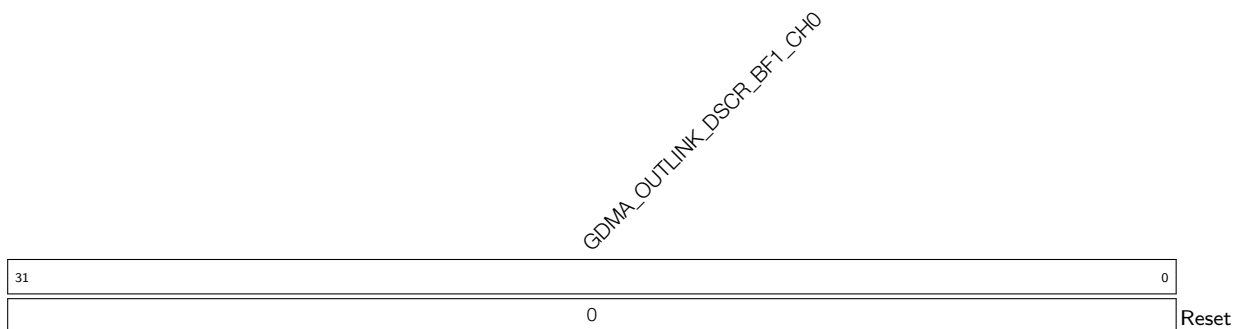

GDMA_OUTLINK_DSCR_BF1_CH n Represents the address of the previous transmit descriptor y-1 that is pre-read. (RO)

Register 4.34. GDMA_IN_PRI_CH n _REG (n : 0-2) (0x009C+0xC0* n)

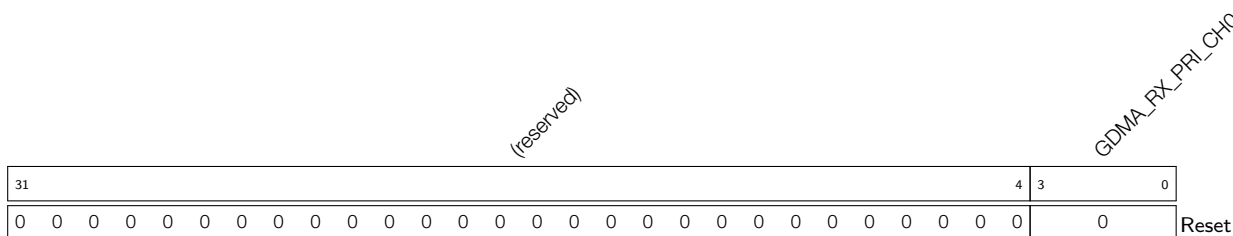

GDMA_RX_PRI_CH n Configures the priority of RX channel n .
 Value range: 0 ~ 9
 The larger of the value, the higher of the priority. (R/W)

Register 4.35. GDMA_OUT_PRI_CH n _REG (n : 0-2) (0x00FC+0xC0* n)

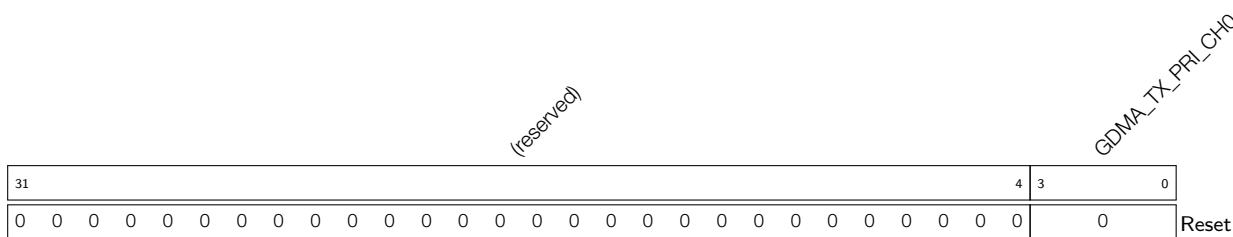

GDMA_TX_PRI_CH n Configures the priority of TX channel n .
 Value range: 0 ~ 9
 The larger of the value, the higher of the priority. (R/W)

Register 4.37. GDMA_OUT_PERI_SEL_CH n _REG (n : 0-2) (0x0100+0xC0* n)

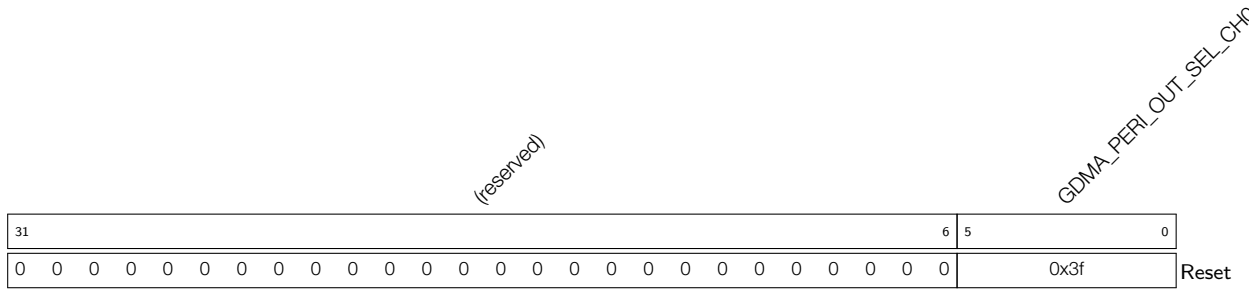

GDMA_PERI_OUT_SEL_CH n Configures the peripheral connected to TX channel n .

- 0: SPI2
 - 1: Dummy-1
 - 2: UHCI
 - 3: I2S0
 - 4: Dummy-4
 - 5: Dummy-5
 - 6: AES
 - 7: SHA
 - 8: ADC
 - 9: Parallel IO
 - 10 ~ 15: Dummy-10 ~ 15
 - 16 ~ 63: Invalid.
- (R/W)

5 System and Memory

5.1 Overview

ESP32-C6 is an ultra-low power and highly-integrated system that integrates:

- a high-performance 32-bit RISC-V single-core processor (HP CPU), four-stage pipeline, clock frequency up to 160 MHz
- a low-power 32-bit RISC-V single-core processor (LP CPU), two-stage pipeline, clock frequency up to 20 MHz

All internal memory, external memory, and peripherals are located on the HP CPU and LP CPU buses.

5.2 Features

- **Address Space**
 - 832 KB of internal memory address space accessed from the instruction bus or data bus
 - 832 KB of peripheral address space
 - 16 MB of external memory virtual address space accessed from the instruction bus or the data bus
 - 512 KB of internal DMA address space
- **Internal Memory**
 - 320 KB internal ROM
 - 512 KB HP SRAM
 - 16 KB LP SRAM
- **External Memory**
 - Supports up to 16 MB external flash
- **Peripheral Space**
 - 52 modules/peripherals in total
- **GDMA**
 - 8 GDMA-supported modules/peripherals

Figure 5-1 illustrates the system structure and address mapping.

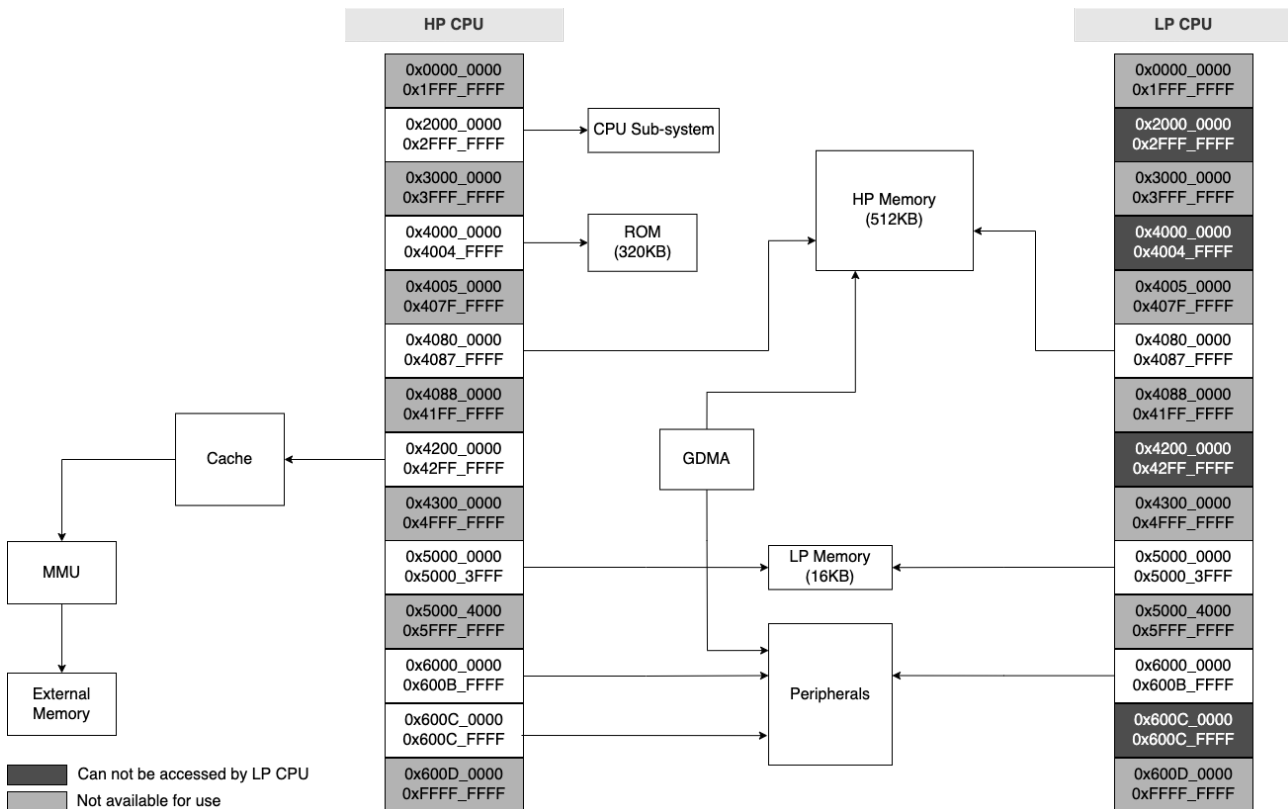

Figure 5-1. System Structure and Address Mapping

Note:

- The range of addresses available in the address space may be larger than the actual available memory of a particular type.
- For CPU Sub-system, please refer to Chapter 1 *High-Performance CPU*.

5.3 Functional Description

5.3.1 Address Mapping

All the non-reserved addresses are accessible by the instruction bus and the data bus, that is, the instruction bus and the data bus access the same address space.

Both data bus and instruction bus of the HP CPU and LP CPU are little-endian. The HP CPU and LP CPU can access data via the data bus using single-byte, double-byte, and 4-byte alignment.

The CPU can:

- directly access the internal memory via both data bus and instruction bus.
- (for HP CPU only) directly access the external memory which is mapped into the address space via cache.
- directly access modules/peripherals via data bus.

Table 5-1 lists the address ranges on the data bus and instruction bus and their corresponding target memories.

Table 5-1. Memory Address Mapping

Bus Type	Boundary Address		Size	Target
	Low Address	High Address		
	0x0000_0000	0x3FFF_FFFF		Reserved
Data/Instruction bus	0x4000_0000	0x4004_FFFF	320 KB	ROM*
	0x4005_0000	0x407F_FFFF		Reserved
Data/Instruction bus	0x4080_0000	0x4087_FFFF	512 KB	HP SRAM*
	0x4088_0000	0x41FF_FFFF		Reserved
Data/Instruction bus	0x4200_0000	0x42FF_FFFF	16 MB	External memory
	0x4300_0000	0x4FFF_FFFF		Reserved
Data/Instruction bus	0x5000_0000	0x5000_3FFF	16 KB	LP SRAM*
	0x5000_4000	0x5FFF_FFFF		Reserved
Data/Instruction bus	0x6000_0000	0x600C_FFFF	832 KB	Peripherals
	0x600D_0000	0xFFFF_FFFF		Reserved

* All of the internal memories are managed by Permission Control module. An internal memory can only be accessed when it is allowed by Permission Control, then the internal memory can be available to the HP CPU and LP CPU. For more information about Permission Control, please refer to Chapter [15 Permission Control \(PMS\)](#).

5.3.2 Internal Memory

ESP32-C6 consists of the following three types of internal memory:

- ROM (320 KB): The ROM is a read-only memory and can not be programmed. It contains the ROM code of some low-level system software and read-only data.
- HP SRAM (512 KB): The HP SRAM is a volatile memory that can be quickly accessed by the HP CPU or LP CPU (generally within a single HP CPU clock cycle for HP CPU).
- LP SRAM (16 KB): LP SRAM is also a volatile memory, however, in Deep-sleep mode, data stored in the LP SRAM will not be lost. The LP SRAM can be accessed by the HP CPU or LP CPU and is usually used to store program instructions and data that need to be kept in sleep mode.

1. ROM

This 320 KB ROM is a read-only memory, addressed by the HP CPU through the instruction bus or through the data bus via 0x4000_0000 ~ 0x4004_FFFF in the same order, as shown in Table 5-1.

This means, for example, address 0x4004_0000 can be accessed by the instruction bus or the data bus.

2. HP SRAM

This 512 KB HP SRAM is a read-and-write memory, accessed by the HP CPU or LP CPU through the instruction bus or through the data bus in the same order as shown in Table 5-1.

3. LP SRAM

This 16 KB LP SRAM is a read-and-write memory, accessed by the HP CPU or LP CPU through the instruction bus or through the data bus via their shared address 0x5000_0000 ~ 0x5000_3FFF as shown in Table 5-1.

LP SRAM can be accessed by the following modes:

- high-speed mode, i.e., the LP SRAM is accessed in HP CPU clock frequency. In this case:
 - HP CPU can access the LP SRAM without any latency.
 - But the latency of LP CPU accessing LP SRAM ranges from a few dozen to dozens of LP CPU cycles.
- low-speed mode, i.e., the LP SRAM is accessed in LP CPU clock frequency. In this case:
 - LP CPU can access the LP SRAM with zero cycle latency.
 - But the latency of HP CPU accessing LP SRAM ranges from a few dozen to dozens of HP CPU cycles.

You can switch the modes based on your application scenarios.

- If the LP CPU is not working, you can switch to high-speed mode to improve the access speed of the HP CPU.
- If the LP CPU is executing code in the LP SRAM, you can switch to the low-speed mode.

When the HP CPU is in sleep mode, you must switch to the low-speed mode.

Detailed configuration is as follows:

- Configure [LP_AON_FAST_MEM_MUX_SEL](#) to select the mode needed:
 - 1: high-speed mode
 - 0: low-speed mode
- Set [LP_AON_FAST_MEM_MUX_SEL_UPDATE](#) to start mode switch.
- Read [LP_AON_FAST_MEM_MUX_SEL_STATUS](#) to check if mode switch is done:
 - 0: mode is switched
 - 1: mode is not switched

5.3.3 External Memory

ESP32-C6 supports SPI, Dual SPI, Quad SPI, and QPI interfaces that allow connection to external flash. ESP32-C6 also supports hardware manual encryption and automatic decryption based on XTS-AES algorithm to protect users' programs and data in the external flash.

5.3.3.1 External Memory Address Mapping

The HP CPU accesses the external memory via the cache. According to information inside the MMU (Memory Management Unit), the cache maps the HP CPU's address (0x4200_0000 ~ 0x42FF_FFFF) into a physical address of the external memory. Due to this address mapping, ESP32-C6 can address up to 16 MB external flash. Note that the instruction bus shares the same address space (16 MB) with the data bus to access the external memory.

5.3.3.2 Cache

As shown in Figure 5-2, ESP32-C6 has a read-only uniform cache which is four-way set-associative. Its size is 32 KB and its block size is 32 bytes. The cache is accessible by the instruction bus and the data bus at the same time, but can only respond to one of them at a time. When a cache miss occurs, the cache controller will initiate a request to the external memory.

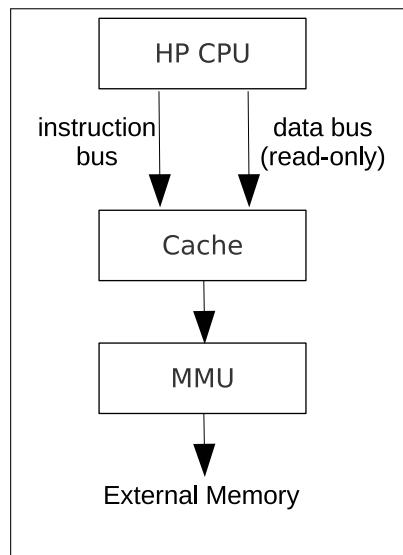

Figure 5-2. Cache Structure

5.3.3.3 Cache Operations

ESP32-C6 cache supports the following operations:

1. **Invalidate:** This operation is used to remove valid data in the cache. Once this operation is done, the deleted data is stored only in the external memory. If the HP CPU wants to access the data again, it needs to access the external memory. There are two types of invalidate operation: Invalidate-All and Manual-Invalidate. Manual-Invalidate is performed only on data in the specified area in the cache, while Invalidate-All is performed on all data in the cache.
2. **Preload:** This operation is to load instructions and data into the cache in advance. The minimum unit of preload-operation is one block. There are two types of preload-operation: manual preload (Manual-Preload) and automatic preload (Auto-Preload). Manual-Preload means that the hardware prefetches a piece of continuous data according to the virtual address specified by the software. Auto-Preload means the hardware prefetches a piece of continuous data according to the current address where the cache hits or misses (depending on configuration).
3. **Lock/Unlock:** The lock operation is used to prevent the data in the cache from being easily replaced. There are two types of lock: prelock and manual lock. When prelock is enabled, the cache locks the data in the specified area when filling the missing data to cache memory, while the data outside the specified area will not be locked. When manual lock is enabled, the cache checks the data that is already in the cache memory and locks the data only if it falls in the specified area, and leaves the data outside the specified area unlocked. When there are missing data, the cache will replace the data in the unlocked way first, so the data in the locked way is always stored in the cache and will not be replaced. But when all ways within the cache are locked, the cache will replace data, as if it was not locked. Unlocking is the reverse of locking, except that it only can be done manually.

Please note that Invalidate-All operation only works on the unlocked data. If you expect to perform such operation on the locked data, please unlock them first.

5.3.4 GDMA Address Space

The General Direct Memory Access (GDMA) peripheral consisting of three TX channels and three RX channels provides Direct Memory Access (DMA) service, including:

- data transfers between different locations of internal memory
- data transfers between modules/peripherals and internal memory

GDMA uses the same addresses as the data bus to access HP SRAM, i.e., GDMA uses address range 0x4080_0000 ~ 0x4087_FFFF to access HP SRAM.

Eight modules/peripherals in ESP32-C6 work together with GDMA. As shown in Figure 5-3, eight vertical lines correspond to these eight modules/peripherals with GDMA function. The horizontal line represents a certain channel of GDMA (can be any channel), and the intersection of the vertical line and the horizontal line indicates that a module/peripheral has the ability to access the corresponding channel of GDMA. If there are multiple intersections on the same line, it means that these peripherals/modules can not enable the GDMA function at the same time.

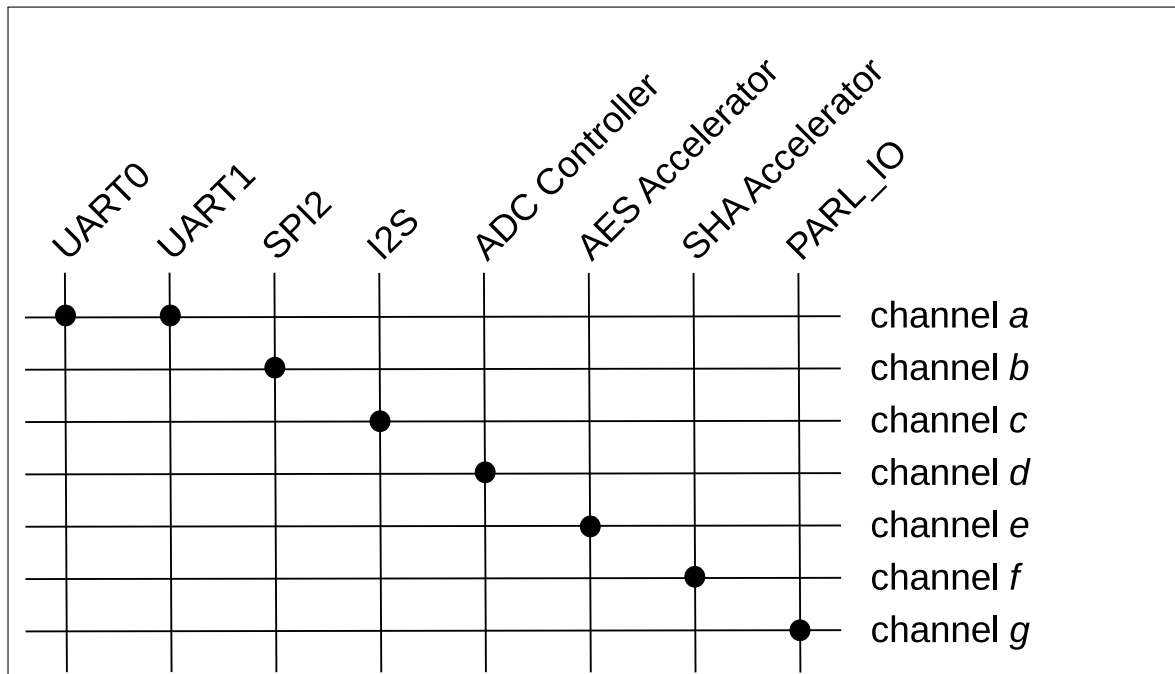

Figure 5-3. Modules/peripherals that can work with GDMA

These modules/peripherals can access any memory available to GDMA. For more information, please refer to Chapter 4 *GDMA Controller (GDMA)*.

Note:

When accessing a memory via GDMA, a corresponding access permission is needed, otherwise this access may fail. For more information about permission control, please refer to Chapter 15 *Permission Control (PMS)*.

5.3.5 Modules/Peripherals Address Mapping

Table 5-2 lists all the modules/peripherals and their respective address ranges. Note that the address space of specific modules/peripherals is defined by “Boundary Address” (including both Low Address and High Address).

Table 5-2. Module/Peripheral Address Mapping

Target	Boundary Address		Size (KB)
	Low Address	High Address	
UART Controller 0 (UART0)	0x6000_0000	0x6000_0FFF	4
UART Controller 1 (UART1)	0x6000_1000	0x6000_1FFF	4
SPI Controller 0 (SPI0)	0x6000_2000	0x6000_2FFF	4
SPI Controller 1 (SPI1)	0x6000_3000	0x6000_3FFF	4
I2C Controller (I2C)	0x6000_4000	0x6000_4FFF	4
UHCI Controller (UHCI)	0x6000_5000	0x6000_5FFF	4
Remote Control Peripheral (RMT)	0x6000_6000	0x6000_6FFF	4
LED PWM Controller (LEDC)	0x6000_7000	0x6000_7FFF	4
Timer Group 0 (TIMG0)	0x6000_8000	0x6000_8FFF	4
Timer Group 1 (TIMG1)	0x6000_9000	0x6000_9FFF	4
System Timer (SYSTIMER)	0x6000_A000	0x6000_AFFF	4
Two-wire Automotive Interface 0 (TWA0)	0x6000_B000	0x6000_BFFF	4
I2S Controller (I2S)	0x6000_C000	0x6000_CFFF	4
Two-wire Automotive Interface 1 (TWA1)	0x6000_D000	0x6000_DFFF	4
Successive Approximation ADC (SAR ADC)	0x6000_E000	0x6000_EFFF	4
USB Serial/JTAG Controller	0x6000_F000	0x6000_FFFF	4
Interrupt Matrix (INTMTX)	0x6001_0000	0x6001_0FFF	4
Reserved	0x6001_1000	0x6001_1FFF	
Pulse Count Controller (PCNT)	0x6001_2000	0x6001_2FFF	4
Event Task Matrix (SOC_ETM)	0x6001_3000	0x6001_3FFF	4
Motor Control PWM (MCPWM)	0x6001_4000	0x6001_4FFF	4
Parallel IO Controller (PARL_IO)	0x6001_5000	0x6001_5FFF	4
SDIO HINF*	0x6001_6000	0x6001_6FFF	4
SDIO SLC*	0x6001_7000	0x6001_7FFF	4
SDIO SLCHOST*	0x6001_8000	0x6001_8FFF	4
Reserved	0x6001_9000	0x6007_FFFF	
GDMA Controller (GDMA)	0x6008_0000	0x6008_0FFF	4
General Purpose SPI2 (GP-SPI2)	0x6008_1000	0x6008_1FFF	4
Reserved	0x6008_2000	0x6008_7FFF	
AES Accelerator (AES)	0x6008_8000	0x6008_8FFF	4
SHA Accelerator (SHA)	0x6008_9000	0x6008_9FFF	4
RSA Accelerator (RSA)	0x6008_A000	0x6008_AFFF	4
ECC Accelerator (ECC)	0x6008_B000	0x6008_BFFF	4
Digital Signature (DS)	0x6008_C000	0x6008_CFFF	4
HMAC Accelerator (HMAC)	0x6008_D000	0x6008_DFFF	4
Reserved	0x6008_E000	0x6008_FFFF	
IO MUX	0x6009_0000	0x6009_0FFF	4
GPIO Matrix	0x6009_1000	0x6009_1FFF	4
Memory Assess Monitor (MEM_MONITOR)*	0x6009_2000	0x6009_2FFF	4

Cont'd on next page

Table 5-2 – cont'd from previous page

Target	Boundary Address		Size (KB)
	Low Address	High Address	
Reserved	0x6009_4000	0x6009_4FFF	
HP System Register (HP_SYSREG)	0x6009_5000	0x6009_5FFF	4
Power/Clock/Reset (PCR) Register	0x6009_6000	0x6009_6FFF	4
Reserved	0x6009_7000	0x6009_7FFF	
Trusted Execution Environment (TEE) Register*	0x6009_8000	0x6009_8FFF	4
Access Permission Management Controller (HP_APM)*	0x6009_9000	0x6009_9FFF	4
Reserved	0x6009_A000	0x600A_FFFF	
Power Management Unit (PMU)	0x600B_0000	0x600B_03FF	1
Low-power Clock/Reset Register (LP_CLKRST)	0x600B_0400	0x600B_07FF	1
eFuse Controller (EFUSE)	0x600B_0800	0x600B_0BFF	1
Low-power Timer (LP_TIMER)	0x600B_0C00	0x600B_0FFF	1
Low-power Always-on Register (LP_AON)	0x600B_1000	0x600B_13FF	1
Low-power UART (LP_UART)	0x600B_1400	0x600B_17FF	1
Low-power I2C (LP_I2C)	0x600B_1800	0x600B_1BFF	1
Low-power Watch Dog Timer (LP_WDT)	0x600B_1C00	0x600B_1FFF	1
Low-power IO MUX (LP IO MUX)	0x600B_2000	0x600B_23FF	1
I2C Analog Master (I2C_ANA_MST)	0x600B_2400	0x600B_27FF	1
Low-power Peripheral (LPPERI)	0x600B_2800	0x600B_2BFF	1
Low-power Analog Peripheral (LP_ANA_PERI)	0x600B_2C00	0x600B_2FFF	1
Reserved	0x600B_3000	0x600B_33FF	
Low-power Trusted Execution Environment (LP_TEE)*	0x600B_3400	0x600B_37FF	1
Low-power Access Permission Management (LP_APM)*	0x600B_3800	0x600B_3BFF	1
Reserved	0x600B_3C00	0x600B_FFFF	
RISC-V Trace Encoder (TRACE)	0x600C_0000	0x600C_0FFF	4
Reserved	0x600C_1000	0x600C_1FFF	
DEBUG ASSIST (ASSIST_DEBUG)*	0x600C_2000	0x600C_2FFF	4
Reserved	0x600C_3000	0x600C_4FFF	
Interrupt Priority Register (INTPRI)	0x600C_5000	0x600C_5FFF	4
Reserved	0x600C_6000	0x600C_FFFF	

* The address space of this module/peripheral is not continuous.

Note:

As shown in the figure 5-1

- HP CPU can access all peripherals listed in the table 5-2.
- LP CPU can access all peripherals listed in the table 5-2 except RISC-V Trace Encoder (TRACE), DEBUG ASSIST (ASSIST_DEBUG) and Interrupt Priority Register (INTPRI).

6 eFuse Controller

6.1 Overview

ESP32-C6 contains a 4096-bit eFuse memory to store parameters and user data. The parameters include control parameters for some hardware modules, system data parameters and keys used for the decryption module. Once an eFuse bit is programmed to 1, it can never be reverted to 0. The eFuse controller programs individual bits of parameters in eFuse according to user configurations. From outside the chip, eFuse data can only be read via the eFuse controller. For some data, such as some keys stored in eFuse for internal use by hardware cryptography modules (e.g., digital signature, HMAC), if read protection is not enabled, the data can be read from outside the chip; if read protection is enabled, the data cannot be read from outside the chip.

6.2 Features

- 4096-bit one-time programmable storage including 1792 bits reserved for custom use
- Configurable write protection
- Configurable read protection
- Various hardware encoding schemes against data corruption

6.3 Functional Description

6.3.1 Structure

The eFuse system consists of the eFuse controller and eFuse memory. Data flow in this system is shown in Figure 6-1.

Users can program bits in the eFuse memory via the eFuse controller by writing the data to be programmed to the programming register and executing the programming instruction. For detailed programming steps, please refer to Section 6.3.2.

Users cannot directly read the data programmed in the eFuse memory, so they need to read the programmed data into the Reading Data Register of the corresponding address segment through the eFuse controller. During the reading process, if the data is inconsistent with that in the eFuse memory, the eFuse controller can automatically correct it through the hardware encoding mechanism (see Section 6.3.1.3 for details), and send the error message to the error report register. For detailed steps to read parameters, please refer to the Section 6.3.3.

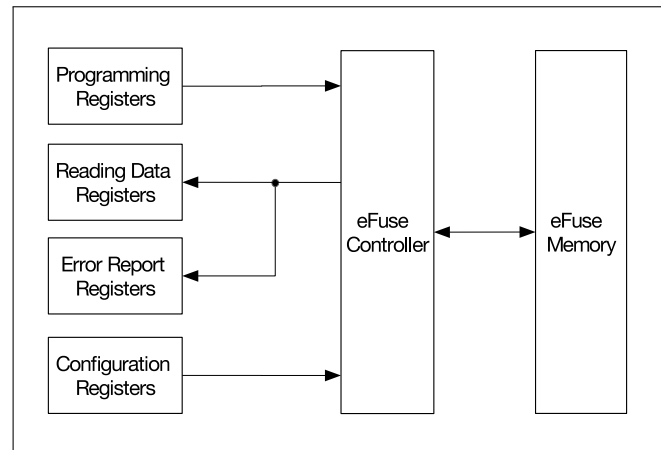

Figure 6-1. Data Flow in eFuse

Data in eFuse memory is organized in 11 blocks (BLOCK0 ~ BLOCK10).

BLOCK0 holds most parameters for software and hardware uses.

Table 6-1 lists all the parameters accessible (readable and usable) to users in BLOCK0 and their offsets, bit widths, accessibility by hardware, write protection, and brief function description. For more description on the parameters, please click the link of the corresponding parameter in the table.

The [EFUSE_WR_DIS](#) parameter is used to disable write protection of other parameters. [EFUSE_RD_DIS](#) is used to disable read protection of BLOCK4 ~ BLOCK10. For more information on these two parameters, please see Section 6.3.1.1 and Section 6.3.1.2.

Table 6-1. Parameters in eFuse BLOCK0

Parameters	Bit Width	Accessible by Hardware	Write Protection by EFUSE_WR_DIS Bit Number	Description
EFUSE_WR_DIS	32	Y	N/A	Represents whether writing of eFuse bits by eFuse controller is disabled.
EFUSE_RD_DIS	7	Y	0	Represents whether reading data from BLOCK4 ~ 10 in eFuse memory by users is disabled.
EFUSE_SWAP_UART_SDIO_EN	1	Y	2	Represents whether the pads of UART and SDIO are swapped or not.
EFUSE_DIS_ICACHE	1	Y	2	Represents whether iCache is disabled.
EFUSE_DIS_USB_JTAG	1	Y	2	Represents whether the USB-to-JTAG function in the USB module is disabled.
EFUSE_DIS_DOWNLOAD_ICACHE	1	Y	2	Represents whether iCache is disabled in Download mode.
EFUSE_DIS_USB_SERIAL_JTAG	1	Y	2	Represents whether the USB_Serial_JTAG module is disabled.
EFUSE_DIS_FORCE_DOWNLOAD	1	Y	2	Represents whether the function to force the chip into Download mode is disabled.
EFUSE_SPI_DOWNLOAD_MSPI_DIS	1	Y	17	Represents whether the SPI0 controller is disabled in boot_mode_download.
EFUSE_DIS_TWAI	1	Y	2	Represents whether the TWAI controller is disabled.
EFUSE_JTAG_SEL_ENABLE	1	Y	2	Represents whether the selection of a JTAG signal source through the strapping value of GPIO15 is enabled when both EFUSE_DIS_PAD_JTAG and EFUSE_DIS_USB_JTAG are configured to 0.
EFUSE_SOFT_DIS_JTAG	3	Y	31	Represents whether JTAG is disabled in the soft way.
EFUSE_DIS_PAD_JTAG	1	Y	2	Represents whether JTAG is disabled in the hard way (permanently).

Cont'd on next page

Table 6-1 – cont'd from previous page

Parameters	Bit Width	Accessible by Hardware	Write Protection by EFUSE_WR_DIS Bit Number	Description
EFUSE_DIS_DOWNLOAD_MANUAL_ENCRYPT	1	Y	2	Represents whether flash encryption is disabled (except in SPI boot mode).
EFUSE_USB_EXCHG_PINS	1	Y	30	Represents whether the D+ and D- pins are exchanged.
EFUSE_VDD_SPI_AS_GPIO	1	Y	30	Represents whether the VDD_SPI pin is used as a regular GPIO.
EFUSE_WDT_DELAY_SEL	2	Y	3	Represents whether RTC watchdog timeout threshold is selected at startup.
EFUSE_SPI_BOOT_CRYPT_CNT	3	Y	4	Represents whether SPI boot encryption/decryption is enabled.
EFUSE_SECURE_BOOT_KEY_REVOKE0	1	N	5	Represents whether revoking the first Secure Boot key is enabled.
EFUSE_SECURE_BOOT_KEY_REVOKE1	1	N	6	Represents whether revoking the second Secure Boot key is enabled.
EFUSE_SECURE_BOOT_KEY_REVOKE2	1	N	7	Represents whether revoking the third Secure Boot key is enabled.
EFUSE_KEY_PURPOSE_0	4	Y	8	Represents Key0 purpose. See Table 6-2.
EFUSE_KEY_PURPOSE_1	4	Y	9	Represents Key1 purpose. See Table 6-2.
EFUSE_KEY_PURPOSE_2	4	Y	10	Represents Key2 purpose. See Table 6-2.
EFUSE_KEY_PURPOSE_3	4	Y	11	Represents Key3 purpose. See Table 6-2.
EFUSE_KEY_PURPOSE_4	4	Y	12	Represents Key4 purpose. See Table 6-2.
EFUSE_KEY_PURPOSE_5	4	Y	13	Represents Key5 purpose. See Table 6-2.
EFUSE_SEC_DPA_LEVEL	2	Y	14	Represents the security level of anti-DPA (differential power analysis) attack.
EFUSE_CRYPT_DPA_ENABLE	1	Y	15	Represents whether defense against DPA attack is enabled.
EFUSE_SECURE_BOOT_EN	1	N	16	Represents whether Secure Boot is enabled or disabled.

Cont'd on next page

Table 6-1 – cont'd from previous page

Parameters	Bit Width	Accessible by Hardware	Write Protection by EFUSE_WR_DIS Bit Number	Description
EFUSE_SECURE_BOOT_AGGRESSIVE_REVOKE	1	N	16	Represents whether aggressive revocation of Secure Boot is enabled.
EFUSE_FLASH_TPUW	4	N	18	Represents the flash waiting time after power-up.
EFUSE_DIS_DOWNLOAD_MODE	1	N	18	Represents whether all download modes are disabled.
EFUSE_DIS_DIRECT_BOOT	1	N	18	Represents whether direct boot mode is disabled.
EFUSE_DIS_USB_SERIAL_JTAG_ROM_PRINT	1	N	18	Represents whether print from USB-Serial-JTAG during ROM boot is disabled.
EFUSE_DIS_USB_SERIAL_JTAG_DOWNLOAD_MODE	1	N	18	Represents whether the USB-Serial-JTAG download function is disabled.
EFUSE_ENABLE_SECURITY_DOWNLOAD	1	N	18	Represents whether security download is enabled.
EFUSE_UART_PRINT_CONTROL	2	N	18	Represents the type of UART printing.
EFUSE_FORCE_SEND_RESUME	1	N	18	Represents whether ROM code is forced to send a resume command during SPI boot.
EFUSE_SECURE_VERSION	16	N	18	Represents the version used by ESP-IDF anti-rollback feature.
EFUSE_SECURE_BOOT_DISABLE_FAST_WAKE	1	N	19	Represents whether FAST VERIFY ON WAKE is disabled or enabled when Secure Boot is enabled.

Table 6-2 lists all key purposes and their values. Setting the eFuse parameter `EFUSE_KEY_PURPOSE_` n declares the purpose of `KEY n` (n : 0 ~ 5).

Table 6-2. Secure Key Purpose Values

Key Purpose Values	Purposes
0	User purposes
1	Reserved
2	Reserved
3	Reserved
4	XTS_AES_128_KEY (flash/SRAM encryption and decryption)
5	HMAC Downstream mode (both JTAG and DS)
6	JTAG in HMAC Downstream mode
7	Digital Signature peripheral in HMAC Downstream mode
8	HMAC Upstream mode
9	SECURE_BOOT_DIGEST0 (secure boot key digest)
10	SECURE_BOOT_DIGEST1 (secure boot key digest)
11	SECURE_BOOT_DIGEST2 (secure boot key digest)

Table 6-3 provides the details of parameters in BLOCK1 ~ BLOCK10.

Table 6-3. Parameters in BLOCK1 to BLOCK10

BLOCK	Parameters	Bit Width	Accessible by Hardware	Write Protection by EFUSE_WR_DIS Bit Number	Read Protection by EFUSE_RD_DIS Bit Number	Description
BLOCK1	EFUSE_MAC	48	N	20	N/A	MAC address
	EFUSE_MAC_EXT	16	N	20	N/A	Extended MAC address
	EFUSE_SYS_DATA_PART0	69	N	20	N/A	System data
BLOCK2	EFUSE_SYS_DATA_PART1	256	N	21	N/A	System data
BLOCK3	EFUSE_USR_DATA	256	N	22	N/A	User data
BLOCK4	EFUSE_KEY0_DATA	256	Y	23	0	KEY0 or user data
BLOCK5	EFUSE_KEY1_DATA	256	Y	24	1	KEY1 or user data
BLOCK6	EFUSE_KEY2_DATA	256	Y	25	2	KEY2 or user data
BLOCK7	EFUSE_KEY3_DATA	256	Y	26	3	KEY3 or user data
BLOCK8	EFUSE_KEY4_DATA	256	Y	27	4	KEY4 or user data
BLOCK9	EFUSE_KEY5_DATA	256	Y	28	5	KEY5 or user data
BLOCK10	EFUSE_SYS_DATA_PART2	256	N	29	6	System data

Among these blocks, BLOCK4 ~ 9 can be used to store KEY0 ~ 5. Up to six 256-bit keys can be written into eFuse. Whenever a key is written, its purpose value should also be written (see table 6-2). For example, when a key for the JTAG function in HMAC Downstream mode is written to KEY3 (i.e., BLOCK7), its key purpose value 6 should also be written to EFUSE_KEY_PURPOSE_3.

Note:

Do not program the XTS-AES key into the KEY5 block, i.e., BLOCK9. Otherwise, the key may be unreadable. Instead, program it into the preceding blocks, i.e., BLOCK4 ~ BLOCK8. The last block, BLOCK9, is used to program other keys.

BLOCK1 ~ BLOCK10 use the RS coding scheme, so there are some limitations on writing to these parameters. For more detailed information, please refer to Section 6.3.1.3 and Section 6.3.2.

6.3.1.1 EFUSE_WR_DIS

Parameter EFUSE_WR_DIS determines whether individual eFuse parameters are write-protected. After EFUSE_WR_DIS has been programmed, execute an eFuse read operation so the new values would take effect.

Column “Write Protection by EFUSE_WR_DIS Bit Number” in Table 6-1 and Table 6-3 list the specific bits in EFUSE_WR_DIS that disable writing.

When the write protection bit of a parameter is set to 0, it means that this parameter is not write-protected and can be programmed, unless it has been programmed before.

When the write protection bit of a parameter is set to 1, it means that this parameter is write-protected and none of its bits can be modified, with non-programmed bits always remaining 0 and programmed bits always remaining 1. That is to say, if a parameter is write-protected, it will always remain in this state and cannot be changed.

6.3.1.2 EFUSE_RD_DIS

Only the parameters in BLOCK4 ~ BLOCK10 can be set to be read-protected from users, as shown in column “Read Protection by EFUSE_RD_DIS Bit Number” of Table 6-3. After EFUSE_RD_DIS has been programmed, execute an eFuse read operation so the new values would take effect.

If the corresponding EFUSE_RD_DIS bit is 0, the parameter controlled by this bit is not read-protected from users. If it is 1, the parameter controlled by it is read-protected from users.

Other parameters that are not in BLOCK4 ~ BLOCK10 can always be read by users.

When BLOCK4 ~ BLOCK10 are set to be read-protected, the data in them can still be read by hardware cryptography modules if the EFUSE_KEY_PURPOSE_*n* bit is set accordingly.

6.3.1.3 Data Storage

Internally, eFuse uses the hardware encoding scheme to protect data from corruption. The scheme and the encoding process are invisible to users.

All BLOCK0 parameters except for EFUSE_WR_DIS are stored with four backups, meaning each bit is stored four times. This backup scheme is not visible to users.

In BLOCK0, `EFUSE_WR_DIS` occupies 32 bits, and other parameters takes 152 bits each. So, the eFuse memory space occupied by BLOCK0 is $32 + 152 * 4 = 640$ bits.

BLOCK1 ~ BLOCK10 use RS (44, 32) coding scheme that supports up to 6 bytes of automatic error correction. The primitive polynomial of RS (44, 32) is $p(x) = x^8 + x^4 + x^3 + x^2 + 1$.

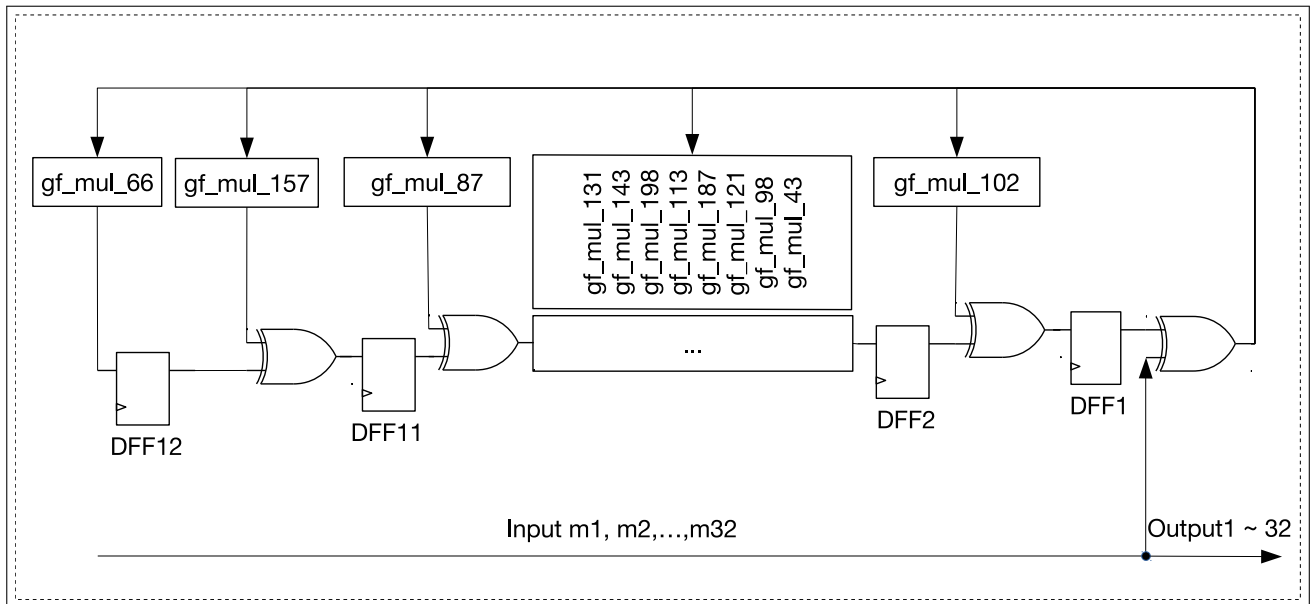

Figure 6-2. Shift Register Circuit (first 32 output)

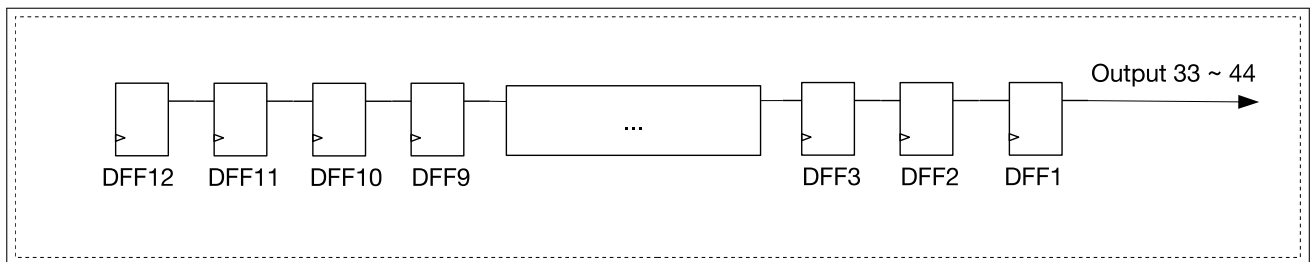

Figure 6-3. Shift Register Circuit (last 12 output)

The shift register circuit shown in Figure 6-2 and 6-3 processes 32 data bytes using RS (44, 32). This coding scheme encodes 32 bytes of data into 44 bytes:

- Bytes [0:31] are the data bytes itself
- Bytes [32:43] are the encoded parity bytes stored in 8-bit flip-flops DFF1, DFF2, ..., DFF12 (gf_mul_n is the result of multiplying a byte of data in $GF(2^8)$ by α^n , where n is an integer).

After that, the hardware programs into eFuse the 44-byte codeword consisting of the data bytes and the parity bytes. When the eFuse block is read, the eFuse controller automatically decodes the codeword and applies error correction if needed.

Because the RS check codes are generated on the entire 32-byte eFuse block, each block can only be written once.

Since the size of BLOCK1 is less than 32 bytes, the unused bits will be treated as 0 by hardware during the RS (44, 32) encoding. Thus, the final coding result will not be affected.

Among blocks using the RS (44, 32) coding scheme, the parameters in BLOCK1 is 24 bytes, and the RS check code is 12 bytes, so BLOCK1 occupies $24 + 12 = 36$ bytes in eFuse memory.

The parameter in other blocks (Block2 ~ 10) is 32 bytes respectively, and the RS check code is 12 bytes, so they occupy $(32 + 12) * 9 = 396$ bytes in eFuse memory.

6.3.2 Programming of Parameters

The eFuse controller can only program eFuse parameters in one block at a time. BLOCK0 ~ BLOCK10 share the same address range to store the parameters to be programmed. Configure parameter [EFUSE_BLK_NUM](#) to indicate which block should be programmed.

Since there is a one-to-one correspondence between the reading data registers and the programming data registers (see table 6-4 for details), users can find out where the data to be programmed is located in programming registers by checking the parameter description and the parameter location in the corresponding read registers.

For example, if the user wants to program the parameter [EFUSE_DIS_ICACHE](#) in BLOCK0 to 1, they can first search the reading data registers [EFUSE_RD_REPEAT_DATA0 ~ 4_REG](#) in BLOCK0 for where the parameter is located, namely, the 8th bit in [EFUSE_RD_REPEAT_DATA0_REG](#). So, the user can set the 8th bit of [EFUSE_PGM_DATA1_REG](#) to 1 and follow the programming steps below. After the steps are completed, the corresponding bit in the eFuse memory will be programmed to 1.

Programming preparation

- **Programming BLOCK0**

1. Set [EFUSE_BLK_NUM](#) to 0.
2. Write into [EFUSE_PGM_DATA0_REG ~ EFUSE_PGM_DATA5_REG](#) the data to be programmed to BLOCK0.
The data in [EFUSE_PGM_DATA6_REG ~ EFUSE_PGM_DATA7_REG](#) and [EFUSE_PGM_CHECK_VALUE0_REG ~ EFUSE_PGM_CHECK_VALUE2_REG](#) does not affect the programming of BLOCK0.

- **Programming BLOCK1**

1. Set [EFUSE_BLK_NUM](#) to 1.
2. Write into [EFUSE_PGM_DATA0_REG ~ EFUSE_PGM_DATA5_REG](#) the data to be programmed to BLOCK1. Write into [EFUSE_PGM_CHECK_VALUE0_REG ~ EFUSE_PGM_CHECK_VALUE2_REG](#) the corresponding RS check code.
The data in [EFUSE_PGM_DATA6_REG ~ EFUSE_PGM_DATA7_REG](#) does not affect the programming of BLOCK1. When calculating RS check of BLOCK1 using software, please treat the 8 bytes as 0.

- **Programming BLOCK2 ~ 10**

1. Set [EFUSE_BLK_NUM](#) to the block number.
2. Write into [EFUSE_PGM_DATA0_REG ~ EFUSE_PGM_DATA7_REG](#) the data to be programmed. Write into [EFUSE_PGM_CHECK_VALUE0_REG ~ EFUSE_PGM_CHECK_VALUE2_REG](#) the corresponding RS code.

Programming process

The process of programming parameters is as follows:

1. Configure the value of parameter [EFUSE_BLK_NUM](#) to determine the block to be programmed.
2. Write parameters to be programmed to registers [EFUSE_PGM_DATA0_REG ~ EFUSE_PGM_DATA7_REG](#) and [EFUSE_PGM_CHECK_VALUE0_REG ~ EFUSE_PGM_CHECK_VALUE2_REG](#).
3. Make sure the eFuse programming voltage VDDQ is configured correctly as described in Section 6.3.4.
4. Configure the field [EFUSE_OP_CODE](#) of register [EFUSE_CONF_REG](#) to 0x5A5A.
5. Configure the field [EFUSE_PGM_CMD](#) of register [EFUSE_CMD_REG](#) to 1.
6. Poll register [EFUSE_CMD_REG](#) until it is 0x0, or wait for a PGM_DONE interrupt. For more information on how to identify a PGM_DONE or READ_DONE interrupt, please see the end of Section 6.3.3.
7. Clear the parameters in [EFUSE_PGM_DATA0_REG ~ EFUSE_PGM_DATA7_REG](#) and [EFUSE_PGM_CHECK_VALUE0_REG ~ EFUSE_PGM_CHECK_VALUE2_REG](#).
8. Trigger an eFuse read operation (see Section 6.3.3) to update eFuse registers with the new values.
9. Check error record registers. If the values read in error record registers are not 0, the programming process should be performed again following above steps 1 ~ 7. Please check the following error record registers for different eFuse blocks:
 - BLOCK0: [EFUSE_RD_REPEAT_ERR0_REG ~ EFUSE_RD_REPEAT_ERR4_REG](#)
 - BLOCK1: [EFUSE_MAC_SPI_8M_ERR_NUM, EFUSE_MAC_SPI_8M_FAIL](#)
 - BLOCK2: [EFUSE_SYS_PART1_ERR_NUM, EFUSE_SYS_PART1_FAIL](#)
 - BLOCK3: [EFUSE_USR_DATA_ERR_NUM, EFUSE_USR_DATA_FAIL](#)
 - BLOCK4: [EFUSE_KEY0_ERR_NUM, EFUSE_KEY0_FAIL](#)
 - BLOCK5: [EFUSE_KEY1_ERR_NUM, EFUSE_KEY1_FAIL](#)
 - BLOCK6: [EFUSE_KEY2_ERR_NUM, EFUSE_KEY2_FAIL](#)
 - BLOCK7: [EFUSE_KEY3_ERR_NUM, EFUSE_KEY3_FAIL](#)
 - BLOCK8: [EFUSE_KEY4_ERR_NUM, EFUSE_KEY4_FAIL](#)
 - BLOCK9: [EFUSE_KEY5_ERR_NUM, EFUSE_KEY5_FAIL](#)
 - BLOCK10: [EFUSE_SYS_PART2_ERR_NUM, EFUSE_SYS_PART2_FAIL](#)

Limitations

In BLOCK0, each bit can be programmed separately. However, we recommend to minimize programming cycles and program all the bits of a parameter in one programming action. In addition, after all parameters controlled by a certain bit of [EFUSE_WR_DIS](#) are programmed, that bit should be immediately programmed. The programming of parameters controlled by a certain bit of [EFUSE_WR_DIS](#), and the programming of the bit itself can even be completed at the same time in one programming action.

BLOCK1 cannot be programmed by users as it has been programmed at manufacturing.

BLOCK2 ~ 10 can only be programmed once. Repeated programming is not allowed.

6.3.3 Reading of Parameters by Users

Users cannot read eFuse bits directly. The eFuse controller hardware reads all eFuse bits and stores the results to their corresponding registers in its memory space. Then, users can read eFuse bits by reading the registers that start with EFUSE_RD_. Details are provided in Table 6-4.

Table 6-4. Registers Information

BLOCK	Read Registers	Registers When Programming This Block
0	EFUSE_RD_WR_DIS_REG	EFUSE_PGM_DATA0_REG
0	EFUSE_RD_REPEAT_DATA0 ~ 4_REG	EFUSE_PGM_DATA1 ~ 5_REG
1	EFUSE_RD_MAC_SPI_SYS_0 ~ 5_REG	EFUSE_PGM_DATA0 ~ 5_REG
2	EFUSE_RD_SYS_DATA_PART1_0 ~ 7_REG	EFUSE_PGM_DATA0 ~ 7_REG
3	EFUSE_RD_USR_DATA0 ~ 7_REG	EFUSE_PGM_DATA0 ~ 7_REG
4-9	EFUSE_RD_KEY_n_DATA0 ~ 7_REG (<i>n</i> : 0 ~ 5)	EFUSE_PGM_DATA0 ~ 7_REG
10	EFUSE_RD_SYS_DATA_PART2_0 ~ 7_REG	EFUSE_PGM_DATA0 ~ 7_REG

Updating reading data registers

The eFuse controller reads eFuse memory to update corresponding registers. This read operation happens at system reset and can also be triggered manually by users as needed (e.g., if new eFuse values have been programmed). The process of triggering a read operation by users is as follows:

1. Configure the field [EFUSE_OP_CODE](#) in register [EFUSE_CONF_REG](#) to 0x5AA5.
2. Configure the field [EFUSE_READ_CMD](#) in register [EFUSE_CMD_REG](#) to 1.
3. Poll register [EFUSE_CMD_REG](#) until it is 0x0, or wait for a READ_DONE interrupt. Information on how to identify a PGM_DONE or READ_DONE interrupt is provided below in this section.
4. Read the values of each parameter from eFuse memory.

The eFuse read registers will hold all values until the next read operation.

Error detection

Error record registers allow users to detect if there is any inconsistency between the parameter read by eFuse controller and that in eFuse memory.

Registers [EFUSE_RD_REPEAT_ERR0 ~ 3_REG](#) indicate if there are any errors in programming parameters (except [EFUSE_WR_DIS](#)) to BLOCK0. The value 1 indicates an error is detected in programming the corresponding bit. The value 0 indicates no error.

Registers [EFUSE_RD_RS_ERR0 ~ 1_REG](#) store the number of corrected bytes as well as the result of RS decoding when eFuse controller reads BLOCK1 ~ BLOCK10.

The values of the above registers will be updated every time the reading data registers of eFuse controller have been updated.

Identifying program/read operation

The methods to identify the completion of a program/read operation are described below. Please note that bit 1 corresponds to a program operation, and bit 0 corresponds to a read operation.

- Method one: Poll bit 1/0 in register [EFUSE_INT_RAW_REG](#) until it becomes 1, which represents the completion of a program/read operation.
- Method two:
 1. Set bit 1/0 in register [EFUSE_INT_ENA_REG](#) to 1 to enable the eFuse controller to post a PGM_DONE or READ_DONE interrupt.
 2. Configure the Interrupt Matrix to enable the CPU to respond to eFuse interrupt signals. See Chapter [10 Interrupt Matrix \(INTMTX\)](#).
 3. Wait for the PGM_DONE or READ_DONE interrupt.
 4. Set bit 1/0 in register [EFUSE_INT_CLR_REG](#) to 1 to clear the PGM_DONE or READ_DONE interrupt.

Note

When eFuse controller is updating its registers, it will use [EFUSE_PGM_DATA_n_REG](#) (n=0, 1, ... ,7) again to store data. So please do not write important data into these registers before this updating process is initiated. During the chip boot process, eFuse controller will automatically update data from eFuse memory into the registers that can be accessed by users. Users can get programmed eFuse data by reading corresponding registers. Thus, there is no need to update the reading data registers in such case.

6.3.4 eFuse VDDQ Timing

The eFuse controller operates at the clock frequency of 20 MHz, and its programming voltage VDDQ should be configured as follows:

- [EFUSE_DAC_NUM](#) (the rising period of VDDQ): The default value of VDDQ is 2.5 V and the voltage increases by 0.01 V in each clock cycle. The default value of this parameter is 255.
- [EFUSE_DAC_CLK_DIV](#) (the clock divisor of VDDQ): The clock period to program VDDQ should be larger than 1 μ s.
- [EFUSE_PWR_ON_NUM](#) (the power-up time for VDDQ): The programming voltage should be stabilized after this time, which means the value of this parameter should be configured to exceed the result of [EFUSE_DAC_CLK_DIV](#) times [EFUSE_DAC_NUM](#).
- [EFUSE_PWR_OFF_NUM](#) (the power-out time for VDDQ): The value of this parameter should be larger than 10 μ s.

Table 6-5. Configuration of Default VDDQ Timing Parameters

EFUSE_DAC_NUM	EFUSE_DAC_CLK_DIV	EFUSE_PWR_ON_NUM	EFUSE_PWR_OFF_NUM
0xFF	0x28	0x3000	0x190

6.3.5 Parameters Used by Hardware Modules

Some hardware modules are directly connected to the eFuse peripheral in order to use the parameters that are marked with “Y” in columns “Accessible by Hardware” of Table 6-1 and Table 6-3. Users cannot intervene in this process.

6.3.6 Interrupts

- PGM_DONE interrupt: Triggered when eFuse programming has finished. To enable this interrupt, set the [EFUSE_PGM_DONE_INT_ENA](#) field of register [EFUSE_INT_ENA_REG](#) to 1.
- READ_DONE interrupt: Triggered when eFuse reading has finished. To enable this interrupt, set the [EFUSE_READ_DONE_INT_ENA](#) field of register [EFUSE_INT_ENA_REG](#) to 1.

6.4 Register Summary

The addresses in this section are relative to eFuse controller base address provided in Table 5-2 in Chapter 5 *System and Memory*.

The abbreviations given in Column **Access** are explained in Section *Access Types for Registers*.

Name	Description	Address	Access
Programming Data Register			
EFUSE_PGM_DATA0_REG	Register 0 that stores data to be programmed	0x0000	R/W
EFUSE_PGM_DATA1_REG	Register 1 that stores data to be programmed	0x0004	R/W
EFUSE_PGM_DATA2_REG	Register 2 that stores data to be programmed	0x0008	R/W
EFUSE_PGM_DATA3_REG	Register 3 that stores data to be programmed	0x000C	R/W
EFUSE_PGM_DATA4_REG	Register 4 that stores data to be programmed	0x0010	R/W
EFUSE_PGM_DATA5_REG	Register 5 that stores data to be programmed	0x0014	R/W
EFUSE_PGM_DATA6_REG	Register 6 that stores data to be programmed	0x0018	R/W
EFUSE_PGM_DATA7_REG	Register 7 that stores data to be programmed	0x001C	R/W
EFUSE_PGM_CHECK_VALUE0_REG	Register 0 that stores the RS code to be programmed	0x0020	R/W
EFUSE_PGM_CHECK_VALUE1_REG	Register 1 that stores the RS code to be programmed	0x0024	R/W
EFUSE_PGM_CHECK_VALUE2_REG	Register 2 that stores the RS code to be programmed	0x0028	R/W
Reading Data Register			
EFUSE_RD_WR_DIS_REG	Register 0 of BLOCK0	0x002C	RO
EFUSE_RD_REPEAT_DATA0_REG	Register 1 of BLOCK0	0x0030	RO
EFUSE_RD_REPEAT_DATA1_REG	Register 2 of BLOCK0	0x0034	RO
EFUSE_RD_REPEAT_DATA2_REG	Register 3 of BLOCK0	0x0038	RO
EFUSE_RD_REPEAT_DATA3_REG	Register 4 of BLOCK0	0x003C	RO
EFUSE_RD_REPEAT_DATA4_REG	Register 5 of BLOCK0	0x0040	RO
EFUSE_RD_MAC_SPI_SYS_0_REG	Register 0 of BLOCK1	0x0044	RO
EFUSE_RD_MAC_SPI_SYS_1_REG	Register 1 of BLOCK1	0x0048	RO
EFUSE_RD_MAC_SPI_SYS_2_REG	Register 2 of BLOCK1	0x004C	RO
EFUSE_RD_MAC_SPI_SYS_3_REG	Register 3 of BLOCK1	0x0050	RO
EFUSE_RD_MAC_SPI_SYS_4_REG	Register 4 of BLOCK1	0x0054	RO
EFUSE_RD_MAC_SPI_SYS_5_REG	Register 5 of BLOCK1	0x0058	RO
EFUSE_RD_SYS_PART1_DATA0_REG	Register 0 of BLOCK2 (system)	0x005C	RO
EFUSE_RD_SYS_PART1_DATA1_REG	Register 1 of BLOCK2 (system)	0x0060	RO
EFUSE_RD_SYS_PART1_DATA2_REG	Register 2 of BLOCK2 (system)	0x0064	RO
EFUSE_RD_SYS_PART1_DATA3_REG	Register 3 of BLOCK2 (system)	0x0068	RO
EFUSE_RD_SYS_PART1_DATA4_REG	Register 4 of BLOCK2 (system)	0x006C	RO
EFUSE_RD_SYS_PART1_DATA5_REG	Register 5 of BLOCK2 (system)	0x0070	RO
EFUSE_RD_SYS_PART1_DATA6_REG	Register 6 of BLOCK2 (system)	0x0074	RO
EFUSE_RD_SYS_PART1_DATA7_REG	Register 7 of BLOCK2 (system)	0x0078	RO
EFUSE_RD_USR_DATA0_REG	Register 0 of BLOCK3 (user)	0x007C	RO
EFUSE_RD_USR_DATA1_REG	Register 1 of BLOCK3 (user)	0x0080	RO

Name	Description	Address	Access
EFUSE_RD_USR_DATA2_REG	Register 2 of BLOCK3 (user)	0x0084	RO
EFUSE_RD_USR_DATA3_REG	Register 3 of BLOCK3 (user)	0x0088	RO
EFUSE_RD_USR_DATA4_REG	Register 4 of BLOCK3 (user)	0x008C	RO
EFUSE_RD_USR_DATA5_REG	Register 5 of BLOCK3 (user)	0x0090	RO
EFUSE_RD_USR_DATA6_REG	Register 6 of BLOCK3 (user)	0x0094	RO
EFUSE_RD_USR_DATA7_REG	Register 7 of BLOCK3 (user)	0x0098	RO
EFUSE_RD_KEY0_DATA0_REG	Register 0 of BLOCK4 (KEY0)	0x009C	RO
EFUSE_RD_KEY0_DATA1_REG	Register 1 of BLOCK4 (KEY0)	0x00A0	RO
EFUSE_RD_KEY0_DATA2_REG	Register 2 of BLOCK4 (KEY0)	0x00A4	RO
EFUSE_RD_KEY0_DATA3_REG	Register 3 of BLOCK4 (KEY0)	0x00A8	RO
EFUSE_RD_KEY0_DATA4_REG	Register 4 of BLOCK4 (KEY0)	0x00AC	RO
EFUSE_RD_KEY0_DATA5_REG	Register 5 of BLOCK4 (KEY0)	0x00B0	RO
EFUSE_RD_KEY0_DATA6_REG	Register 6 of BLOCK4 (KEY0)	0x00B4	RO
EFUSE_RD_KEY0_DATA7_REG	Register 7 of BLOCK4 (KEY0)	0x00B8	RO
EFUSE_RD_KEY1_DATA0_REG	Register 0 of BLOCK5 (KEY1)	0x00BC	RO
EFUSE_RD_KEY1_DATA1_REG	Register 1 of BLOCK5 (KEY1)	0x00C0	RO
EFUSE_RD_KEY1_DATA2_REG	Register 2 of BLOCK5 (KEY1)	0x00C4	RO
EFUSE_RD_KEY1_DATA3_REG	Register 3 of BLOCK5 (KEY1)	0x00C8	RO
EFUSE_RD_KEY1_DATA4_REG	Register 4 of BLOCK5 (KEY1)	0x00CC	RO
EFUSE_RD_KEY1_DATA5_REG	Register 5 of BLOCK5 (KEY1)	0x00D0	RO
EFUSE_RD_KEY1_DATA6_REG	Register 6 of BLOCK5 (KEY1)	0x00D4	RO
EFUSE_RD_KEY1_DATA7_REG	Register 7 of BLOCK5 (KEY1)	0x00D8	RO
EFUSE_RD_KEY2_DATA0_REG	Register 0 of BLOCK6 (KEY2)	0x00DC	RO
EFUSE_RD_KEY2_DATA1_REG	Register 1 of BLOCK6 (KEY2)	0x00E0	RO
EFUSE_RD_KEY2_DATA2_REG	Register 2 of BLOCK6 (KEY2)	0x00E4	RO
EFUSE_RD_KEY2_DATA3_REG	Register 3 of BLOCK6 (KEY2)	0x00E8	RO
EFUSE_RD_KEY2_DATA4_REG	Register 4 of BLOCK6 (KEY2)	0x00EC	RO
EFUSE_RD_KEY2_DATA5_REG	Register 5 of BLOCK6 (KEY2)	0x00F0	RO
EFUSE_RD_KEY2_DATA6_REG	Register 6 of BLOCK6 (KEY2)	0x00F4	RO
EFUSE_RD_KEY2_DATA7_REG	Register 7 of BLOCK6 (KEY2)	0x00F8	RO
EFUSE_RD_KEY3_DATA0_REG	Register 0 of BLOCK7 (KEY3)	0x00FC	RO
EFUSE_RD_KEY3_DATA1_REG	Register 1 of BLOCK7 (KEY3)	0x0100	RO
EFUSE_RD_KEY3_DATA2_REG	Register 2 of BLOCK7 (KEY3)	0x0104	RO
EFUSE_RD_KEY3_DATA3_REG	Register 3 of BLOCK7 (KEY3)	0x0108	RO
EFUSE_RD_KEY3_DATA4_REG	Register 4 of BLOCK7 (KEY3)	0x010C	RO
EFUSE_RD_KEY3_DATA5_REG	Register 5 of BLOCK7 (KEY3)	0x0110	RO
EFUSE_RD_KEY3_DATA6_REG	Register 6 of BLOCK7 (KEY3)	0x0114	RO
EFUSE_RD_KEY3_DATA7_REG	Register 7 of BLOCK7 (KEY3)	0x0118	RO
EFUSE_RD_KEY4_DATA0_REG	Register 0 of BLOCK8 (KEY4)	0x011C	RO
EFUSE_RD_KEY4_DATA1_REG	Register 1 of BLOCK8 (KEY4)	0x0120	RO
EFUSE_RD_KEY4_DATA2_REG	Register 2 of BLOCK8 (KEY4)	0x0124	RO
EFUSE_RD_KEY4_DATA3_REG	Register 3 of BLOCK8 (KEY4)	0x0128	RO
EFUSE_RD_KEY4_DATA4_REG	Register 4 of BLOCK8 (KEY4)	0x012C	RO

Name	Description	Address	Access
EFUSE_RD_KEY4_DATA5_REG	Register 5 of BLOCK8 (KEY4)	0x0130	RO
EFUSE_RD_KEY4_DATA6_REG	Register 6 of BLOCK8 (KEY4)	0x0134	RO
EFUSE_RD_KEY4_DATA7_REG	Register 7 of BLOCK8 (KEY4)	0x0138	RO
EFUSE_RD_KEY5_DATA0_REG	Register 0 of BLOCK9 (KEY5)	0x013C	RO
EFUSE_RD_KEY5_DATA1_REG	Register 1 of BLOCK9 (KEY5)	0x0140	RO
EFUSE_RD_KEY5_DATA2_REG	Register 2 of BLOCK9 (KEY5)	0x0144	RO
EFUSE_RD_KEY5_DATA3_REG	Register 3 of BLOCK9 (KEY5)	0x0148	RO
EFUSE_RD_KEY5_DATA4_REG	Register 4 of BLOCK9 (KEY5)	0x014C	RO
EFUSE_RD_KEY5_DATA5_REG	Register 5 of BLOCK9 (KEY5)	0x0150	RO
EFUSE_RD_KEY5_DATA6_REG	Register 6 of BLOCK9 (KEY5)	0x0154	RO
EFUSE_RD_KEY5_DATA7_REG	Register 7 of BLOCK9 (KEY5)	0x0158	RO
EFUSE_RD_SYS_PART2_DATA0_REG	Register 0 of BLOCK10 (system)	0x015C	RO
EFUSE_RD_SYS_PART2_DATA1_REG	Register 1 of BLOCK9 (KEY5)	0x0160	RO
EFUSE_RD_SYS_PART2_DATA2_REG	Register 2 of BLOCK10 (system)	0x0164	RO
EFUSE_RD_SYS_PART2_DATA3_REG	Register 3 of BLOCK10 (system)	0x0168	RO
EFUSE_RD_SYS_PART2_DATA4_REG	Register 4 of BLOCK10 (system)	0x016C	RO
EFUSE_RD_SYS_PART2_DATA5_REG	Register 5 of BLOCK10 (system)	0x0170	RO
EFUSE_RD_SYS_PART2_DATA6_REG	Register 6 of BLOCK10 (system)	0x0174	RO
EFUSE_RD_SYS_PART2_DATA7_REG	Register 7 of BLOCK10 (system)	0x0178	RO
Report Register			
EFUSE_RD_REPEAT_ERR0_REG	Programming error record register 0 of BLOCK0	0x017C	RO
EFUSE_RD_REPEAT_ERR1_REG	Programming error record register 1 of BLOCK0	0x0180	RO
EFUSE_RD_REPEAT_ERR2_REG	Programming error record register 2 of BLOCK0	0x0184	RO
EFUSE_RD_REPEAT_ERR3_REG	Programming error record register 3 of BLOCK0	0x0188	RO
EFUSE_RD_REPEAT_ERR4_REG	Programming error record register 4 of BLOCK0	0x0190	RO
EFUSE_RD_RS_ERR0_REG	Programming error record register 0 of BLOCK1-10	0x01C0	RO
EFUSE_RD_RS_ERR1_REG	Programming error record register 1 of BLOCK1-10	0x01C4	RO
Configuration Register			
EFUSE_CLK_REG	eFuse clock configuration register	0x01C8	R/W
EFUSE_CONF_REG	eFuse operation mode configuration register	0x01CC	R/W
EFUSE_CMD_REG	eFuse command register	0x01D4	varies
EFUSE_DAC_CONF_REG	Controls the eFuse programming voltage	0x01E8	R/W
EFUSE_RD_TIM_CONF_REG	Configures read timing parameters	0x01EC	R/W
EFUSE_WR_TIM_CONF1_REG	Configuration register 1 of eFuse programming timing parameters	0x01F0	R/W
EFUSE_WR_TIM_CONF2_REG	Configuration register 2 of eFuse programming timing parameters	0x01F4	R/W

Name	Description	Address	Access
EFUSE_WR_TIM_CONF0_REG	Configuration register 0 of eFuse programming timing parameters	0x01F8	varies
Status Register			
EFUSE_STATUS_REG	eFuse status register	0x01D0	RO
Interrupt Register			
EFUSE_INT_RAW_REG	eFuse raw interrupt register	0x01D8	R/SS/WTC
EFUSE_INT_ST_REG	eFuse interrupt status register	0x01DC	RO
EFUSE_INT_ENA_REG	eFuse interrupt enable register	0x01E0	R/W
EFUSE_INT_CLR_REG	eFuse interrupt clear register	0x01E4	WO
Version Control Register			
EFUSE_DATE_REG	Version control register	0x01FC	R/W

6.5 Registers

The addresses in this section are relative to eFuse controller base address provided in Table 5-2 in Chapter 5 *System and Memory*.

Register 6.1. EFUSE_PGM_DATA0_REG (0x0000)

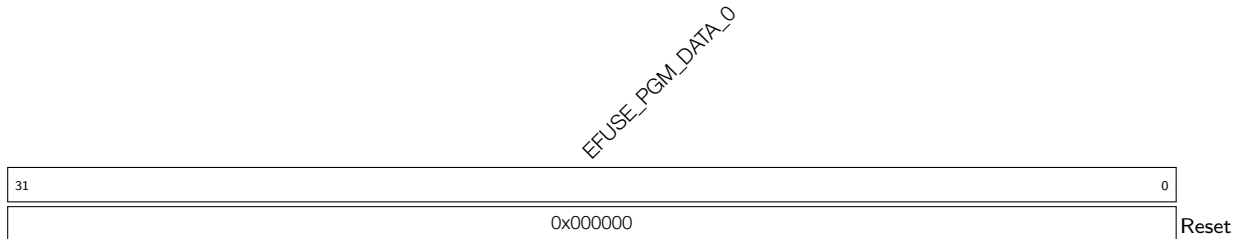

EFUSE_PGM_DATA_0 Configures the 0th 32-bit data to be programmed. (R/W)

Register 6.2. EFUSE_PGM_DATA1_REG (0x0004)

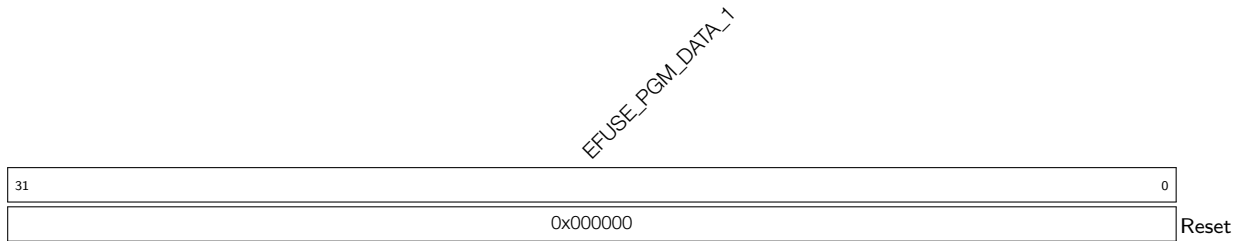

EFUSE_PGM_DATA_1 Configures the 1st 32-bit data to be programmed. (R/W)

Register 6.3. EFUSE_PGM_DATA2_REG (0x0008)

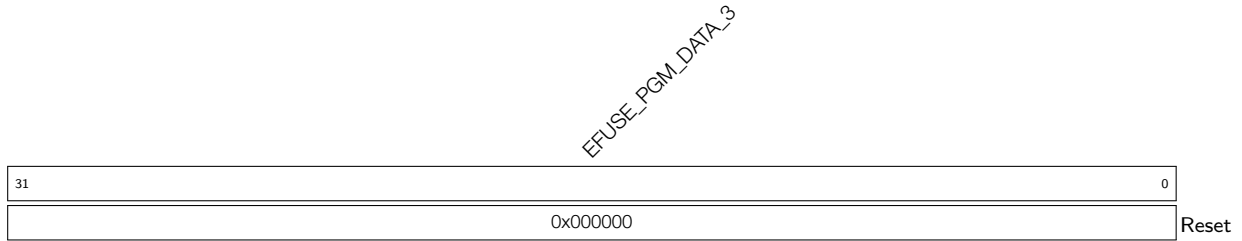

EFUSE_PGM_DATA_2 Configures the 2nd 32-bit data to be programmed. (R/W)

Register 6.4. EFUSE_PGM_DATA3_REG (0x000C)

EFUSE_PGM_DATA_3 Configures the 3rd 32-bit data to be programmed. (R/W)

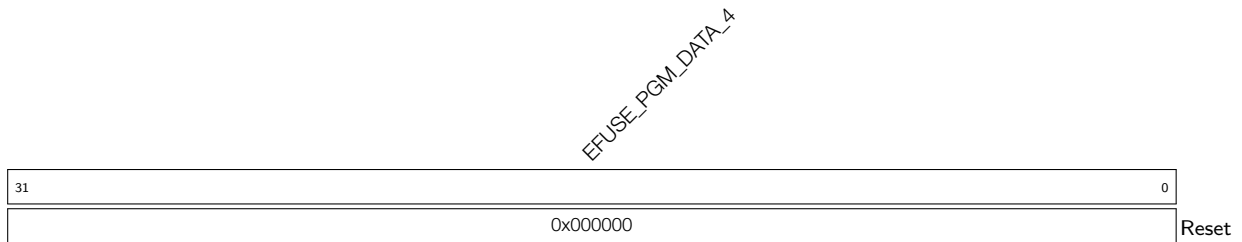
Register 6.5. EFUSE_PGM_DATA4_REG (0x0010)

EFUSE_PGM_DATA_4 Configures the 4th 32-bit data to be programmed. (R/W)

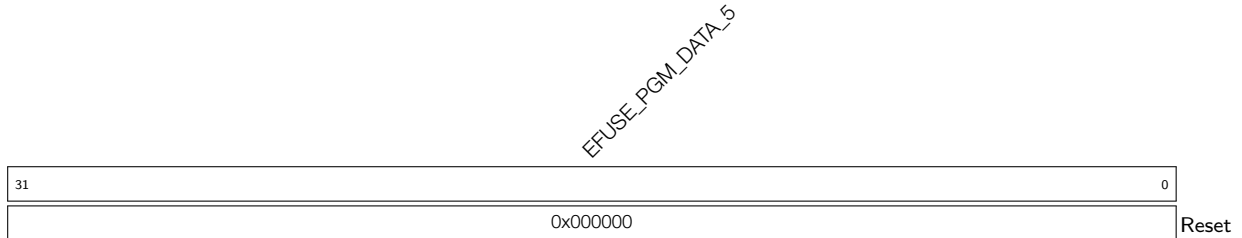
Register 6.6. EFUSE_PGM_DATA5_REG (0x0014)

EFUSE_PGM_DATA_5 Configures the 5th 32-bit data to be programmed. (R/W)

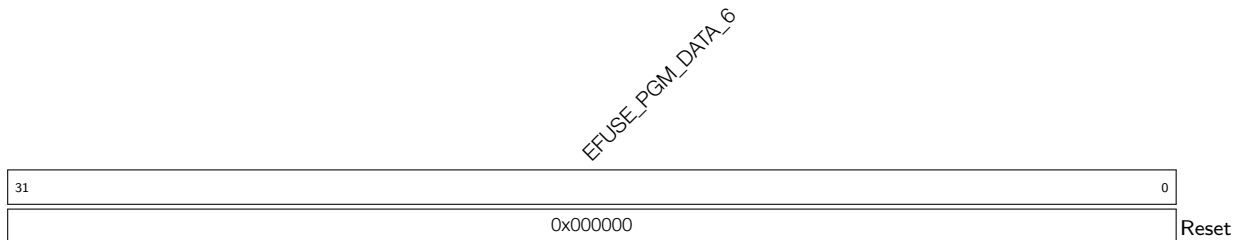
Register 6.7. EFUSE_PGM_DATA6_REG (0x0018)

EFUSE_PGM_DATA_6 Configures the 6th 32-bit data to be programmed. (R/W)

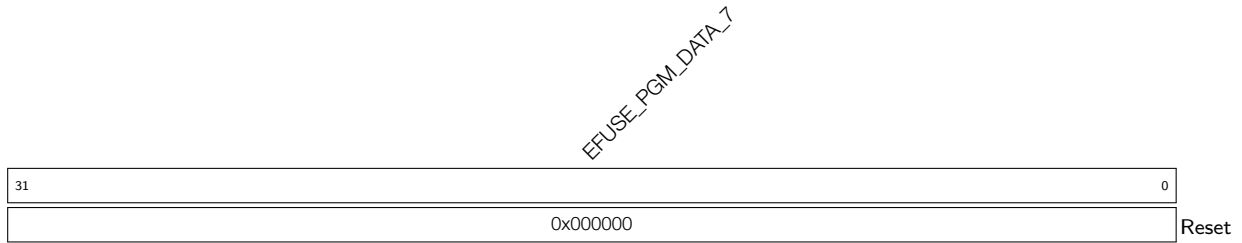
Register 6.8. EFUSE_PGM_DATA7_REG (0x001C)

EFUSE_PGM_DATA_7 Configures the 7th 32-bit data to be programmed. (R/W)

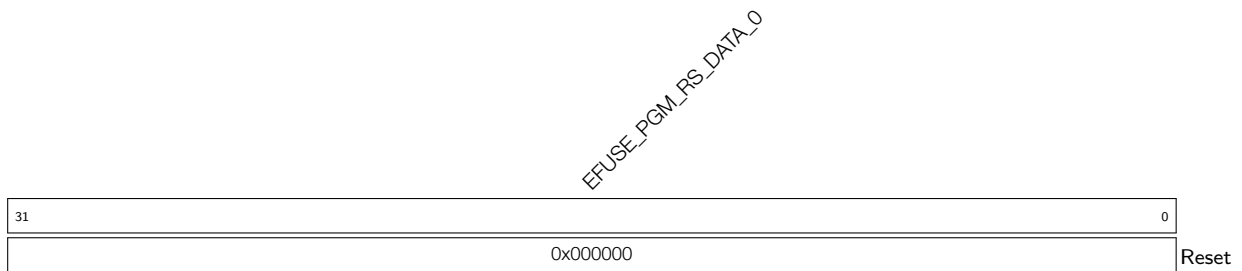
Register 6.9. EFUSE_PGM_CHECK_VALUE0_REG (0x0020)

EFUSE_PGM_RS_DATA_0 Configures the 0th 32-bit RS code to be programmed. (R/W)

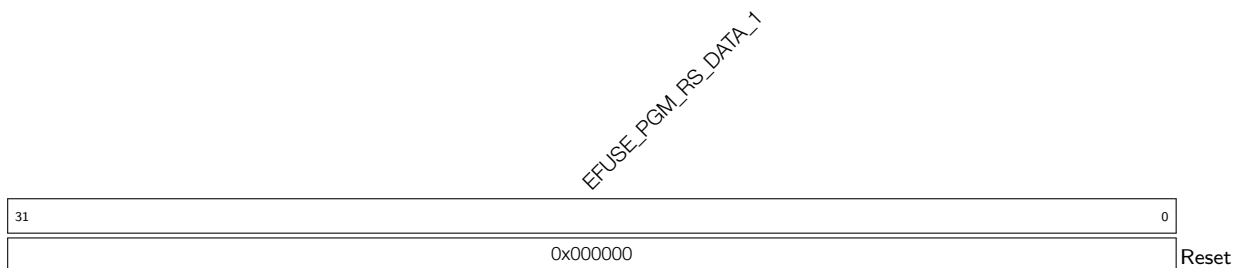
Register 6.10. EFUSE_PGM_CHECK_VALUE1_REG (0x0024)

EFUSE_PGM_RS_DATA_1 Configures the 1st 32-bit RS code to be programmed. (R/W)

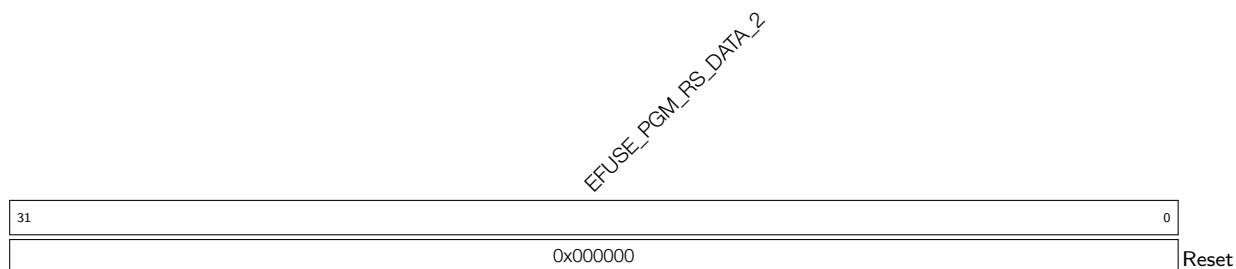
Register 6.11. EFUSE_PGM_CHECK_VALUE2_REG (0x0028)

EFUSE_PGM_RS_DATA_2 Configures the 2nd 32-bit RS code to be programmed. (R/W)

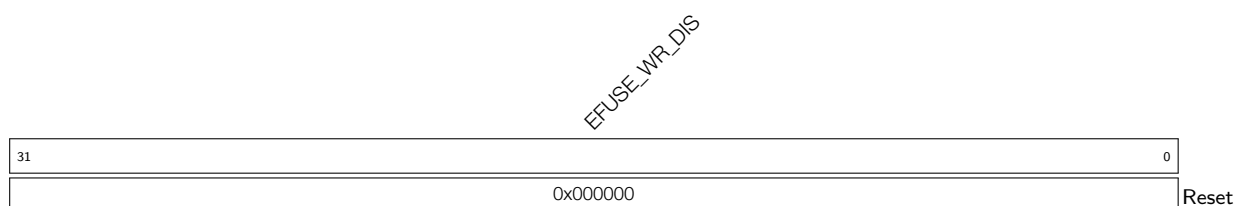
Register 6.12. EFUSE_RD_WR_DIS_REG (0x002C)

EFUSE_WR_DIS Represents whether programming of individual eFuse memory bit is disabled.

1: Disabled

0: Enabled

(RO)

Register 6.13. EFUSE_RD_REPEAT_DATA0_REG (0x0030)

EFUSE_RPT4_RESERVED0_0 EFUSE_RPT4_RESERVED0_1 EFUSE_RPT4_RESERVED0_2 EFUSE_VDD_SPI_AS_GPIO EFUSE_USB_EXCHG_PINS (reserved) EFUSE_DIS_DOWNLOAD_MANUAL_ENCRYPT EFUSE_DIS_PAD_JTAG EFUSE_SOFT_DIS_JTAG EFUSE_JTAG_SEL_ENABLE EFUSE_DIS_TWAI EFUSE_SPI_DOWNLOAD_FORCE_ENABLE EFUSE_DIS_FORCE_DOWNLOAD EFUSE_DIS_USB_SERIAL_JTAG EFUSE_DIS_DOWNLOAD_ICACHE EFUSE_DIS_ICACHE EFUSE_SWAP_UART_SDIO_EN EFUSE_RD_DIS																															
31	30	29	28	27	26	25	24	23	22	21	20	19	18	17	16	15	14	13	12	11	10	9	8	7	6	5	4	3	2	1	0
0x0	0	0x0	0	0	0	0	0	0	0	0	0	0	0x0	0	0	0	0	0	0	0	0	0	0	0	0	0	0	0	0	0	0x0

Reset

EFUSE_RD_DIS Represents whether reading of individual eFuse block (BLOCK4 ~ BLOCK10) is disabled.

- 1: Disabled
 - 0: Enabled
- (RO)

EFUSE_SWAP_UART_SDIO_EN Represents whether the pads of UART and SDIO are swapped or not.

- 1: Swapped
 - 0: Not swapped
- (RO)

EFUSE_DIS_ICACHE Represents whether icache is disabled.

- 1: Disabled
 - 0: Enabled
- (RO)

EFUSE_DIS_USB_JTAG Represents whether the USB-to-JTAG function is disabled.

- 1: Disabled
 - 0: Enabled
- (RO)

EFUSE_DIS_DOWNLOAD_ICACHE Represents whether iCache is disabled in Download mode.

- 1: Disabled
 - 0: Enabled
- (RO)

EFUSE_DIS_USB_SERIAL_JTAG Represents whether USB-Serial-JTAG is disabled.

- 1: Disabled
 - 0: Enabled
- (RO)

EFUSE_DIS_FORCE_DOWNLOAD Represents whether the function that forces chip into download mode is disabled.

- 1: Disabled
 - 0: Enabled
- (RO)

Register 6.13. EFUSE_RD_REPEAT_DATA0_REG (0x0030)

Continued from the previous page...

EFUSE_SPI_DOWNLOAD_MSPI_DIS Represents whether SPI0 controller is disabled during boot_mode_download.

1: Disabled

0: Enabled

(RO)

EFUSE_DIS_TWAI Represents whether TWAI function is disabled.

1: Disabled

0: Enabled

(RO)

EFUSE_JTAG_SEL_ENABLE Represents whether the selection of a JTAG signal source through the strapping value of GPIO15 is enabled when both [EFUSE_DIS_PAD_JTAG](#) and [EFUSE_DIS_USB_JTAG](#) are configured to 0.

1: Enabled

0: Disabled

(RO)

EFUSE_SOFT_DIS_JTAG Represents whether JTAG is disabled in the soft way. It can be restarted via HMAC.

Odd count of bits with a value of 1: Disabled

Even count of bits with a value of 1: Enabled

(RO)

EFUSE_DIS_PAD_JTAG Represents whether JTAG is disabled in the hard way (permanently).

1: Disabled

0: Enabled

(RO)

EFUSE_DIS_DOWNLOAD_MANUAL_ENCRYPT Represents whether flash encryption is disabled (except in SPI boot mode).

1: Disabled

0: Enabled

(RO)

EFUSE_USB_EXCHG_PINS Represents whether the D+ and D- pins are exchanged.

1: Exchanged

0: Not exchanged

(RO)

EFUSE_VDD_SPI_AS_GPIO Represents whether the VDD_SPI pin is used as a regular GPIO.

1: Used as a regular GPIO

0: Not used as a regular GPIO

(RO)

Continued on the next page...

Register 6.13. EFUSE_RD_REPEAT_DATA0_REG (0x0030)

Continued from the previous page...

EFUSE_RPT4_RESERVED0_2 Reserved. (RO)

EFUSE_RPT4_RESERVED0_1 Reserved. (RO)

EFUSE_RPT4_RESERVED0_0 Reserved. (RO)

Register 6.14. EFUSE_RD_REPEAT_DATA1_REG (0x0034)

31	28	27	24	23	22	21	20	18	17	16	15	0	
0x0	0x0	0	0	0	0x0	0x0	0x00						Reset

EFUSE_RPT4_RESERVED1_0 Reserved. (RO)

EFUSE_WDT_DELAY_SEL Represents whether RTC watchdog timeout threshold is selected at startup.

1: Selected.

0: Not selected

(RO)

EFUSE_SPI_BOOT_CRYPT_CNT Represents whether SPI boot encryption/decryption is enabled.

Odd count of bits with a value of 1: Enabled

Even count of bits with a value of 1: Disabled

(RO)

EFUSE_SECURE_BOOT_KEY_REVOKE0 Represents whether revoking the first Secure Boot key is enabled.

1: Enabled

0: Disabled

(RO)

EFUSE_SECURE_BOOT_KEY_REVOKE1 Represents whether revoking the second Secure Boot key is enabled.

1: Enabled

0: Disabled

(RO)

EFUSE_SECURE_BOOT_KEY_REVOKE2 Represents whether revoking the third Secure Boot key is enabled.

1: Enabled

0: Disabled

(RO)

EFUSE_KEY_PURPOSE_0 Represents the purpose of Key0. (RO)

EFUSE_KEY_PURPOSE_1 Represents the purpose of Key1. (RO)

Register 6.15. EFUSE_RD_REPEAT_DATA2_REG (0x0038)

31	28	27	22	21	20	19	18	17	16	15	12	11	8	7	4	3	0							
EFUSE_FLASH_TPUW		EFUSE_RPT4_RESERVED2_0			EFUSE_SECURE_BOOT_AGGRESSIVE_REVOKE			EFUSE_SECURE_BOOT_EN			EFUSE_CRYPT_DPA_ENABLE		EFUSE_RPT4_RESERVED2_1		EFUSE_SEC_DPA_LEVEL		EFUSE_KEY_PURPOSE_5		EFUSE_KEY_PURPOSE_4		EFUSE_KEY_PURPOSE_3		EFUSE_KEY_PURPOSE_2	
0x0		0x0			0	0	1	0	0x0		0x0		0x0		0x0		0x0		0x0		0x0		Reset	

EFUSE_KEY_PURPOSE_2 Represents the purpose of Key2. (RO)

EFUSE_KEY_PURPOSE_3 Represents the purpose of Key3. (RO)

EFUSE_KEY_PURPOSE_4 Represents the purpose of Key4. (RO)

EFUSE_KEY_PURPOSE_5 Represents the purpose of Key5. (RO)

EFUSE_SEC_DPA_LEVEL Represents the security level of anti-DPA attack.

0: Security level is SEC_DPA_OFF

1: Security level is SEC_DPA_LOW

2: Security level is SEC_DPA_MIDDLE

3: Security level is SEC_DPA_HIGH

For more information, please refer to Chapter [16 System Registers \(HP_SYSTEM\)](#) > Section [16.3.2](#).

(RO)

EFUSE_RPT4_RESERVED2_1 Reserved. (RO)

EFUSE_CRYPT_DPA_ENABLE Represents whether defense against DPA attack is enabled.

1: Enabled

0: Disabled

(RO)

EFUSE_SECURE_BOOT_EN Represents whether Secure Boot is enabled.

1: Enabled

0: Disabled

(RO)

EFUSE_SECURE_BOOT_AGGRESSIVE_REVOKE Represents whether aggressive revocation of Secure Boot is enabled.

1: Enabled

0: Disabled

(RO)

EFUSE_RPT4_RESERVED2_0 Reserved. (RO)

EFUSE_FLASH_TPUW Represents the flash waiting time after power-up. Measurement unit: ms.

When the value is less than 15, the waiting time is the programmed value. Otherwise, the waiting time is a fixed value, i.e. 30 ms. (RO)

Register 6.16. EFUSE_RD_REPEAT_DATA3_REG (0x003C)

31	30	29	14	13	12	11	10	9	8	7	6	5	4	3	2	1	0	
0	0		0x00	0	0	0x0	0	0	0x0	0	0	0	0	0	0	0	0	Reset

EFUSE_DIS_DOWNLOAD_MODE Represents whether all download modes are disabled.

- 1: Disabled
- 0: Enabled
- (RO)

EFUSE_DIS_DIRECT_BOOT Represents whether direct boot mode is disabled.

- 1: Disabled
- 0: Enabled
- (RO)

EFUSE_DIS_USB_SERIAL_JTAG_ROM_PRINT Represents whether print from USB-Serial-JTAG during ROM boot is disabled.

- 1: Disabled
- 0: Enabled
- (RO)

EFUSE_RPT4_RESERVED3_5 Reserved. (RO)

EFUSE_DIS_USB_SERIAL_JTAG_DOWNLOAD_MODE Represents whether the USB-Serial-JTAG download function is disabled.

- 1: Disabled
- 0: Enabled
- (RO)

EFUSE_ENABLE_SECURITY_DOWNLOAD Represents whether security download is enabled. Only UART is supported for download. Reading/writing RAM or registers is not supported (i.e. Stub download is not supported).

- 1: Enabled
- 0: Disabled
- (RO)

Continued on the next page...

Register 6.16. EFUSE_RD_REPEAT_DATA3_REG (0x003C)

Continued from the previous page...

EFUSE_UART_PRINT_CONTROL Represents the type of UART printing.

- 0: Force enable printing.
 - 1: Enable printing when GPIO8 is reset at low level.
 - 2: Enable printing when GPIO8 is reset at high level.
 - 3: Force disable printing.
- (RO)

EFUSE_RPT4_RESERVED3_4 Reserved. (RO)

EFUSE_RPT4_RESERVED3_3 Reserved. (RO)

EFUSE_RPT4_RESERVED3_2 Reserved. (RO)

EFUSE_RPT4_RESERVED3_1 Reserved. (RO)

EFUSE_FORCE_SEND_RESUME Represents whether ROM code is forced to send a resume command during SPI boot.

- 1: Forced.
 - 0: Not forced.
- (RO)

EFUSE_SECURE_VERSION Represents the security version used by ESP-IDF anti-rollback feature.

(RO)

EFUSE_SECURE_BOOT_DISABLE_FAST_WAKE Represents whether FAST VERIFY ON WAKE is disabled when Secure Boot is enabled.

- 1: Disabled
 - 0: Enabled
- (RO)

EFUSE_RPT4_RESERVED3_0 Reserved. (RO)

Register 6.17. EFUSE_RD_REPEAT_DATA4_REG (0x0040)

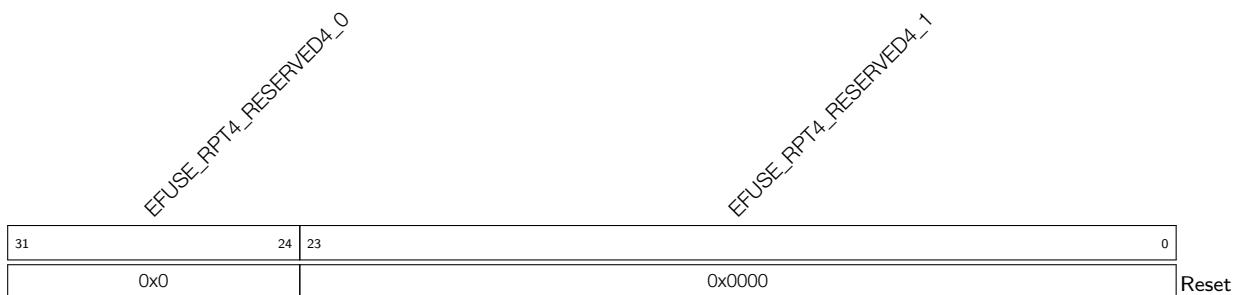

EFUSE_RPT4_RESERVED4_1 Reserved. (RO)

EFUSE_RPT4_RESERVED4_0 Reserved. (RO)

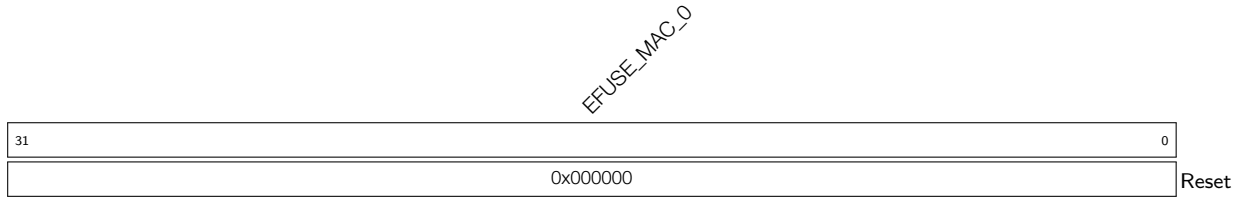
Register 6.18. EFUSE_RD_MAC_SPI_SYS_0_REG (0x0044)

EFUSE_MAC_0 Represents the low 32 bits of MAC address. (RO)

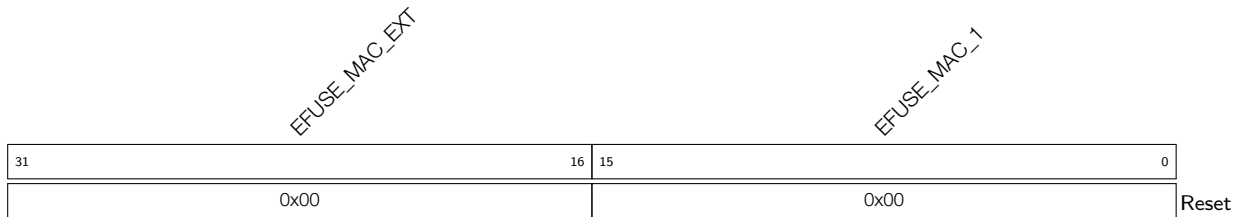
Register 6.19. EFUSE_RD_MAC_SPI_SYS_1_REG (0x0048)

EFUSE_MAC_1 Represents the high 16 bits of MAC address. (RO)

EFUSE_MAC_EXT Represents the extended bits of MAC address. (RO)

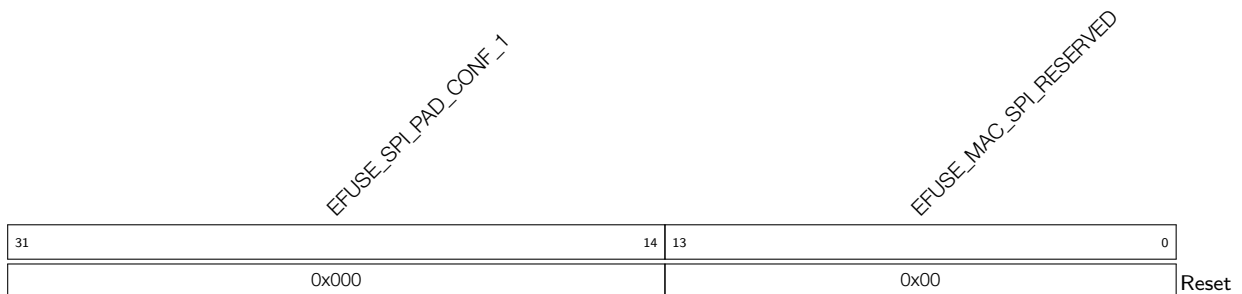
Register 6.20. EFUSE_RD_MAC_SPI_SYS_2_REG (0x004C)

EFUSE_MAC_SPI_RESERVED Reserved. (RO)

EFUSE_SPI_PAD_CONF_1 Represents the first part of SPI_PAD_CONF. (RO)

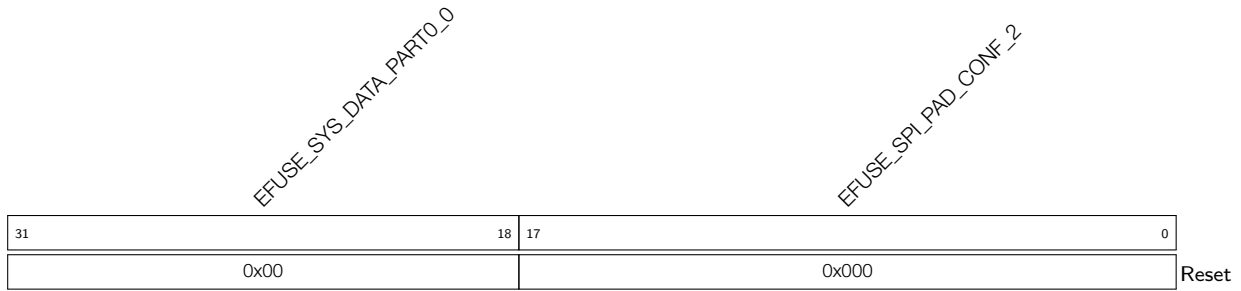
Register 6.21. EFUSE_RD_MAC_SPI_SYS_3_REG (0x0050)

EFUSE_SPI_PAD_CONF_2 Represents the second part of SPI_PAD_CONF. (RO)

EFUSE_SYS_DATA_PART0_0 Represents the first 14 bits of the zeroth part of system data. (RO)

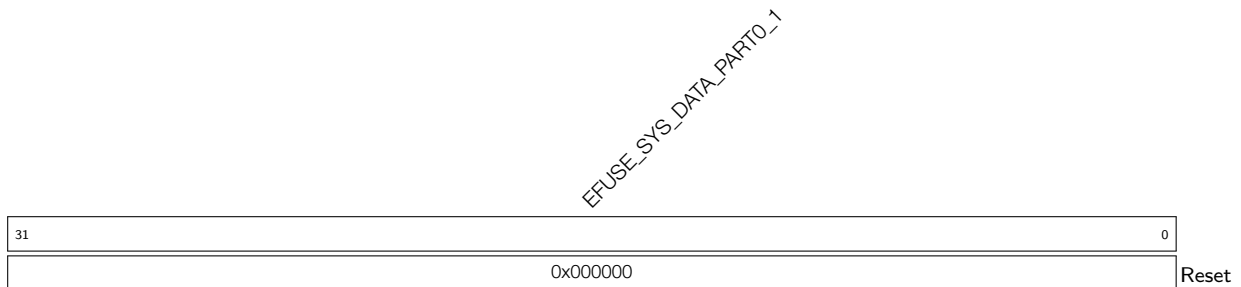
Register 6.22. EFUSE_RD_MAC_SPI_SYS_4_REG (0x0054)

EFUSE_SYS_DATA_PART0_1 Represents the first 32 bits of the zeroth part of system data. (RO)

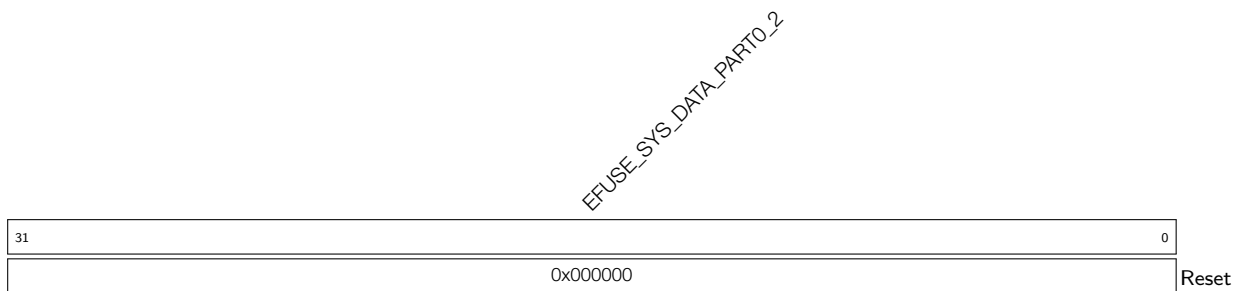
Register 6.23. EFUSE_RD_MAC_SPI_SYS_5_REG (0x0058)

EFUSE_SYS_DATA_PART0_2 Represents the second 32 bits of the zeroth part of system data. (RO)

Register 6.24. EFUSE_RD_SYS_PART1_DATA0_REG (0x005C)

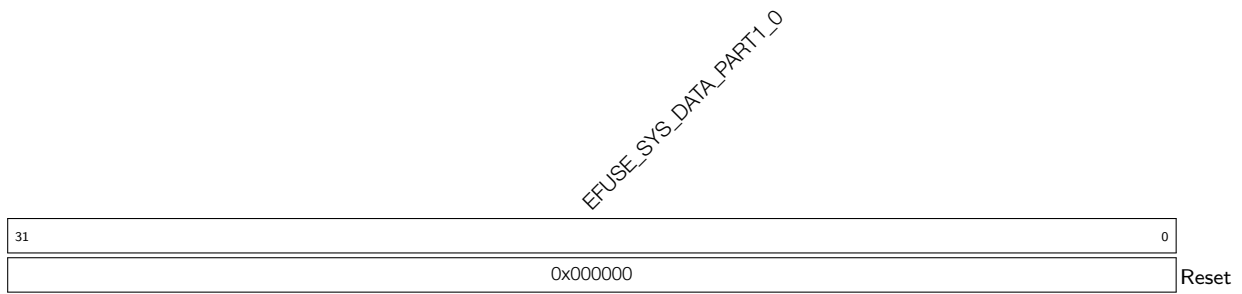

EFUSE_SYS_DATA_PART1_0 Represents the zeroth 32 bits of the first part of system data. (RO)

Register 6.25. EFUSE_RD_SYS_PART1_DATA1_REG (0x0060)

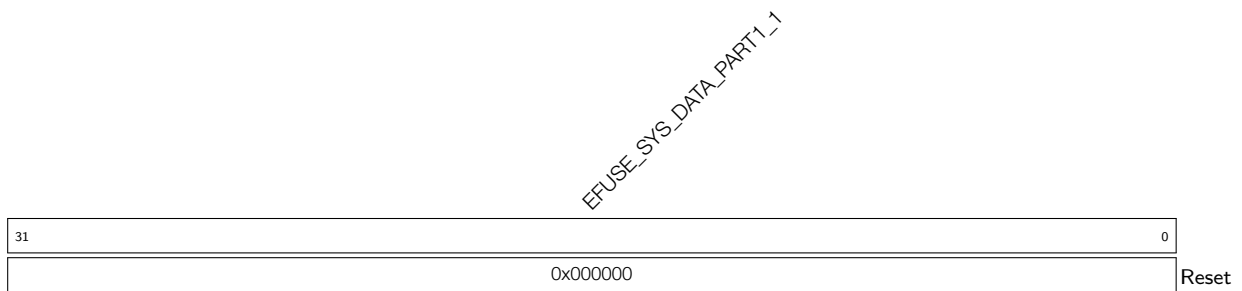

EFUSE_SYS_DATA_PART1_1 Represents the first 32 bits of the first part of system data. (RO)

Register 6.26. EFUSE_RD_SYS_PART1_DATA2_REG (0x0064)

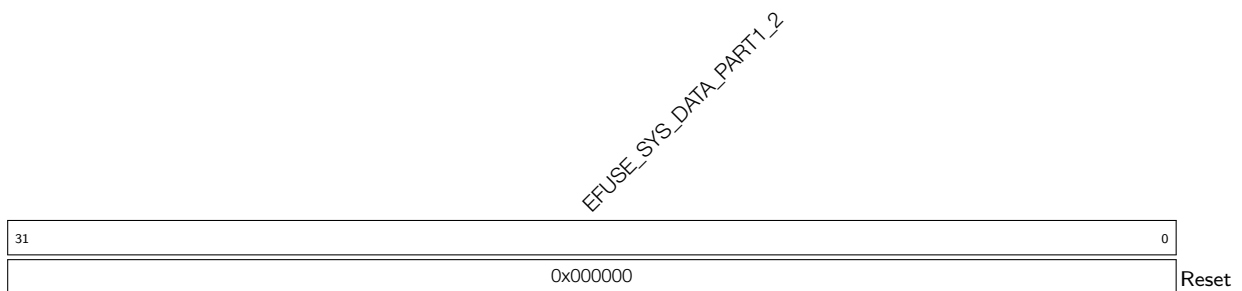

EFUSE_SYS_DATA_PART1_2 Represents the second 32 bits of the first part of system data. (RO)

Register 6.27. EFUSE_RD_SYS_PART1_DATA3_REG (0x0068)

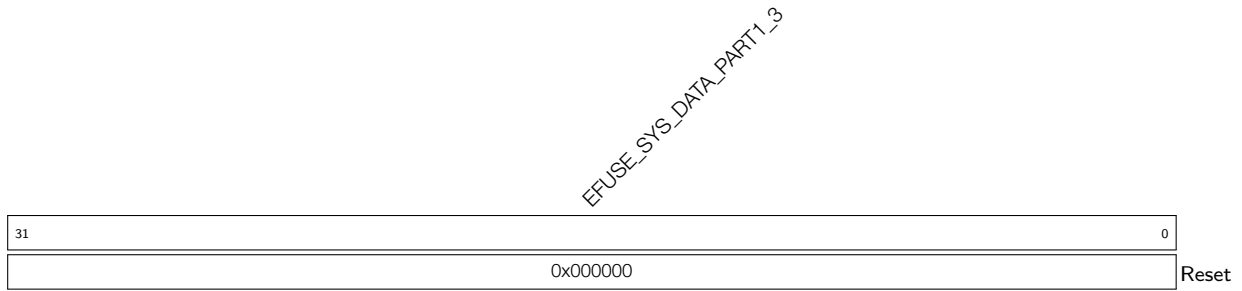

EFUSE_SYS_DATA_PART1_3 Represents the third 32 bits of the first part of system data. (RO)

Register 6.28. EFUSE_RD_SYS_PART1_DATA4_REG (0x006C)

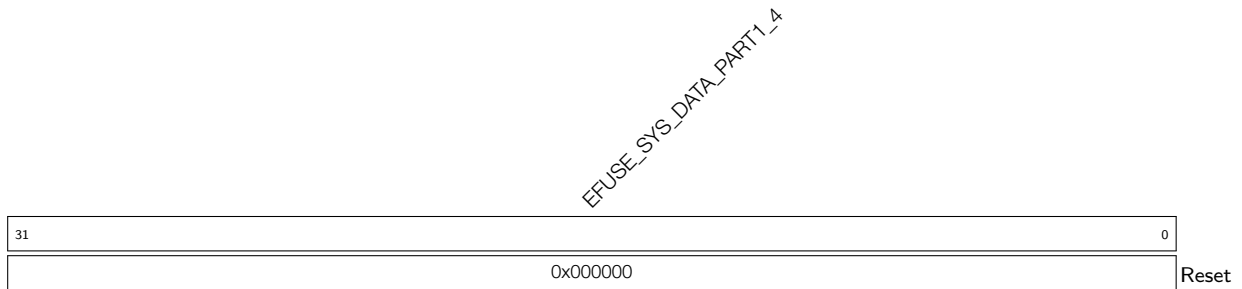

EFUSE_SYS_DATA_PART1_4 Represents the fourth 32 bits of the first part of system data. (RO)

Register 6.29. EFUSE_RD_SYS_PART1_DATA5_REG (0x0070)

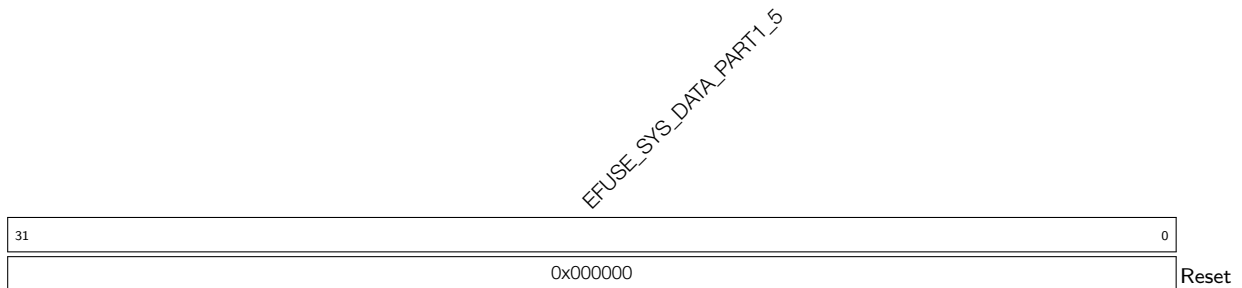

EFUSE_SYS_DATA_PART1_5 Represents the fifth 32 bits of the first part of system data. (RO)

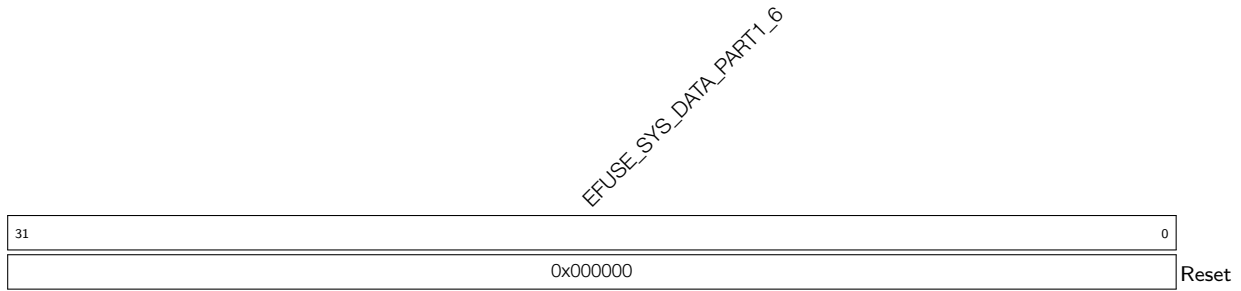
Register 6.30. EFUSE_RD_SYS_PART1_DATA6_REG (0x0074)

EFUSE_SYS_DATA_PART1_6 Represents the sixth 32 bits of the first part of system data. (RO)

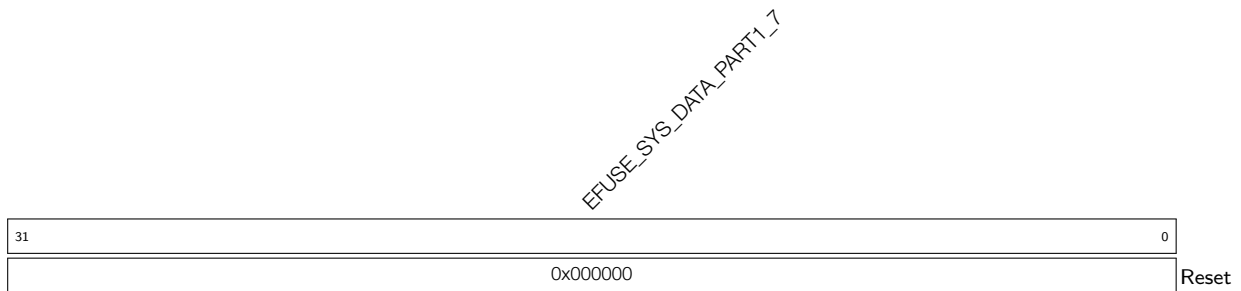
Register 6.31. EFUSE_RD_SYS_PART1_DATA7_REG (0x0078)

EFUSE_SYS_DATA_PART1_7 Represents the seventh 32 bits of the first part of system data. (RO)

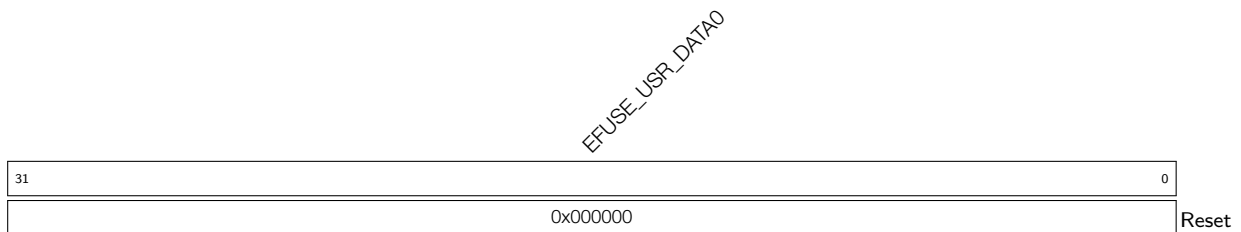
Register 6.32. EFUSE_RD_USR_DATA0_REG (0x007C)

EFUSE_USR_DATA0 Represents the zeroth 32 bits of BLOCK3 (user). (RO)

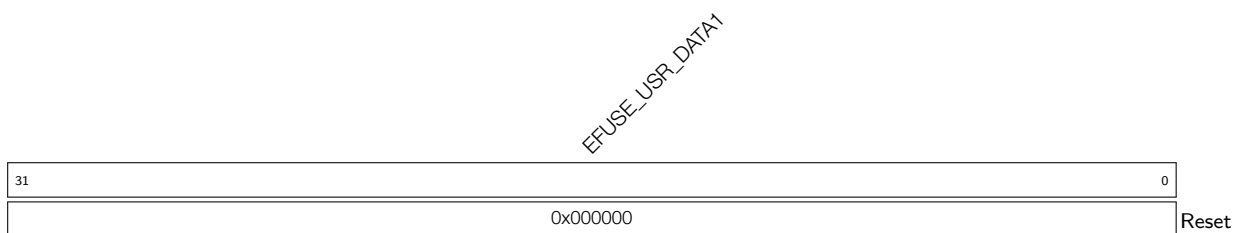
Register 6.33. EFUSE_RD_USR_DATA1_REG (0x0080)

EFUSE_USR_DATA1 Represents the first 32 bits of BLOCK3 (user). (RO)

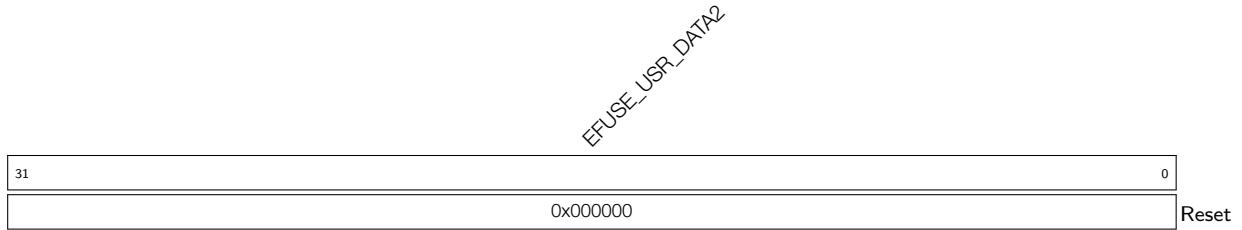
Register 6.34. EFUSE_RD_USR_DATA2_REG (0x0084)

EFUSE_USR_DATA2 Represents the second 32 bits of BLOCK3 (user). (RO)

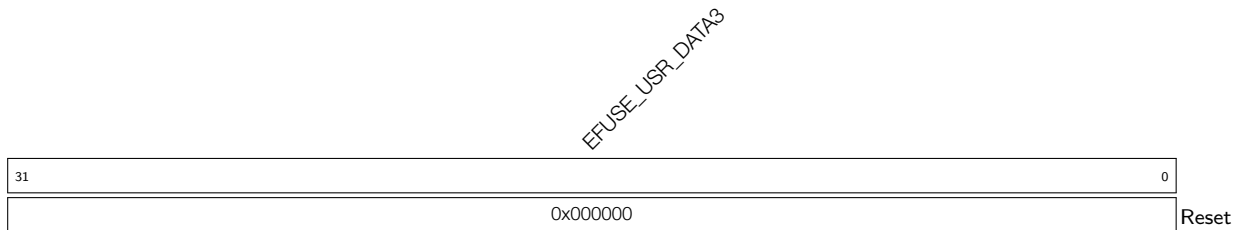
Register 6.35. EFUSE_RD_USR_DATA3_REG (0x0088)

EFUSE_USR_DATA3 Represents the third 32 bits of BLOCK3 (user). (RO)

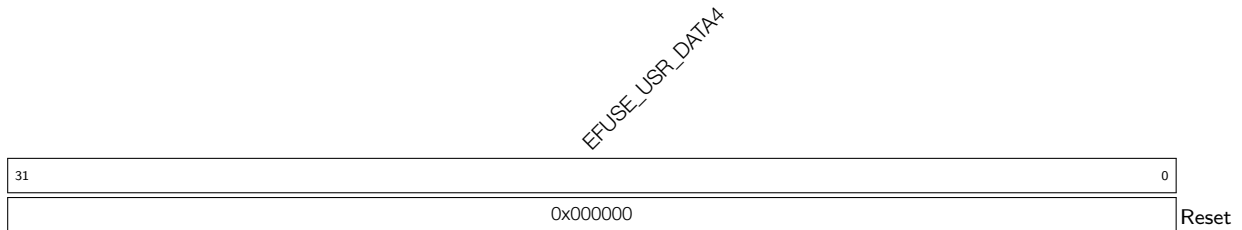
Register 6.36. EFUSE_RD_USR_DATA4_REG (0x008C)

EFUSE_USR_DATA4 Represents the fourth 32 bits of BLOCK3 (user). (RO)

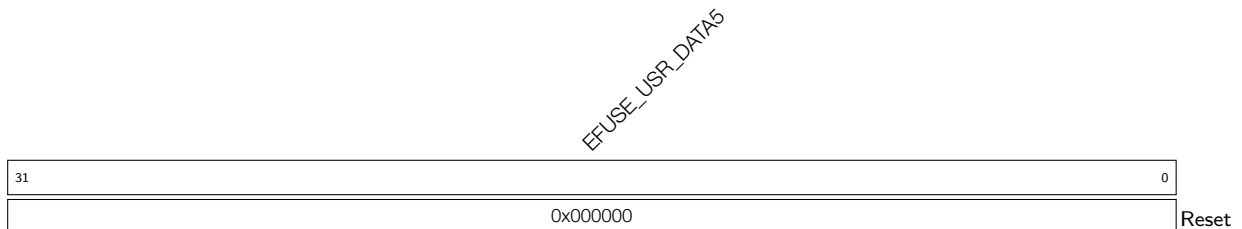
Register 6.37. EFUSE_RD_USR_DATA5_REG (0x0090)

EFUSE_USR_DATA5 Represents the fifth 32 bits of BLOCK3 (user). (RO)

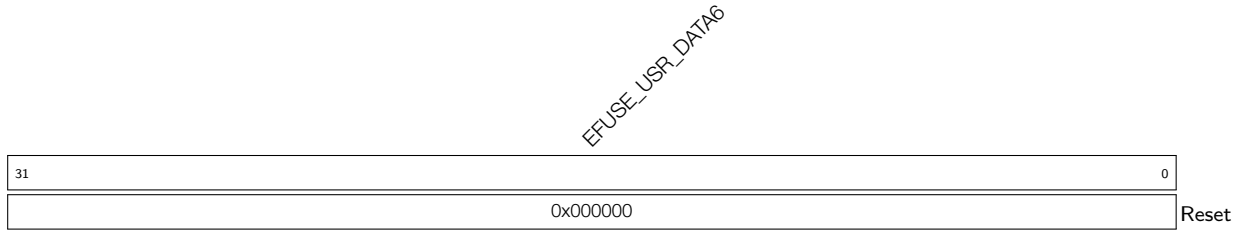
Register 6.38. EFUSE_RD_USR_DATA6_REG (0x0094)

EFUSE_USR_DATA6 Represents the sixth 32 bits of BLOCK3 (user). (RO)

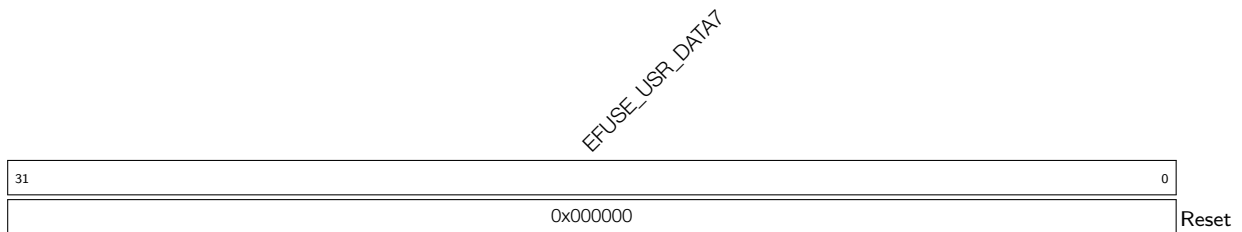
Register 6.39. EFUSE_RD_USR_DATA7_REG (0x0098)

EFUSE_USR_DATA7 Represents the seventh 32 bits of BLOCK3 (user). (RO)

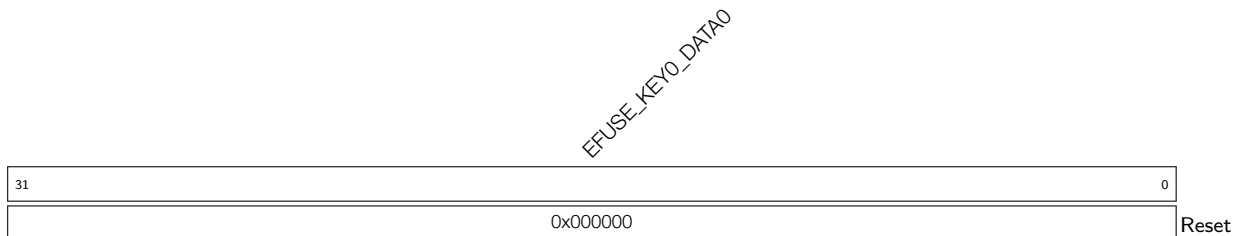
Register 6.40. EFUSE_RD_KEY0_DATA0_REG (0x009C)

EFUSE_KEY0_DATA0 Represents the zeroth 32 bits of KEY0. (RO)

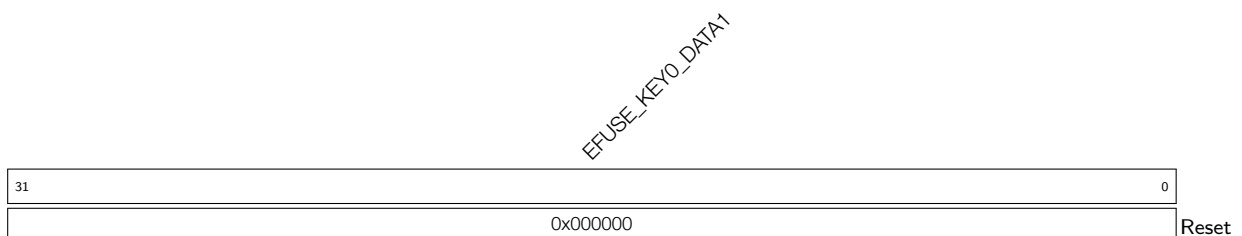
Register 6.41. EFUSE_RD_KEY0_DATA1_REG (0x00A0)

EFUSE_KEY0_DATA1 Represents the first 32 bits of KEY0. (RO)

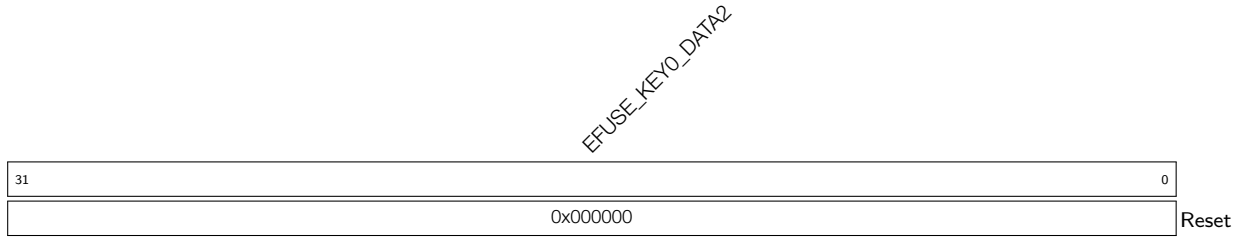
Register 6.42. EFUSE_RD_KEY0_DATA2_REG (0x00A4)

EFUSE_KEY0_DATA2 Represents the second 32 bits of KEY0. (RO)

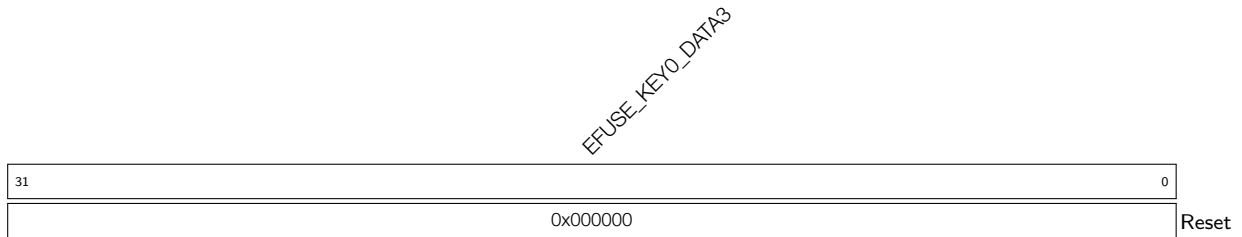
Register 6.43. EFUSE_RD_KEY0_DATA3_REG (0x00A8)

EFUSE_KEY0_DATA3 Represents the third 32 bits of KEY0. (RO)

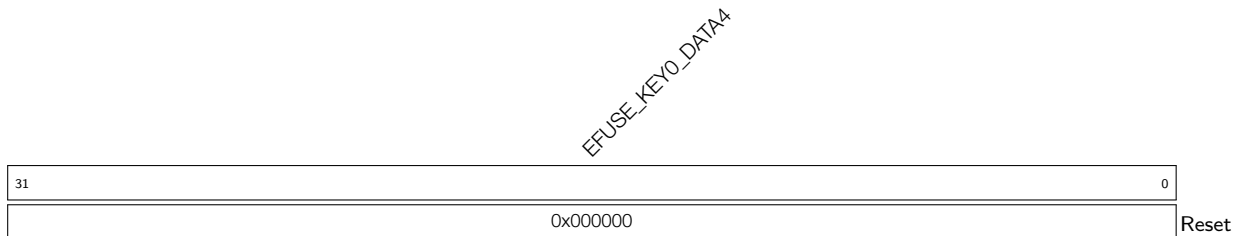
Register 6.44. EFUSE_RD_KEY0_DATA4_REG (0x00AC)

EFUSE_KEY0_DATA4 Represents the fourth 32 bits of KEY0. (RO)

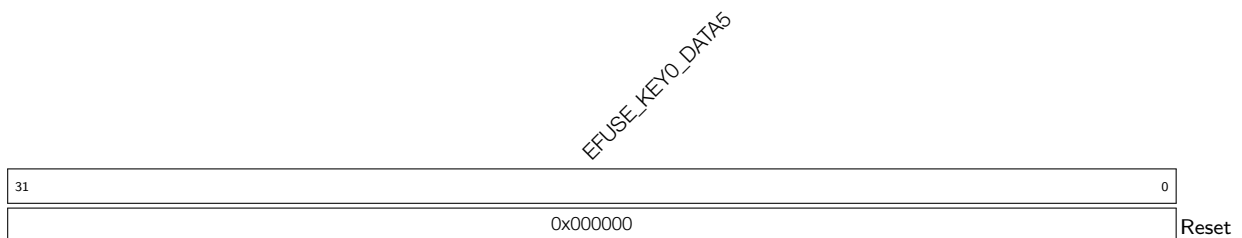
Register 6.45. EFUSE_RD_KEY0_DATA5_REG (0x00B0)

EFUSE_KEY0_DATA5 Represents the fifth 32 bits of KEY0. (RO)

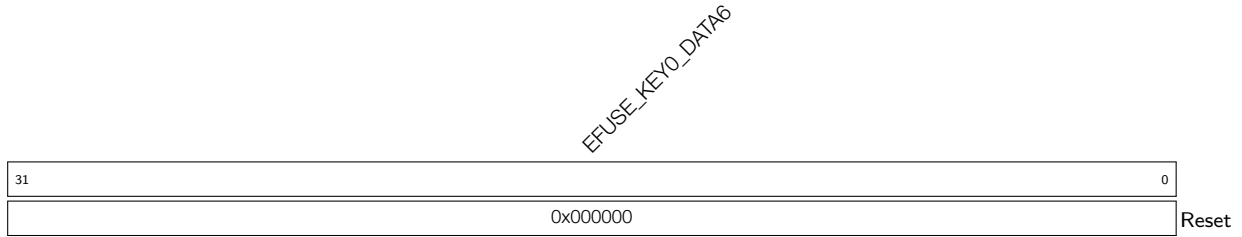
Register 6.46. EFUSE_RD_KEY0_DATA6_REG (0x00B4)

EFUSE_KEY0_DATA6 Represents the sixth 32 bits of KEY0. (RO)

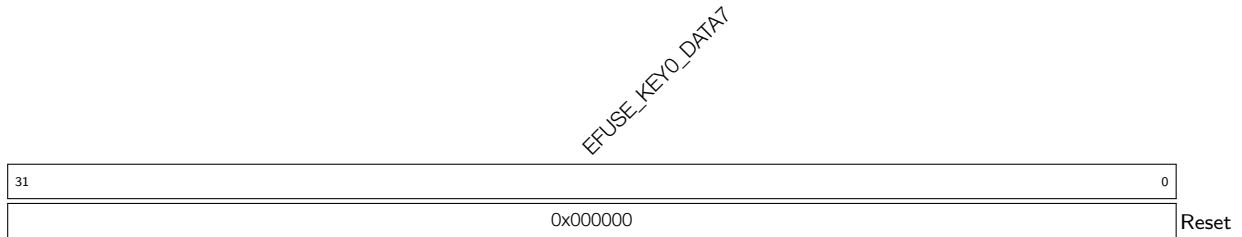
Register 6.47. EFUSE_RD_KEY0_DATA7_REG (0x00B8)

EFUSE_KEY0_DATA7 Represents the seventh 32 bits of KEY0. (RO)

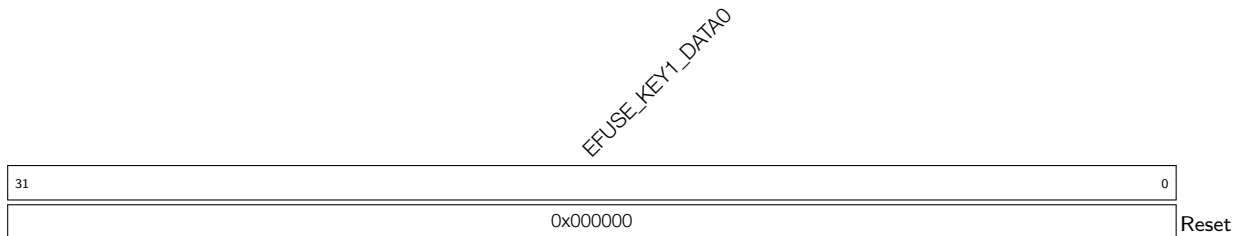
Register 6.48. EFUSE_RD_KEY1_DATA0_REG (0x00BC)

EFUSE_KEY1_DATA0 Represents the zeroth 32 bits of KEY1. (RO)

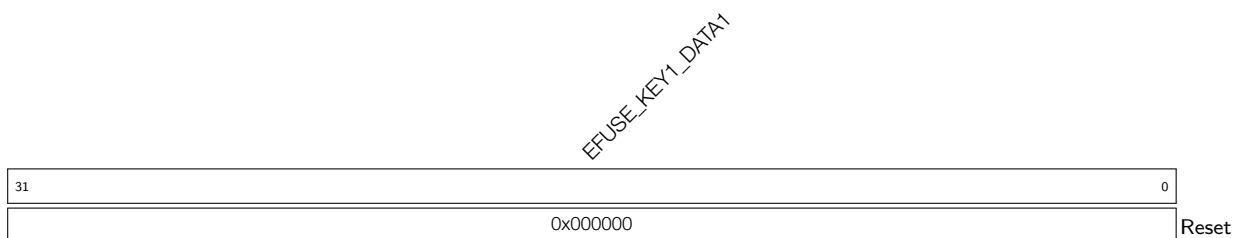
Register 6.49. EFUSE_RD_KEY1_DATA1_REG (0x00C0)

EFUSE_KEY1_DATA1 Represents the first 32 bits of KEY1. (RO)

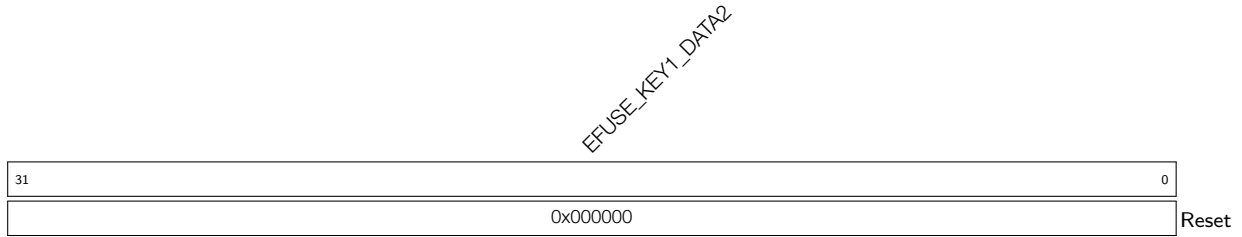
Register 6.50. EFUSE_RD_KEY1_DATA2_REG (0x00C4)

EFUSE_KEY1_DATA2 Represents the second 32 bits of KEY1. (RO)

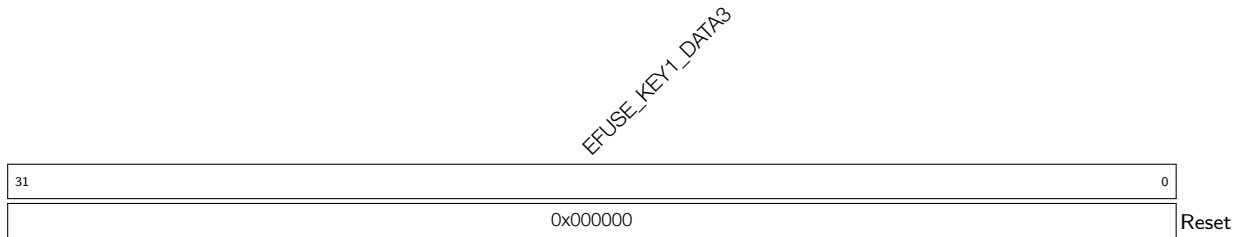
Register 6.51. EFUSE_RD_KEY1_DATA3_REG (0x00C8)

EFUSE_KEY1_DATA3 Represents the third 32 bits of KEY1. (RO)

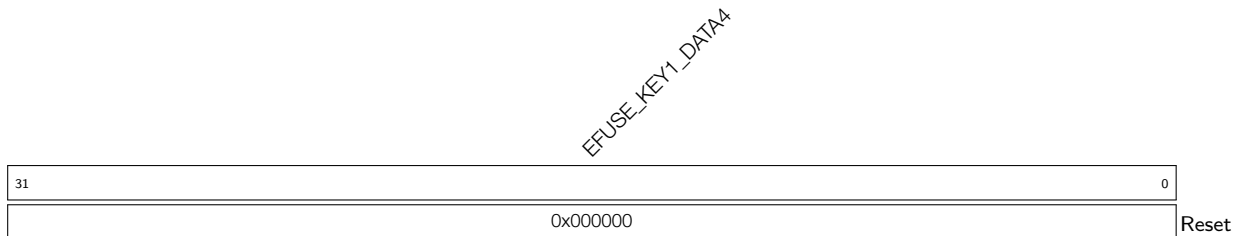
Register 6.52. EFUSE_RD_KEY1_DATA4_REG (0x00CC)

EFUSE_KEY1_DATA4 Represents the fourth 32 bits of KEY1. (RO)

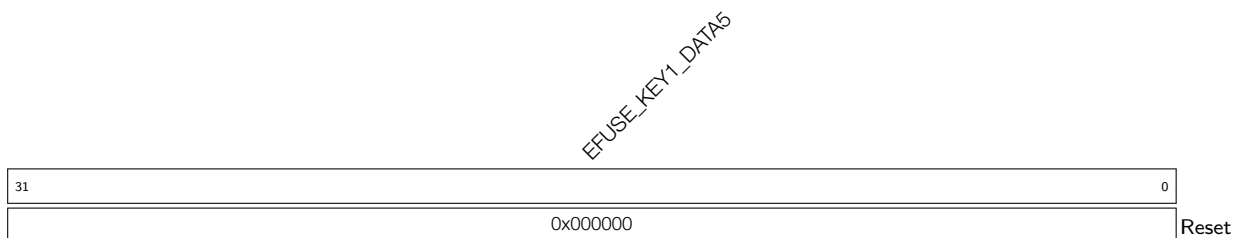
Register 6.53. EFUSE_RD_KEY1_DATA5_REG (0x00D0)

EFUSE_KEY1_DATA5 Represents the fifth 32 bits of KEY1. (RO)

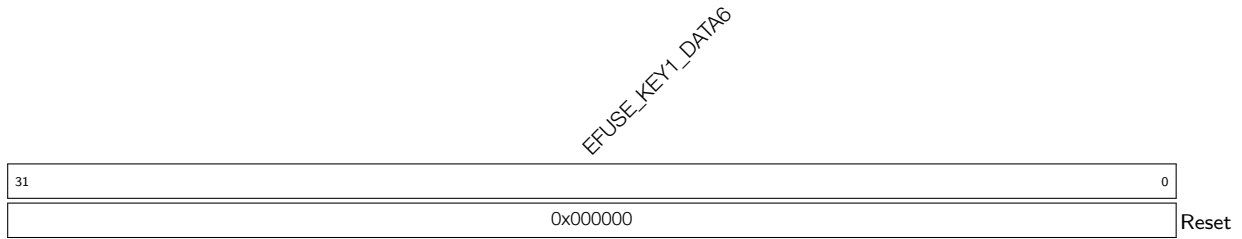
Register 6.54. EFUSE_RD_KEY1_DATA6_REG (0x00D4)

EFUSE_KEY1_DATA6 Represents the sixth 32 bits of KEY1. (RO)

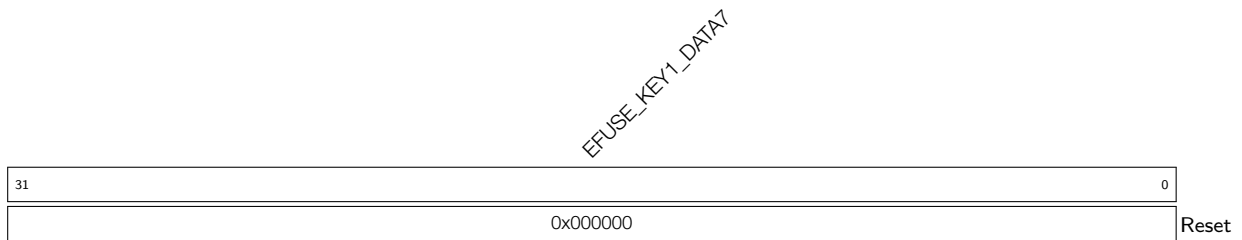
Register 6.55. EFUSE_RD_KEY1_DATA7_REG (0x00D8)

EFUSE_KEY1_DATA7 Represents the seventh 32 bits of KEY1. (RO)

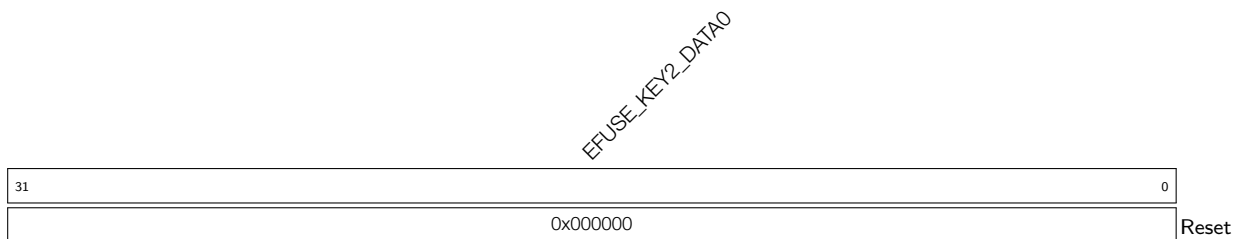
Register 6.56. EFUSE_RD_KEY2_DATA0_REG (0x00DC)

EFUSE_KEY2_DATA0 Represents the zeroth 32 bits of KEY2. (RO)

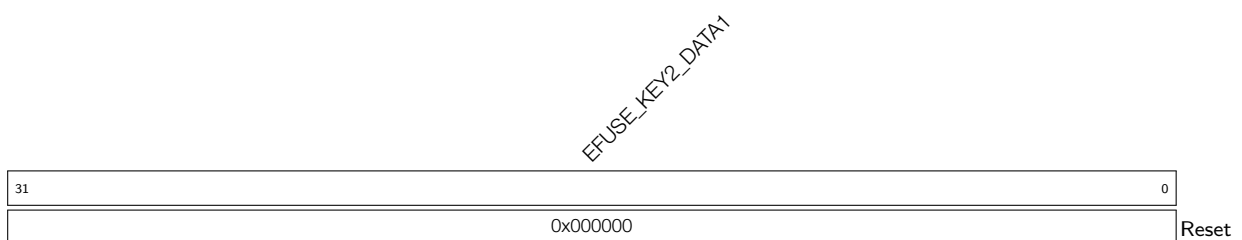
Register 6.57. EFUSE_RD_KEY2_DATA1_REG (0x00E0)

EFUSE_KEY2_DATA1 Represents the first 32 bits of KEY2. (RO)

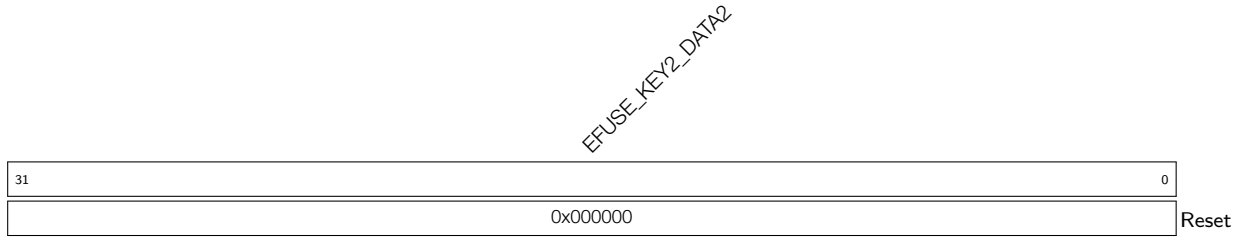
Register 6.58. EFUSE_RD_KEY2_DATA2_REG (0x00E4)

EFUSE_KEY2_DATA2 Represents the second 32 bits of KEY2. (RO)

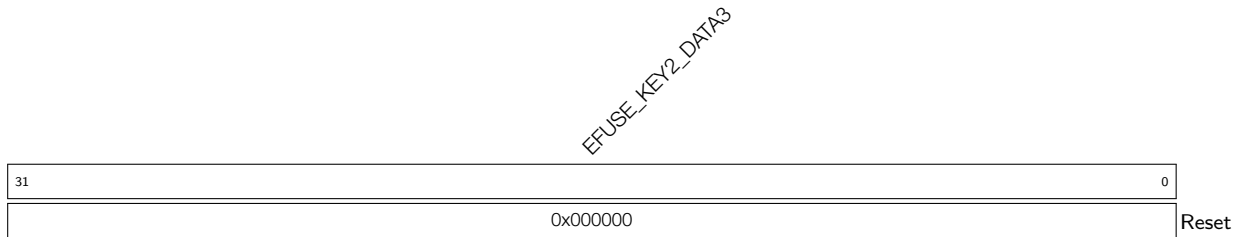
Register 6.59. EFUSE_RD_KEY2_DATA3_REG (0x00E8)

EFUSE_KEY2_DATA3 Represents the third 32 bits of KEY2. (RO)

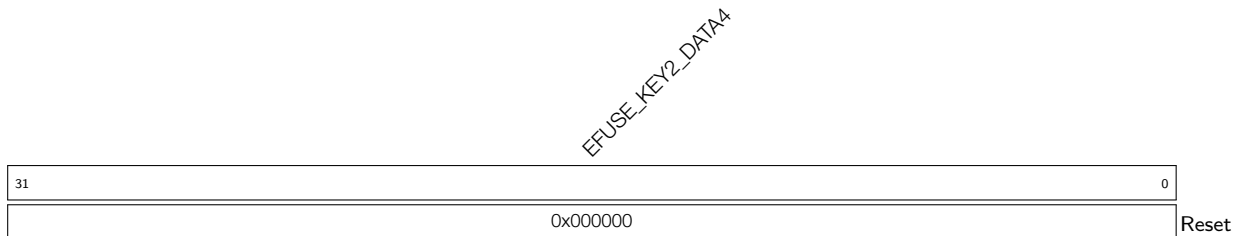
Register 6.60. EFUSE_RD_KEY2_DATA4_REG (0x00EC)

EFUSE_KEY2_DATA4 Represents the fourth 32 bits of KEY2. (RO)

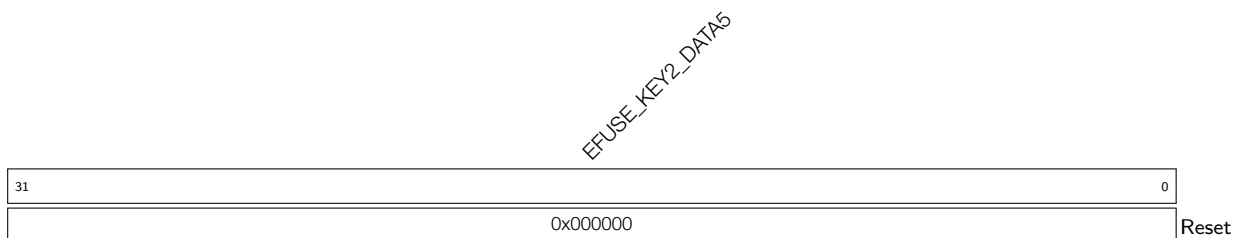
Register 6.61. EFUSE_RD_KEY2_DATA5_REG (0x00F0)

EFUSE_KEY2_DATA5 Represents the fifth 32 bits of KEY2. (RO)

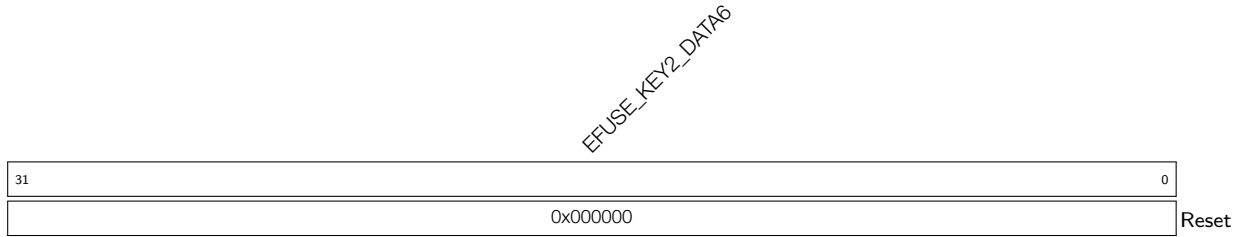
Register 6.62. EFUSE_RD_KEY2_DATA6_REG (0x00F4)

EFUSE_KEY2_DATA6 Represents the sixth 32 bits of KEY2. (RO)

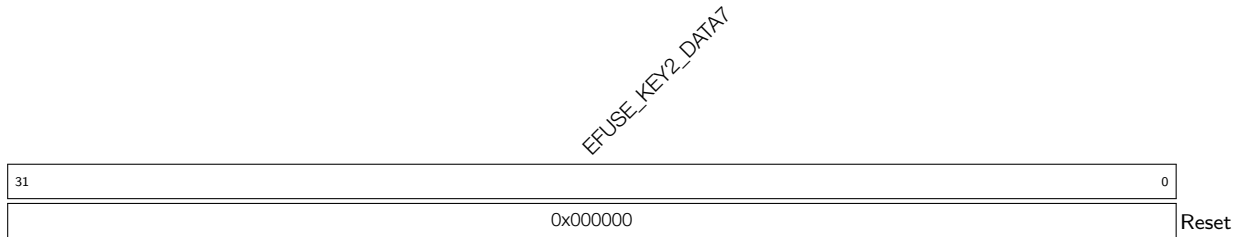
Register 6.63. EFUSE_RD_KEY2_DATA7_REG (0x00F8)

EFUSE_KEY2_DATA7 Represents the seventh 32 bits of KEY2. (RO)

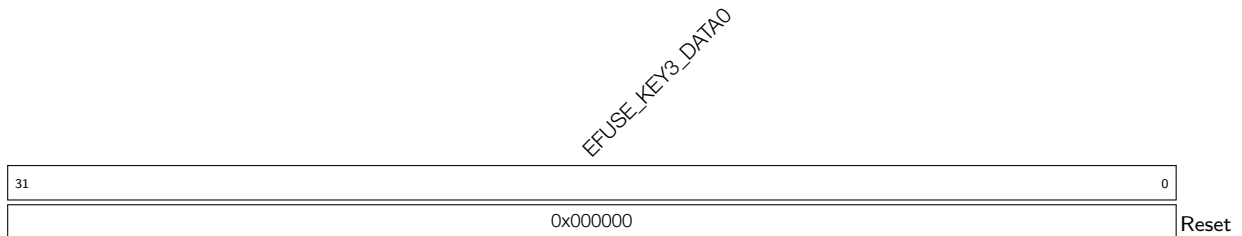
Register 6.64. EFUSE_RD_KEY3_DATA0_REG (0x00FC)

EFUSE_KEY3_DATA0 Represents the zeroth 32 bits of KEY3. (RO)

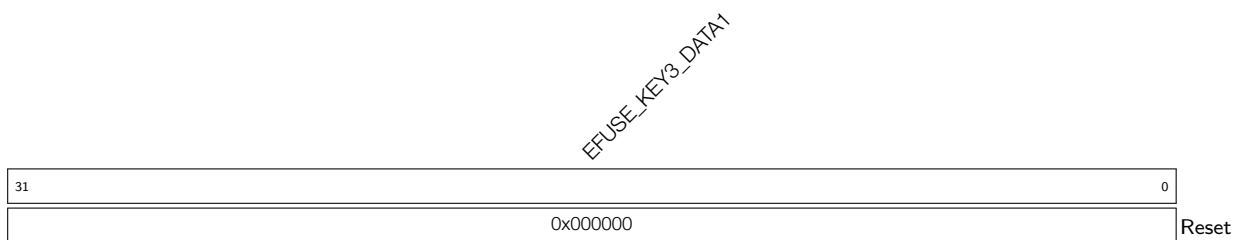
Register 6.65. EFUSE_RD_KEY3_DATA1_REG (0x0100)

EFUSE_KEY3_DATA1 Represents the first 32 bits of KEY3. (RO)

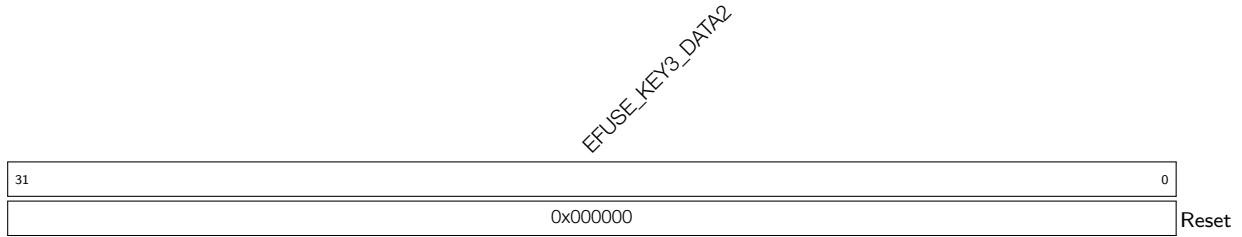
Register 6.66. EFUSE_RD_KEY3_DATA2_REG (0x0104)

EFUSE_KEY3_DATA2 Represents the second 32 bits of KEY3. (RO)

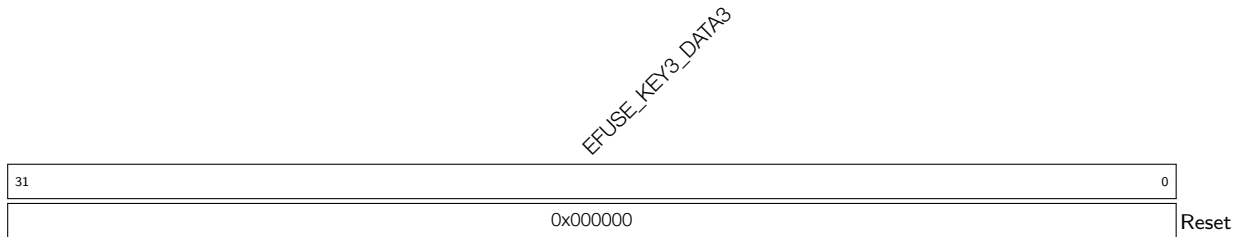
Register 6.67. EFUSE_RD_KEY3_DATA3_REG (0x0108)

EFUSE_KEY3_DATA3 Represents the third 32 bits of KEY3. (RO)

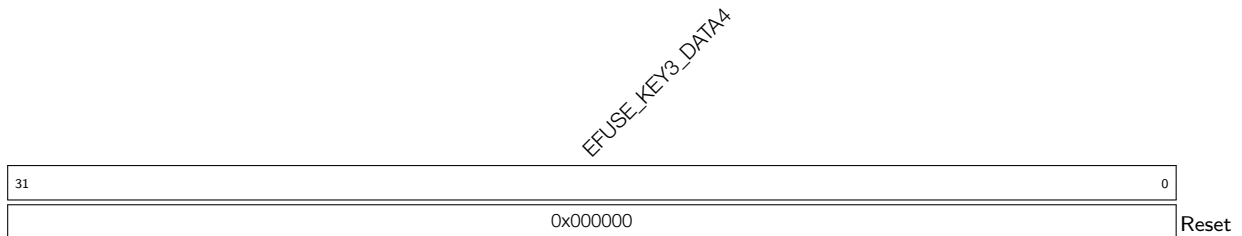
Register 6.68. EFUSE_RD_KEY3_DATA4_REG (0x010C)

EFUSE_KEY3_DATA4 Represents the fourth 32 bits of KEY3. (RO)

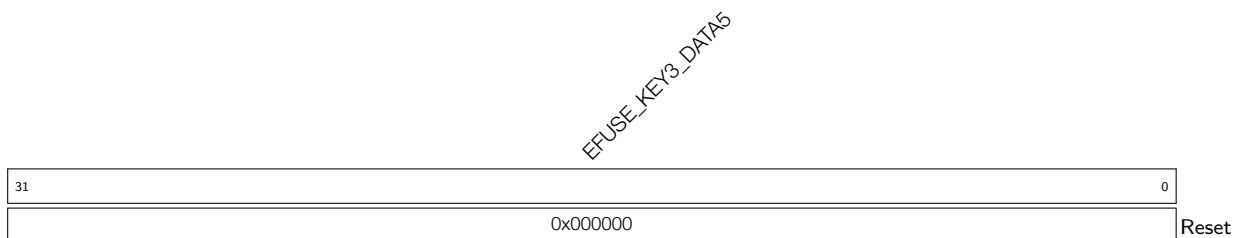
Register 6.69. EFUSE_RD_KEY3_DATA5_REG (0x0110)

EFUSE_KEY3_DATA5 Represents the fifth 32 bits of KEY3. (RO)

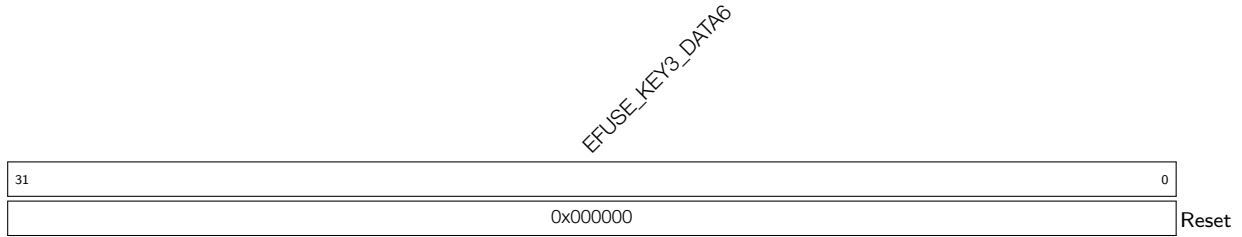
Register 6.70. EFUSE_RD_KEY3_DATA6_REG (0x0114)

EFUSE_KEY3_DATA6 Represents the sixth 32 bits of KEY3. (RO)

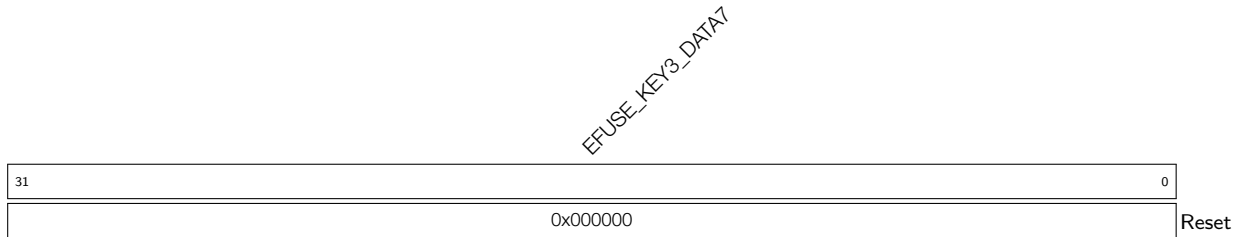
Register 6.71. EFUSE_RD_KEY3_DATA7_REG (0x0118)

EFUSE_KEY3_DATA7 Represents the seventh 32 bits of KEY3. (RO)

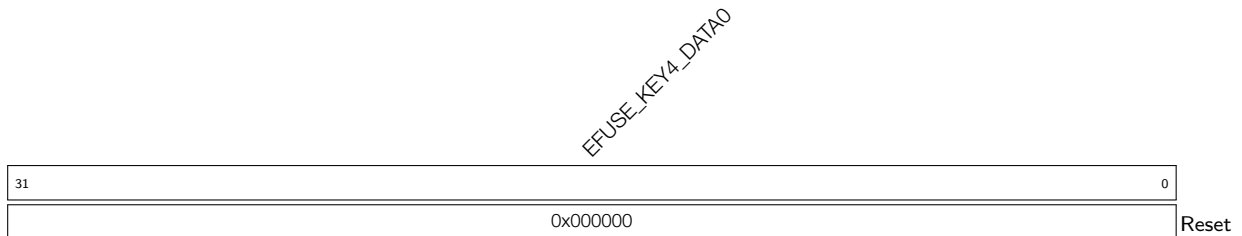
Register 6.72. EFUSE_RD_KEY4_DATA0_REG (0x011C)

EFUSE_KEY4_DATA0 Represents the zeroth 32 bits of KEY4. (RO)

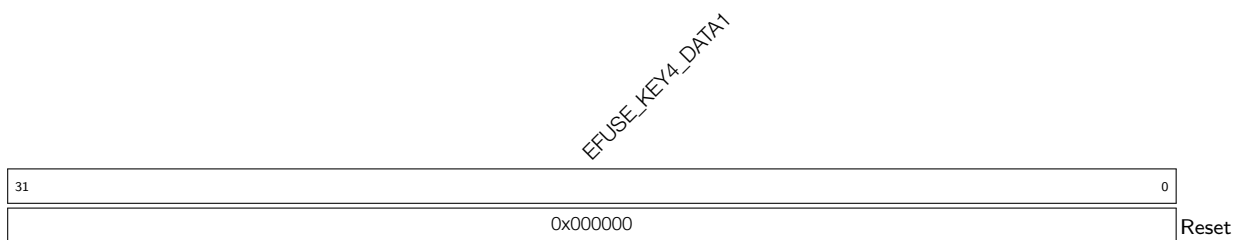
Register 6.73. EFUSE_RD_KEY4_DATA1_REG (0x0120)

EFUSE_KEY4_DATA1 Represents the first 32 bits of KEY4. (RO)

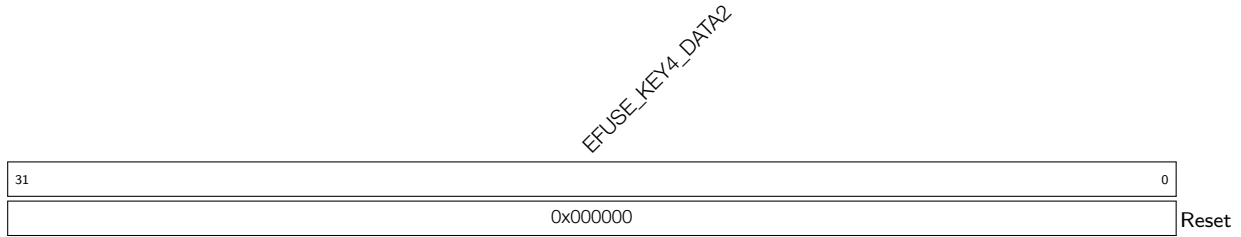
Register 6.74. EFUSE_RD_KEY4_DATA2_REG (0x0124)

EFUSE_KEY4_DATA2 Represents the second 32 bits of KEY4. (RO)

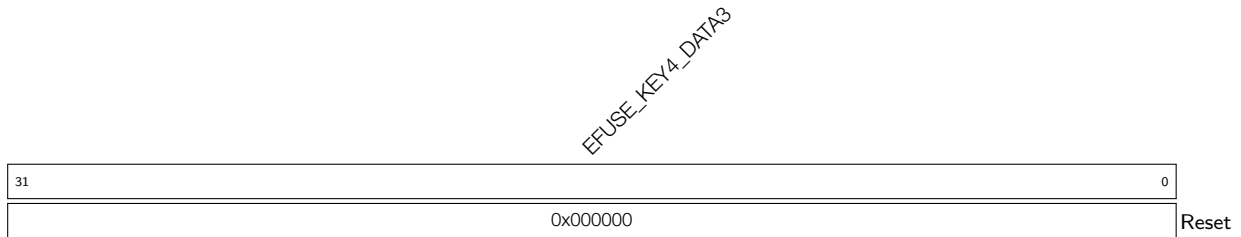
Register 6.75. EFUSE_RD_KEY4_DATA3_REG (0x0128)

EFUSE_KEY4_DATA3 Represents the third 32 bits of KEY4. (RO)

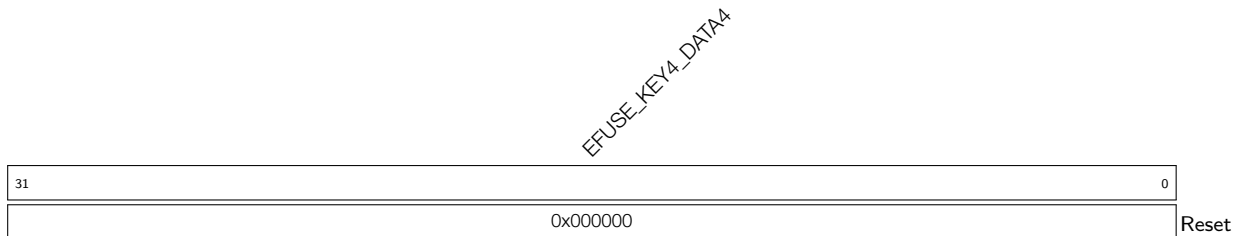
Register 6.76. EFUSE_RD_KEY4_DATA4_REG (0x012C)

EFUSE_KEY4_DATA4 Represents the fourth 32 bits of KEY4. (RO)

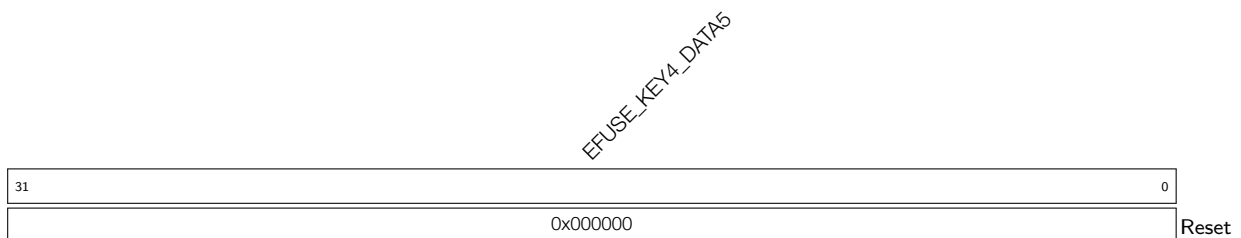
Register 6.77. EFUSE_RD_KEY4_DATA5_REG (0x0130)

EFUSE_KEY4_DATA5 Represents the fifth 32 bits of KEY4. (RO)

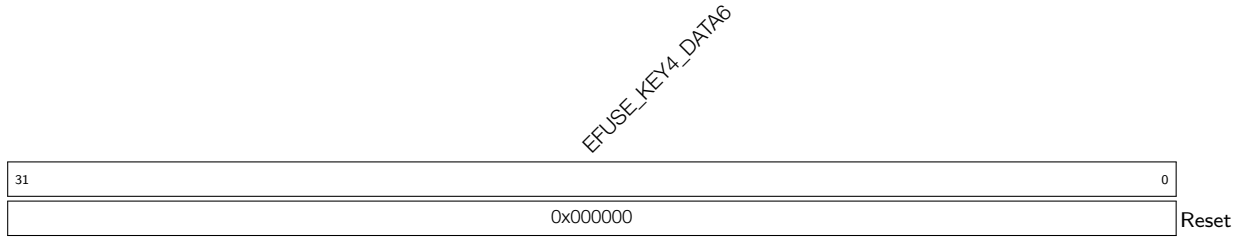
Register 6.78. EFUSE_RD_KEY4_DATA6_REG (0x0134)

EFUSE_KEY4_DATA6 Represents the sixth 32 bits of KEY4. (RO)

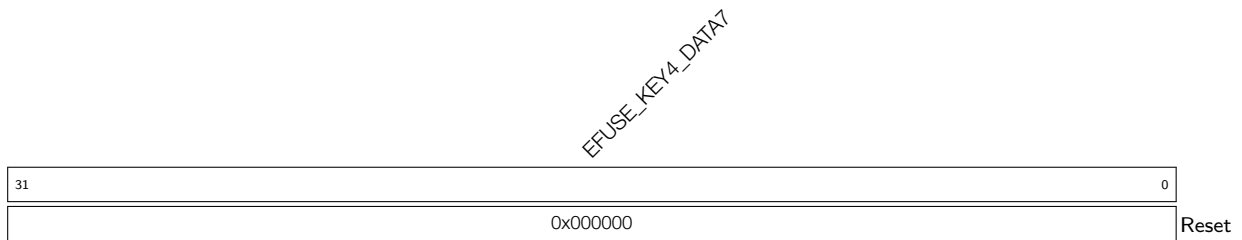
Register 6.79. EFUSE_RD_KEY4_DATA7_REG (0x0138)

EFUSE_KEY4_DATA7 Represents the seventh 32 bits of KEY4. (RO)

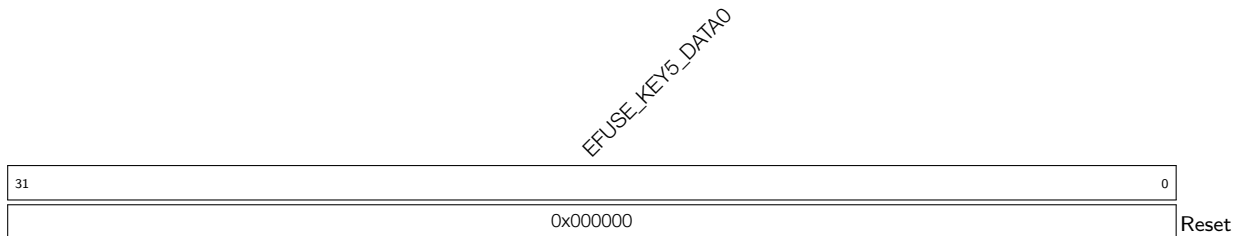
Register 6.80. EFUSE_RD_KEY5_DATA0_REG (0x013C)

EFUSE_KEY5_DATA0 Represents the zeroth 32 bits of KEY5. (RO)

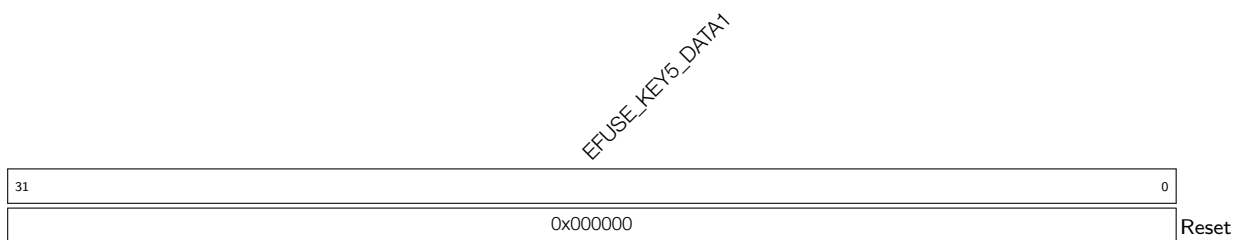
Register 6.81. EFUSE_RD_KEY5_DATA1_REG (0x0140)

EFUSE_KEY5_DATA1 Represents the first 32 bits of KEY5. (RO)

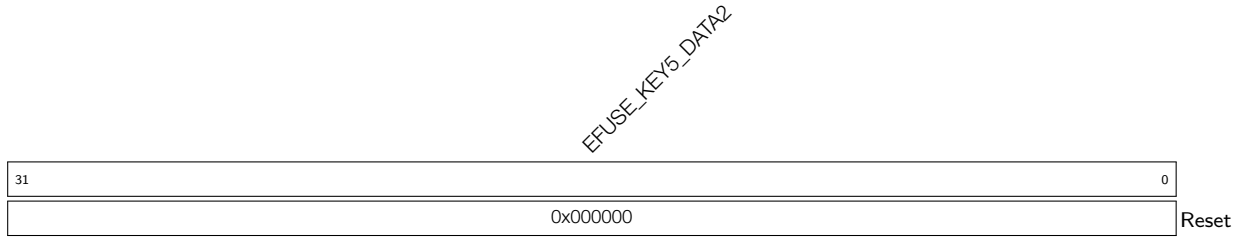
Register 6.82. EFUSE_RD_KEY5_DATA2_REG (0x0144)

EFUSE_KEY5_DATA2 Represents the second 32 bits of KEY5. (RO)

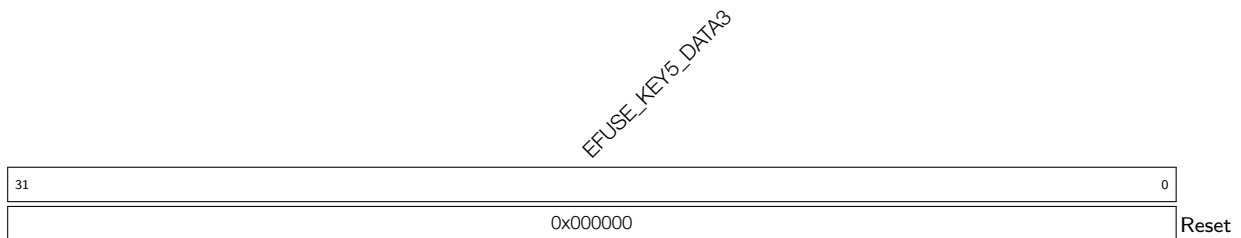
Register 6.83. EFUSE_RD_KEY5_DATA3_REG (0x0148)

EFUSE_KEY5_DATA3 Represents the third 32 bits of KEY5. (RO)

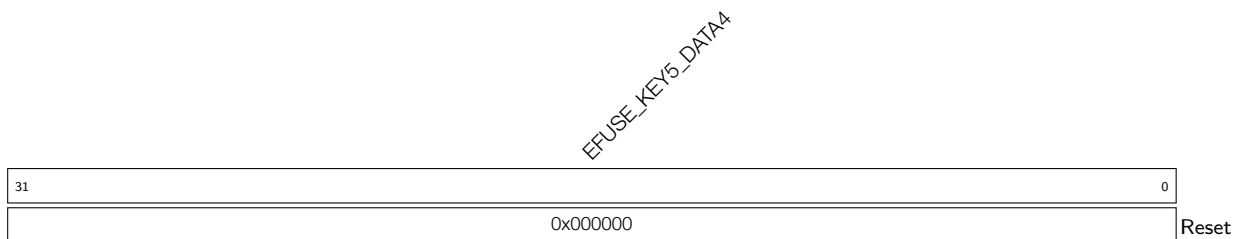
Register 6.84. EFUSE_RD_KEY5_DATA4_REG (0x014C)

EFUSE_KEY5_DATA4 Represents the fourth 32 bits of KEY5. (RO)

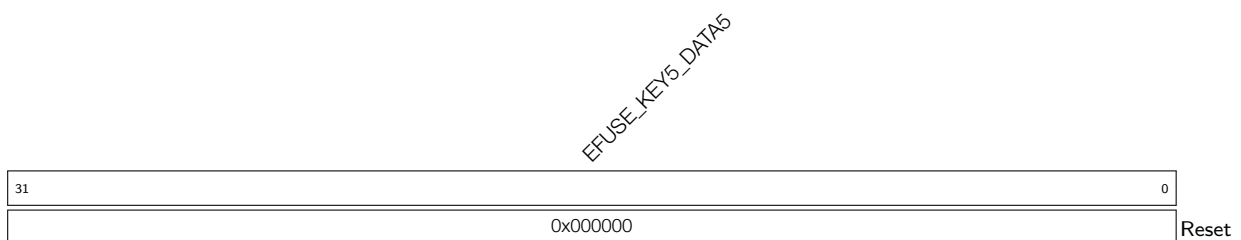
Register 6.85. EFUSE_RD_KEY5_DATA5_REG (0x0150)

EFUSE_KEY5_DATA5 Represents the fifth 32 bits of KEY5. (RO)

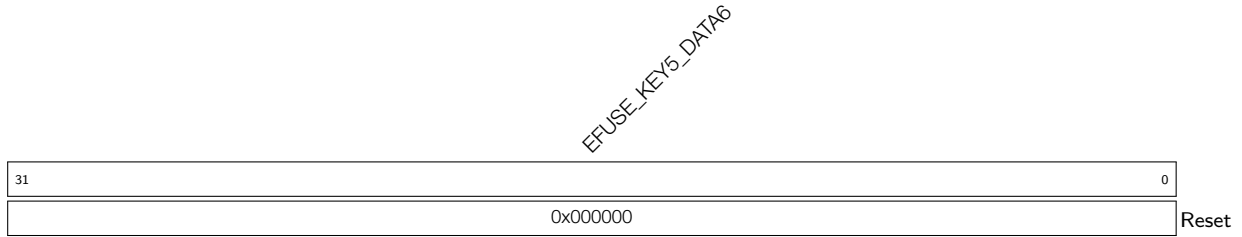
Register 6.86. EFUSE_RD_KEY5_DATA6_REG (0x0154)

EFUSE_KEY5_DATA6 Represents the sixth 32 bits of KEY5. (RO)

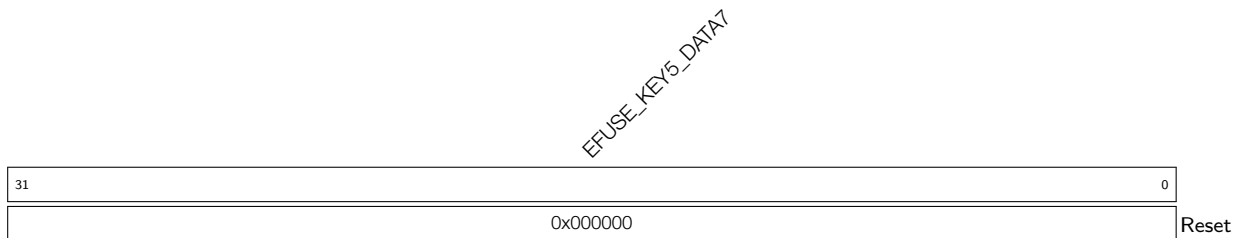
Register 6.87. EFUSE_RD_KEY5_DATA7_REG (0x0158)

EFUSE_KEY5_DATA7 Represents the seventh 32 bits of KEY5. (RO)

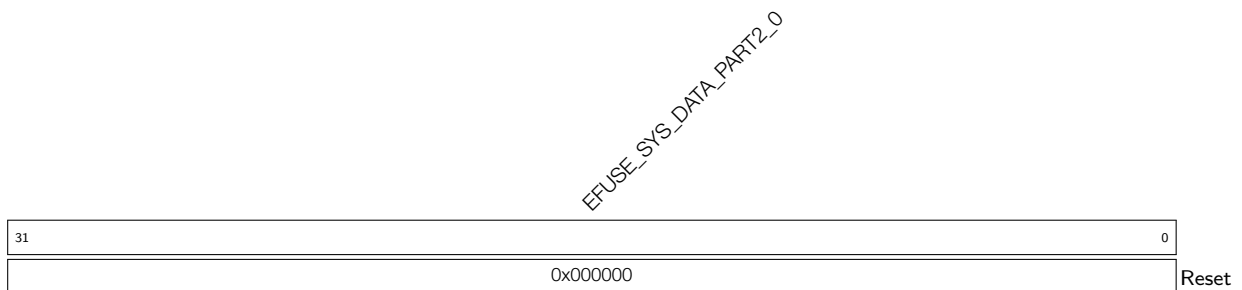
Register 6.88. EFUSE_RD_SYS_PART2_DATA0_REG (0x015C)

EFUSE_SYS_DATA_PART2_0 Represents the 0th 32 bits of the 2nd part of system data. (RO)

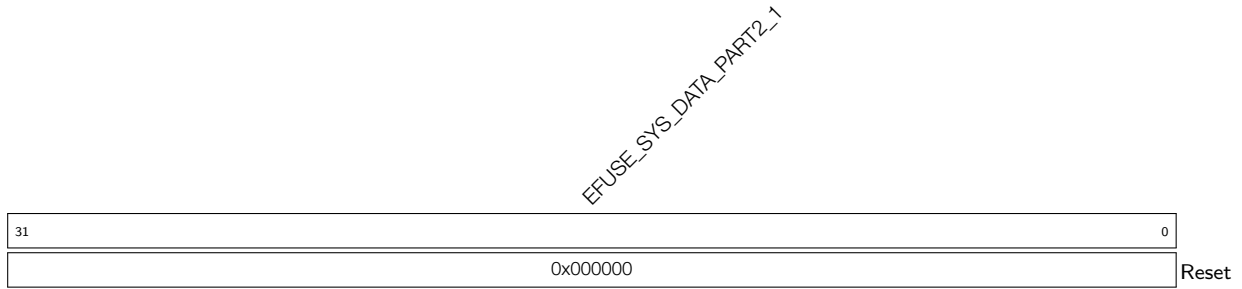
Register 6.89. EFUSE_RD_SYS_PART2_DATA1_REG (0x0160)

EFUSE_SYS_DATA_PART2_1 Represents the 1st 32 bits of the 2nd part of system data. (RO)

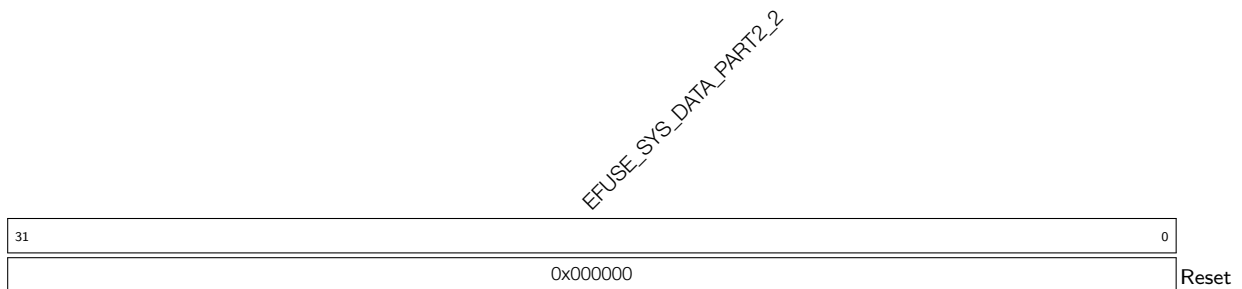
Register 6.90. EFUSE_RD_SYS_PART2_DATA2_REG (0x0164)

EFUSE_SYS_DATA_PART2_2 Represents the 2nd 32 bits of the 2nd part of system data. (RO)

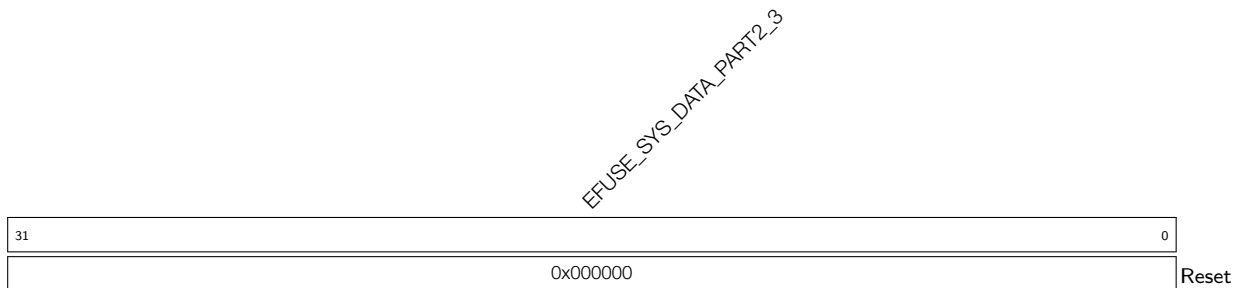
Register 6.91. EFUSE_RD_SYS_PART2_DATA3_REG (0x0168)

EFUSE_SYS_DATA_PART2_3 Represents the 3rd 32 bits of the 2nd part of system data. (RO)

Register 6.92. EFUSE_RD_SYS_PART2_DATA4_REG (0x016C)

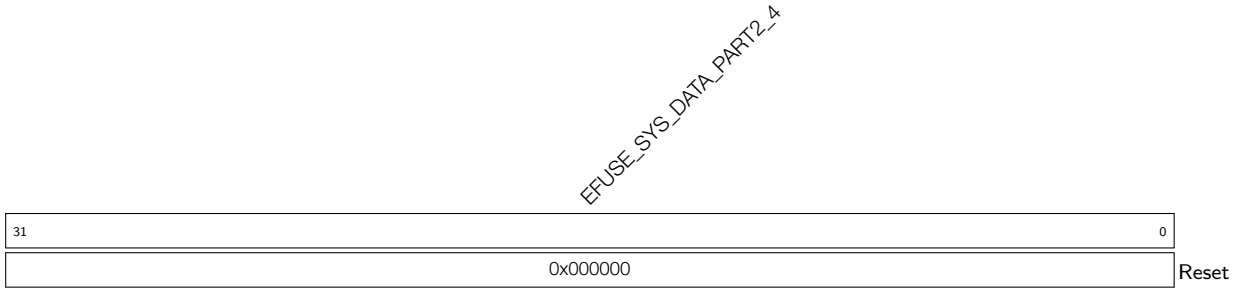

EFUSE_SYS_DATA_PART2_4 Represents the 4th 32 bits of the 2nd part of system data. (RO)

Register 6.93. EFUSE_RD_SYS_PART2_DATA5_REG (0x0170)

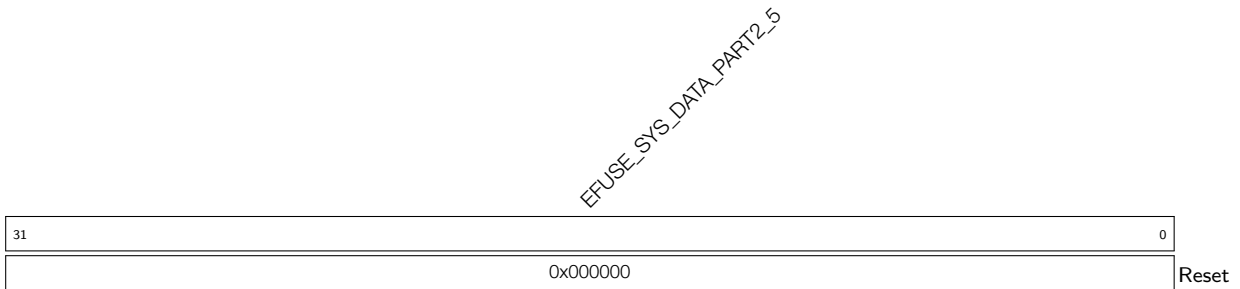

EFUSE_SYS_DATA_PART2_5 Represents the 5th 32 bits of the 2nd part of system data. (RO)

Register 6.94. EFUSE_RD_SYS_PART2_DATA6_REG (0x0174)

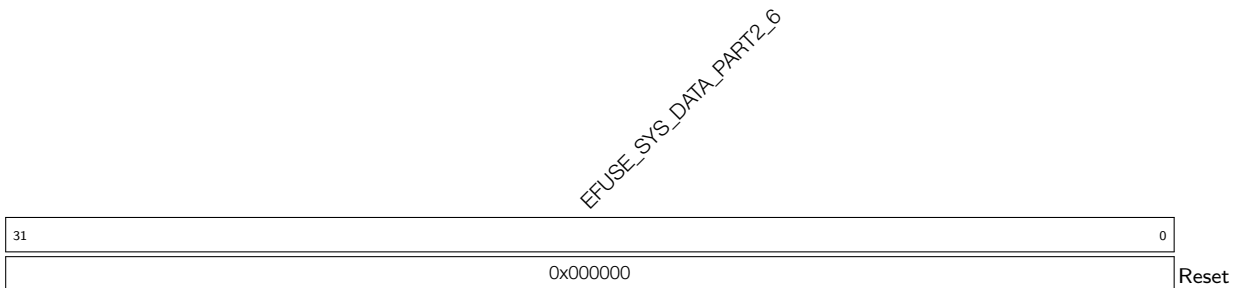

EFUSE_SYS_DATA_PART2_6 Represents the 6th 32 bits of the 2nd part of system data. (RO)

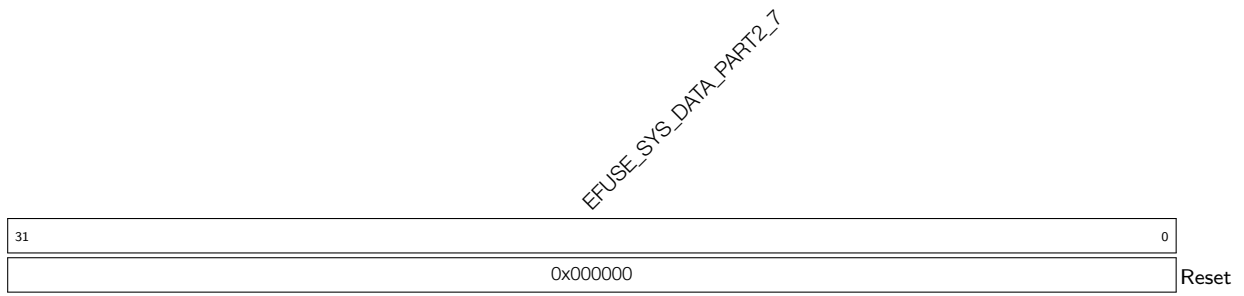
Register 6.95. EFUSE_RD_SYS_PART2_DATA7_REG (0x0178)

EFUSE_SYS_DATA_PART2_7 Represents the 7th 32 bits of the 2nd part of system data. (RO)

Register 6.96. EFUSE_RD_REPEAT_ERR0_REG (0x017C)

EFUSE_RPT4_RESERVED0_ERR_0 EFUSE_RPT4_RESERVED0_ERR_1 EFUSE_RPT4_RESERVED0_ERR_2 EFUSE_VDD_SPI_AS_GPIO_ERR EFUSE_USB_EXCHG_PINS_ERR (reserved) EFUSE_DIS_DOWNLOAD_MANUAL_ENCRYPT_ERR EFUSE_DIS_PAD_JTAG_ERR EFUSE_SOFT_DIS_JTAG_ERR EFUSE_JTAG_SEL_ENABLE_ERR EFUSE_DIS_TWAI_ERR EFUSE_SPI_DOWNLOAD_MSPI_DIS_ERR EFUSE_DIS_FORCE_DOWNLOAD_ERR EFUSE_DIS_USB_SERIAL_JTAG_ERR EFUSE_DIS_DOWNLOAD_ICACHE_ERR EFUSE_SWAP_UART_SDIO_EN_ERR EFUSE_RD_DIS_ERR																														
31	30	29	28	27	26	25	24		21	20	19	18		16	15	14	13	12	11	10	9	8	7	6		0				
0x0	0	0x0	0	0	0	0	0	0	0	0	0	0x0	0	0	0	0	0	0	0	0	0	0	0	0	0	0	0x0			

Reset

EFUSE_RD_DIS_ERR Any bit of this field being 1 represents a programming error of RD_DIS. (RO)

EFUSE_SWAP_UART_SDIO_EN_ERR This bit being 1 represents a programming error of SWAP_UART_SDIO_EN. (RO)

EFUSE_DIS_ICACHE_ERR This bit being 1 represents a programming error of DIS_ICACHE. (RO)

EFUSE_DIS_USB_JTAG_ERR This bit being 1 represents a programming error of DIS_USB_JTAG. (RO)

EFUSE_DIS_DOWNLOAD_ICACHE_ERR This bit being 1 represents a programming error of DIS_DOWNLOAD_ICACHE. (RO)

EFUSE_DIS_USB_SERIAL_JTAG_ERR This bit being 1 represents a programming error of DIS_USB_DEVICE. (RO)

EFUSE_DIS_FORCE_DOWNLOAD_ERR This bit being 1 represents a programming error of DIS_FORCE_DOWNLOAD. (RO)

EFUSE_SPI_DOWNLOAD_MSPI_DIS_ERR This bit being 1 represents a programming error of SPI_DOWNLOAD_MSPI_DIS. (RO)

EFUSE_DIS_TWAI_ERR This bit being 1 represents a programming error of DIS_TWAI. (RO)

EFUSE_JTAG_SEL_ENABLE_ERR This bit being 1 represents a programming error of JTAG_SEL_ENABLE. (RO)

EFUSE_SOFT_DIS_JTAG_ERR Any bit of this field being 1 represents a programming error of SOFT_DIS_JTAG. (RO)

EFUSE_DIS_PAD_JTAG_ERR This bit being 1 represents a programming error of DIS_PAD_JTAG. (RO)

EFUSE_DIS_DOWNLOAD_MANUAL_ENCRYPT_ERR This bit being 1 represents a programming error of DIS_DOWNLOAD_MANUAL_ENCRYPT. (RO)

Continued on the next page...

Register 6.96. EFUSE_RD_REPEAT_ERR0_REG (0x0080)

Continued from the previous page...

EFUSE_USB_EXCHG_PINS_ERR This bit being 1 represents a programming error of USB_EXCHG_PINS. (RO)

EFUSE_VDD_SPI_AS_GPIO_ERR This bit being 1 represents a programming error of VDD_SPI_AS_GPIO. (RO)

EFUSE_RPT4_RESERVED0_ERR_2 Reserved. (RO)

EFUSE_RPT4_RESERVED0_ERR_1 Reserved. (RO)

EFUSE_RPT4_RESERVED0_ERR_0 Reserved. (RO)

Register 6.97. EFUSE_RD_REPEAT_ERR1_REG (0x0180)

EFUSE_KEY_PURPOSE_1_ERR		EFUSE_KEY_PURPOSE_0_ERR		EFUSE_SECURE_BOOT_KEY_REVOKE2_ERR		EFUSE_SECURE_BOOT_KEY_REVOKE1_ERR		EFUSE_SECURE_BOOT_KEY_REVOKE0_ERR		EFUSE_SPI_BOOT_CRYPT_CNT_ERR		EFUSE_WDT_DELAY_SEL_ERR		EFUSE_RPT4_RESERVED1_ERR_0	
31	28	27	24	23	22	21	20	18	17	16	15				0
0x0		0x0		0	0	0	0x0		0x0		0x00			Reset	

EFUSE_RPT4_RESERVED1_ERR_0 Reserved. (RO)

EFUSE_WDT_DELAY_SEL_ERR Any bit of this field being 1 represents a programming error of WDT_DELAY_SEL. (RO)

EFUSE_SPI_BOOT_CRYPT_CNT_ERR Any bit of this field being 1 represents a programming error of SPI_BOOT_CRYPT_CNT. (RO)

EFUSE_SECURE_BOOT_KEY_REVOKE0_ERR This bit being 1 represents a programming error of SECURE_BOOT_KEY_REVOKE0. (RO)

EFUSE_SECURE_BOOT_KEY_REVOKE1_ERR This bit being 1 represents a programming error of SECURE_BOOT_KEY_REVOKE1. (RO)

EFUSE_SECURE_BOOT_KEY_REVOKE2_ERR This bit being 1 represents a programming error of SECURE_BOOT_KEY_REVOKE2. (RO)

EFUSE_KEY_PURPOSE_0_ERR Any bit of this field being 1 represents a programming error of KEY_PURPOSE_0. (RO)

EFUSE_KEY_PURPOSE_1_ERR Any bit of this field being 1 represents a programming error of KEY_PURPOSE_1. (RO)

Register 6.98. EFUSE_RD_REPEAT_ERR2_REG (0x0184)

EFUSE_FLASH_TPUW_ERR		EFUSE_RPT4_RESERVED2_ERR_0		EFUSE_SECURE_BOOT_AGGRESSIVE_REVOKE_ERR		EFUSE_SECURE_BOOT_EN_ERR		EFUSE_CRYPT_DPA_ENABLE_ERR		EFUSE_RPT4_RESERVED2_ERR_1		EFUSE_SEC_DPA_LEVEL_ERR		EFUSE_KEY_PURPOSE_5_ERR		EFUSE_KEY_PURPOSE_4_ERR		EFUSE_KEY_PURPOSE_3_ERR		EFUSE_KEY_PURPOSE_2_ERR	
31	28	27	22	21	20	19	18	17	16	15	12	11	8	7	4	3	0				
0x0		0x0		0	0	0	0	0x0		0x0		0x0		0x0		0x0		Reset			

EFUSE_KEY_PURPOSE_2_ERR Any bit of this field being 1 represents a programming error of KEY_PURPOSE_2. (RO)

EFUSE_KEY_PURPOSE_3_ERR Any bit of this field being 1 represents a programming error of KEY_PURPOSE_3. (RO)

EFUSE_KEY_PURPOSE_4_ERR Any bit of this field being 1 represents a programming error of KEY_PURPOSE_4. (RO)

EFUSE_KEY_PURPOSE_5_ERR Any bit of this field being 1 represents a programming error of KEY_PURPOSE_5. (RO)

EFUSE_SEC_DPA_LEVEL_ERR This bit being 1 represents a programming error of SEC_DPA_LEVEL. (RO)

EFUSE_RPT4_RESERVED2_ERR_1 Reserved. (RO)

EFUSE_CRYPT_DPA_ENABLE_ERR This bit being 1 represents a programming error of CRYPT_DPA_ENABLE. (RO)

EFUSE_SECURE_BOOT_EN_ERR This bit being 1 represents a programming error of SECURE_BOOT_EN. (RO)

EFUSE_SECURE_BOOT_AGGRESSIVE_REVOKE_ERR This bit being 1 represents a programming error of SECURE_BOOT_AGGRESSIVE_REVOKE. (RO)

EFUSE_RPT4_RESERVED2_ERR_0 Reserved. (RO)

EFUSE_FLASH_TPUW_ERR Any bit of this field being 1 represents a programming error of FLASH_TPUW. (RO)

Register 6.99. EFUSE_RD_REPEAT_ERR3_REG (0x0188)

EFUSE_RPT4_RESERVED3_ERR_0									EFUSE_SECURE_VERSION_ERR						EFUSE_FORCE_SEND_RESUME_ERR						EFUSE_RPT4_RESERVED3_ERR_1						EFUSE_RPT4_RESERVED3_ERR_2						EFUSE_UART_PRINT_CONTROL_ERR						EFUSE_ENABLE_SECURITY_DOWNLOAD_ERR						EFUSE_DIS_DOWNLOAD_MODE_ERR						EFUSE_RPT4_RESERVED3_ERR_3						EFUSE_RPT4_RESERVED3_ERR_4						EFUSE_DIS_DIRECT_BOOT_ERR						EFUSE_USB_PRINT_ERR						EFUSE_RPT4_RESERVED3_ERR_5						EFUSE_DIS_DOWNLOAD_MODE_ERR					
31	30	29												14	13	12	11	10	9	8	7	6	5	4	3	2	1	0												Reset																																														
0x0		0x00											0	0	0x0	0	0	0x0	0	0	0	0	0	0	0	0	0	0	0	0												0																																												

EFUSE_DIS_DOWNLOAD_MODE_ERR This bit being 1 represents a programming error of DIS_DOWNLOAD_MODE. (RO)

EFUSE_DIS_DIRECT_BOOT_ERR This bit being 1 represents a programming error of DIS_DIRECT_BOOT. (RO)

EFUSE_USB_PRINT_ERR This bit being 1 represents a programming error of UART_PRINT_CHANNEL. (RO)

EFUSE_RPT4_RESERVED3_ERR_5 Reserved. (RO)

EFUSE_DIS_USB_SERIAL_JTAG_DOWNLOAD_MODE_ERR This bit being 1 represents a programming error of DIS_USB_SERIAL_JTAG_DOWNLOAD_MODE. (RO)

EFUSE_ENABLE_SECURITY_DOWNLOAD_ERR This bit being 1 represents a programming error of ENABLE_SECURITY_DOWNLOAD. (RO)

EFUSE_UART_PRINT_CONTROL_ERR Any bit of this field being 1 represents a programming error of UART_PRINT_CONTROL. (RO)

EFUSE_RPT4_RESERVED3_ERR_4 Reserved. (RO)

EFUSE_RPT4_RESERVED3_ERR_3 Reserved. (RO)

EFUSE_RPT4_RESERVED3_ERR_2 Reserved. (RO)

EFUSE_RPT4_RESERVED3_ERR_1 Reserved. (RO)

EFUSE_FORCE_SEND_RESUME_ERR This bit being 1 represents a programming error of FORCE_SEND_RESUME. (RO)

EFUSE_SECURE_VERSION_ERR Any bit of this field being 1 represents a programming error of SECURE_VERSION. (RO)

EFUSE_RPT4_RESERVED3_ERR_0 Reserved. (RO)

Register 6.100. EFUSE_RD_REPEAT_ERR4_REG (0x0190)

<i>EFUSE_RPT4_RESERVED4_ERR_0</i>		<i>EFUSE_RPT4_RESERVED4_ERR_1</i>	
31	24	23	0
0x0		0x0000	
			Reset

EFUSE_RPT4_RESERVED4_ERR_1 Reserved. (RO)

EFUSE_RPT4_RESERVED4_ERR_0 Reserved. (RO)

Register 6.101. EFUSE_RD_RS_ERR0_REG (0x01C0)

31	30	28	27	26	24	23	22	20	19	18	16	15	14	12	11	10	8	7	6	4	3	2	0
0	0x0	0	0x0	0	0x0	0	0x0	0	0x0	0	0x0	0	0x0	0	0x0	0	0x0	0	0x0	0	0x0	0	0x0

Reset

EFUSE_MAC_SPI_8M_ERR_NUM Represents the number of error bytes. (RO)

EFUSE_MAC_SPI_8M_FAIL Represents whether programming MAC_SPI_8M failed.

0: No failure and the data of MAC_SPI_8M is reliable.

1: Programming user data failed and the number of error bytes is over 6.

(RO)

EFUSE_SYS_PART1_ERR_NUM Represents the number of error bytes. (RO)

EFUSE_SYS_PART1_FAIL Represents whether programming system part1 data failed.

0: No failure and the data of system part1 is reliable.

1: Programming user data failed and the number of error bytes is over 6.

(RO)

EFUSE_USR_DATA_ERR_NUM Represents the number of error bytes. (RO)

EFUSE_USR_DATA_FAIL Represents whether programming user data failed.

0: No failure and the user data is reliable.

1: Programming user data failed and the number of error bytes is over 6.

(RO)

EFUSE_KEY0_ERR_NUM Represents the number of error bytes. (RO)

EFUSE_KEY0_FAIL Represents whether programming key0 data failed.

0: No failure and the data of key0 is reliable.

1: Programming key0 failed and the number of error bytes is over 6.

(RO)

EFUSE_KEY1_ERR_NUM Represents the number of error bytes. (RO)

EFUSE_KEY1_FAIL Represents whether programming key1 data failed.

0: No failure and the data of key1 is reliable.

1: Programming key1 failed and the number of error bytes is over 6.

(RO)

EFUSE_KEY2_ERR_NUM Represents the number of error bytes. (RO)

EFUSE_KEY2_FAIL Represents whether programming key2 data failed.

0: No failure and the data of key2 is reliable.

1: Programming key2 failed and the number of error bytes is over 6.

(RO)

Continued on the next page...

Register 6.101. EFUSE_RD_RS_ERR0_REG (0x01C0)

Continued from the previous page...

EFUSE_KEY3_ERR_NUM Represents the number of error bytes. (RO)

EFUSE_KEY3_FAIL Represents whether programming key3 data failed.

0: No failure and the data of key3 is reliable.

1: Programming key3 failed and the number of error bytes is over 6.

(RO)

EFUSE_KEY4_ERR_NUM Represents the number of error bytes. (RO)

EFUSE_KEY4_FAIL Represents whether programming key4 data failed.

0: No failure and the data of key4 is reliable.

1: Programming key4 failed and the number of error bytes is over 6.

(RO)

Register 6.102. EFUSE_RD_RS_ERR1_REG (0x01C4)

(reserved)								EFUSE_SYS_PART2_FAIL				EFUSE_SYS_PART2_ERR_NUM				EFUSE_KEY5_FAIL				EFUSE_KEY5_ERR_NUM			
31									8	7	6			4	3	2			0				
0 0 0 0 0 0 0 0								0 0		0x0		0		0x0		Reset							

EFUSE_KEY5_ERR_NUM Represents the number of error bytes. (RO)

EFUSE_KEY5_FAIL Represents whether programming key5 data failed.

0: No failure and the data of key5 is reliable.

1: Programming key5 failed and the number of error bytes is over 6.

(RO)

EFUSE_SYS_PART2_ERR_NUM Represents the number of error bytes. (RO)

EFUSE_SYS_PART2_FAIL Represents whether programming system part2 data failed.

0: No failure and the data of system part2 is reliable.

1: Programming user data failed and the number of error bytes is over 6.

(RO)

Register 6.103. EFUSE_CLK_REG (0x01C8)

(reserved)																EFUSE_CLK_EN				(reserved)																EFUSE_MEM_FORCE_PU			EFUSE_MEM_CLK_FORCE_ON			EFUSE_MEM_FORCE_PD				
31																17	16	15												3	2	1	0													
0																	0				0																0			1			0			Reset

EFUSE_MEM_FORCE_PD Configures whether or not to force eFuse SRAM into power-saving mode.

- 1: Force
 - 0: No effect
- (R/W)

EFUSE_MEM_CLK_FORCE_ON Configures whether or not to force activate clock signal of eFuse SRAM.

- 1: Force activate
 - 0: No effect
- (R/W)

EFUSE_MEM_FORCE_PU Configures whether or not to force eFuse SRAM into working mode.

- 1: Force
 - 0: No effect
- (R/W)

EFUSE_CLK_EN Configures whether or not to force enable eFuse register configuration clock signal.

- 1: Force
 - 0: The clock is enabled only during the reading and writing of registers
- (R/W)

Register 6.104. EFUSE_CONF_REG (0x01CC)

(reserved)																EFUSE_OP_CODE																			
31																16	15												0						
0																	0x00																		Reset

EFUSE_OP_CODE Configures operation command type.

- 0x5A5A: Pprogramming operation command
 - 0x5AA5: Read operation command
 - Other values: No effect
- (R/W)

Register 6.105. EFUSE_STATUS_REG (0x01D0)

(reserved)										EFUSE_BLK0_VALID_BIT_CNT										(reserved)				EFUSE_STATE									
31											20	19											10	9					4	3			0
0 0 0 0 0 0 0 0 0 0										0 0 0 0 0 0 0 0 0 0										0x0				0 0 0 0 0 0 0				0x0		Reset			

EFUSE_STATE Represents the state of the eFuse state machine. (RO)

EFUSE_BLK0_VALID_BIT_CNT Represents the number of block valid bit. (RO)

Register 6.106. EFUSE_CMD_REG (0x01D4)

(reserved)																				EFUSE_BLK_NUM				EFUSE_PGM_CMD		EFUSE_READ_CMD	
31																	6	5			2	1			0		
0 0 0 0 0 0 0 0 0 0 0 0 0 0 0 0																0x0				0		0		Reset			

EFUSE_READ_CMD Configures whether or not to send read command.
 1: Send
 0: No effect
 (R/W/SC)

EFUSE_PGM_CMD Configures whether or not to send programming command.
 1: Send
 0: No effect
 (R/W/SC)

EFUSE_BLK_NUM Represents the serial number of the block to be programmed. Value 0-10 corresponds to block number 0-10, respectively. (R/W)

Register 6.107. EFUSE_INT_RAW_REG (0x01D8)

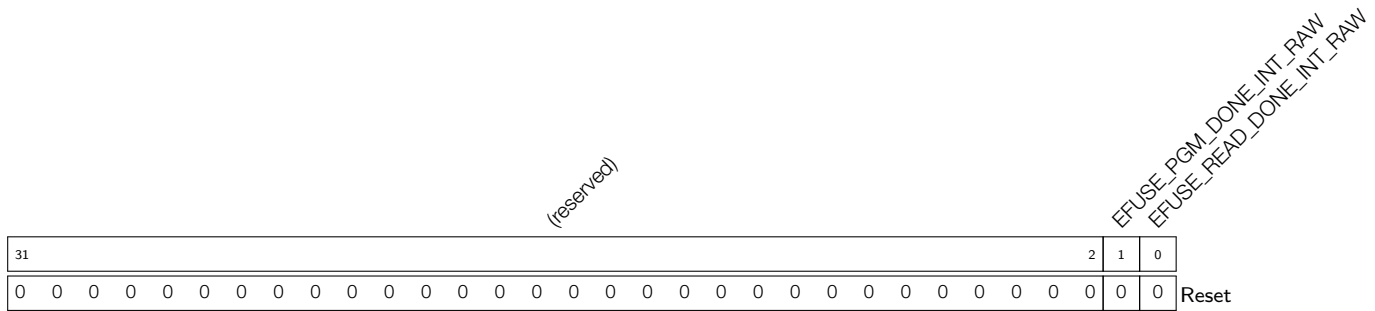

EFUSE_READ_DONE_INT_RAW The raw interrupt status of read_done. (R/SS/WTC)

EFUSE_PGM_DONE_INT_RAW The raw interrupt status of pgm_done. (R/SS/WTC)

Register 6.108. EFUSE_INT_ST_REG (0x01DC)

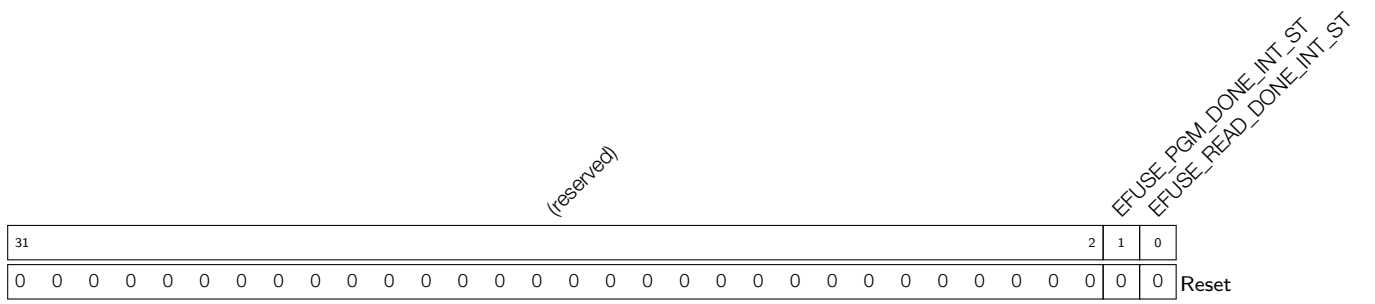

EFUSE_READ_DONE_INT_ST The masked interrupt status of read_done. (RO)

EFUSE_PGM_DONE_INT_ST The masked interrupt status of pgm_done. (RO)

Register 6.109. EFUSE_INT_ENA_REG (0x01E0)

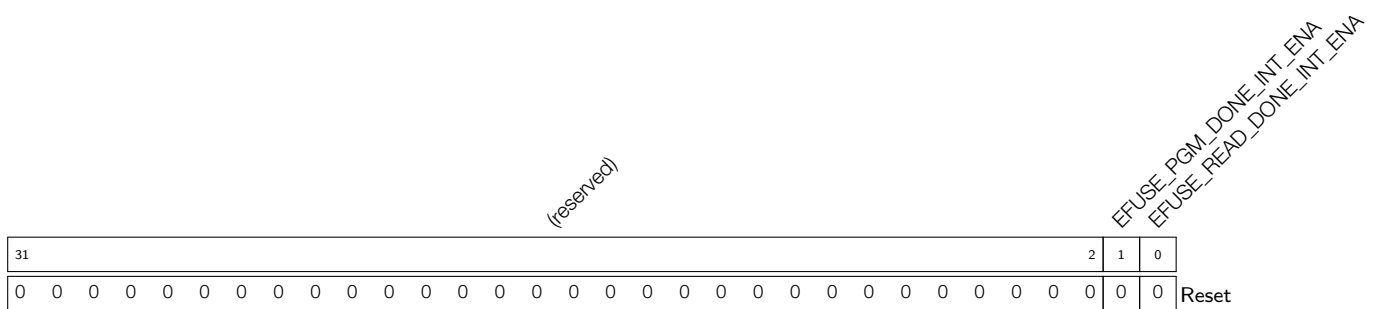

EFUSE_READ_DONE_INT_ENA Write 1 to enable read_done interrupt. (R/W)

EFUSE_PGM_DONE_INT_ENA Write 1 to enable pgm_done interrupt. (R/W)

Register 6.110. EFUSE_INT_CLR_REG (0x01E4)

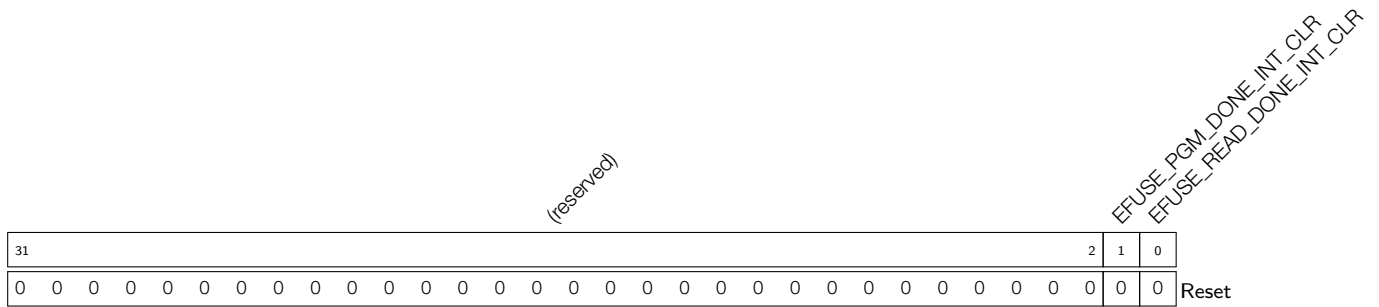

EFUSE_READ_DONE_INT_CLR Write 1 to clear read_done interrupt. (WO)

EFUSE_PGM_DONE_INT_CLR Write 1 to clear pgm_done interrupt. (WO)

Register 6.111. EFUSE_DAC_CONF_REG (0x01E8)

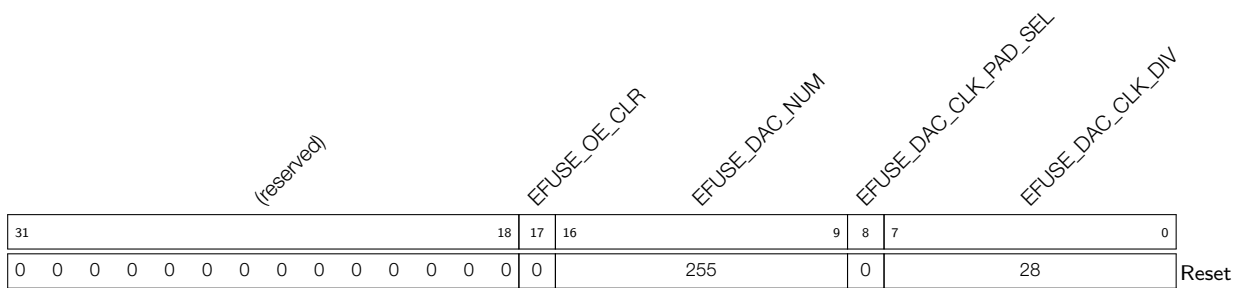

EFUSE_DAC_CLK_DIV Configures the division factor of the rising clock of the programming voltage. (R/W)

EFUSE_DAC_CLK_PAD_SEL Don't care. (R/W)

EFUSE_DAC_NUM Configures the rising period of the programming voltage. Measurement unit: Divided clock frequency by EFUSE_DAC_CLK_DIV. (R/W)

EFUSE_OE_CLR Reduces the power supply of the programming voltage. (R/W)

Register 6.112. EFUSE_RD_TIM_CONF_REG (0x01EC)

<i>EFUSE_READ_INIT_NUM</i>				<i>EFUSE_TSR_A</i>				<i>EFUSE_TRD</i>				<i>EFUSE_THR_A</i>				
31	24	23	16	15	8	7	0									
0x12				0x1				0x2				0x1				Reset

EFUSE_THR_A Configures the read hold time. Measurement unit: One cycle of the eFuse core clock. (R/W)

EFUSE_TRD Configures the read time. Measurement unit: One cycle of the eFuse core clock. (R/W)

EFUSE_TSR_A Configures the read setup time. Measurement unit: One cycle of the eFuse core clock. (R/W)

EFUSE_READ_INIT_NUM Configures the waiting time of reading eFuse memory. Measurement unit: One cycle of the eFuse core clock. (R/W)

Register 6.113. EFUSE_WR_TIM_CONF1_REG (0x01F0)

<i>EFUSE_THP_A</i>				<i>EFUSE_PWR_ON_NUM</i>				<i>EFUSE_TSUP_A</i>				
31	24	23	8	7	0							
0x1				0x3000				0x1				Reset

EFUSE_TSUP_A Configures the programming setup time. Measurement unit: One cycle of the eFuse core clock. (R/W)

EFUSE_PWR_ON_NUM Configures the power up time for VDDQ. Measurement unit: One cycle of the eFuse core clock. (R/W)

EFUSE_THP_A Configures the programming hold time. Measurement unit: One cycle of the eFuse core clock. (R/W)

Register 6.114. EFUSE_WR_TIM_CONF2_REG (0x01F4)

31	EFUSE_TPGM	16	15	0	EFUSE_PWR_OFF_NUM
0xc8			0x190		
Reset					

EFUSE_PWR_OFF_NUM Configures the power outage time for VDDQ. Measurement unit: One cycle of the eFuse core clock. (R/W)

EFUSE_TPGM Configures the active programming time. Measurement unit: One cycle of the eFuse core clock. (R/W)

Register 6.115. EFUSE_WR_TIM_CONF0_REG (0x01F8)

31	(reserved)	21	20	13	12	11	1	0	(reserved)		
0 0 0 0 0 0 0 0 0 0 0 0			0x1			0			0x0		0
Reset											

EFUSE_UPDATE Configures whether to update multi-bit register signals.

- 1: Update
 - 0: No effect
- (WT)

EFUSE_TPGM_INACTIVE Configures the inactive programming time. Measurement unit: One cycle of the eFuse core clock. (R/W)

Register 6.116. EFUSE_DATE_REG (0x01FC)

31	(reserved)	28	27	0	EFUSE_DATE
0 0 0 0			0x2206300		
Reset					

EFUSE_DATE Version control register. (R/W)

7 IO MUX and GPIO Matrix (GPIO, IO MUX)

7.1 Overview

The ESP32-C6 chip features 31 GPIO pins. Each pin can be used as a general-purpose I/O, or be connected to an internal peripheral signal. Through GPIO matrix, IO MUX, and low-power (LP) IO MUX, peripheral input signals can be from any IO pins, and peripheral output signals can be routed to any IO pins. Together these modules provide highly configurable I/O.

Note:

- The 31 GPIO pins are numbered from GPIO0 ~ GPIO30.
- For chip variants without an in-package flash, GPIO14 is not led out to any chip pins, so GPIO14 is not available to users.
- For chip variants with an in-package flash, GPIO24 ~ GPIO30 are dedicated to connecting the in-package flash, not for other uses. GPIO10 ~ GPIO11 are not led out to any chip pins, thus not available to users. The remaining 22 GPIO pins (numbered GPIO0 ~ GPIO9, GPIO12 ~ GPIO23) are configurable by users.

7.2 Features

GPIO matrix has the following features:

- A full-switching matrix between the peripheral input/output signals and the GPIO pins.
- 85 peripheral input signals sourced from the input of any GPIO pins.
- 93 peripheral output signals routed to the output of any GPIO pins.
- Signal synchronization for peripheral inputs based on **IO MUX operating clock**. For more information about the operating clock of IO MUX, please refer to Section 8 *Reset and Clock*.
- GPIO Filter hardware for input signal filtering.
- Glitch Filter hardware for second time filtering on input signal.
- Sigma delta modulated (SDM) output.
- GPIO simple input and output.

IO MUX has the following features:

- Better high-frequency digital performance achieved by some digital signals (SPI, JTAG, UART) bypassing GPIO matrix. In this case, IO MUX is used to connect these pins directly to peripherals.
- A configuration register `IO_MUX_GPIOn_REG` provided for each GPIO pin. The pin can be configured to
 - perform GPIO function routed by GPIO matrix;
 - or perform direct connection bypassing GPIO matrix.

LP IO MUX has the following feature:

- Control of eight LP GPIO pins (GPIO0 ~ GPIO7) that can be used by the peripherals in ULP and LP system.

7.3 Architectural Overview

Figure 7-1 shows in details how GPIO matrix, IO MUX, and LP IO MUX route signals from pins to peripherals, and from peripherals to pins.

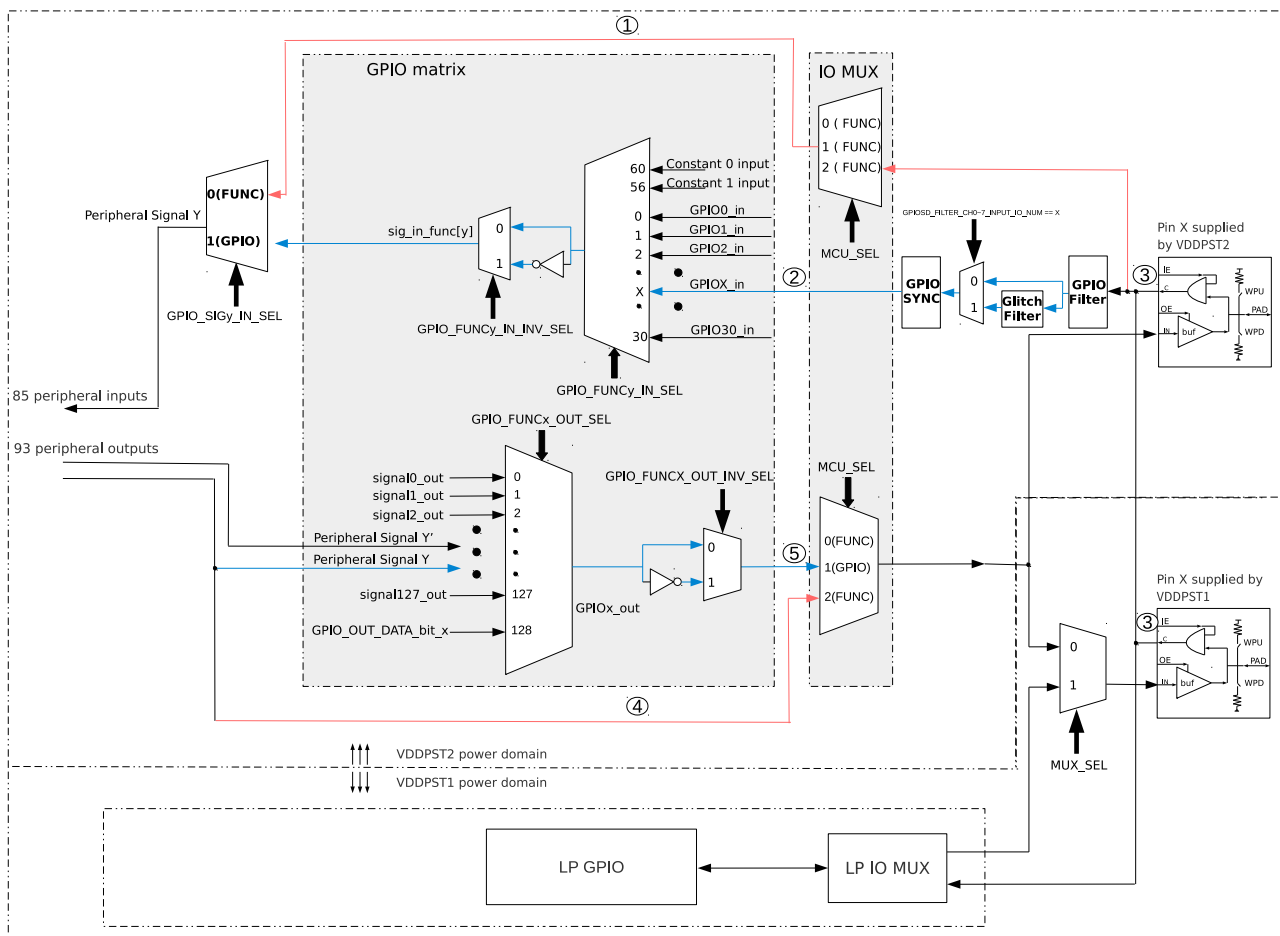

Figure 7-1. Architecture of IO MUX, LP IO MUX, and GPIO Matrix

1. Only part of peripheral input signals (marked “yes” in column “Direct input through IO MUX” in Table 7-2) can bypass GPIO matrix. The other input signals can only be routed to peripherals via GPIO matrix.
2. There are only 31 inputs from GPIO SYNC to GPIO matrix, since ESP32-C6 provides 31 GPIO pins in total.
Note:
 - For chip variants without an in-package flash, there are 30 inputs from GPIO SYNC to GPIO matrix in total. GPIO14 is not led out to any chip pins.
 - For chip variants with an in-package flash, there are only 22 inputs from GPIO SYNC to GPIO matrix in total. GPIO10 ~ GPIO11 are not let out to chip pins, and GPIO24 ~ GPIO30 are used to connect the in-package flash.
3. The pins supplied by VDDPST1 or by VDDPST2 are controlled by the signals: IE, OE, WPU, and WPD.
4. Only part of peripheral outputs (marked “yes” in column “Direct output through IO MUX” in Table 7-2) can be routed to pins bypassing GPIO matrix. The other output signals can only be routed to pins via GPIO matrix.
5. There are 31 outputs (corresponding to GPIO pin X: 0 ~ 30) from GPIO matrix to IO MUX. Note:

- For chip variants without an in-package flash, there are 30 outputs (corresponding to GPIO X: 0 ~ 13, 15 ~ 30) from GPIO matrix to IO MUX in total.
- For chip variants with an in-package flash, there are only 22 outputs (corresponding to GPIO X: 0 ~ 9, 12 ~ 23) from GPIO matrix to IO MUX in total.

Figure 7-2 shows the internal structure of a pad, which is an electrical interface between the chip logic and the GPIO pin. The structure is applicable to all 31 GPIO pins and can be controlled using IE, OE, WPU, and WPD signals.

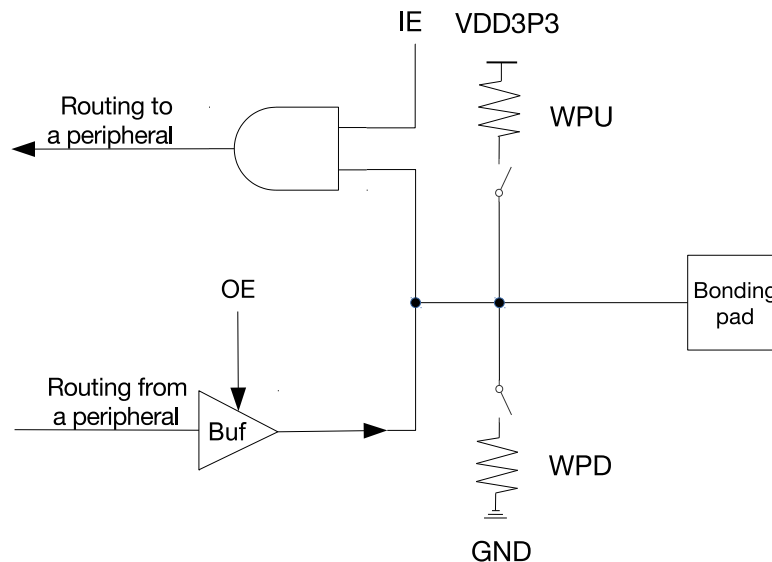

Figure 7-2. Internal Structure of a Pad

- IE: input enable
- OE: output enable
- WPU: internal weak pull-up resistor
- WPD: internal weak pull-down resistor
- Bonding pad: a terminal point of the chip logic used to make a physical connection from the chip die to GPIO pin in the chip package

7.4 Peripheral Input via GPIO Matrix

7.4.1 Overview

To receive a peripheral input signal via GPIO matrix, the matrix is configured to source the peripheral input signal from one of the 31 GPIOs (0 ~ 30), see Table 7-2. Meanwhile, the register corresponding to the peripheral signal should be set to receive input signal via GPIO matrix.

As shown in Figure 7-1, when GPIO matrix is used to input a signal from the pin, all external input signals are sourced from the GPIO pins and then filtered by the GPIO Filter, as shown in Step 2 in Section 7.4.3.

The Glitch Filter hardware can filter eight of the output signals from the GPIO Filter, and the other unselected signals go directly to the GPIO SYNC hardware, as shown in Step 3 in Section 7.4.3.

All signals filtered by the GPIO Filter hardware or the Glitch Filter hardware are synchronized by the GPIO SYNC hardware to IO MUX operating clock and then enter the GPIO matrix, see Section 7.4.2. Such signal filtering and synchronization features apply to all GPIO matrix signals but do not apply when using the IO MUX.

7.4.2 Signal Synchronization

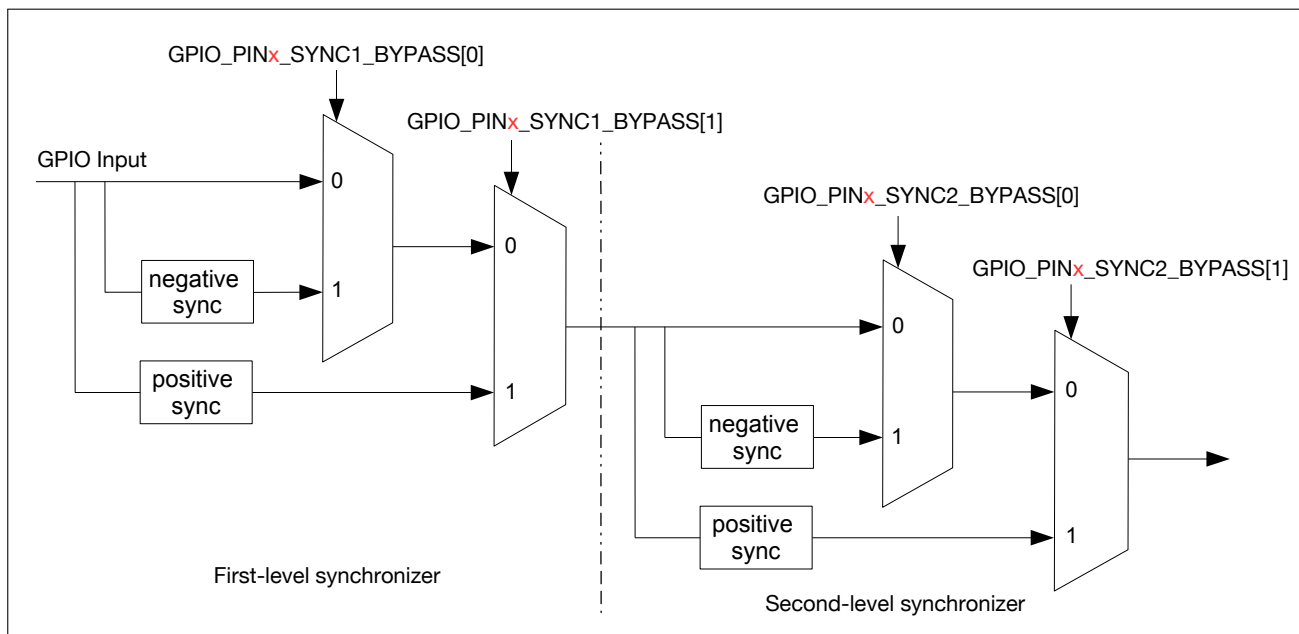

Figure 7-3. GPIO Input Synchronized on Rising Edge or on Falling Edge of IO MUX Operating Clock

Figure 7-3 shows the functionality of GPIO SYNC. In the figure, negative sync and positive sync mean GPIO input is synchronized on falling edge and on rising edge of IO MUX operating clock respectively.

The synchronization function is disabled by default by the synchronizer, i.e., `GPIO_PINx_SYNC1/2_BYPASS [1:0] = 0`. But when an asynchronous peripheral signal is connected to the pin, the signal should be synchronized by the two-level synchronizer (i.e., the first-level synchronizer and the second-level synchronizer as shown in Figure 7-3) to lower the probability of causing metastability. For more information, see Step 4 in the following section.

7.4.3 Functional Description

To read GPIO pin X^1 into peripheral signal Y , follow the steps below:

1. Configure register `GPIO_FUNCy_IN_SEL_CFG_REG` corresponding to peripheral signal Y in GPIO matrix:
 - Set `GPIO_SIGy_IN_SEL` to enable peripheral signal input via GPIO matrix.
 - Set `GPIO_FUNCy_IN_SEL` to the desired GPIO pin, i.e., X here.

Note that some peripheral signals have no valid `GPIO_SIGy_IN_SEL` bit, namely, these peripherals can only receive input signals via GPIO matrix.

2. Optionally enable the GPIO Filter for pin input signals by setting `IO_MUX_GPIOx_FILTER_EN`. Only the signals with a valid width of more than two clock cycles can be sampled, see Figure 7-4.

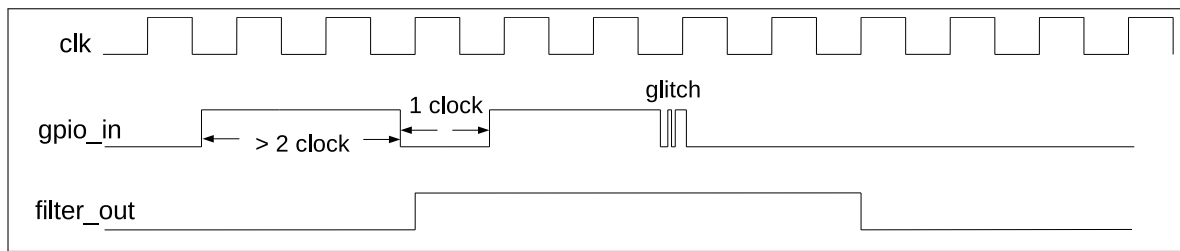

Figure 7-4. GPIO Filter Timing of GPIO Input Signals

3. Glitch filter hardware supports eight channels, each of which selects one signal from the 31 (0~30) output signals from the GPIO Filter hardware and conducts the second-time filtering on the selected signal. This Glitch Filter hardware can be used to filter slow-speed signals. To enable this feature, follow the steps below:

- Configure `GPIOSD_FILTER_CH n _INPUT_IO_NUM` to m . n (0 ~ 7) represents the channel number. m (0 ~ 30) represents the GPIO pin number.
- Configure `GPIOSD_FILTER_CH n _WINDOW_WIDTH` to **VALUE1** and `GPIOSD_FILTER_CH n _WINDOW_THRES` to **VALUE2**. During **VALUE1** + 1 cycles, if there are **VALUE2** + 1 input signals that do not match the current output signal value, the Glitch Filter hardware inverts the output signal. `GPIOSD_FILTER_CH n _WINDOW_WIDTH` and `GPIOSD_FILTER_CH n _WINDOW_THRES` can be configured to the same value **VALUE3**, then only signals with a width greater than **VALUE3** + 1 clock cycles will be sampled.
- Set `GPIOSD_FILTER_CH n _EN` to enable channel n .

An example is shown in Figure 7-5, where `GPIOSD_FILTER_CH x _WINDOW_WIDTH` is configured to 3 and `GPIOSD_FILTER_CH x _WINDOW_THRES` to 2. The output signal value (signal_out) keeps as “0” in the four clock cycles before T1. The input signal value (signal_in) has been “1” for three clock cycles in the same period, then the output signal is inverted to “1” after T1.

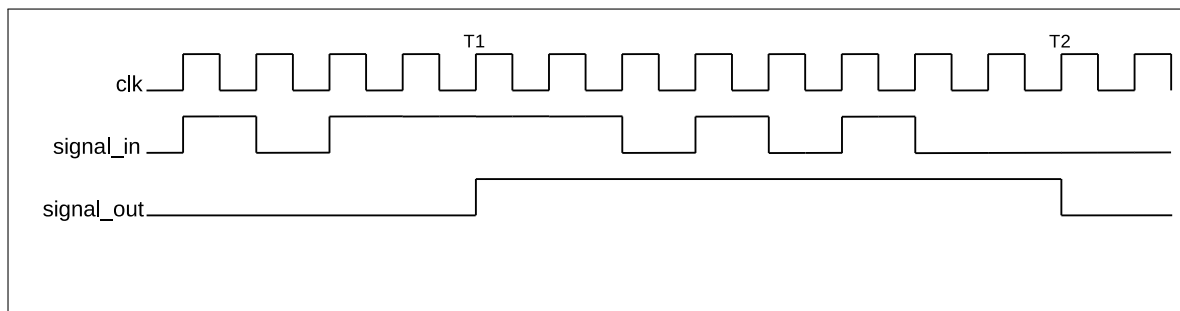

Figure 7-5. Glitch Filter Timing Example

4. Synchronize GPIO input signals. To do so, please set `GPIO_PIN x _REG` corresponding to GPIO pin X as follows:

- Set `GPIO_PIN x _SYNC1_BYPASS` to enable input signal synchronized on rising edge or on falling edge in the first-level synchronization, see Figure 7-3.
- Set `GPIO_PIN x _SYNC2_BYPASS` to enable input signal synchronized on rising edge or on falling edge in the second-level synchronization, see Figure 7-3.

5. Configure IO MUX register to enable pin input. For this end, please set `IO_MUX_GPIOx_REG` corresponding to GPIO pin `X` as follows:

- Set `IO_MUX_GPIOx_FUN_IE` to enable input².
- Set or clear `IO_MUX_GPIOx_FUN_WPU` and `IO_MUX_GPIOx_FUN_WPD` as desired to enable or disable pull-up and pull-down resistors.

For example, to connect I2S MSCK input signal ³ (`I2S_MCLK_in`, signal index 12) to GPIO7, please follow the steps below. Note that GPIO7 is also named as MTDO pin.

1. Set `GPIO_SIG12_IN_SEL` in register `GPIO_FUNC12_IN_SEL_CFG_REG` to enable peripheral signal input via GPIO matrix.
2. Set `GPIO_FUNC12_IN_SEL` in register `GPIO_FUNC12_IN_SEL_CFG_REG` to 7, i.e., select GPIO7.
3. Set `IO_MUX_GPIO7_FUN_IE` in register `IO_MUX_GPIO7_REG` to enable pin input.

Note:

1. One input pin can be connected to multiple peripheral input signals.
2. The input signal can be inverted by configuring `GPIO_FUNCy_IN_INV_SEL`.
3. It is possible to have a peripheral read a constantly low or constantly high input value without connecting this input to a pin. This can be done by selecting a special `GPIO_FUNCy_IN_SEL` input, instead of a GPIO number:
 - When `GPIO_FUNCy_IN_SEL` is set to 0x3C, input signal is always 0.
 - When `GPIO_FUNCy_IN_SEL` is set to 0x38, input signal is always 1.

7.4.4 Simple GPIO Input

GPIO matrix can also be used for simple GPIO input. For this case, the input value of one GPIO pin can be read at any time without routing the GPIO input to any peripherals. `GPIO_IN_REG` holds the input values of each GPIO pin.

To implement simple GPIO input, follow the steps below:

- Set `IO_MUX_GPIOx_FUN_IE` in register `IO_MUX_GPIOx_REG`, to enable pin input.
- Read the GPIO input from `GPIO_IN_REG[x]`.

7.5 Peripheral Output via GPIO Matrix

7.5.1 Overview

To output a signal from a peripheral via GPIO matrix, the matrix is configured to route peripheral output signals (only signals with a name assigned in the column “Output signal” in Table 7-2) to one of the 31 GPIOs (0 ~ 30).

Note:

- For chip variants without an in-package flash, output signals can be mapped to 30 GPIO pins, i.e., GPIO0 ~ GPIO13, GPIO15 ~ GPIO30.
- For chip variants with an in-package flash, output signals can only be mapped to 22 GPIO pins, i.e., GPIO0 ~ GPIO9, GPIO12 ~ GPIO23.

The output signal is routed from the peripheral into GPIO matrix and then into IO MUX. IO MUX must be configured to set the chosen pin to GPIO function. This enables the GPIO output signal to be connected to the pin.

Note:

There is a range of peripheral output signals (97 ~ 100 in Table 7-2) which are not connected to any peripheral, but to the input signals (97 ~ 100) directly.

7.5.2 Functional Description

The 93 output signals (signals with a name assigned in the column “Output signal” in Table 7-2) can be set to go through GPIO matrix into IO MUX and then to a pin. Figure 7-1 illustrates the configuration.

To output peripheral signal Y to a particular GPIO pin X^1 , follow the steps below:

1. Configure registers `GPIO_FUNC x _OUT_SEL_CFG_REG` and `GPIO_ENABLE_REG $[x]$` corresponding to GPIO pin X in GPIO matrix. Recommended operation: use corresponding `W1TS` (write 1 to set) and `W1TC` (write 1 to clear) registers to set or clear `GPIO_ENABLE_REG`.
 - Set the `GPIO_FUNC x _OUT_SEL` field in register `GPIO_FUNC x _OUT_SEL_CFG_REG` to the index of the desired peripheral output signal Y .
 - If the signal should always be enabled as an output, set the `GPIO_FUNC x _OEN_SEL` bit in register `GPIO_FUNC x _OUT_SEL_CFG_REG` and the bit in register `GPIO_ENABLE_W1TS_REG`, corresponding to GPIO pin X . To have the output enable signal decided by internal logic (for example, the `SPIQ_oe` in column “Output enable signal when `GPIO_FUNC n _OEN_SEL = 0`” in Table 7-2), clear the `GPIO_FUNC x _OEN_SEL` bit instead.
 - Set the corresponding bit in register `GPIO_ENABLE_W1TC_REG` to disable the output from the GPIO pin.
2. For an open drain output, set the `GPIO_PIN x _PAD_DRIVER` bit in register `GPIO_PIN x _REG` corresponding to GPIO pin X .
3. Configure IO MUX register to enable output via GPIO matrix. Set `IO_MUX_GPIO x _REG` corresponding to GPIO pin X as follows:
 - Set the field `IO_MUX_GPIO x _MCU_SEL` to desired IO MUX function corresponding to GPIO pin X . This is Function 1 (GPIO function), numeric value 1, for all pins.
 - Set the `IO_MUX_GPIO x _FUN_DRV` field to the desired value for output strength (0 ~ 3). The higher the drive strength, the more current can be sourced/sunk from the pin.
 - 0: ~5 mA
 - 1: ~10 mA
 - 2: ~20 mA (default)
 - 3: ~40 mA
 - If using open drain mode, set/clear the `IO_MUX_GPIO x _FUN_WPU` and `IO_MUX_GPIO x _FUN_WPD` bits to enable/disable the internal pull-up/pull-down resistors.

Note:

1. The output signal from a single peripheral can be sent to multiple pins simultaneously.
2. The output signal can be inverted by setting `GPIO_FUNCx_OUT_INV_SEL`.

7.5.3 Simple GPIO Output

GPIO matrix can also be used for simple GPIO output. For this case, one GPIO pin can be configured to directly output the desired value, without routing any peripheral output to this pin. This can be done as below:

- Set GPIO matrix `GPIO_FUNCn_OUT_SEL` with a special peripheral index 128 (0x80);
- Set the corresponding bit in `GPIO_OUT_REG` register to the desired GPIO output value.

Note:

- `GPIO_OUT_REG[0] ~ GPIO_OUT_REG[30]` correspond to GPIO0 ~ GPIO30 respectively. `GPIO_OUT_REG[31]` is invalid.
- Recommended operation: use `GPIO_OUT_W1TS/GPIO_OUT_W1TC` to set or clear the register `GPIO_OUT_REG`.

7.5.4 Sigma Delta Modulated Output (SDM)

7.5.4.1 Functional Description

Four out of the 93 peripheral output signals (index: 83 ~ 86 in Table 7-2 support 1-bit second-order sigma delta modulation. By default the output is enabled for these four channels. This Sigma Delta modulator can also output PDM (pulse density modulation) signal with configurable duty cycle. The transfer function is:

$$H(z) = X(z)z^{-1} + E(z)(1-z^{-1})^2$$

$E(z)$ is quantization error and $X(z)$ is the input.

This modulator supports scaling down of IO MUX operating clock by divider 1 ~ 256:

- Set `GPIOSD_FUNCTION_CLK_EN` to enable the modulator clock.
- Configure `GPIOSD_SDn_PRESCALE` ($n = 0 \sim 3$ for the four channels).

After scaling, the clock cycle is equal to one pulse output cycle from the modulator.

`GPIOSD_SDn_IN` is a signed number with a range of [-128, 127] and is used to control the duty cycle¹ of PDM output signal.

- `GPIOSD_SDn_IN` = -128, the duty cycle of the output signal is 0%.
- `GPIOSD_SDn_IN` = 0, the duty cycle of the output signal is near 50%.
- `GPIOSD_SDn_IN` = 127, the duty cycle of the output signal is near 100%.

The formula for calculating PDM signal duty cycle is shown as below:

$$Duty_Cycle = \frac{GPIOSD_SDn_IN + 128}{256}$$

Note:

For PDM signals, duty cycle refers to the percentage of high level cycles to the whole statistical period (several pulse cycles, for example, 256 pulse cycles).

7.5.4.2 SDM Configuration

The configuration of SDM is shown below:

- Route one of SDM outputs to a pin via GPIO matrix, see Section 7.5.2.
- Enable the modulator clock by setting `GPIOSD_FUNCTION_CLK_EN`.
- Configure the divider value by setting `GPIOSD_SD n _PRESCALE`.
- Configure the duty cycle of SDM output signal by setting `GPIOSD_SD n _IN`.

7.6 Direct Input and Output via IO MUX

7.6.1 Overview

Some digital signals (SPI and JTAG) can bypass GPIO matrix for better high-frequency digital performance. In this case, IO MUX is used to connect these pins directly to peripherals.

This option is less flexible than routing signals via GPIO matrix, as the IO MUX register for each GPIO pin can only select from a limited number of functions, but high-frequency digital performance can be improved.

7.6.2 Functional Description

Two fields must be configured in order to bypass GPIO matrix for peripheral input signals:

1. `IO_MUX_GPIO n _MCU_SEL` for the GPIO pin must be set to the required pin function. For the list of pin functions, please refer to Section 7.12.
2. Clear `GPIO_SIG n _IN_SEL` to route the input directly to the peripheral.

To bypass GPIO matrix for peripheral output signals, `IO_MUX_GPIO n _MCU_SEL` for the GPIO pin must be set to the required pin function.

Note:

Not all signals can be directly connected to peripheral via IO MUX. Some input/output signals can only be connected to peripheral via GPIO matrix.

7.7 LP IO MUX for Low Power and Analog Input/Output

7.7.1 Overview

ESP32-C6 provides eight GPIO pins with low power (LP) capabilities and analog functions. These pins can be controlled by either IO MUX or LP IO MUX.

If controlled by LP IO MUX, these pins will bypass IO MUX and GPIO matrix for the use by ULP and peripherals in LP system.

When configured as LP GPIOs, the pins can still be controlled by ULP or the peripherals in LP system during chip Deep-sleep, and wake up the chip from Deep-sleep.

7.7.2 Low Power Capabilities

The pins with LP functions are controlled by `LP_AON_GPIO_MUX_SEL[n]` ($n = \text{GPIO0} \sim \text{GPIO7}$) bit in register `LP_AON_GPIO_MUX_REG`. By default, all bits in these registers are set to 0, routing all input/output signals via IO MUX.

If `LP_AON_GPIO_MUX_SEL[n]` is set to 1, then input/output signals are controlled by LP IO MUX. In this mode, `LP_IO_GPIO n _REG` is used to control the LP GPIO pins. See 7-4 for the LP functions of each LP GPIO pin. Note that `LP_IO_GPIO n _REG` applies the LP GPIO pin numbering, not the GPIO pin numbering.

7.7.3 Analog Functions

When the pin is used for analog purpose, make sure this pin is left floating by configuring `LP_IO_GPIO n _REG`. By such way, the external analog signal is directly connected to internal analog signal via GPIO pin. The configuration is as follows:

- Set `LP_AON_GPIO_MUX_SEL[n]`, to select LP IO MUX to route input and output signals.
- Clear `LP_GPIO_GPIO n _FUN_IE`, `LP_GPIO_GPIO n _FUN_RUE`, and `LP_GPIO_GPIO n _FUN_RDE`, to set the pin floating.
- Configure `LP_GPIO_GPIO n _FUN_SEL` to 0, i.e., select Analog Function 0;
- Write 1 to the corresponding bit in `LP_GPIO_ENABLE_W1TC`, to clear output enable.

See Table 7-5 for analog functions of LP GPIO pins.

7.8 Pin Functions in Light-sleep

Pins may provide different functions when ESP32-C6 is in Light-sleep mode. If `IO_MUX_GPIO n _SLP_SEL` in register `IO_MUX_GPIO n _REG` for a GPIO pin is set to 1, a different set of bits will be used to control the pin when the chip is in Light-sleep mode.

Table 7-1. Bit Used to Control IO MUX Functions in Light-sleep Mode

IO MUX Function	Normal Execution OR <code>IO_MUX_GPIOn_SLP_SEL = 0</code>	Light-sleep Mode AND <code>IO_MUX_GPIOn_SLP_SEL = 1</code>
Output Drive Strength	<code>IO_MUX_GPIOn_FUN_DRV</code>	<code>IO_MUX_GPIOn_MCU_DRV</code>
Pull-up Resistor	<code>IO_MUX_GPIOn_FUN_WPU</code>	<code>IO_MUX_GPIOn_MCU_WPU</code>
Pull-down Resistor	<code>IO_MUX_GPIOn_FUN_WPD</code>	<code>IO_MUX_GPIOn_MCU_WPD</code>
Input Enable	<code>IO_MUX_GPIOn_FUN_IE</code>	<code>IO_MUX_GPIOn_MCU_IE</code>
Output Enable	<code>OEN_SEL</code> from GPIO matrix *	<code>IO_MUX_GPIOn_MCU_OE</code>

Note:

If `IO_MUX_GPIO n _SLP_SEL` is set to 0, pin functions remain the same in both normal execution and in Light-sleep mode. Please refer to Section 7.5.2 for how to enable output in normal execution.

7.9 Pin Hold Feature

Each GPIO pin (including the LP pins: GPIO0 ~ GPIO7) has an individual hold function controlled by an LP register. When the pin is set to hold, the state is latched at that moment and will not change no matter how the internal signals change or how the IO MUX/GPIO configuration is modified. Users can use the hold function for the pins to retain the pin state through a core reset and system reset triggered by watchdog time-out or Deep-sleep events.

To use this feature, follow the steps below:

- Digital pins (GPIO8 ~ GPIO30):
 - To maintain pin input/output status in Deep-sleep mode, users can set `LP_AON_GPIO_HOLD0_REG[n]` to 1 before powering down. To disable the hold function after the chip is woken up, users can set `LP_AON_GPIO_HOLD0_REG[n]` to 0.
 - Or users can set `PMU_TIE_HIGH_HP_PAD_HOLD_ALL` to maintain the input/output status of all digital pins, and set `PMU_TIE_LOW_HP_PAD_HOLD_ALL` to disable the hold function of all digital pins.
- LP pins (GPIO0 ~ GPIO7):
 - The input and output values of LP GPIO pins are controlled by `LP_AON_GPIO_HOLD0_REG[n]`, `PMU_TIE_HIGH_LP_PAD_HOLD_ALL`, and `PMU_TIE_LOW_LP_PAD_HOLD_ALL`. Users can set `LP_AON_GPIO_HOLD0_REG[n]` to 1 to hold the value of GPIO n , or set `LP_AON_GPIO_HOLD0_REG[n]` to 0 to disable the hold function of GPIO n .
 - Or users can set `PMU_TIE_HIGH_LP_PAD_HOLD_ALL` to hold the values of all LP pins, and set `PMU_TIE_LOW_LP_PAD_HOLD_ALL` to disable the hold function of all LP pins.

7.10 Power Supplies and Management of GPIO Pins

7.10.1 Power Supplies of GPIO Pins

For more information on the power supply for GPIO pins, please refer to Pin Definition in [ESP32-C6 Datasheet](#). All the pins can be used to wake up the chip from Light-sleep mode, but only the pins (GPIO0 ~ GPIO7) in VDDPST1 domain can be used to wake up the chip from Deep-sleep mode.

7.10.2 Power Supply Management

Each ESP32-C6 pin is connected to one of the two different power domains.

- VDDPST1: the input power supply for LP GPIOs
- VDDPST2: the input power supply for digital GPIOs

7.11 Peripheral Signal List

Table 7-2 shows the peripheral input/output signals via GPIO matrix.

Please pay attention to the configuration of the bit `GPIO_FUNC n _OEN_SEL`:

- `GPIO_FUNC n _OEN_SEL` = 1: the output enable is controlled by the corresponding bit n of `GPIO_ENABLE_REG`:
 - `GPIO_ENABLE_REG` = 0: output is disabled;

- `GPIO_ENABLE_REG = 1`: output is enabled;
- `GPIO_FUNC n _OEN_SEL = 0`: use the output enable signal from peripheral, for example `SPIQ_oe` in the column “Output enable signal when `GPIO_FUNC n _OEN_SEL = 0`” of Table 7-2. Note that the signals such as `SPIQ_oe` can be 1 (1'd1) or 0 (1'd0), depending on the configuration of corresponding peripherals. If it's 1'd1 in column “Output enable signal when `GPIO_FUNC n _OEN_SEL = 0`”, it indicates that once `GPIO_FUNC n _OEN_SEL` is cleared, the output signal is always enabled by default.

Note:

Signals are numbered consecutively, but not all signals are valid.

- Only the signals with a name assigned in the column “Input signal” in Table 7-2 are valid input signals.
- Only the signals with a name assigned in the column “Output signal” in Table 7-2 are valid output signals.

Table 7-2. Peripheral Signals via GPIO Matrix

Signal No.	Input Signal	Default value	Direct Input via IO MUX	Output Signal	Output enable signal when <code>GPIO_FUNC_n_OEN_SEL = 0</code>	Direct Output via IO MUX
0	ext_adc_start	0	no	ledc_ls_sig_out0	1'd1	no
1	-	-	-	ledc_ls_sig_out1	1'd1	no
2	-	-	-	ledc_ls_sig_out2	1'd1	no
3	-	-	-	ledc_ls_sig_out3	1'd1	no
4	-	-	-	ledc_ls_sig_out4	1'd1	no
5	-	-	-	ledc_ls_sig_out5	1'd1	no
6	U0RXD_in	0	yes	U0TXD_out	1'd1	yes
7	U0CTS_in	0	no	U0RTS_out	1'd1	no
8	U0DSR_in	0	no	U0DTR_out	1'd1	no
9	U1RXD_in	1	no	U1TXD_out	1'd1	no
10	U1CTS_in	0	no	U1RTS_out	1'd1	no
11	U1DSR_in	0	no	U1DTR_out	1'd1	no
12	I2S_MCLK_in	0	no	I2S_MCLK_out	1'd1	no
13	I2SO_BCK_in	0	no	I2SO_BCK_out	1'd1	no
14	I2SO_WS_in	0	no	I2SO_WS_out	1'd1	no
15	I2SI_SD_in	0	no	I2SO_SD_out	1'd1	no
16	I2SI_BCK_in	0	no	I2SI_BCK_out	1'd1	no
17	I2SI_WS_in	0	no	I2SI_WS_out	1'd1	no
18	-	-	-	I2SO_SD1_out	1'd1	no
19	usb_jtag_tdo_bridge	0	no	usb_jtag_trst	1'd1	no
20	-	-	-	-	-	-
21	-	-	-	-	-	-
22	-	-	-	-	-	-
23	-	-	-	-	-	-
24	-	-	-	-	-	-

Signal No.	Input Signal	Default value	Direct Input via IO MUX	Output Signal	Output enable signal when GPIO_FUNCn_OEN_SEL = 0	Direct Output via IO MUX
25	-	-	-	-	-	-
26	-	-	-	-	-	-
27	-	-	-	-	-	-
28	cpu_gpio_in0	0	no	cpu_gpio_out0	cpu_gpio_out_oen0	no
29	cpu_gpio_in1	0	no	cpu_gpio_out1	cpu_gpio_out_oen1	no
30	cpu_gpio_in2	0	no	cpu_gpio_out2	cpu_gpio_out_oen2	no
31	cpu_gpio_in3	0	no	cpu_gpio_out3	cpu_gpio_out_oen3	no
32	cpu_gpio_in4	0	no	cpu_gpio_out4	cpu_gpio_out_oen4	no
33	cpu_gpio_in5	0	no	cpu_gpio_out5	cpu_gpio_out_oen5	no
34	cpu_gpio_in6	0	no	cpu_gpio_out6	cpu_gpio_out_oen6	no
35	cpu_gpio_in7	0	no	cpu_gpio_out7	cpu_gpio_out_oen7	no
36	-	-	-	-	-	-
37	-	-	-	-	-	-
38	-	-	-	-	-	-
39	-	-	-	-	-	-
40	-	-	-	-	-	-
41	-	-	-	-	-	-
42	-	-	-	-	-	-
43	-	-	-	-	-	-
44	-	-	-	-	-	-
45	I2CEXT0_SCL_in	1	no	I2CEXT0_SCL_out	I2CEXT0_SCL_oe	no
46	I2CEXT0_SDA_in	1	no	I2CEXT0_SDA_out	I2CEXT0_SDA_oe	no
47	parl_rx_data0	0	no	parl_tx_data0	1'd1	no
48	parl_rx_data1	0	no	parl_tx_data1	1'd1	no
49	parl_rx_data2	0	no	parl_tx_data2	1'd1	no
50	parl_rx_data3	0	no	parl_tx_data3	1'd1	no
51	parl_rx_data4	0	no	parl_tx_data4	1'd1	no

Signal No.	Input Signal	Default value	Direct Input via IO MUX	Output Signal	Output enable signal when GPIO_FUNCn_OEN_SEL = 0	Direct Output via IO MUX
52	parl_rx_data5	0	no	parl_tx_data5	1'd1	no
53	parl_rx_data6	0	no	parl_tx_data6	1'd1	no
54	parl_rx_data7	0	no	parl_tx_data7	1'd1	no
55	parl_rx_data8	0	no	parl_tx_data8	1'd1	no
56	parl_rx_data9	0	no	parl_tx_data9	1'd1	no
57	parl_rx_data10	0	no	parl_tx_data10	1'd1	no
58	parl_rx_data11	0	no	parl_tx_data11	1'd1	no
59	parl_rx_data12	0	no	parl_tx_data12	1'd1	no
60	parl_rx_data13	0	no	parl_tx_data13	1'd1	no
61	parl_rx_data14	0	no	parl_tx_data14	1'd1	no
62	parl_rx_data15	0	no	parl_tx_data15	1'd1	no
63	FSPICLK_in	0	yes	FSPICLK_out_mux	FSPICLK_oe	yes
64	FSPIQ_in	0	yes	FSPIQ_out	FSPIQ_oe	yes
65	FSPID_in	0	yes	FSPID_out	FSPID_oe	yes
66	FSPIHD_in	0	yes	FSPIHD_out	FSPIHD_oe	yes
67	FSPIWP_in	0	yes	FSPIWP_out	FSPIWP_oe	yes
68	FSPICS0_in	0	yes	FSPICS0_out	FSPICS0_oe	yes
69	parl_rx_clk_in	0	no	sdio_tohost_int_out	1'd1	no
70	parl_tx_clk_in	0	no	parl_tx_clk_out	1'd1	no
71	rmt_sig_in0	0	no	rmt_sig_out0	1'd1	no
72	rmt_sig_in1	0	no	rmt_sig_out1	1'd1	no
73	twai0_rx	1	no	twai0_tx	1'd1	no
74	-	-	-	twai0_bus_off_on	1'd1	no
75	-	-	-	twai0_clkout	1'd1	no
76	-	-	-	twai0_standby	1'd1	no
77	twai1_rx	1	no	twai1_tx	1'd1	no
78	-	-	-	twai1_bus_off_on	1'd1	no

Signal No.	Input Signal	Default value	Direct Input via IO MUX	Output Signal	Output enable signal when GPIO_FUNCn_OEN_SEL = 0	Direct Output via IO MUX
79	-	-	-	twai1_clkout	1'd1	no
80	-	-	-	twai1_standby	1'd1	no
81	-	-	-	-	-	-
82	-	-	-	-	-	-
83	-	-	-	gpio_sd0_out	1'd1	no
84	-	-	-	gpio_sd1_out	1'd1	no
85	-	-	-	gpio_sd2_out	1'd1	no
86	-	-	-	gpio_sd3_out	1'd1	no
87	pwm0_sync0_in	0	no	pwm0_out0a	1'd1	no
88	pwm0_sync1_in	0	no	pwm0_out0b	1'd1	no
89	pwm0_sync2_in	0	no	pwm0_out1a	1'd1	no
90	pwm0_f0_in	0	no	pwm0_out1b	1'd1	no
91	pwm0_f1_in	0	no	pwm0_out2a	1'd1	no
92	pwm0_f2_in	0	no	pwm0_out2b	1'd1	no
93	pwm0_cap0_in	0	no	-	-	-
94	pwm0_cap1_in	0	no	-	-	-
95	pwm0_cap2_in	0	no	-	-	-
96	-	-	-	-	-	-
97	sig_in_func_97	0	no	sig_in_func97	1'd1	no
98	sig_in_func_98	0	no	sig_in_func98	1'd1	no
99	sig_in_func_99	0	no	sig_in_func99	1'd1	no
100	sig_in_func_100	0	no	sig_in_func100	1'd1	no
101	pcnt_sig_ch0_in0	0	no	FSPICS1_out	FSPICS1_oe	yes
102	pcnt_sig_ch1_in0	0	no	FSPICS2_out	FSPICS2_oe	yes
103	pcnt_ctrl_ch0_in0	0	no	FSPICS3_out	FSPICS3_oe	yes
104	pcnt_ctrl_ch1_in0	0	no	FSPICS4_out	FSPICS4_oe	yes
105	pcnt_sig_ch0_in1	0	no	FSPICS5_out	FSPICS5_oe	yes

Signal No.	Input Signal	Default value	Direct Input via IO MUX	Output Signal	Output enable signal when GPIO_FUNCn_OEN_SEL = 0	Direct Output via IO MUX
106	pcnt_sig_ch1_in1	0	no	-	-	-
107	pcnt_ctrl_ch0_in1	0	no	-	-	-
108	pcnt_ctrl_ch1_in1	0	no	-	-	-
109	pcnt_sig_ch0_in2	0	no	-	-	-
110	pcnt_sig_ch1_in2	0	no	-	-	-
111	pcnt_ctrl_ch0_in2	0	no	-	-	-
112	pcnt_ctrl_ch1_in2	0	no	-	-	-
113	pcnt_sig_ch0_in3	0	no	-	-	-
114	pcnt_sig_ch1_in3	0	no	SPICLK_out_mux	SPICLK_oe	yes
115	pcnt_ctrl_ch0_in3	0	no	SPICS0_out	SPICS0_oe	yes
116	pcnt_ctrl_ch1_in3	0	no	SPICS1_out	SPICS1_oe	no
117	-	-	-	-	-	-
118	-	-	-	-	-	-
119	-	-	-	-	-	-
120	-	-	-	-	-	-
121	SPIQ_in	0	yes	SPIQ_out	SPIQ_oe	yes
122	SPID_in	0	yes	SPID_out	SPID_oe	yes
123	SPIHD_in	0	yes	SPIHD_out	SPIHD_oe	yes
124	SPIWP_in	0	yes	SPIWP_out	SPIWP_oe	yes
125	-	-	-	CLK_OUT_out1	1'd1	no
126	-	-	-	CLK_OUT_out2	1'd1	no
127	-	-	-	CLK_OUT_out3	1'd1	no

7.12 IO MUX Functions List

Table 7-3 shows the IO MUX functions of each GPIO pin.

Table 7-3. IO MUX Functions List

GPIO	Pin Name	Function 0	Function 1	Function 2	Function 3	DRV	Reset	Notes
0	XTAL_32K_P	GPIO0	GPIO0	—	—	2	0	R
1	XTAL_32K_N	GPIO1	GPIO1	—	—	2	0	R
2	GPIO2	GPIO2	GPIO2	FSPIQ	—	2	1	R
3	GPIO3	GPIO3	GPIO3	—	—	2	1	R
4	MTMS	MTMS	GPIO4	FSPIHD	—	2	1	R
5	MTDI	MTDI	GPIO5	FSPiWP	—	2	1	R
6	MTCK	MTCK	GPIO6	FSPiCLK	—	2	1*	R
7	MTDO	MTDO	GPIO7	FSPiD	—	2	1	R
8	GPIO8	GPIO8	GPIO8	—	—	2	1	—
9	GPIO9	GPIO9	GPIO9	—	—	2	3	—
10	GPIO10	GPIO10	GPIO10	—	—	2	1	S1
11	GPIO11	GPIO11	GPIO11	—	—	2	1	S1
12	GPIO12	GPIO12	GPIO12	—	—	3	1	USB
13	GPIO13	GPIO13	GPIO13	—	—	3	3	USB
14	GPIO14	GPIO14	GPIO14	—	—	2	1	S0
15	GPIO15	GPIO15	GPIO15	—	—	2	1	—
16	U0TXD	U0TXD	GPIO16	FSPiCS0	—	2	4	—
17	U0RXD	U0RXD	GPIO17	FSPiCS1	—	2	3	—
18	SDIO_CMD	SDIO_CMD	GPIO18	FSPiCS2	—	2	3	—
19	SDIO_CLK	SDIO_CLK	GPIO19	FSPiCS3	—	2	3	—
20	SDIO_DATA0	SDIO_DATA0	GPIO20	FSPiCS4	—	2	3	—
21	SDIO_DATA1	SDIO_DATA1	GPIO21	FSPiCS5	—	2	3	—
22	SDIO_DATA2	SDIO_DATA2	GPIO22	—	—	2	3	—
23	SDIO_DATA3	SDIO_DATA3	GPIO23	—	—	2	3	—
24	SPiCS0	SPiCS0	GPIO24	—	—	2	3	S1, S2
25	SPiQ	SPiQ	GPIO25	—	—	2	3	S1, S2
26	SPiWP	SPiWP	GPIO26	—	—	2	3	S1, S2
27	VDD_SPI	GPIO27	GPIO27	—	—	2	0	S1, S2
28	SPiHD	SPiHD	GPIO28	—	—	2	3	S1, S2
29	SPiCLK	SPiCLK	GPIO29	—	—	2	3	S1, S2
30	SPiD	SPiD	GPIO30	—	—	2	3	S1, S2

Drive Strength

“DRV” column shows the drive strength of each pin after reset:

- **0** - Drive current = ~5 mA
- **1** - Drive current = ~10 mA
- **2** - Drive current = ~20 mA

- **3** - Drive current = ~40 mA

Reset Configurations

“Reset” column shows the default configuration of each pin after reset:

- **0** - IE = 0 (input disabled)
- **1** - IE = 1 (input enabled)
- **2** - IE = 1, WPD = 1 (input enabled, pull-down resistor enabled)
- **3** - IE = 1, WPU = 1 (input enabled, pull-up resistor enabled)
- **4** - OE = 1, WPU = 1 (output enabled, pull-up resistor enabled)
- **1*** - If [EFUSE_DIS_PAD_JTAG](#) = 1, the pin MTCK is left floating after reset, i.e., IE = 1. If [EFUSE_DIS_PAD_JTAG](#) = 0, the pin MTCK is connected to internal pull-up resistor, i.e., IE = 1, WPU = 1.

Note:

- **R** - Pins in VDDPST1 domain, and part of them have analog functions, see [Table 7-5](#).
- **USB** - GPIO12 and GPIO13 are USB pins. The pull-up value of the two pins are controlled by the pins' pull-up value together with USB pull-up value. If any one of the pull-up value is 1, the pin's pull-up resistor will be enabled. The pull-up resistors of USB pins are controlled by [USB_SERIAL_JTAG_DP_PULLUP](#).
- **S0** - For chip variants without an in-package flash, this pin can not be used.
- **S1** - For chip variants with an in-package flash, this pin can not be used.
- **S2** - For chip variants with an in-package flash, this pin can only be used to connect the in-package flash, i.e., only Function 0 is available. For chip variants without an in-package flash, this pin can be used as a normal pin, i.e., all the functions are available.

7.13 LP IO MUX Functions List

Table 7-4 shows the LP GPIO pins and how they correspond to GPIO pins and LP functions.

Table 7-4. LP IO MUX Functions List

LP GPIO No.	GPIO No.	GPIO Pin	LP Functions	
			0	1
0	0	XTAL_32K_P	LP_GPIO0	lp_uart_dtrn ¹
1	1	XTAL_32K_N	LP_GPIO1	lp_uart_dsrn ¹
2	2	GPIO2	LP_GPIO2	lp_uart_rtsn ¹
3	3	GPIO3	LP_GPIO3	lp_uart_ctsn ¹
4	4	MTMS	LP_GPIO4	lp_uart_rxd ¹
5	5	MTDI	LP_GPIO5	lp_uart_txd ¹
6	6	MTCK	LP_GPIO6	lp_i2c_sda ²
7	7	MTDO	LP_GPIO7	lp_i2c_scl ²

¹ For the configuration of lp_uart_xx, please refer to Section: *LP UART Controller* in Chapter 3 *Low-Power CPU*.

² For the configuration of sar_i2c_xx, please refer to Section: *LP I2C Controller* in Chapter 3 *Low-Power CPU*.

Table 7-5 shows the LP GPIO pins and how they correspond to GPIO pins and analog functions.

Table 7-5. Analog Functions of IO MUX Pins

LP GPIO No. ¹	GPIO No. ¹	Pin Name	Analog Function 0	Analog Function 1
0	0	XTAL_32K_P	XTAL_32K_P	ADC1_CH0
1	1	XTAL_32K_N	XTAL_32K_N	ADC1_CH1
2	2	GPIO2	-	ADC1_CH2
3	3	GPIO3	-	ADC1_CH3
4	4	MTMS	-	ADC1_CH4
5	5	MTDI	-	ADC1_CH5
6	6	MTCK	-	ADC1_CH6
-	12	GPIO12 ²	USB_D-	-
-	13	GPIO13 ²	USB_D+	-

¹ In this table, LP GPIO No. and GPIO No. are used, not the pin No.

² GPIO12 and GPIO13 are not LP GPIO.

7.14 ETM Event and Task

For the detailed description of ETM features, please refer to Chapter 11 *Event Task Matrix (SOC_ETM)*.

7.14.1 ETM Event

The GPIO ETM feature supports eight event channels. To enable this feature, follow the steps below:

- Set `GPIOSD_ETM_CHx_EVENT_EN` to enable event channel x (0 ~ 7).
- Configure `GPIOSD_ETM_CHx_EVENT_SEL` to y (0 ~ 30), i.e., select one from the 31 GPIOs.

Event channel x has the following signals:

- `GPIO_EVT_CHx_RISE_EDGE`: the rising edge of the output signal from the GPIO Filter (see Figure 7-1).
- `GPIO_EVT_CHx_FALL_EDGE`: the falling edge of the output signal from the GPIO Filter (see Figure 7-1).
- `GPIO_EVT_CHx_ANY_EDGE`: any edge of the output signal from the GPIO Filter (see Figure 7-1).

The above signals are sent to SOC_ETM as events.

Note:

One GPIO can be selected by one or more event channels.

7.14.2 ETM Task

The GPIO ETM provides eight task channels x (0 ~ 7). Each channel has the following signals:

- `GPIO_TASK_CHx_SET`: controls the GPIO to high level;
- `GPIO_TASK_CHx_CLEAR`: controls the GPIO to low level;
- `GPIO_TASK_CHx_TOGGLE`: inverts the GPIO's level.

Below is an example to configure task channel x to control GPIO y :

- Configure `IO_MUX_GPIOy MCU_SEL` to 1, to select Function 1 listed in Table 7-3;
- Configure `GPIO_ENABLE_REG[y]` to 1;
- Configure `GPIOSD_ETM_TASK_GPIOy_SEL` to `x`;
- Set `GPSD_ETM_TASK_GPIOy_EN`, to enable ETM task channel `x` to control `GPIOy`.

Note:

- One task channel can be selected by one or more GPIOs.
- When two or three of the signals `GPIO_TASK_CHx_SET`, `GPIO_TASK_CHx_CLEAR`, and `GPIO_TASK_CHx_TOGGLE` of the task channel `x` selected by `GPIOy` are valid at the same time, then `GPIO_TASK_CHx_SET` has the highest priority, `GPIO_TASK_CHx_CLEAR` takes the second higher priority, and `GPIO_TASK_CHx_TOGGLE` has the lowest priority.
- When `GPIOy` is controlled by ETM task channel, the values of `GPIO_OUT_REG`, `GPIO_FUNCn_OUT_INV_SEL`, and `GPIO_FUNCn_OUT_SEL` may be modified by the hardware. For such reason, it's recommended to reconfigure these registers when the GPIO is free from the control of ETM task channel.

7.15 Register Summary

7.15.1 GPIO Matrix Register Summary

The addresses in this section are relative to GPIO base address provided in Table 5-2 in Chapter 5 *System and Memory*.

The abbreviations given in Column **Access** are explained in Section *Access Types for Registers*.

Note: For chip variants with an in-package flash, 22 GPIO pins are available, i.e., GPIO0 ~ GPIO9 and GPIO12 ~ GPIO23. For this case:

- **Configuration Registers:** can only be configured for GPIO0 ~ GPIO9 and GPIO12 ~ GPIO23.
- **Pin Configuration Registers:** only `GPIO_PIN0_REG` ~ `GPIO_PIN9_REG` and `GPIO_PIN12_REG` ~ `GPIO_PIN23_REG` are available.
- **Input Configuration Registers:** can only be configured for GPIO0 ~ GPIO9 and GPIO12 ~ GPIO23.
- **Output Configuration Registers:** only `GPIO_FUNC0_OUT_SEL_CFG_REG` ~ `GPIO_FUNC9_OUT_SEL_CFG_REG` and `GPIO_PIN12_OUT_SEL_CFG_REG` ~ `GPIO_PIN23_OUT_SEL_CFG_REG` are available.

Name	Description	Address	Access
Configuration Registers			
<code>GPIO_OUT_REG</code>	GPIO output register	0x0004	R/W/SC/WTC
<code>GPIO_OUT_W1TS_REG</code>	GPIO output set register	0x0008	WT
<code>GPIO_OUT_W1TC_REG</code>	GPIO output clear register	0x000C	WT
<code>GPIO_ENABLE_REG</code>	GPIO output enable register	0x0020	R/W/WTC
<code>GPIO_ENABLE_W1TS_REG</code>	GPIO output enable set register	0x0024	WT
<code>GPIO_ENABLE_W1TC_REG</code>	GPIO output enable clear register	0x0028	WT
<code>GPIO_STRAP_REG</code>	Strapping pin register	0x0038	RO
<code>GPIO_IN_REG</code>	GPIO input register	0x003C	RO

Name	Description	Address	Access
Interrupt Status Registers			
GPIO_STATUS_REG	GPIO interrupt status register	0x0044	R/W/WTC
GPIO_STATUS_W1TS_REG	GPIO interrupt status set register	0x0048	WT
GPIO_STATUS_W1TC_REG	GPIO interrupt status clear register	0x004C	WT
GPIO_PCPU_INT_REG	GPIO CPU interrupt status register	0x005C	RO
GPIO_PCPU_NMI_INT_REG	GPIO CPU non-maskable interrupt status register	0x0060	RO
GPIO_STATUS_NEXT_REG	GPIO interrupt source register	0x014C	RO
Pin Configuration Registers			
GPIO_PIN0_REG	GPIO0 configuration register	0x0074	R/W
GPIO_PIN1_REG	GPIO1 configuration register	0x0078	R/W
GPIO_PIN2_REG	GPIO2 configuration register	0x007C	R/W
...
GPIO_PIN28_REG	GPIO28 configuration register	0x00E4	R/W
GPIO_PIN29_REG	GPIO29 configuration register	0x00E8	R/W
GPIO_PIN30_REG	GPIO30 configuration register	0x00EC	R/W
Input Configuration Registers			
GPIO_FUNC0_IN_SEL_CFG_REG	Configuration register for input signal 0	0x0154	R/W
GPIO_FUNC1_IN_SEL_CFG_REG	Configuration register for input signal 1	0x0158	R/W
GPIO_FUNC2_IN_SEL_CFG_REG	Configuration register for input signal 2	0x015C	R/W
...
GPIO_FUNC125_IN_SEL_CFG_REG	Configuration register for input signal 125	0x0348	R/W
GPIO_FUNC126_IN_SEL_CFG_REG	Configuration register for input signal 126	0x034C	R/W
GPIO_FUNC127_IN_SEL_CFG_REG	Configuration register for input signal 127	0x0350	R/W
Output Configuration Registers			
GPIO_FUNC0_OUT_SEL_CFG_REG	Configuration register for GPIO0 output	0x0554	varies
GPIO_FUNC1_OUT_SEL_CFG_REG	Configuration register for GPIO1 output	0x0558	varies
GPIO_FUNC2_OUT_SEL_CFG_REG	Configuration register for GPIO2 output	0x055C	varies
...
GPIO_FUNC28_OUT_SEL_CFG_REG	Configuration register for GPIO28 output	0x05C4	varies
GPIO_FUNC29_OUT_SEL_CFG_REG	Configuration register for GPIO29 output	0x05C8	varies
GPIO_FUNC30_OUT_SEL_CFG_REG	Configuration register for GPIO30 output	0x05CC	varies
Version Register			
GPIO_DATE_REG	GPIO version register	0x06FC	R/W
Clock Gate Register			
GPIO_CLOCK_GATE_REG	GPIO clock gate register	0x062C	R/W

7.15.2 IO MUX Register Summary

The addresses in this section are relative to the IO MUX base address provided in Table 5-2 in Chapter 5 *System and Memory*.

Note: For chip variants with an in-package flash, only 22 GPIO pins are available, i.e., GPIO0 ~ GPIO9 and GPIO12 ~ GPIO23. For this case, **Configuration Registers** of [IO_MUX_GPIO10_REG](#) ~ [IO_MUX_GPIO11_REG](#) and [IO_MUX_GPIO24_REG](#) ~ [IO_MUX_GPIO30_REG](#) are not configurable.

The abbreviations given in Column **Access** are explained in Section [Access Types for Registers](#).

Name	Description	Address	Access
Configuration Registers			
IO_MUX_PIN_CTRL_REG	Clock output configuration register	0x0000	R/W
IO_MUX_GPIO0_REG	IO MUX configuration register for GPIO0	0x0004	R/W
IO_MUX_GPIO1_REG	IO MUX configuration register for GPIO1	0x0008	R/W
IO_MUX_GPIO2_REG	IO MUX configuration register for GPIO2	0x000C	R/W
IO_MUX_GPIO3_REG	IO MUX configuration register for GPIO3	0x0010	R/W
IO_MUX_GPIO4_REG	IO MUX configuration register for GPIO4	0x0014	R/W
IO_MUX_GPIO5_REG	IO MUX configuration register for GPIO5	0x0018	R/W
IO_MUX_GPIO6_REG	IO MUX configuration register for GPIO6	0x001C	R/W
IO_MUX_GPIO7_REG	IO MUX configuration register for GPIO7	0x0020	R/W
IO_MUX_GPIO8_REG	IO MUX configuration register for GPIO8	0x0024	R/W
IO_MUX_GPIO9_REG	IO MUX configuration register for GPIO9	0x0028	R/W
IO_MUX_GPIO10_REG	IO MUX configuration register for GPIO10	0x002C	R/W
IO_MUX_GPIO11_REG	IO MUX configuration register for GPIO11	0x0030	R/W
IO_MUX_GPIO12_REG	IO MUX configuration register for GPIO12	0x0034	R/W
IO_MUX_GPIO13_REG	IO MUX configuration register for GPIO13	0x0038	R/W
IO_MUX_GPIO14_REG	IO MUX configuration register for GPIO14	0x003C	R/W
IO_MUX_GPIO15_REG	IO MUX configuration register for GPIO15	0x0040	R/W
IO_MUX_GPIO16_REG	IO MUX configuration register for GPIO16	0x0044	R/W
IO_MUX_GPIO17_REG	IO MUX configuration register for GPIO17	0x0048	R/W
IO_MUX_GPIO18_REG	IO MUX configuration register for GPIO18	0x004C	R/W
IO_MUX_GPIO19_REG	IO MUX configuration register for GPIO19	0x0050	R/W
IO_MUX_GPIO20_REG	IO MUX configuration register for GPIO20	0x0054	R/W
IO_MUX_GPIO21_REG	IO MUX configuration register for GPIO21	0x0058	R/W
IO_MUX_GPIO22_REG	IO MUX configuration register for GPIO22	0x005C	R/W
IO_MUX_GPIO23_REG	IO MUX configuration register for GPIO23	0x0060	R/W
IO_MUX_GPIO24_REG	IO MUX configuration register for GPIO24	0x0064	R/W
IO_MUX_GPIO25_REG	IO MUX configuration register for GPIO25	0x0068	R/W
IO_MUX_GPIO26_REG	IO MUX configuration register for GPIO26	0x006C	R/W
IO_MUX_GPIO27_REG	IO MUX configuration register for GPIO27	0x0070	R/W
IO_MUX_GPIO28_REG	IO MUX configuration register for GPIO28	0x0074	R/W
IO_MUX_GPIO29_REG	IO MUX configuration register for GPIO29	0x0078	R/W
IO_MUX_GPIO30_REG	IO MUX configuration register for GPIO30	0x007C	R/W
Version Register			
IO_MUX_DATE_REG	Version control register	0x00FC	R/W

7.15.3 Sub Design Register Summary

Sub Design (SD) registers consist of SDM registers, Glitch Filter registers, and ETM registers.

The addresses in this section are relative to (GPIO base address + 0x0F00). GPIO base address is provided in Table 5-2 in Chapter 5 [System and Memory](#).

The abbreviations given in Column **Access** are explained in Section [Access Types for Registers](#).

Name	Description	Address	Access
SDM Configure Registers			
GPIOSD_SIGMADELTA0_REG	Duty cycle configuration register for SDM channel 0	0x0000	R/W
GPIOSD_SIGMADELTA1_REG	Duty cycle configuration register for SDM channel 1	0x0004	R/W
GPIOSD_SIGMADELTA2_REG	Duty cycle configuration register for SDM channel 2	0x0008	R/W
GPIOSD_SIGMADELTA3_REG	Duty cycle configuration register for SDM channel 3	0x000C	R/W
GPIOSD_SIGMADELTA_MISC_REG	MISC register	0x0024	R/W
Glitch Filter Configuration Registers			
GPIOSD_GLITCH_FILTER_CH0_REG	Glitch Filter configuration register for channel 0	0x0030	R/W
GPIOSD_GLITCH_FILTER_CH1_REG	Glitch Filter configuration register for channel 1	0x0034	R/W
GPIOSD_GLITCH_FILTER_CH2_REG	Glitch Filter configuration register for channel 2	0x0038	R/W
GPIOSD_GLITCH_FILTER_CH3_REG	Glitch Filter configuration register for channel 3	0x003C	R/W
GPIOSD_GLITCH_FILTER_CH4_REG	Glitch Filter configuration register for channel 4	0x0040	R/W
GPIOSD_GLITCH_FILTER_CH5_REG	Glitch Filter configuration register for channel 5	0x0044	R/W
GPIOSD_GLITCH_FILTER_CH6_REG	Glitch Filter configuration register for channel 6	0x0048	R/W
GPIOSD_GLITCH_FILTER_CH7_REG	Glitch Filter configuration register for channel 7	0x004C	R/W
ETM Configuration Registers			
GPIOSD_ETM_EVENT_CH0_CFG_REG	ETM configuration register for channel 0	0x0060	R/W
GPIOSD_ETM_EVENT_CH1_CFG_REG	ETM configuration register for channel 1	0x0064	R/W
GPIOSD_ETM_EVENT_CH2_CFG_REG	ETM configuration register for channel 2	0x0068	R/W
GPIOSD_ETM_EVENT_CH3_CFG_REG	ETM configuration register for channel 3	0x006C	R/W
GPIOSD_ETM_EVENT_CH4_CFG_REG	ETM configuration register for channel 4	0x0070	R/W
GPIOSD_ETM_EVENT_CH5_CFG_REG	ETM configuration register for channel 5	0x0074	R/W
GPIOSD_ETM_EVENT_CH6_CFG_REG	ETM configuration register for channel 6	0x0078	R/W
GPIOSD_ETM_EVENT_CH7_CFG_REG	ETM configuration register for channel 7	0x007C	R/W
GPIOSD_ETM_TASK_P0_CFG_REG	GPIO selection register 0 for ETM	0x00A0	R/W
GPIOSD_ETM_TASK_P1_CFG_REG	GPIO selection register 1 for ETM	0x00A4	R/W
GPIOSD_ETM_TASK_P2_CFG_REG	GPIO selection register 2 for ETM	0x00A8	R/W
GPIOSD_ETM_TASK_P3_CFG_REG	GPIO selection register 3 for ETM	0x00AC	R/W
GPIOSD_ETM_TASK_P4_CFG_REG	GPIO selection register 4 for ETM	0x00B0	R/W
GPIOSD_ETM_TASK_P5_CFG_REG	GPIO selection register 5 for ETM	0x00B4	R/W
GPIOSD_ETM_TASK_P6_CFG_REG	GPIO selection register 6 for ETM	0x00B8	R/W
GPIOSD_ETM_TASK_P7_CFG_REG	GPIO selection register 7 for ETM	0x00BC	R/W
Version Register			
GPIOSD_VERSION_REG	Version control register	0x00FC	R/W

7.15.4 LP IO MUX Register Summary

The addresses in this section are relative to LP_IO base address provided in Table 5-2 in Chapter 5 *System and Memory*.

The abbreviations given in Column **Access** are explained in Section *Access Types for Registers*.

Name	Description	Address	Access
GPIO Configuration/Data Registers			
LP_IO_OUT_REG	LP GPIO output register	0x0000	R/W
LP_IO_OUT_W1TS_REG	LP GPIO output set register	0x0004	WT
LP_IO_OUT_W1TC_REG	LP GPIO output clear register	0x0008	WT
LP_IO_ENABLE_REG	LP GPIO output enable register	0x000C	R/W
LP_IO_ENABLE_W1TS_REG	LP GPIO output enable set register	0x0010	WT
LP_IO_ENABLE_W1TC_REG	LP GPIO output enable clear register	0x0014	WT
LP_IO_STATUS_REG	LP GPIO interrupt status register	0x0018	R/W
LP_IO_STATUS_W1TS_REG	LP GPIO interrupt status set register	0x001C	WT
LP_IO_STATUS_W1TC_REG	LP GPIO interrupt status clear register	0x0020	WT
LP_IO_IN_REG	LP GPIO input register	0x0024	RO
LP_IO_PIN0_REG	LP GPIO0 configuration register	0x0028	R/W
LP_IO_PIN1_REG	LP GPIO1 configuration register	0x002C	R/W
LP_IO_PIN2_REG	LP GPIO2 configuration register	0x0030	R/W
LP_IO_PIN3_REG	LP GPIO3 configuration register	0x0034	R/W
LP_IO_PIN4_REG	LP GPIO4 configuration register	0x0038	R/W
LP_IO_PIN5_REG	LP GPIO5 configuration register	0x003C	R/W
LP_IO_PIN6_REG	LP GPIO6 configuration register	0x0040	R/W
LP_IO_PIN7_REG	LP GPIO7 configuration register	0x0044	R/W
GPIO LP Function Configuration Registers			
LP_IO_GPIO0_REG	LP IO MUX configuration register for GPIO0	0x0048	R/W
LP_IO_GPIO1_REG	LP IO MUX configuration register for GPIO1	0x004C	R/W
LP_IO_GPIO2_REG	LP IO MUX configuration register for GPIO2	0x0050	R/W
LP_IO_GPIO3_REG	LP IO MUX configuration register for GPIO3	0x0054	R/W
LP_IO_GPIO4_REG	LP IO MUX configuration register for GPIO4	0x0058	R/W
LP_IO_GPIO5_REG	LP IO MUX configuration register for GPIO5	0x005C	R/W
LP_IO_GPIO6_REG	LP IO MUX configuration register for GPIO6	0x0060	R/W
LP_IO_GPIO7_REG	LP IO MUX configuration register for GPIO7	0x0064	R/W
LP_IO_STATUS_INT_REG	LP GPIO interrupt source register	0x0068	RO
Version Register			
LP_IO_DATE_REG	Version control register	0x03FC	R/W

7.16 Registers

7.16.1 GPIO Matrix Registers

The addresses in this section are relative to GPIO base address provided in Table 5-2 in Chapter 5 *System and Memory*.

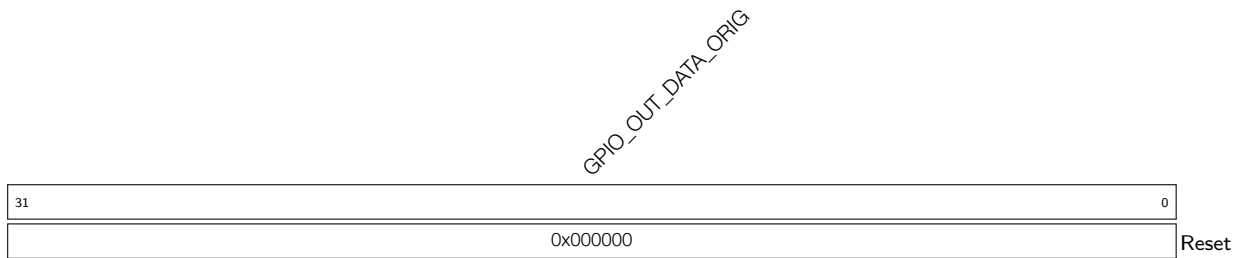
Register 7.1. GPIO_OUT_REG (0x0004)

GPIO_OUT_DATA_ORIG Configures the output value of GPIO0 ~ 30 output in simple GPIO output mode.

0: Low level

1: High level

The value of bit0 ~ bit30 correspond to the output value of GPIO0 ~ GPIO30 respectively. Bit31 is invalid.

(R/W/SC/WTC)

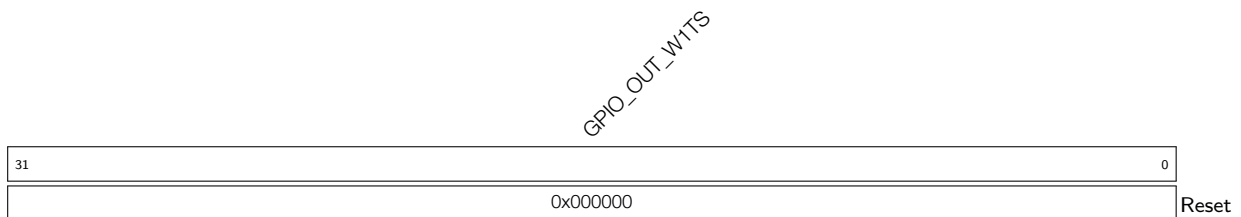
Register 7.2. GPIO_OUT_W1TS_REG (0x0008)

GPIO_OUT_W1TS Configures whether or not to set the output register [GPIO_OUT_REG](#) of GPIO0 ~ GPIO30.

0: Not set

1: The corresponding bit in [GPIO_OUT_REG](#) will be set to 1

Bit0 ~ bit30 are corresponding to GPIO0 ~ GPIO30. Bit31 is invalid. Recommended operation: use this register to set [GPIO_OUT_REG](#).

(WT)

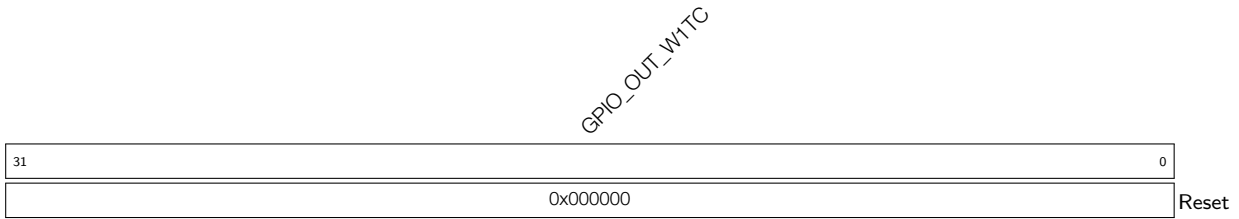
Register 7.3. GPIO_OUT_W1TC_REG (0x000C)

GPIO_OUT_W1TC Configures whether or not to clear the output register [GPIO_OUT_REG](#) of GPIO0 ~ GPIO30 output.

0: Not clear

1: The corresponding bit in [GPIO_OUT_REG](#) will be cleared.

Bit0 ~ bit30 are corresponding to GPIO0 ~ GPIO30. Bit31 is invalid. Recommended operation: use this register to clear [GPIO_OUT_REG](#).

(WT)

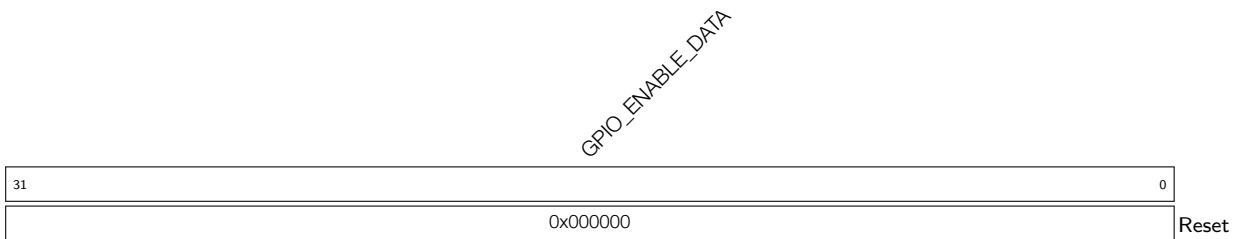
Register 7.4. GPIO_ENABLE_REG (0x0020)

GPIO_ENABLE_DATA Configures whether or not to enable the output of GPIO0 ~ GPIO30.

0: Not enable

1: Enable

Bit0 ~ bit30 are corresponding to GPIO0 ~ GPIO30. Bit31 is invalid.

(R/W/WTC)

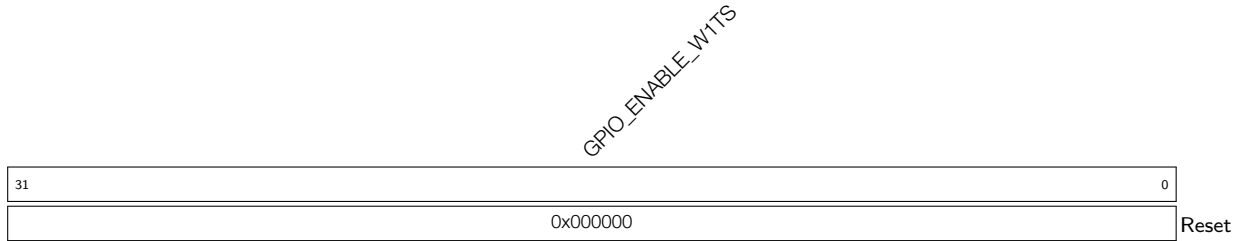
Register 7.5. GPIO_ENABLE_W1TS_REG (0x0024)

GPIO_ENABLE_W1TS Configures whether or not to set the output enable register [GPIO_ENABLE_REG](#) of GPIO0 ~ GPIO30.

0: Not set

1: The corresponding bit in [GPIO_ENABLE_REG](#) will be set to 1

Bit0 ~ bit30 are corresponding to GPIO0 ~ GPIO30. Bit31 is invalid. Recommended operation: use this register to set [GPIO_ENABLE_REG](#).

(WT)

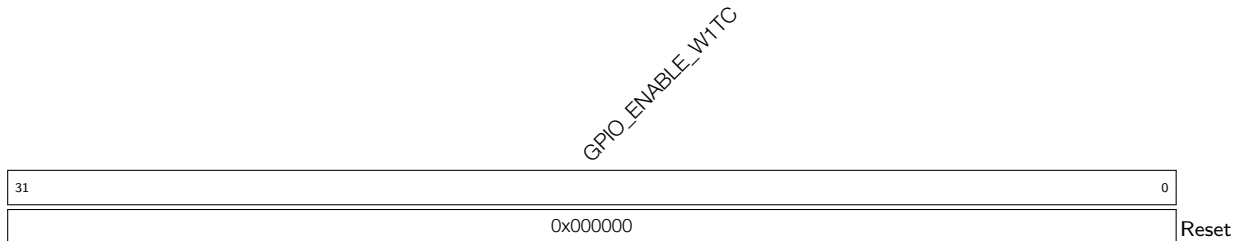
Register 7.6. GPIO_ENABLE_W1TC_REG (0x0028)

GPIO_ENABLE_W1TC Configures whether or not to clear the output enable register [GPIO_ENABLE_REG](#) of GPIO0 ~ GPIO30.

0: Not clear

1: The corresponding bit in [GPIO_ENABLE_REG](#) will be cleared

Bit0 ~ bit30 are corresponding to GPIO0 ~ 30. Bit31 is invalid. Recommended operation: use this register to clear [GPIO_ENABLE_REG](#).

(WT)

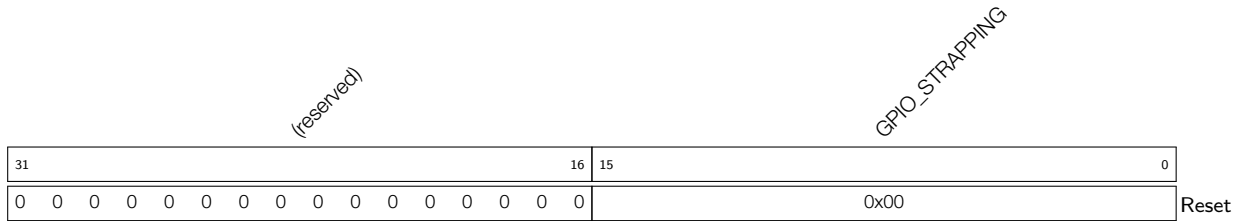
Register 7.7. GPIO_STRAP_REG (0x0038)

GPIO_STRAPPING Represents the values of GPIO strapping pins.

- bit0 ~ bit1: invalid
- bit2: GPIO8
- bit3: GPIO9
- bit4: GPIO15
- bit5: MTMS
- bit6: MTDI
- bit7 ~ bit15: invalid

(RO)

Register 7.8. GPIO_IN_REG (0x003C)

GPIO_IN_DATA_NEXT Represents the input value of GPIO0 ~ GPIO30. Each bit represents a pin

input value:

0: Low level

1: High level

Bit0 ~ bit30 are corresponding to GPIO0 ~ GPIO30. Bit31 is invalid.

(RO)

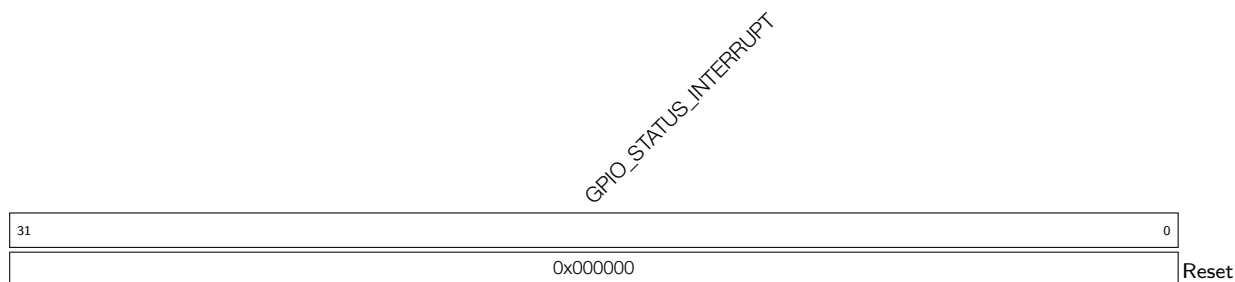
Register 7.9. GPIO_STATUS_REG (0x0044)

GPIO_STATUS_INTERRUPT The interrupt status of GPIO0 ~ GPIO30, can be configured by the software.

- Bit0 ~ bit30 are corresponding to GPIO0 ~ GPIO30. Bit31 is invalid.
- Each bit represents the status of its corresponding GPIO:
 - 0: Represents the GPIO does not generate the interrupt configured by [GPIO_PIN \$n\$ _INT_TYPE](#), or this bit is configured to 0 by the software.
 - 1: Represents the GPIO generates the interrupt configured by [GPIO_PIN \$n\$ _INT_TYPE](#), or this bit is configured to 1 by the software.

(R/W/WTC)

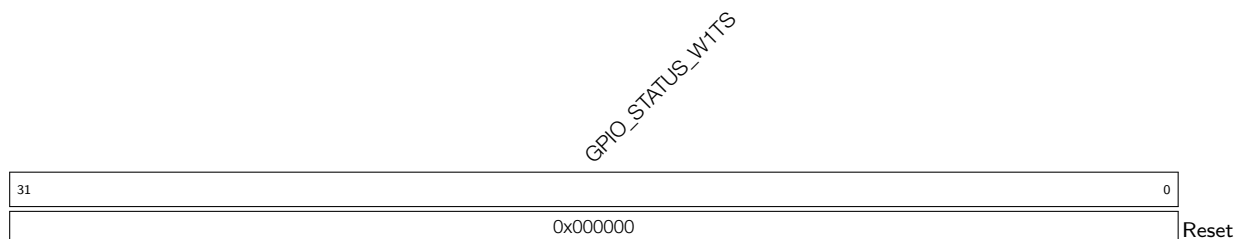
Register 7.10. GPIO_STATUS_W1TS_REG (0x0048)

GPIO_STATUS_W1TS Configures whether or not to set the interrupt status register [GPIO_STATUS_INTERRUPT](#) of GPIO0 ~ GPIO30.

- Bit0 ~ bit30 are corresponding to GPIO0 ~ GPIO30. Bit31 is invalid.
- If the value 1 is written to a bit here, the corresponding bit in [GPIO_STATUS_INTERRUPT](#) will be set to 1.
- Recommended operation: use this register to set [GPIO_STATUS_INTERRUPT](#).

(WT)

Register 7.11. GPIO_STATUS_W1TC_REG (0x004C)

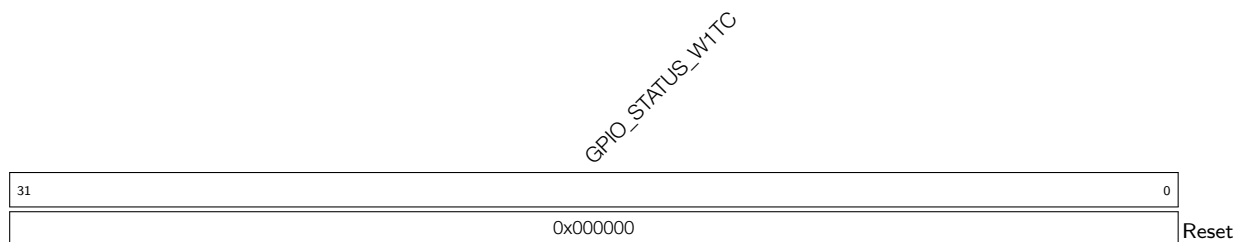

GPIO_STATUS_W1TC Configures whether or not to clear the interrupt status register [GPIO_STATUS_INTERRUPT](#) of GPIO0 ~ GPIO30.

- Bit0 ~ bit30 are corresponding to GPIO0 ~ GPIO30. Bit31 is invalid.
- If the value 1 is written to a bit here, the corresponding bit in [GPIO_STATUS_INTERRUPT](#) will be cleared.
- Recommended operation: use this register to clear [GPIO_STATUS_INTERRUPT](#).

(WT)

Register 7.12. GPIO_PROCPU_INT_REG (0x005C)

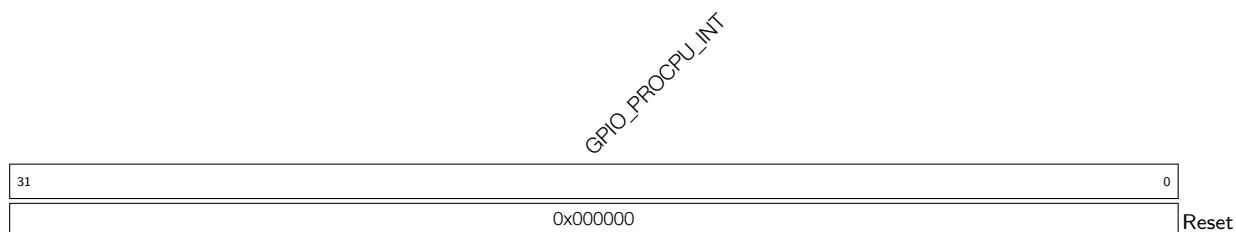

GPIO_PROCPU_INT Represents the CPU interrupt status of GPIO0 ~ GPIO30. Each bit represents:
 0: Represents CPU interrupt is not enabled, or the GPIO does not generate the interrupt configured by [GPIO_PIN_n_INT_TYPE](#).

1: Represents the GPIO generates an interrupt configured by [GPIO_PIN_n_INT_TYPE](#) after the CPU interrupt is enabled.

Bit0 ~ bit30 are corresponding to GPIO0 ~ GPIO30. Bit31 is invalid. This interrupt status is corresponding to the bit in [GPIO_STATUS_REG](#) when assert (high) enable signal (bit13 of [GPIO_PIN_n_REG](#)).

(RO)

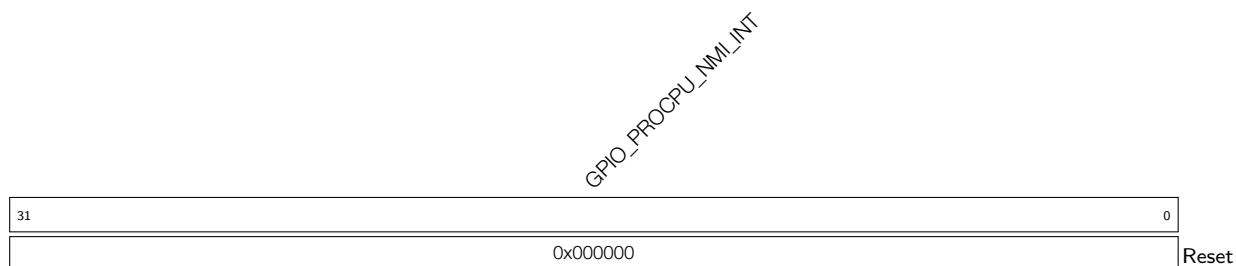
Register 7.13. GPIO_PCPU_NMI_INT_REG (0x0060)

GPIO_PROCPU_NMI_INT Represents the CPU non-maskable interrupt status of GPIO0 ~ GPIO30.

Each bit represents:

0: Represents CPU non-maskable interrupt is disabled, or the GPIO does not generate the interrupt configured by [GPIO_PIN_n_INT_TYPE](#).

1: Represents the GPIO generates an interrupt configured by [GPIO_PIN_n_INT_TYPE](#) after CPU non-maskable interrupt is enabled.

Bit0 ~ bit30 are corresponding to GPIO0 ~ GPIO30.

This interrupt status is corresponding to the bit in [GPIO_STATUS_REG](#) when assert (high) enable signal (bit 14 of [GPIO_PIN_n_REG](#)).

(RO)

Register 7.14. GPIO_PIN n _REG (n : 0-30) (0x0074+4* n)

(reserved)										GPIO_PIN n _INT_ENA			(reserved)	GPIO_PIN n _WAKEUP_ENABLE		GPIO_PIN n _INT_TYPE			(reserved)	GPIO_PIN n _SYNC1_BYPASS		GPIO_PIN n _PAD_DRIVER		GPIO_PIN n _SYNC2_BYPASS						
31										18	17					13	12	11	10	9			7	6	5	4	3	2	1	0
0 0 0 0 0 0 0 0 0 0										0x0			0x0	0		0x0		0	0	0x0	0	0	0x0	0	0x0	0	0x0	0	0x0	Reset

GPIO_PIN n _SYNC2_BYPASS Configures whether or not to synchronize GPIO input data on either edge of IO MUX operating clock for the second-level synchronization.

- 0: Not synchronize
 - 1: Synchronize on falling edge
 - 2: Synchronize on rising edge
 - 3: Synchronize on rising edge
- (R/W)

GPIO_PIN n _PAD_DRIVER Configures to select pin drive mode.

- 0: Normal output
 - 1: Open drain output
- (R/W)

GPIO_PIN n _SYNC1_BYPASS Configures whether or not to synchronize GPIO input data on either edge of IO MUX operating clock for the first-level synchronization.

- 0: Not synchronize
 - 1: Synchronize on falling edge
 - 2: Synchronize on rising edge
 - 3: Synchronize on rising edge
- (R/W)

GPIO_PIN n _INT_TYPE Configures GPIO interrupt type.

- 0: GPIO interrupt disabled
 - 1: Rising edge trigger
 - 2: Falling edge trigger
 - 3: Any edge trigger
 - 4: Low level trigger
 - 5: High level trigger
- (R/W)

GPIO_PIN n _WAKEUP_ENABLE Configures whether or not to enable GPIO wake-up function.

- 0: Disable
 - 1: Enable
- This function only wakes up the CPU from Light-sleep.
- (R/W)

Continued on the next page...

Register 7.14. GPIO_PIN n _REG (n : 0-30) (0x0074+4* n)

Continued from the previous page...

GPIO_PIN n _INT_ENA Configures whether or not to enable CPU interrupt or CPU non-maskable interrupt.

- bit13: Configures whether or not to enable CPU interrupt:
0: Disable
1: Enable
- bit14: Configures CPU non-maskable interrupt:
0: Disable
1: Enable
- bit15 ~ bit17: invalid

(R/W)

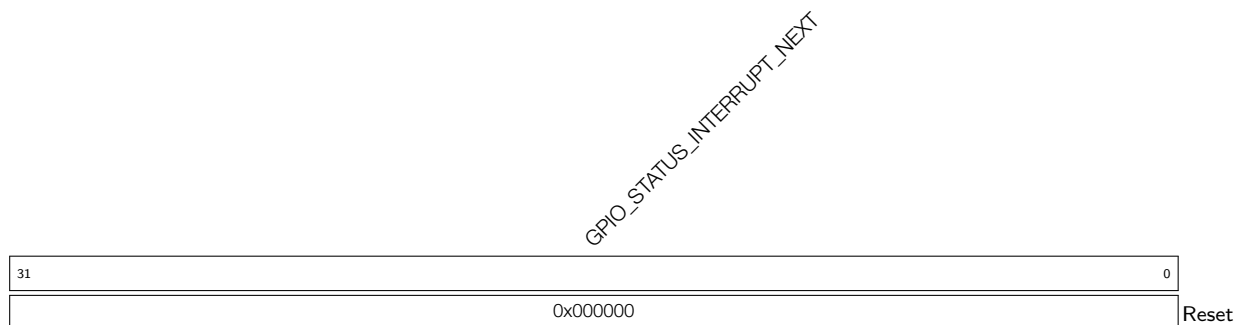
Register 7.15. GPIO_STATUS_NEXT_REG (0x014C)**GPIO_STATUS_INTERRUPT_NEXT** Represents the interrupt source signal of GPIO0 ~ GPIO30.

Bit0 ~ bit30 are corresponding to GPIO0 ~ 30. Bit31 is invalid. Each bit represents:

0: The GPIO does not generate the interrupt configured by **GPIO_PIN n _INT_TYPE**.1: The GPIO generates an interrupt configured by **GPIO_PIN n _INT_TYPE**.

The interrupt could be rising edge interrupt, falling edge interrupt, level sensitive interrupt and any edge interrupt.

(RO)

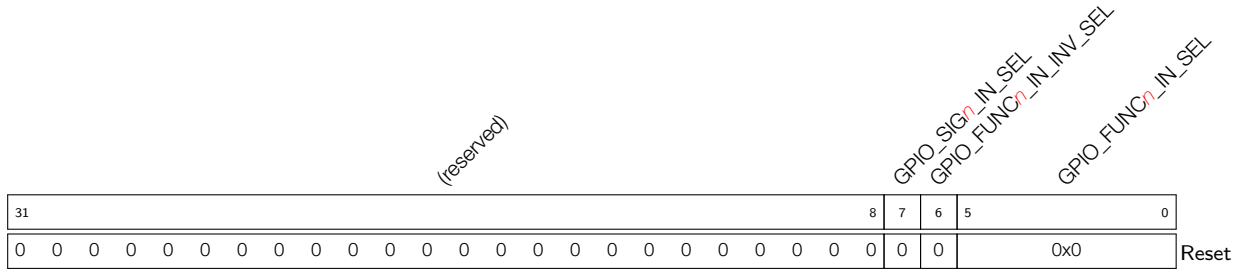
Register 7.16. GPIO_FUNC n _IN_SEL_CFG_REG (n : 0-127) (0x0154+4* n)

GPIO_FUNC n _IN_SEL Configures to select a pin from the 31 GPIO pins to connect the input signal

n .

0: Select GPIO0

1: Select GPIO1

.....

29: Select GPIO29

30: Select GPIO30

Or

0x38: A constantly high input

0x3C: A constantly low input

(R/W)

GPIO_FUNC n _IN_INV_SEL Configures whether or not to invert the input value.

0: Not invert

1: Invert

(R/W)

GPIO_SIG n _IN_SEL Configures whether or not to route signals via GPIO matrix.

0: Bypass GPIO matrix, i.e., connect signals directly to peripheral configured in IO MUX.

1: Route signals via GPIO matrix.

(R/W)

Register 7.17. GPIO_FUNC n _OUT_SEL_CFG_REG (n : 0-30) (0x0554+4* n)

(reserved)											GPIO_FUNC n _OEN_INV_SEL			GPIO_FUNC n _OEN_SEL			GPIO_FUNC n _OUT_INV_SEL			GPIO_FUNC n _OUT_SEL		
31											11	10	9	8	7							0
0 0											0	0	0	0	0	0x80						Reset

GPIO_FUNC n _OUT_SEL Configures to select a signal Y ($0 \leq Y < 128$) from 128 peripheral signals to be output from GPIO n .

0: Select signal 0

1: Select signal 1

.....

126: Select signal 126

127: Select signal 127

Or

128: Bit n of [GPIO_OUT_REG](#) and [GPIO_ENABLE_REG](#) are selected as the output value and output enable.

For the detailed signal list, see [Table 7-2](#).

(R/W/SC)

GPIO_FUNC n _OUT_INV_SEL Configures whether or not to invert the output value.

0: Not invert

1: Invert

(R/W/SC)

GPIO_FUNC n _OEN_SEL Configures to select the source of output enable signal.

0: Use output enable signal from peripheral.

1: Force the output enable signal to be sourced from bit n of [GPIO_ENABLE_REG](#).

(R/W)

GPIO_FUNC n _OEN_INV_SEL Configures whether or not to invert the output enable signal.

0: Not invert

1: Invert

(R/W)

Register 7.18. GPIO_CLOCK_GATE_REG (0x062C)

(reserved)																GPIO_CLK_EN																
31																															1	0
0 0																														1	0	

Reset

GPIO_CLK_EN Configures whether or not to enable clock gate.

0: Not enable

1: Enable, the clock is free running.

(R/W)

Register 7.19. GPIO_DATE_REG (0x06FC)

(reserved)				GPIO_DATE																												
31	28	27																													0	
0 0 0 0				0x1907040																												

Reset

GPIO_DATE Version control register.

(R/W)

7.16.2 IO MUX Registers

The addresses in this section are relative to the IO MUX base address provided in Table 5-2 in Chapter 5 *System and Memory*.

Register 7.20. IO_MUX_PIN_CTRL_REG (0x0000)

(reserved)																IO_MUX_CLK_OUT3				IO_MUX_CLK_OUT2				IO_MUX_CLK_OUT1					
31															15	14					10	9					5	4	0
0 0 0 0 0 0 0 0 0 0 0 0 0 0 0 0																0x7				0xf				0xf					

Reset

IO_MUX_CLK_OUT_x (x: 1 - 3) Configures the output clock for I2S.

0x0: Select CLK_OUT_out_x for I2S output clock.

CLK_OUT_out_x can be found in Table 7-2.

(R/W)

Register 7.21. IO_MUX_GPIO n _REG (n : 0-30) (0x0004+4* n)

(reserved)	IO_MUX_GPIO n _FILTER_EN	IO_MUX_GPIO n _MCU_SEL	IO_MUX_GPIO n _FUN_DRV	IO_MUX_GPIO n _FUN_IE	IO_MUX_GPIO n _FUN_WPU	IO_MUX_GPIO n _FUN_WPD	IO_MUX_GPIO n _MCU_DRV	IO_MUX_GPIO n _MCU_IE	IO_MUX_GPIO n _MCU_WPU	IO_MUX_GPIO n _MCU_WPD	IO_MUX_GPIO n _SLP_SEL	IO_MUX_GPIO n _MCU_OE					
31	16	15	14	12	11	10	9	8	7	6	5	4	3	2	1	0	
0	0	0	0	0	0	0	0	0	0	0	0	0	0	0	0	0	Reset

IO_MUX_GPIO n _MCU_OE Configures whether or not to enable the output of GPIO n in sleep mode.

0: Disable

1: Enable

(R/W)

IO_MUX_GPIO n _SLP_SEL Configures whether or not to enter sleep mode for GPIO n .

0: Not enter

1: Enter

(R/W)

IO_MUX_GPIO n _MCU_WPD Configure whether or not to enable pull-down resistor of GPIO n in sleep mode.

0: Disable

1: Enable

(R/W)

IO_MUX_GPIO n _MCU_WPU Configures whether or not to enable pull-up resistor of GPIO n during sleep mode.

0: Disable

1: Enable

(R/W)

IO_MUX_GPIO n _MCU_IE Configures whether or not to enable the input of GPIO n during sleep mode.

0: Disable

1: Enable

(R/W)

IO_MUX_GPIO n _MCU_DRV Configures the drive strength of GPIO n during sleep mode.

0: ~5 mA

1: ~10 mA

2: ~20 mA

3: ~40 mA

(R/W)

IO_MUX_GPIO n _FUN_WPD Configures whether or not to enable pull-down resistor of GPIO n .

0: Disable

1: Enable

(R/W)

Continued on the next page...

Register 7.21. IO_MUX_GPIO n _REG (n : 0-30) (0x0004+4* n)

Continued from the previous page...

IO_MUX_GPIO n _FUN_WPU Configures whether or not enable pull-up resistor of GPIO n .

0: Disable

1: Enable

(R/W)

IO_MUX_GPIO n _FUN_IE Configures whether or not to enable input of GPIO n .

0: Disable

1: Enable

(R/W)

IO_MUX_GPIO n _FUN_DRV Configures the drive strength of GPIO n .

0: ~5 mA

1: ~10 mA

2: ~20 mA

3: ~40 mA

(R/W)

IO_MUX_GPIO n _MCU_SEL Configures to select IO MUX function for this signal.

0: Select Function 0

1: Select Function 1

.....

(R/W)

IO_MUX_GPIO n _FILTER_EN Configures whether or not to enable filter for pin input signals.

0: Disable

1: Enable

(R/W)

Register 7.22. IO_MUX_DATE_REG (0x00FC)

31	28	27	0
(reserved)		IO_MUX_DATE_REG	
0	0	0	0
0x2006050			Reset

IO_MUX_DATE_REG Version control register.

(R/W)

7.16.3 Sub Design Registers

The addresses in this section are relative to (GPIO base address + 0x0F00). GPIO base address is provided in Table 5-2 in Chapter 5 *System and Memory*.

Register 7.23. GPIOSD_SIGMADELTA_n_REG (n: 0-3) (0x0000+0x4*n)

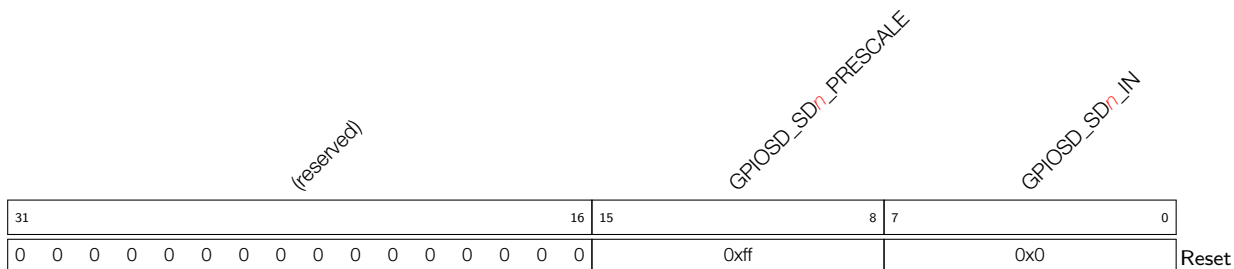

GPIOSD_SD_n_IN (n: 0 - 3) Configures the duty cycle of sigma delta modulation output.
(R/W)

GPIOSD_SD_n_PRESCALE (n: 0 - 3) Configures the divider value to divide IO MUX operating clock.
(R/W)

Register 7.24. GPIOSD_SIGMADELTA_MISC_REG (0x0024)

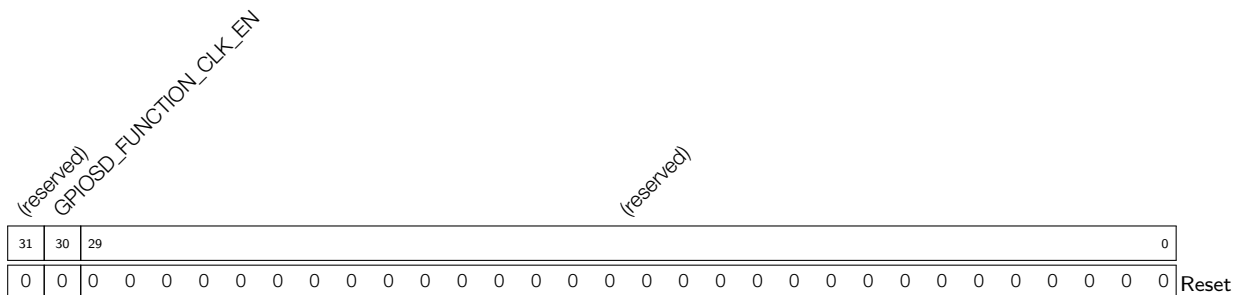

GPIOSD_FUNCTION_CLK_EN Configures whether or not to enable the clock for sigma delta modulation.
0: Not enable
1: Enable
(R/W)

Register 7.25. GPIOSD_GLITCH_FILTER_CH n _REG (n : 0-7) (0x0030+0x4* n)

(reserved)										GPIOSD_FILTER_CH n _WINDOW_WIDTH				GPIOSD_FILTER_CH n _WINDOW_THRES				GPIOSD_FILTER_CH n _INPUT_IO_NUM				GPIOSD_FILTER_CH n _EN								
31											19	18					13	12					7	6					1	0
0 0 0 0 0 0 0 0 0 0										0x0				0x0				0x0				0				Reset				

GPIOSD_FILTER_CH n _EN Configures whether or not to enable channel n of Glitch Filter.

0: Not enable

1: Enable

(R/W)

GPIOSD_FILTER_CH n _INPUT_IO_NUM Configures to select the input GPIO for Glitch Filter.

0: Select GPIO0

1: Select GPIO1

.....

29: Select GPIO29

30: Select GPIO30

(R/W)

GPIOSD_FILTER_CH n _WINDOW_THRES Configures the window threshold for Glitch Filter. The window threshold should be less than or equal to [GPIOSD_FILTER_CH \$n\$ _WINDOW_WIDTH](#).

Measurement unit: IO MUX operating clock cycle

(R/W)

GPIOSD_FILTER_CH n _WINDOW_WIDTH Configures the window width for Glitch Filter. The effective value of window width is 0 ~ 62. 63 is a reserved value and cannot be used.

Measurement unit: IO MUX operating clock cycle

(R/W)

Register 7.26. GPIOSD_ETM_EVENT_CH n _CFG_REG (n : 0-7) (0x0060+0x4*n)

(reserved)																GPIOSD_ETM_CH n _EVENT_EN			GPIOSD_ETM_CH n _EVENT_SEL					
31																8	7	6	5	4				0
0																0	0	0	0x0			Reset		

GPIOSD_ETM_CH n _EVENT_SEL Configures to select GPIO for ETM event channel.

0: Select GPIO0

1: Select GPIO1

.....

29: Select GPIO29

30: Select GPIO30

(R/W)

GPIOSD_ETM_CH n _EVENT_EN Configures whether or not to enable ETM event send.

0: Not enable

1: Enable

(R/W)

Register 7.27. GPIOSD_ETM_TASK_P0_CFG_REG (0x00A0)

(reserved)				GPIOSD_ETM_TASK_GPIO3_SEL				GPIOSD_ETM_TASK_GPIO3_EN				(reserved)				GPIOSD_ETM_TASK_GPIO2_SEL				GPIOSD_ETM_TASK_GPIO2_EN				(reserved)				GPIOSD_ETM_TASK_GPIO1_SEL				GPIOSD_ETM_TASK_GPIO1_EN				(reserved)				GPIOSD_ETM_TASK_GPIO0_SEL				GPIOSD_ETM_TASK_GPIO0_EN			
31				28	27			25	24	23				20	19			17	16	15				12	11			9	8	7				4	3			1	0								
0				0				0x0				0				0x0				0				0x0				0				0x0				0				Reset							

GPIOSD_ETM_TASK_GPIO n _EN (n : 0 - 3) Configures whether or not to enable GPIO n to response ETM task.

0: Not enable

1: Enable

(R/W)

GPIOSD_ETM_TASK_GPIO n _SEL (n : 0 - 3) Configures to select an ETM task channel for GPIO n .

0: Select channel 0

1: Select channel 1

.....

7: Select channel 7

(R/W)

Register 7.28. GPIOSD_ETM_TASK_P1_CFG_REG (0x00A4)

(reserved)				GPIOSD_ETM_TASK_GPIO7_SEL				GPIOSD_ETM_TASK_GPIO7_EN				(reserved)				GPIOSD_ETM_TASK_GPIO6_SEL				GPIOSD_ETM_TASK_GPIO6_EN				(reserved)				GPIOSD_ETM_TASK_GPIO5_SEL				GPIOSD_ETM_TASK_GPIO5_EN				(reserved)				GPIOSD_ETM_TASK_GPIO4_SEL				GPIOSD_ETM_TASK_GPIO4_EN			
31	28	27	25	24	23	20	19	17	16	15	12	11	9	8	7	4	3	1	0	31	28	27	25	24	23	20	19	17	16	15	12	11	9	8	7	4	3	1	0								
0	0	0	0	0	0x0	0	0	0	0	0	0	0	0	0	0	0x0	0	0	0	0	0	0	0	0	0	0	0	0	0	0	0	0	0	0	0	0	0	0	0	0	Reset						

GPIOSD_ETM_TASK_GPIO n _EN (n : 4 - 7) Configures whether or not to enable GPIO n to response ETM task.

0: Not enable

1: Enable

(R/W)

GPIOSD_ETM_TASK_GPIO n _SEL (n : 4 - 7) Configures to select an ETM task channel for GPIO n .

0: Select channel 0

1: Select channel 1

.....

7: Select channel 7

(R/W)

Register 7.29. GPIOSD_ETM_TASK_P2_CFG_REG (0x00A8)

(reserved)				GPIOSD_ETM_TASK_GPIO11_SEL				GPIOSD_ETM_TASK_GPIO11_EN				(reserved)				GPIOSD_ETM_TASK_GPIO10_SEL				GPIOSD_ETM_TASK_GPIO10_EN				(reserved)				GPIOSD_ETM_TASK_GPIO9_SEL				GPIOSD_ETM_TASK_GPIO9_EN				(reserved)				GPIOSD_ETM_TASK_GPIO8_SEL				GPIOSD_ETM_TASK_GPIO8_EN			
31	28	27	25	24	23	20	19	17	16	15	12	11	9	8	7	4	3	1	0	31	28	27	25	24	23	20	19	17	16	15	12	11	9	8	7	4	3	1	0								
0	0	0	0	0	0x0	0	0	0	0	0	0	0	0	0	0	0x0	0	0	0	0	0	0	0	0	0	0	0	0	0	0	0	0x0	0	0	0	0	0	0	0								

Reset

GPIOSD_ETM_TASK_GPIO n _EN (n : 8 - 11) Configures whether or not to enable GPIO n to response ETM task.

0: Not enable

1: Enable

(R/W)

GPIOSD_ETM_TASK_GPIO n _SEL (n : 8 - 11) Configures to select an ETM task channel for GPIO n .

0: Select channel 0

1: Select channel 1

.....

7: Select channel 7

(R/W)

Register 7.30. GPIOSD_ETM_TASK_P3_CFG_REG (0x00AC)

(reserved)				GPIOSD_ETM_TASK_GPIO15_SEL				GPIOSD_ETM_TASK_GPIO15_EN				(reserved)				GPIOSD_ETM_TASK_GPIO14_SEL				GPIOSD_ETM_TASK_GPIO14_EN				(reserved)				GPIOSD_ETM_TASK_GPIO13_SEL				GPIOSD_ETM_TASK_GPIO13_EN				(reserved)				GPIOSD_ETM_TASK_GPIO12_SEL				GPIOSD_ETM_TASK_GPIO12_EN			
31	28	27	25	24	23	20	19	17	16	15	12	11	9	8	7	4	3	1	0	Reset																											
0	0	0	0	0	0x0	0	0	0	0	0	0	0	0	0	0	0	0x0	0	0	0	0	0	0	0	0	0	0	0	0	0x0	0																

GPIOSD_ETM_TASK_GPIO n _EN (n : 12 - 15) Configures whether or not to enable GPIO n to response ETM task.

0: Not enable

1: Enable

(R/W)

GPIOSD_ETM_TASK_GPIO n _SEL (n : 12 - 15) Configures to select an ETM task channel for GPIO n .

0: Select channel 0

1: Select channel 1

.....

7: Select channel 7

(R/W)

Register 7.31. GPIOSD_ETM_TASK_P4_CFG_REG (0x00B0)

(reserved)				GPIOSD_ETM_TASK_GPIO19_SEL				(reserved)				GPIOSD_ETM_TASK_GPIO18_SEL				(reserved)				GPIOSD_ETM_TASK_GPIO17_SEL				(reserved)				GPIOSD_ETM_TASK_GPIO16_SEL									
31	28	27	25	24	23	20	19	17	16	15	12	11	9	8	7	4	3	1	0																		
0	0	0	0	0	0x0	0	0	0	0	0	0x0	0	0	0	0	0	0x0	0	0																		
																			0	0	0	0	0	0	0	0	0	0	0	0	0	0	0	0	0	0	0
																			Reset																		

GPIOSD_ETM_TASK_GPIO n _EN (n : 16 - 19) Configures whether or not to enable GPIO n to response ETM task.

0: Not enable

1: Enable

(R/W)

GPIOSD_ETM_TASK_GPIO n _SEL (n : 16 - 19) Configures to select an ETM task channel for GPIO n .

0: Select channel 0

1: Select channel 1

.....

7: Select channel 7

(R/W)

Register 7.32. GPIOSD_ETM_TASK_P5_CFG_REG (0x00B4)

(reserved)				GPIOSD_ETM_TASK_GPIO23_SEL				GPIOSD_ETM_TASK_GPIO23_EN				(reserved)				GPIOSD_ETM_TASK_GPIO22_SEL				GPIOSD_ETM_TASK_GPIO22_EN				(reserved)				GPIOSD_ETM_TASK_GPIO21_SEL				GPIOSD_ETM_TASK_GPIO21_EN				(reserved)				GPIOSD_ETM_TASK_GPIO20_SEL				GPIOSD_ETM_TASK_GPIO20_EN			
31	28	27	25	24	23	20	19	17	16	15	12	11	9	8	7	4	3	1	0																												
0	0	0	0	0	0x0	0	0	0	0	0	0	0	0	0	0	0	0	0	0																												
																			0	0	0	0	0	0	0	0	0	0	0	0	0	0	0	0	0	0	0										
																			Reset																												

GPIOSD_ETM_TASK_GPIO n _EN (n : 20 - 23) Configures whether or not to enable GPIO n to response ETM task.

0: Not enable

1: Enable

(R/W)

GPIOSD_ETM_TASK_GPIO n _SEL (n : 20 - 23) Configures to select an ETM task channel for GPIO n .

0: Select channel 0

1: Select channel 1

.....

7: Select channel 7

(R/W)

Register 7.33. GPIOSD_ETM_TASK_P6_CFG_REG (0x00B8)

(reserved)				GPIOSD_ETM_TASK_GPIO27_SEL				GPIOSD_ETM_TASK_GPIO27_EN				(reserved)				GPIOSD_ETM_TASK_GPIO26_SEL				GPIOSD_ETM_TASK_GPIO26_EN				(reserved)				GPIOSD_ETM_TASK_GPIO25_SEL				GPIOSD_ETM_TASK_GPIO25_EN				(reserved)				GPIOSD_ETM_TASK_GPIO24_SEL				GPIOSD_ETM_TASK_GPIO24_EN			
31	28	27	25	24	23	20	19	17	16	15	12	11	9	8	7	4	3	1	0	0	0	0	0	0x0	0	0	0	0	0	0x0	0	0	0	0	0	0	0	0x0	0	Reset							

GPIOSD_ETM_TASK_GPIO n _EN (n : 24 - 27) Configures whether or not to enable GPIO n to response ETM task.

0: Not enable

1: Enable

(R/W)

GPIOSD_ETM_TASK_GPIO n _SEL (n : 24 - 27) Configures to select an ETM task channel for GPIO n .

0: Select channel 0

1: Select channel 1

.....

7: Select channel 7

(R/W)

Register 7.34. GPIOSD_ETM_TASK_P7_CFG_REG (0x00BC)

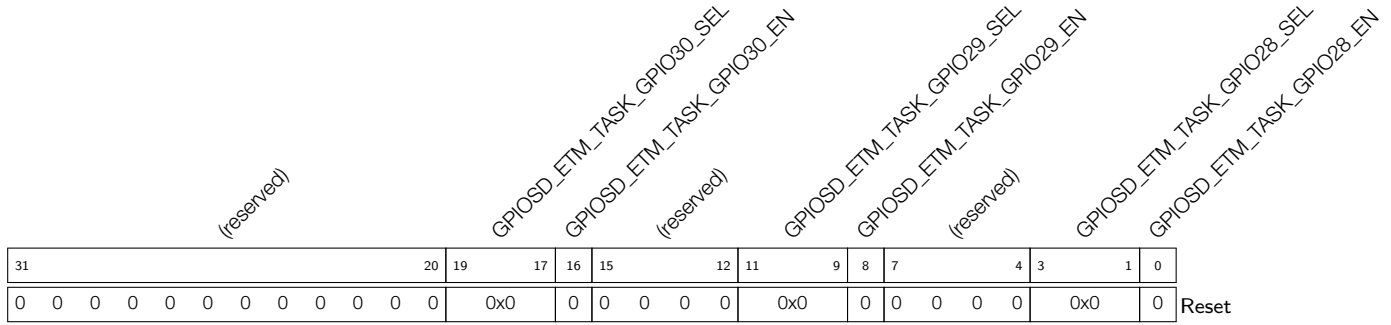

GPIOSD_ETM_TASK_GPIO n _EN (n : 28 - 30) Configures whether or not to enable GPIO n to response ETM task.
 0: Not enable
 1: Enable
 (R/W)

GPIOSD_ETM_TASK_GPIO n _SEL (n : 28 - 30) Configures to select an ETM task channel for GPIO n .
 0: Select channel 0
 1: Select channel 1

 7: Select channel 7
 (R/W)

Register 7.35. GPIOSD_VERSION_REG (0x00FC)



GPIOSD_GPIO_SD_DATE Version control register.
 (R/W)

7.16.4 LP IO MUX Registers

The addresses in this section are relative to LP_IO base address provided in Table 5-2 in Chapter 5 System and Memory.

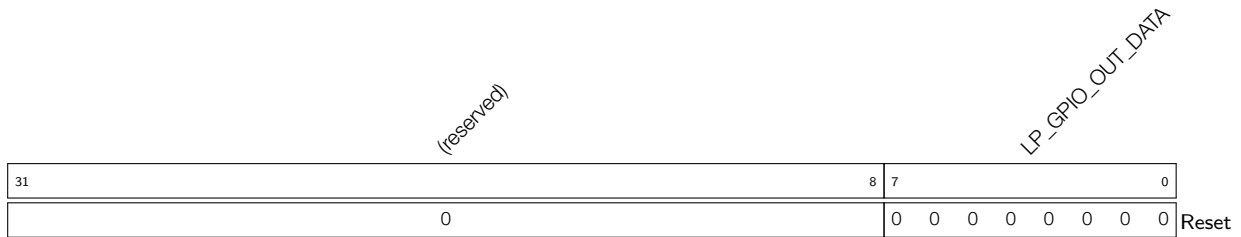
Register 7.36. LP_IO_OUT_REG (0x0000)

LP_GPIO_OUT_DATA Configures the output of GPIO0 ~ GPIO7.

0: Low level

1: High level

bit0 ~ bit7 are corresponding to GPIO0 ~ GPIO7.

(R/W)

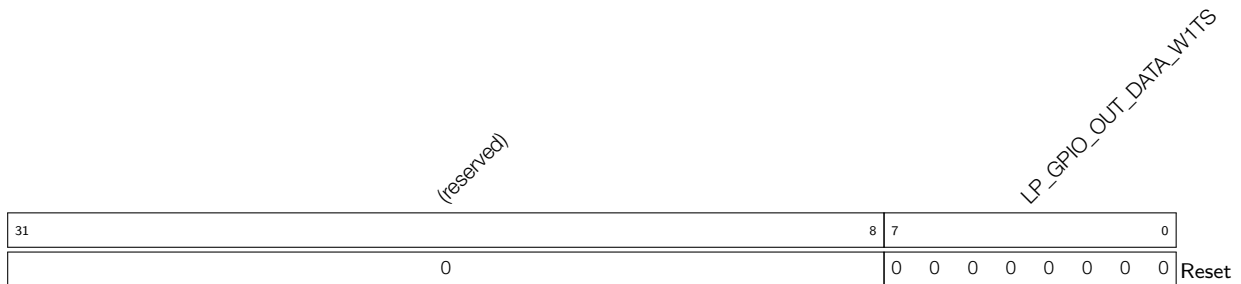
Register 7.37. LP_IO_OUT_W1TS_REG (0x0004)

LP_GPIO_OUT_DATA_W1TS Configures whether or not to enable the output register [LP_IO_OUT_REG](#) of GPIO0 ~ GPIO7.

- bit0 ~ bit7 are corresponding to GPIO0 ~ GPIO7.
- If the value 1 is written to a bit here, the corresponding bit in [LP_IO_OUT_REG](#) will be set to 1.
- Recommended operation: use this register to set [LP_IO_OUT_REG](#).

(WT)

Register 7.38. LP_IO_OUT_W1TC_REG (0x0008)

(reserved)								LP_GPIO_OUT_DATA_W1TC									
31								8	7								0
0								0 0 0 0 0 0 0 0								Reset	

LP_GPIO_OUT_DATA_W1TC Configures whether or not to clear the output register [LP_IO_OUT_REG](#) of GPIO0 ~ GPIO7.

- bit0 ~ bit7 are corresponding to GPIO0 ~ GPIO7.
- If the value 1 is written to a bit here, the corresponding bit in [LP_IO_OUT_REG](#) will be cleared.
- Recommended operation: use this register to clear [LP_IO_OUT_REG](#).

(WT)

Register 7.39. LP_IO_ENABLE_REG (0x000C)

(reserved)								LP_GPIO_ENABLE									
31								8	7								0
0								0 0 0 0 0 0 0 0								Reset	

LP_GPIO_ENABLE Configures whether or not to enable the output of GPIO0 ~ GPIO7.

0: Not enable

1: Enable

bit0 ~ bit7 are corresponding to GPIO0 ~ GPIO7.

(R/W)

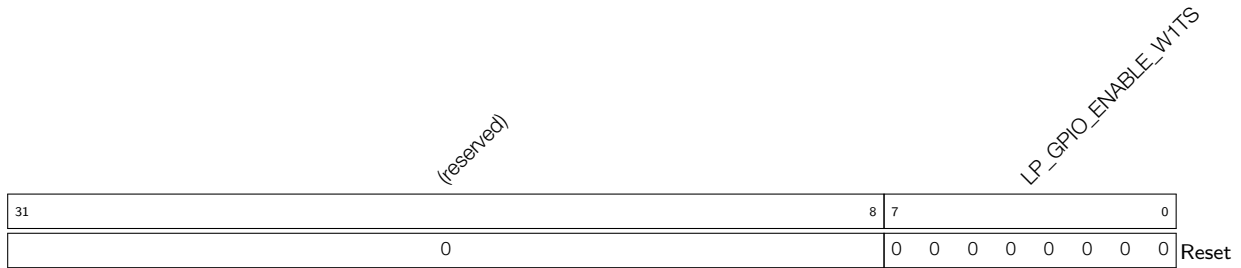
Register 7.40. LP_IO_ENABLE_W1TS_REG (0x0010)

LP_GPIO_ENABLE_W1TS Configures whether or not to set the output enable register [LP_IO_ENABLE_REG](#) of GPIO0 ~ GPIO7.

- bit0 ~ bit7 are corresponding to GPIO0 ~ GPIO7.
- If the value 1 is written to a bit here, the corresponding bit in [LP_IO_ENABLE_REG](#) will be set to 1.
- Recommended operation: use this register to set [LP_IO_ENABLE_REG](#).

(WT)

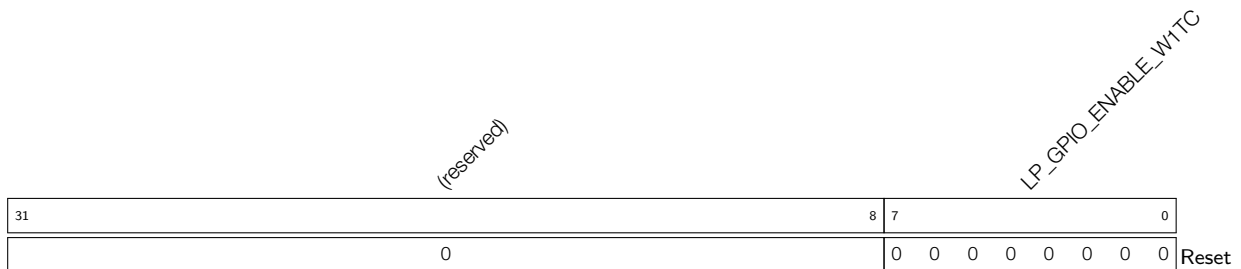
Register 7.41. LP_IO_ENABLE_W1TC_REG (0x0014)

LP_GPIO_ENABLE_W1TC Configures whether or not to clear the output enable register [LP_IO_ENABLE_REG](#) of GPIO0 ~ GPIO7.

- bit0 ~ bit7 are corresponding to GPIO0 ~ GPIO7.
- If the value 1 is written to a bit here, the corresponding bit in [LP_IO_ENABLE_REG](#) will be cleared.
- Recommended operation: use this register to clear [LP_IO_ENABLE_REG](#).

(WT)

Register 7.42. LP_IO_STATUS_REG (0x0018)

31	(reserved)	8	7	0	
0			0 0 0 0 0 0 0 0		Reset

LP_GPIO_STATUS_INT Configures the interrupt status of GPIO0 ~ GPIO7.

0: No interrupt

1: Interrupt is triggered

Bit0 is corresponding to GPIO0, bit1 is corresponding to GPIO1, and etc. This register is used together [LP_IO_PIN \$n\$ _INT_TYPE](#) in register [LP_IO_PIN \$n\$ _REG](#).

(R/W)

Register 7.43. LP_IO_STATUS_W1TS_REG (0x001C)

31	(reserved)	8	7	0	
0			0 0 0 0 0 0 0 0		Reset

LP_GPIO_STATUS_INT_W1TS Configures whether or not to set the interrupt status register [LP_IO_STATUS_INT](#) of GPIO0 ~ GPIO7.

- Bit0 is corresponding to GPIO0, bit1 is corresponding to GPIO1, and etc.
- If the value 1 is written to a bit here, the corresponding bit in [LP_IO_STATUS_INT](#) will be set to 1.
- Recommended operation: use this register to set [LP_IO_STATUS_INT](#).

(WT)

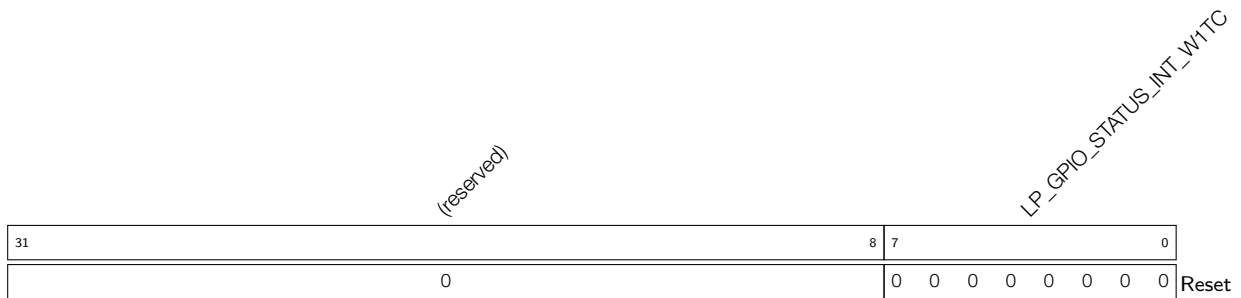
Register 7.44. LP_IO_STATUS_W1TC_REG (0x0020)

LP_GPIO_STATUS_INT_W1TC Configures whether or not to clear the interrupt status register [LP_IO_STATUS_INT](#) of GPIO0 ~ GPIO7.

- Bit0 is corresponding to GPIO0, bit1 is corresponding to GPIO1, and etc.
- If the value 1 is written to a bit here, the corresponding bit in [LP_IO_STATUS_INT](#) will be cleared
- ecommended operation: use this register to clear [LP_IO_STATUS_INT](#).

(WT)

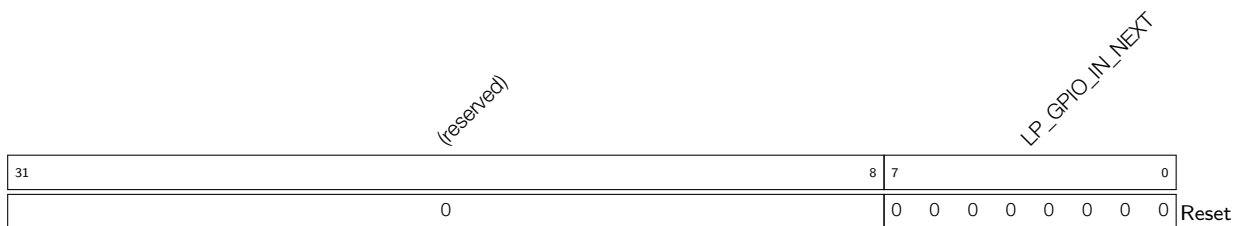
Register 7.45. LP_IO_IN_REG (0x0024)

LP_GPIO_IN_NEXT Represents the input value of GPIO0 ~ GPIO7.

0: Low level input

1: High level input

bit0 ~ bit7 are corresponding to GPIO0 ~ GPIO7.

(RO)

Register 7.46. LP_IO_PIN n _REG (n : 0-7) (0x0028+0x4*n)

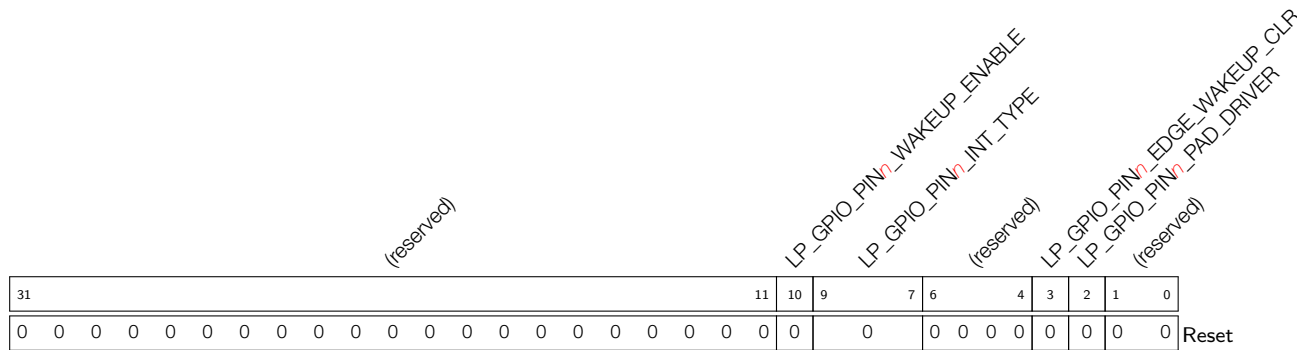

LP_GPIO_PIN n _PAD_DRIVER Configures to select the pin drive mode of GPIO n .

- 0: Normal output
 - 1: Open drain output
- (R/W)

LP_GPIO_PIN n _EDGE_WAKEUP_CLR Configures whether or not to clear the edge wake-up status of GPIO0 ~ GPIO7.

- bit0 ~ bit7 are corresponding to GPIO0 ~ GPIO7.
- If the value 1 is written to a bit here, the edge wake-up status of corresponding GPIO will be cleared.

(WT)

LP_GPIO_PIN n _INT_TYPE Configures GPIO n interrupt type.

- 0: GPIO interrupt disabled
 - 1: Rising edge trigger
 - 2: Falling edge trigger
 - 3: Any edge trigger
 - 4: Low level trigger
 - 5: High level trigger
- (R/W)

LP_GPIO_PIN n _WAKEUP_ENABLE Configures whether or not to enable GPIO n wake-up function.

- 0: Not enable
 - 1: Enable
- This function is disabled when PD_LP_PERI is powered off.
- (R/W)

Register 7.47. LP_IO_GPIO n _REG (n : 0-7) (0x0048+0x4* n)

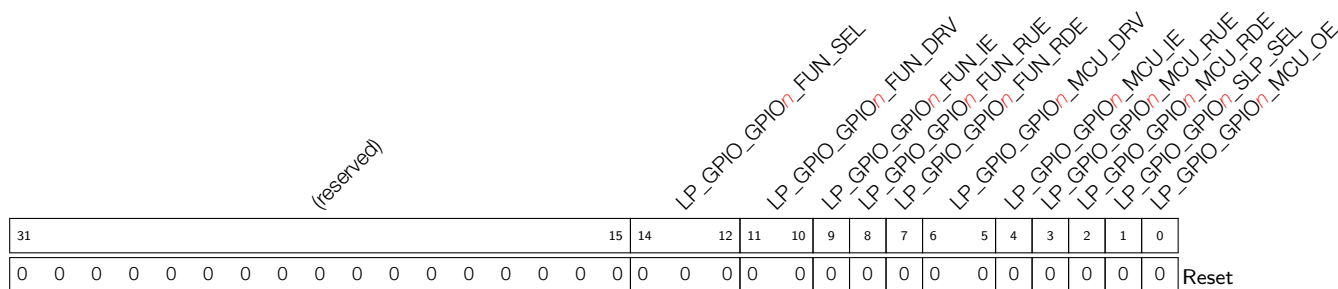

LP_GPIO_GPIO n _FUN_SEL Configures to select the LP IO MUX function for GPIO n in normal execution mode.

- 0: Select Function 0
- 1: Select Function 1

.....
(R/W)

LP_GPIO_GPIO n _FUN_DRV Configures the drive strength of GPIO n in normal execution mode.

- 0: ~5 mA
- 1: ~10 mA
- 2: ~20 mA
- 3: ~40 mA

(R/W)

LP_GPIO_GPIO n _FUN_IE Configures whether or not to enable the input of GPIO n in normal execution mode.

- 0: Not enable
- 1: Enable

(R/W)

LP_GPIO_GPIO n _FUN_RUE Configures whether or not to enable the pull-up resistor of GPIO n in normal execution mode.

- 0: Not enable
- 1: Enable

(R/W)

LP_GPIO_GPIO n _FUN_RDE Configures whether or not to enable the pull-down resistor of GPIO n in normal execution mode.

- 0: Not enable
- 1: Enable

(R/W)

LP_GPIO_GPIO n _MCU_DRV Configures the drive strength of GPIO n during sleep mode.

- 0: ~5 mA
- 1: ~10 mA
- 2: ~20 mA
- 3: ~40 mA

(R/W)

Continued on the next page...

Register 7.47. LP_IO_GPIO n _REG (n : 0-7) (0x0048+0x4* n)

Continued from the previous page...

LP_GPIO_GPIO n _MCU_IE Configures whether or not to enable the input of GPIO n during sleep mode.

0: Not enable

1: Enable

(R/W)

LP_GPIO_GPIO n _MCU_RUE Configures whether or not to enable the pull-up resistor of GPIO n during sleep mode.

0: Not enable

1: Enable

(R/W)

LP_GPIO_GPIO n _MCU_RDE Configures whether or not to enable the pull-down resistor of GPIO n during sleep mode.

0: Not enable

1: Enable

(R/W)

LP_GPIO_GPIO n _SLP_SEL Configures whether or not to enable the sleep mode for GPIO n .

0: Not enable

1: Enable

(R/W)

LP_GPIO_GPIO n _MCU_OE Configures whether or not to enable the output of GPIO n during sleep mode.

0: Not enable

1: Enable

(R/W)

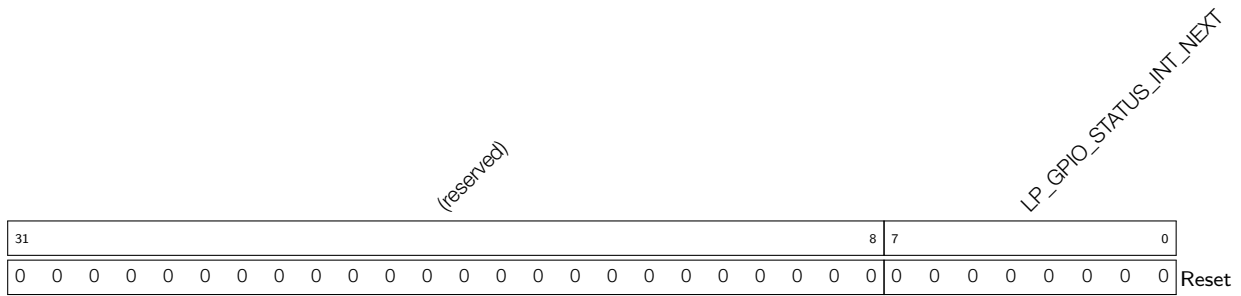
Register 7.48. LP_IO_STATUS_INT_REG (0x0068)

LP_GPIO_STATUS_INT_NEXT Represents the interrupt source status of GPIO0 ~ GPIO7.

bit0 ~ bit7 are corresponding to GPIO0 ~ 7. Each bit represents:

0: Interrupt source status is invalid.

1: Interrupt source status is valid.

The interrupt here can be rising-edge triggered, falling-edge triggered, any edge triggered, or level triggered.

(RO)

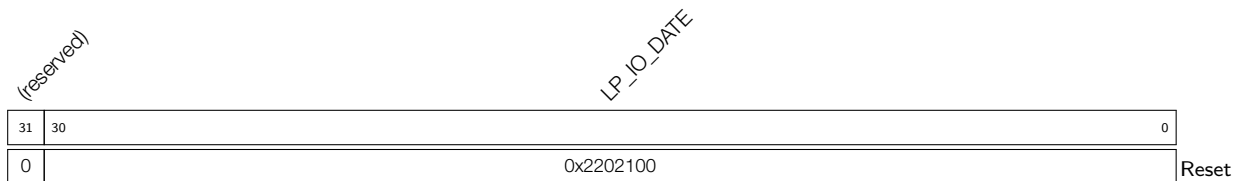
Register 7.49. LP_IO_DATE_REG (0x03FC)

LP_IO_DATE Version control register.

(R/W)

8 Reset and Clock

8.1 Reset

8.1.1 Overview

ESP32-C6 provides four types of reset that occur at different levels, namely CPU Reset, Core Reset, System Reset, and Chip Reset. All reset types mentioned above (except Chip Reset) preserve the data stored in internal memory. Figure 8-1 shows the scopes of affected subsystems by each type of reset.

8.1.2 Architectural Overview

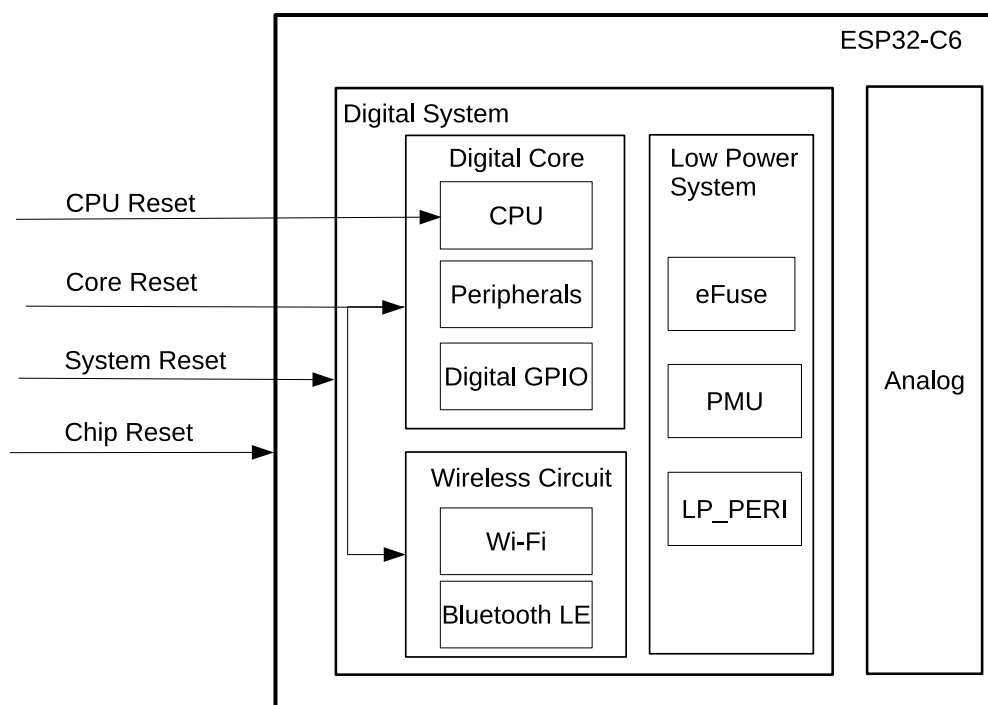

Figure 8-1. Reset Types

ESP32-C6's Digital System consists of [High Performance System \(HP system\)](#) that includes Digital Core and Wireless Circuit, and [Low Power System \(LP system\)](#). See Figure 8-1 for details.

8.1.3 Features

- Four reset types:
 - CPU Reset: resets CPU core. Once such reset is released, the instructions from the CPU reset vector will be executed.
 - Core Reset: resets the whole digital system except LP system, including CPU, peripherals, Wi-Fi, Bluetooth[®] LE, and digital GPIOs.
 - System Reset: resets the whole digital system, including LP system.
 - Chip Reset: resets the whole chip.
- Software reset and hardware reset:

- Software Reset: triggered via software by configuring the corresponding registers of CPU, see Chapter 2 *Low-Power Management [to be added later]*.
- Hardware Reset: triggered directly by the hardware.

8.1.4 Functional Description

CPU will be reset immediately when any type of reset above occurs. Users can retrieve reset source codes by reading `LP_CLKRST_RESET_CAUSE` after the reset is released. Table 8-1 lists possible reset sources and the types of reset they trigger.

Table 8-1. Reset Source

Code	Source	Reset Type	Note
0x01	Chip reset ¹	Chip Reset	—
0x0F	Brown-out system reset	Chip Reset or System Reset	Triggered by brown-out detector ²
0x10	RWDT system reset	System Reset	See Chapter 14 <i>Watchdog Timers (WDT)</i>
0x12	Super Watchdog reset	System Reset	See Chapter 14 <i>Watchdog Timers (WDT)</i>
0x03	Software system reset	Core Reset	Triggered by configuring <code>LP_AON_HPSYS_SW_RESET</code>
0x05	Deep-sleep reset	Core Reset	See Chapter 2 <i>Low-Power Management [to be added later]</i>
0x06	SDIO core reset	Core Reset	See Chapter 33 <i>SDIO 2.0 Slave Controller (SDIO)</i>
0x07	MWDT0 core reset	Core Reset	See Chapter 14 <i>Watchdog Timers (WDT)</i>
0x08	MWDT1 core reset	Core Reset	See Chapter 14 <i>Watchdog Timers (WDT)</i>
0x09	RWDT core reset	Core Reset	See Chapter 14 <i>Watchdog Timers (WDT)</i>
0x14	eFuse reset	Core Reset	Triggered by eFuse CRC error
0x15	USB (UART) reset	Core Reset	Triggered when external USB host sends a specific command to the Serial interface of USB Serial/JTAG Controller. See Chapter 31 <i>USB Serial/JTAG Controller (USB_SERIAL_JTAG)</i>
0x16	USB (JTAG) reset	Core Reset	Triggered when external USB host sends a specific command to the JTAG interface of USB Serial/JTAG Controller. See Chapter 31 <i>USB Serial/JTAG Controller (USB_SERIAL_JTAG)</i>
0x0B	MWDT0 CPU reset	CPU Reset	See Chapter 14 <i>Watchdog Timers (WDT)</i>
0x0C	Software CPU reset	CPU Reset	Triggered by configuring <code>LP_AON_CPU_CORE0_SW_RESET</code>
0x0D	RWDT CPU reset	CPU Reset	See Chapter 14 <i>Watchdog Timers (WDT)</i>
0x11	MWDT1 CPU reset	CPU Reset	See Chapter 14 <i>Watchdog Timers (WDT)</i>
0x18	JTAG CPU reset	CPU Reset	Triggered when a "JDB Resetting CPU" instruction is received

¹ Chip Reset can be triggered by the following sources:

- Triggered by chip power-on.
- Triggered by brown-out detector.

² Once brown-out status is detected, the detector will trigger System Reset or Chip Reset, depending on register configuration. See Chapter 2 *Low-Power Management [to be added later]*.

8.1.5 Peripheral Reset

Peripherals can be reset individually by configuring corresponding registers, or globally by Core Reset, System Reset, or Chip Reset. The reset registers of ESP32-C6 peripherals are merged to Power/Clock/Reset (PCR) module. See Section 8.4 *Register Summary* for detailed information.

8.2 Clock

8.2.1 Overview

ESP32-C6 clocks are mainly sourced from oscillator (OSC), RC, and PLL circuit, and then processed by the dividers or selectors, which allows most functional modules to select their working clock according to their power consumption and performance requirements. Figure 8-2 shows the system clock structure.

8.2.2 Architectural Overview

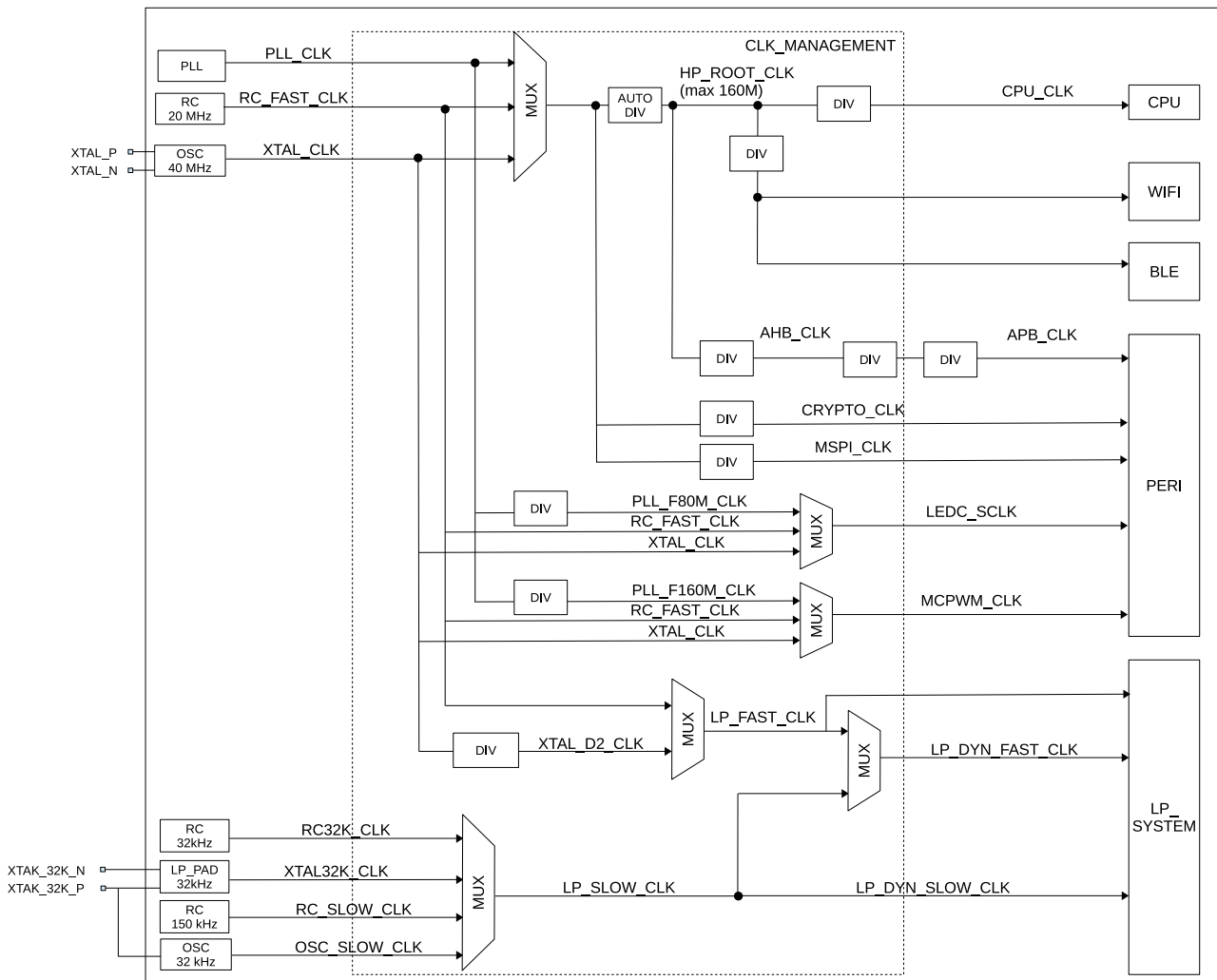

Figure 8-2. System Clock

Note:

The AUTODIV in the figure will divide 480 MHz PLL_CLK into 160 MHz clock by hardware control only when the MUX before selects PLL_CLK. If the MUX before selects RC_FAST_CLK or XTAL_CLK, AUTODIV will not divide the clock

frequency.

8.2.3 Features

ESP32-C6 clocks can be classified into two types depending on their frequencies:

- High speed clocks for devices working at a higher frequency, such as CPU and digital peripherals
 - PLL_CLK (480 MHz): internal PLL clock. Its reference clock is XTAL_CLK.
 - XTAL_CLK (40 MHz): external crystal clock
- Slow speed clocks for LP system and some peripherals working in low-power mode
 - XTAL32K_CLK (32 kHz): external crystal clock
 - RC_FAST_CLK (17.5 MHz by default): internal fast RC oscillator with adjustable frequency
 - RC_SLOW_CLK (136 kHz by default): internal slow RC oscillator with adjustable frequency
 - RC32K_CLK (32 kHz): internal slow RC oscillator
 - OSC_SLOW_CLK (32 kHz by default): external slow clock input through [XTAL_32K_P](#). After configuring this GPIO, also configure the Hold function (see [Chapter 7 IO MUX and GPIO Matrix \(GPIO, IO MUX\) > 7.9 Pin Hold Feature](#))

8.2.4 Functional Description

8.2.4.1 HP System Clock

As Figure 8-2 shows, CPU_CLK is the master clock for CPU and it can be as high as 160 MHz when CPU works in high performance mode. Alternatively, CPU can run at lower frequencies, such as at 2 MHz, to achieve lower power consumption. CPU_CLK shares the same clock sources with AHB_CLK, CRYPTO_CLK, and MSPI_CLK. Users can select from XTAL_CLK, PLL_CLK, or RC_FAST_CLK as the clock source of CPU_CLK by configuring [PCR_SOC_CLK_SEL](#). See Table 8-2 and Table 8-3. When PLL_CLK is selected as the clock source, CPU_CLK will be divided into 160 MHz clock by hardware control before the configurable divider, please refer to AUTODIV in figure 8-2. By default, the CPU clock is sourced from XTAL_CLK with a divider of 1, i.e., the CPU clock is 40 MHz.

Table 8-2. CPU_CLK Clock Source

PCR_SOC_CLK_SEL	CPU Clock Source
0	XTAL_CLK
1	PLL_CLK
2	RC_FAST_CLK

Table 8-3. Frequency of CPU_CLK, AHB_CLK and HP_ROOT_CLK

Clock	Source	Frequency
HP_ROOT_CLK ¹	PLL_CLK	480 MHz, will be divided to 160 MHz clock by hardware
	XTAL_CLK	40 MHz
	RC_FAST_CLK	17.5 MHz
CPU_CLK ²	PLL_CLK	$f_{HP_ROOT_CLK} / (PCR_CPU_HS_DIV_NUM + 1)$
	Low-speed clock source ³	$f_{HP_ROOT_CLK} / (PCR_CPU_LS_DIV_NUM + 1)$
AHB_CLK ⁴	PLL_CLK	$f_{HP_ROOT_CLK} / (PCR_AHB_HS_DIV_NUM + 1)$
	Low-speed clock source	$f_{HP_ROOT_CLK} / (PCR_AHB_LS_DIV_NUM + 1)$

¹ HP_ROOT_CLK: the clock source of CPU_CLK, AHB_CLK and APB_CLK. If the clock source is PLL_CLK, it will be divided into 160 MHz clock by hardware after selecting the source.

² CPU_CLK frequency must be an integer multiple of AHB_CLK frequency.

³ XTAL_CLK and RC_FAST_CLK

⁴ AHB_CLK frequency can not exceed 40 MHz.

The available divider values for CPU_CLK and AHB_CLK are as follows:

- PCR_CPU_HS_DIV_NUM: 0, 1, 3
- PCR_CPU_LS_DIV_NUM: 0, 1, 3, 7, 15, 31
- PCR_AHB_HS_DIV_NUM: 3, 7, 15
- PCR_AHB_LS_DIV_NUM: 0, 1, 3, 7, 15, 31

As shown in 8-2, to generate APB_CLK, AHB_CLK might be divided twice. The first division is compulsory. That is, AHB_CLK is always divided by the divisor (PCR_APB_DIV_NUM + 1). The second division (also called automatic frequency reduction) is optional. When there is no request from the host in the chip to access peripheral registers, AHB_CLK will be further divided by APB_DECREASE_DIV_NUM + 1. If the host initiates a request to access peripheral registers, APB_CLK will be restored to the frequency after the first division.

Note that the chip's performance will degrade due to the automatic frequency reduction. This function can be disabled (already disabled by default) by configuring APB_DECREASE_DIV_NUM to 0.

8.2.4.2 LP System Clock

The LP system can operate when most other clocks are disabled. LP system clocks include LP_SLOW_CLK and LP_FAST_CLK.

The clock sources for LP_SLOW_CLK and LP_FAST_CLK are low-frequency clocks:

- LP_SLOW_CLK can be derived from:
 - RC_SLOW_CLK
 - XTAL32K_CLK
 - RC32K_CLK
 - OSC_SLOW_CLK
- LP_FAST_CLK can be derived from:

- 16 MHz XTAL_D2_CLK, which is XTAL_CLK divided by 2
- RC_FAST_CLK
- PLL_LP_CLK

The clock source of LP_DYN_SLOW_CLK is LP_SLOW_CLK.

The clock source of LP_DYN_FAST_CLK depends on the chip's power mode (see Chapter 2 *Low-Power Management [to be added later]*).

- Select LP_FAST_CLK as its clock source in Active and Modem-sleep mode
- Select LP_SLOW_CLK as its clock source in Light-sleep and Deep-sleep mode

8.2.4.3 Peripheral Clocks

Table 8-4, Table 8-5, and Table 8-6 list the derived clocks source and HP clocks/LP clocks for each peripheral.

Table 8-4. Derived Clock Source

Derived Clock	Source Clock		Derived Clock						Source Clock											Derived Clock			Source Clock	
	XTAL_CLK	40 MHz	PLL_CLK						RC_FAST_CLK 17.5 MHz	RC_SLOW_CLK 136 kHz	RC32K_CLK & OSC_SLOW_CLK 32 kHz	XTAL32K_CLK 32 kHz	HP_ROOT_CLK 160 MHz/40 MHz/17.5 MHz	MSPI_CLK	CRYPTO_CLK	APB_CLK	AHB_CLK	CPU_CLK	LP_DYN_FAST_CLK	LP_DYN_SLOW_CLK	XTAL_D2_CLK 20 MHz	LP_FAST_CLK	CLOCK FROM IO	
			480 MHz	240 MHz	160 MHz	80 MHz	48 MHz																	
PLL_48M ~ 240M_CLK			Y																					
HP_ROOT_CLK	Y	Y					Y																	
MSPI_CLK												Y												
CPYPTO_CLK												Y												
APB_CLK												Y												
AHB_CLK												Y												
CPU_CLK												Y												
LP_DYN_FAST_CLK									Y		Y	Y										Y		
LP_DYN_SLOW_CLK									Y		Y	Y												
XTAL_D2_CLK	Y																							
LP_FAST_CLK							Y																	

Table 8-5. HP Clocks Used by Each Peripheral

Peripheral	Source Clock		Derived Clock						Source Clock											Derived Clock			Source Clock	
	XTAL_CLK	40 MHz	PLL_CLK						RC_FAST_CLK 17.5 MHz	RC_SLOW_CLK 136 kHz	RC32K_CLK & OSC_SLOW_CLK 32 kHz	XTAL32K_CLK 32 kHz	HP_ROOT_CLK 160 MHz/40 MHz/17.5 MHz	MSPI_CLK	CRYPTO_CLK	APB_CLK	AHB_CLK	CPU_CLK	LP_DYN_FAST_CLK	LP_DYN_SLOW_CLK	XTAL_D2_CLK 20 MHz	LP_FAST_CLK	CLOCK FROM IO	
			480 MHz	240 MHz	160 MHz	80 MHz	48 MHz																	
Timer Group (TIMG)	Y						Y																	
Main System Watchdog Timers (MWDI)	Y						Y																	
I2S Controller (I2S)	Y		Y	Y																				I2S_MCLK_PAD
UART Controller (UART)	Y						Y																	
Remote Control Peripheral (RMT)	Y						Y																	
Motor Control PWM (MCPWM)	Y			Y				Y																
I2C Controller (I2C)	Y							Y																
SPI2	Y						Y																	
SAR ADC	Y						Y																	
USB Serial/JTAG Controller (USB_SERIAL_JTAG)								Y																
Two-wire Automotive Interface (TWAI)	Y							Y																
LED PWM Controller (LEDC)	Y						Y																	
System Timer (SYSTIMER)	Y							Y																
Parallel IO Controller (PARL_IO)	Y		Y					Y																PARL_CLK_PAD

Continued on the next page...

Table 8-5 – Continued from the previous page...

Peripheral	Source Clock		Derived Clock					Source Clock										Derived Clock				Source Clock
	XTAL_CLK	PLL_CLK					RC_FAST_CLK 17.5 MHz	RC_SLOW_CLK 136 kHz	RC32K_CLK & OSC_SLOW_CLK 32 kHz	XTAL32K CLK 32 kHz	HP_ROOT_CLK 160 MHz/40 MHz/17.5 MHz	MSPi_CLK	CRYPTO_CLK	APB_CLK	AHB_CLK	CPU_CLK	LP_DYN_	LP_DYN_	XTAL_D2_CLK 20 MHz	LP_FAST_CLK	CLOCK FROM IO	
		40 MHz	480 MHz	240 MHz	160 MHz	80 MHz											48 MHz	FAST_CLK				SLOW_CLK
IO MUX	Y				Y																	
AES Accelerator (AES)/SHA Accelerator (SHA)/RSA Accelerator (RSA)/ECC Accelerator (ECC)/Digital Signature (DS)/HMAC Accelerator (HMAC)												Y										
Interrupt Matrix (INTMTX)														Y								
Pulse Count Controller (PCNT)													Y									
Event Task Matrix (SOC_ETM)														Y								
GDMA Controller (GDMA)														Y								
UHCI														Y								

Table 8-6. LP Clocks Used by Each Peripheral

Peripheral	Source Clock		Derived Clock					Source Clock										Derived Clock				Source Clock
	XTAL_CLK	PLL_CLK					RC_FAST_CLK 17.5 MHz	RC_SLOW_CLK 136 kHz	RC32K_CLK & OSC_SLOW_CLK 32 kHz	XTAL32K CLK 32 kHz	HP_ROOT_CLK 160 MHz/40 MHz/17.5 MHz	MSPi_CLK	CRYPTO_CLK	APB_CLK	AHB_CLK	CPU_CLK	LP_DYN_	LP_DYN_	XTAL_D2_CLK 20 MHz	LP_FAST_CLK	CLOCK FROM IO	
		40 MHz	480 MHz	240 MHz	160 MHz	80 MHz											48 MHz	FAST_CLK				SLOW_CLK
eFuse Controller (eFuse)																		Y				
RTC Watchdog Timer (RWDT)																Y	Y					
RTC Timer																Y	Y					
Brownout Detector																Y						
Power Management Unit (PMU)																Y	Y		Y			
UART Controller (LP_UART)																		Y	Y			
Low-Power CPU																				Y		
I2C Controller (LP_I2C)																		Y	Y			
LP_IO MUX																Y						

PLL_CLK

PLL_F480M_CLK is the source clock of PLL which is 480 MHz. PLL_D2_CLK (240 MHz), PLL_F160M_CLK, PLL_F80M_CLK, and PLL_F48M_CLK are divided from PLL_F480M_CLK.

CRYPTO_CLK

As shown in Figure 8-2, CRYPTO_CLK shares the same clock sources with CPU_CLK, and its frequency is up to 160 MHz.

To protect encryption and decryption peripherals from DPA (Differential Power Analysis) attacks, a random divider strategy is implemented for the function clock of encryption and decryption peripherals. Four security levels are available, depending on the range of random divider. Users can select the security level by configuring [HP_SYSTEM_SEC_DPA_CONF_REG](#). If [HP_SYSTEM_SEC_DPA_CFG_SEL](#) is set to 1, the security level is determined by configuration of [EFUSE_SEC_DPA_LEVEL](#), otherwise, by the value of [HP_SYSTEM_SEC_DPA_LEVEL](#).

LED_PWM

LEDC module uses PLL_F80M_CLK, RC_FAST_CLK and XTAL_CLK as clock source when APB_CLK is disabled. In other words, when the system is in low-power mode, most peripherals will be halted (APB_CLK is turned off), but LEDC can work normally via RC_FAST_CLK.

8.2.4.4 Wi-Fi and Bluetooth LE Clock

Wi-Fi and Bluetooth LE can work only when CPU_CLK uses PLL_CLK as its clock source. Suspending PLL_CLK requires that Wi-Fi and Bluetooth LE have entered low-power mode first.

8.3 Programming Procedures

8.3.1 HP System Clock Configuration

The clock source of HP_ROOT_CLK can be configured via [PCR_SOC_CLK_SEL](#).

- If PLL_CLK is selected as the clock source of HP_ROOT_CLK,
 - the clock divisor for CPU_CLK can be configured via [PCR_CPU_HS_DIV_NUM](#).
 - the clock divisor for AHB_CLK can be configured via [PCR_AHB_HS_DIV_NUM](#).
- If XTAL_CLK or RC_FAST_CLK is selected as the clock source of HP_ROOT_CLK,
 - the clock divisor for CPU_CLK can be configured via [PCR_CPU_LS_DIV_NUM](#).
 - the clock divisor for AHB_CLK can be configured via [PCR_AHB_LS_DIV_NUM](#).

8.3.2 LP System Clock Configuration

The clock source of LP_SLOW_CLK can be configured via [LP_CLKRST_SLOW_CLK_SEL](#).

The clock source of LP_FAST_CLK can be configured via [LP_CLKRST_FAST_CLK_SEL](#).

8.3.3 Peripheral Clock Reset and Configuration

The clocks of most peripherals can be classified into two types:

- Bus clock: used to configure peripheral registers.
- Function clock: such as UART's reference clock, used by peripherals to operate.

The operating clock (function clock) of most peripherals can be selected from multiple clock sources. In the description of the gating registers, it will be stated whether the register belongs to the bus clock (AHB_CLK, APB_CLK) gating register or the function clock gating register.

Bus clock switches, function clock switches, and the configuration registers for clock source selection and clock frequency division are grouped into the PCR module. For more information, see Section 8.4 *Register Summary*.

When a peripheral is not working, users can turn off its function clock by configuring related registers. Turning off the peripheral's function clock does not affect the rest of the system.

Take I2C clock configuration as an example.

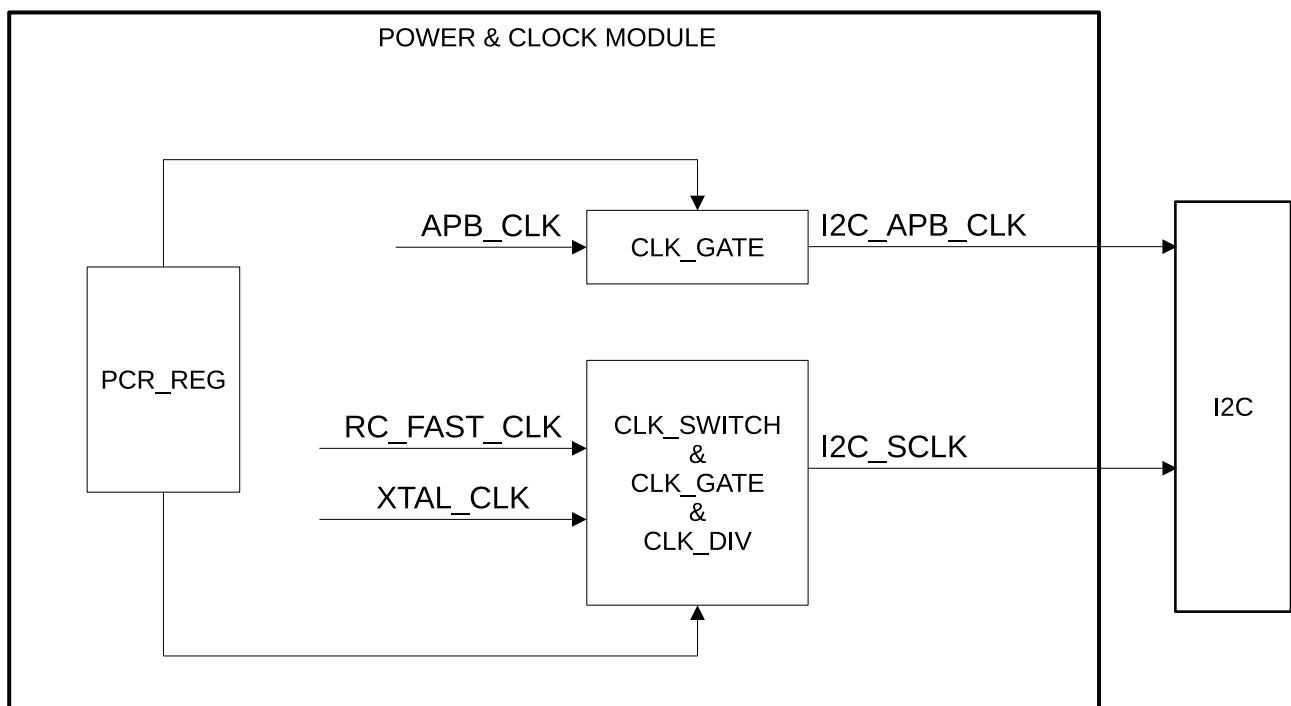

Figure 8-3. Clock Configuration Example

Figure 8-3 shows the clock structure of I2C. The clock structure of other peripherals is similar to this one. CLK_SWITCH is used to select a clock output and CLK_GATE to turn on/off the clock.

In scenarios that require low power consumption, when the peripheral is not in use, in addition to turning off the function clock, the bus clock of the peripheral can also be turned off to further lower power consumption.

Note that if you turn off the bus clock first, the function clock may continue working. It is recommended to turn off the function clock first and then the bus clock when turning off the clocks. It is also recommended to turn on the bus clock first and then the function clock when turning on the clocks.

8.4 Register Summary

8.4.1 PCR Registers

The addresses in this section are relative to the Power/Clock/Reset (PCR) Register base address provided in Table 5-2 in Chapter 5 *System and Memory*.

The abbreviations given in Column **Access** are explained in Section *Access Types for Registers*.

Name	Description	Address	Access
Configuration Register			
PCR_UART0_CONF_REG	UART0 configuration register	0x0000	R/W
PCR_UART0_SCLK_CONF_REG	UART0_SCLK configuration register	0x0004	R/W
PCR_UART0_PD_CTRL_REG	UART0 power control register	0x0008	R/W
PCR_UART1_CONF_REG	UART1 configuration register	0x000C	R/W
PCR_UART1_SCLK_CONF_REG	UART1_SCLK configuration register	0x0010	R/W
PCR_UART1_PD_CTRL_REG	UART1 power control register	0x0014	R/W
PCR_I2C_CONF_REG	I2C configuration register	0x0020	R/W
PCR_I2C_SCLK_CONF_REG	I2C_SCLK configuration register	0x0024	R/W
PCR_UHCI_CONF_REG	UHCI configuration register	0x0028	R/W
PCR_RMT_CONF_REG	RMT configuration register	0x002C	R/W
PCR_RMT_SCLK_CONF_REG	RMT_SCLK configuration register	0x0030	R/W
PCR_LEDC_CONF_REG	LEDC configuration register	0x0034	R/W
PCR_LEDC_SCLK_CONF_REG	LEDC_SCLK configuration register	0x0038	R/W
PCR_TIMERGROUP0_CONF_REG	TIMERGROUP0 configuration register	0x003C	R/W
PCR_TIMERGROUP0_TIMER_CLK_CONF_REG	TIMERGROUP0_TIMER_CLK configuration register	0x0040	R/W
PCR_TIMERGROUP0_WDT_CLK_CONF_REG	TIMERGROUP0_WDT_CLK configuration register	0x0044	R/W
PCR_TIMERGROUP1_CONF_REG	TIMERGROUP1 configuration register	0x0048	R/W
PCR_TIMERGROUP1_TIMER_CLK_CONF_REG	TIMERGROUP1_TIMER_CLK configuration register	0x004C	R/W
PCR_TIMERGROUP1_WDT_CLK_CONF_REG	TIMERGROUP1_WDT_CLK configuration register	0x0050	R/W
PCR_SYSTIMER_CONF_REG	SYSTIMER configuration register	0x0054	R/W
PCR_SYSTIMER_FUNC_CLK_CONF_REG	SYSTIMER_FUNC_CLK configuration register	0x0058	R/W
PCR_TWAI0_CONF_REG	TWAI0 configuration register	0x005C	R/W
PCR_TWAI0_FUNC_CLK_CONF_REG	TWAI0_FUNC_CLK configuration register	0x0060	R/W
PCR_TWAI1_CONF_REG	TWAI1 configuration register	0x0064	R/W
PCR_TWAI1_FUNC_CLK_CONF_REG	TWAI1_FUNC_CLK configuration register	0x0068	R/W
PCR_I2S_CONF_REG	I2S configuration register	0x006C	R/W
PCR_I2S_TX_CLKM_CONF_REG	I2S_TX_CLKM configuration register	0x0070	R/W
PCR_I2S_TX_CLKM_DIV_CONF_REG	I2S_TX_CLKM_DIV configuration register	0x0074	R/W
PCR_I2S_RX_CLKM_CONF_REG	I2S_RX_CLKM configuration register	0x0078	R/W
PCR_I2S_RX_CLKM_DIV_CONF_REG	I2S_RX_CLKM_DIV configuration register	0x007C	R/W
PCR_SARADC_CONF_REG	SARADC configuration register	0x0080	R/W
PCR_SARADC_CLKM_CONF_REG	SARADC_CLKM configuration register	0x0084	R/W

Name	Description	Address	Access
PCR_TSENS_CLK_CONF_REG	TSENS_CLK configuration register	0x0088	R/W
PCR_USB_SERIAL_JTAG_CONF_REG	_SERIAL_JTAG configuration register	0x008C	R/W
PCR_INTMTX_CONF_REG	INTMTX configuration register	0x0090	R/W
PCR_PCNT_CONF_REG	PCNT configuration register	0x0094	R/W
PCR_ETM_CONF_REG	ETM configuration register	0x0098	R/W
PCR_PWM_CONF_REG	PWM configuration register	0x009C	R/W
PCR_PWM_CLK_CONF_REG	PWM_CLK configuration register	0x00A0	R/W
PCR_PARL_IO_CONF_REG	PARL_IO configuration register	0x00A4	R/W
PCR_PARL_CLK_RX_CONF_REG	PARL_CLK_RX configuration register	0x00A8	R/W
PCR_PARL_CLK_TX_CONF_REG	PARL_CLK_TX configuration register	0x00AC	R/W
PCR_SDIO_SLAVE_CONF_REG	SDIO_SLAVE configuration register	0x00B0	R/W
PCR_GDMA_CONF_REG	GDMA configuration register	0x00BC	R/W
PCR_SPI2_CONF_REG	SPI2 configuration register	0x00C0	R/W
PCR_SPI2_CLKM_CONF_REG	SPI2_CLKM configuration register	0x00C4	R/W
PCR_AES_CONF_REG	AES configuration register	0x00C8	R/W
PCR_SHA_CONF_REG	SHA configuration register	0x00CC	R/W
PCR_RSA_CONF_REG	RSA configuration register	0x00D0	R/W
PCR_RSA_PD_CTRL_REG	RSA power control register	0x00D4	R/W
PCR_ECC_CONF_REG	ECC configuration register	0x00D8	R/W
PCR_ECC_PD_CTRL_REG	ECC power control register	0x00DC	R/W
PCR_DS_CONF_REG	DS configuration register	0x00E0	R/W
PCR_HMAC_CONF_REG	HMAC configuration register	0x00E4	R/W
PCR_IOMUX_CONF_REG	IOMUX configuration register	0x00E8	R/W
PCR_IOMUX_CLK_CONF_REG	IOMUX_CLK configuration register	0x00EC	R/W
PCR_MEM_MONITOR_CONF_REG	MEM_MONITOR configuration register	0x00F0	R/W
PCR_TRACE_CONF_REG	TRACE configuration register	0x00FC	R/W
PCR_ASSIST_CONF_REG	ASSIST configuration register	0x0100	R/W
PCR_CACHE_CONF_REG	CACHE configuration register	0x0104	R/W
PCR_MODEM_APB_CONF_REG	MODEM_APB configuration register	0x0108	R/W
PCR_TIMEOUT_CONF_REG	TIMEOUT configuration register	0x010C	R/W
PCR_SYSCLK_CONF_REG	SYSCLK configuration register	0x0110	varies
PCR_CPU_WAITI_CONF_REG	CPU_WAITI configuration register	0x0114	R/W
PCR_CPU_FREQ_CONF_REG	CPU_FREQ configuration register	0x0118	R/W
PCR_AHB_FREQ_CONF_REG	AHB_FREQ configuration register	0x011C	R/W
PCR_APB_FREQ_CONF_REG	APB_FREQ configuration register	0x0120	R/W
PCR_PLL_DIV_CLK_EN_REG	SPLL DIV clock-gating configuration register	0x0128	R/W
PCR_CTRL_32K_CONF_REG	32KHz clock configuration register	0x0134	R/W
PCR_SRAM_POWER_CONF_REG	HP SRAM/ROM configuration register	0x0138	R/W
PCR_RESET_EVENT_BYPASS_REG	Reset event bypass backdoor configuration register	0x0FF0	R/W
Frequency Statistics Register			
PCR_SYSCLK_FREQ_QUERY_0_REG	SYSCLK frequency query register 0	0x0124	HRO
Version Register			

Name	Description	Address	Access
PCR_DATE_REG	Version control register	0x0FFC	R/W

8.4.2 LP System Clock Registers

The addresses of the last two registers in this section are relative to the Low-power Always-on Register (LP_AON) base address. The other addresses in this section are relative to the Low-power Clock/Reset Register (LP_CLKRST) base address. For base address, please refer to Table 5-2 in Chapter 5 *System and Memory*.

The abbreviations given in Column **Access** are explained in Section *Access Types for Registers*.

Name	Description	Address	Access
Configuration Registers			
LP_CLKRST_LP_CLK_CONF_REG	Configures the root clk of LP system	0x0000	R/W
LP_CLKRST_LP_CLK_PO_EN_REG	Configures the clk gate to pad	0x0004	R/W
LP_CLKRST_LP_CLK_EN_REG	Configure LP root clk source gate	0x0008	R/W
LP_CLKRST_LP_RST_EN_REG	Configures the peri of LP system software reset	0x000C	R/W
LP_CLKRST_RESET_CAUSE_REG	Represents the reset casue	0x0010	varies
LP_CLKRST_CPU_RESET_REG	Configures CPU reset	0x0014	R/W
LP_CLKRST_FOSC_CNTL_REG	Configures the RC_FAST_CLK frequency	0x0018	R/W
LP_CLKRST_RC32K_CNTL_REG	Configures the RC32K_CLK frequency	0x001C	R/W
LP_CLKRST_CLK_TO_HP_REG	Configures the clk gate of LP clk to HP system	0x0020	R/W
LP_CLKRST_LPMEM_FORCE_REG	Configures the LP_MEM clk gate force parameter	0x0024	R/W
LP_CLKRST_LPPERI_REG	Configures the LP peri clk	0x0028	R/W
LP_CLKRST_XTAL32K_REG	Configures the XTAL32K parameter	0x002C	R/W
LP_CLKRST_DATE_REG	Version control register	0x03FC	R/W
LP_AON_SYS_CFG_REG	Software system reset	0x0034	WT
LP_AON_CPUCORE0_CFG_REG	Software CPU reset	0x0038	WT

8.5 Registers

8.5.1 PCR Registers

The addresses in this section are relative to the Power/Clock/Reset (PCR) Register base address provided in Table 5-2 in Chapter 5 *System and Memory*.

Register 8.2. PCR_UART0_SCLK_CONF_REG (0x0004)

(reserved)										PCR_UART0_SCLK_EN			PCR_UART0_SCLK_SEL			PCR_UART0_SCLK_DIV_NUM			PCR_UART0_SCLK_DIV_B		PCR_UART0_SCLK_DIV_A			
31							23	22	21	20	19				12	11			6	5				0
0 0 0 0 0 0 0 0 0 0										1	3			0			0		0			Reset		

PCR_UART0_SCLK_DIV_A Configures the denominator of the frequency divider factor for UART0 function clock.
(R/W)

PCR_UART0_SCLK_DIV_B Configures the numerator of the frequency divider factor for UART0 function clock.
(R/W)

PCR_UART0_SCLK_DIV_NUM Configures the integral part of the frequency divider factor for UART0 function clock.
(R/W)

PCR_UART0_SCLK_SEL Configures to select clock source.

- 0: Not select any clock
- 1: Select PLL_F80M_CLK
- 2: Select RC_FAST_CLK
- 3: Select XTAL_CLK

(R/W)

PCR_UART0_SCLK_EN Configures whether or not to enable UART0 function clock.

- 0: Not enable
- 1: Enable

(R/W)

Register 8.3. PCR_UART0_PD_CTRL_REG (0x0008)

(reserved)																												PCR_UART0_MEM_FORCE_PD PCR_UART0_MEM_FORCE_PU (reserved)					
31																													3	2	1	0	
0	0	0	0	0	0	0	0	0	0	0	0	0	0	0	0	0	0	0	0	0	0	0	0	0	0	0	0	0	0	0	1	0	Reset

PCR_UART0_MEM_FORCE_PU Configures whether or not to force power up UART0 memory.

0: Not force power up UART0 memory

1: Force power up UART0 memory

(R/W)

PCR_UART0_MEM_FORCE_PD Configures whether or not to force power down UART0 memory.

0: Not force power down UART0 memory

1: Force power down UART0 memory

(R/W)

Register 8.4. PCR_UART1_CONF_REG (0x000C)

(reserved)																												PCR_UART1_RST_EN PCR_UART1_CLK_EN			
31																													2	1	0
0	0	0	0	0	0	0	0	0	0	0	0	0	0	0	0	0	0	0	0	0	0	0	0	0	0	0	0	0	0	1	Reset

PCR_UART1_CLK_EN Configures whether or not to enable UART1 APB clock.

0: Not enable

1: Enable

(R/W)

PCR_UART1_RST_EN Configures whether or not to reset UART1 module.

0: Not reset

1: Reset

(R/W)

Register 8.5. PCR_UART1_SCLK_CONF_REG (0x0010)

(reserved)					PCR_UART1_SCLK_EN		PCR_UART1_SCLK_SEL			PCR_UART1_SCLK_DIV_NUM			PCR_UART1_SCLK_DIV_B		PCR_UART1_SCLK_DIV_A			
31					23	22	21	20	19			12	11			6	5	0
0 0 0 0 0 0 0 0 0 0					1	3			0			0		0			Reset	

PCR_UART1_SCLK_DIV_A Configures the denominator of the frequency divider factor for UART1 function clock.
(R/W)

PCR_UART1_SCLK_DIV_B Configures the numerator of the frequency divider factor for UART1 function clock.
(R/W)

PCR_UART1_SCLK_DIV_NUM Configures the integral part of the frequency divider factor for UART1 function clock.
(R/W)

PCR_UART1_SCLK_SEL Configures to select clock source.

- 0: Not select any clock
- 1: Select PLL_F80M_CLK
- 2: Select RC_FAST_CLK
- 3: Select XTAL_CLK

(R/W)

PCR_UART1_SCLK_EN Configures whether or not to enable UART1 function clock.

- 0: Not enable
- 1: Enable

(R/W)

Register 8.6. PCR_UART1_PD_CTRL_REG (0x0014)

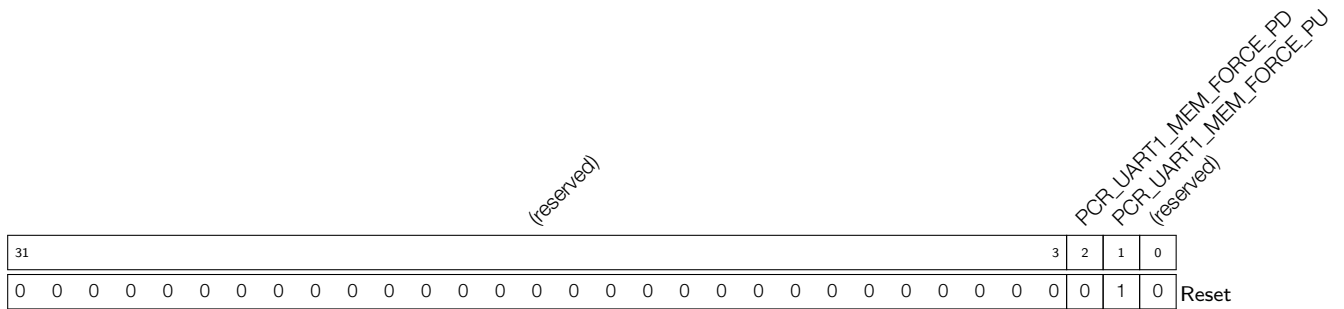

PCR_UART1_MEM_FORCE_PU Configures whether or not to force power up UART1 memory.

0: Not force power up UART1 memory

1: Force power up UART1 memory

(R/W)

PCR_UART1_MEM_FORCE_PD Configures whether or not to force power down UART1 memory.

0: Not force power down UART1 memory

1: Force power down UART1 memory

(R/W)

Register 8.7. PCR_I2C_CONF_REG (0x0020)

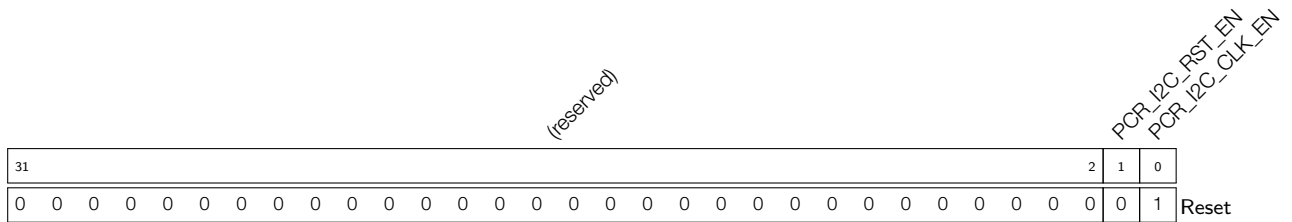

PCR_I2C_CLK_EN Configures whether or not to enable I2C APB clock.

0: Not enable

1: Enable

(R/W)

PCR_I2C_RST_EN Configures whether or not to reset I2C module.

0: Not reset

1: Reset

(R/W)

Register 8.8. PCR_I2C_SCLK_CONF_REG (0x0024)

(reserved)								PCR_I2C_SCLK_EN (reserved)			PCR_I2C_SCLK_SEL				PCR_I2C_SCLK_DIV_NUM				PCR_I2C_SCLK_DIV_B		PCR_I2C_SCLK_DIV_A				
31								23	22	21	20	19				12	11			6	5				0
0	0	0	0	0	0	0	0	0	0	0	1	0	0	0			0		0			0			Reset

PCR_I2C_SCLK_DIV_A Configures the denominator of the frequency divider factor for I2C function clock.
(R/W)

PCR_I2C_SCLK_DIV_B Configures the numerator of the frequency divider factor for I2C function clock.
(R/W)

PCR_I2C_SCLK_DIV_NUM Configures the integral part of the frequency divider factor for I2C function clock.
(R/W)

PCR_I2C_SCLK_SEL Configures to select clock source.
0 (default): Select XTAL_CLK
1: Select RC_FAST_CLK
(R/W)

PCR_I2C_SCLK_EN Configures whether or not to enable I2C function clock.
0: Not enable
1: Enable
(R/W)

Register 8.9. PCR_UHCI_CONF_REG (0x0028)

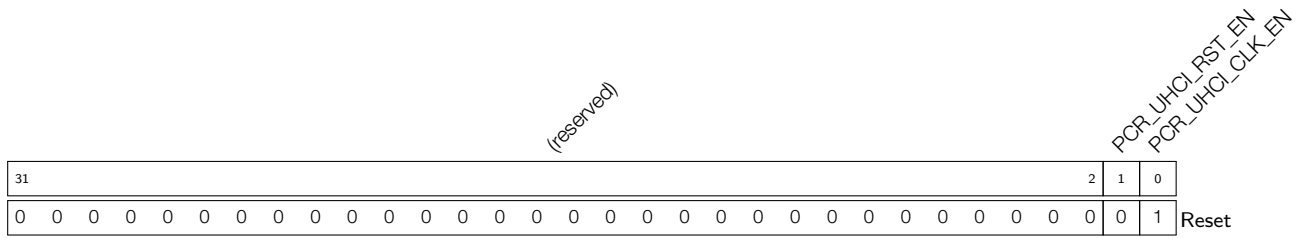

PCR_UHCI_CLK_EN Configures whether or not to enable UHCI clock.

- 0: Not enable
 - 1: Enable
- (R/W)

PCR_UHCI_RST_EN Configures whether or not to reset UHCI module.

- 0: Not reset
 - 1: Reset
- (R/W)

Register 8.10. PCR_RMT_CONF_REG (0x002C)

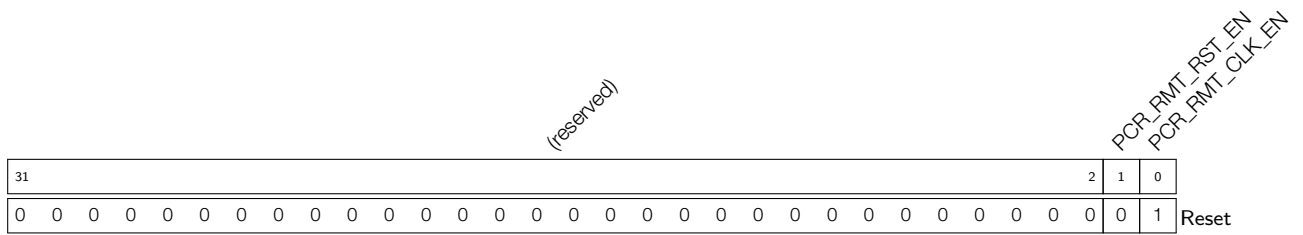

PCR_RMT_CLK_EN Configures whether or not to enable RMT APB clock.

- 0: Enable
 - 1: Not enable
- (R/W)

PCR_RMT_RST_EN Configures whether or not to reset RMT module.

- 0: Not reset
 - 1: Reset
- (R/W)

Register 8.11. PCR_RMT_SCLK_CONF_REG (0x0030)

(reserved)										PCR_RMT_SCLK_EN			PCR_RMT_SCLK_SEL			PCR_RMT_SCLK_DIV_NUM			PCR_RMT_SCLK_DIV_B		PCR_RMT_SCLK_DIV_A				
31								23	22	21	20	19				12	11			6	5				0
0	0	0	0	0	0	0	0	0	0	1	1	1			0		0						0		

Reset

PCR_RMT_SCLK_DIV_A Configures the denominator of the frequency divider factor for RMT function clock.

(R/W)

PCR_RMT_SCLK_DIV_B Configures the numerator of the frequency divider factor for RMT function clock.

(R/W)

PCR_RMT_SCLK_DIV_NUM Configures the integral part of the frequency divider factor for RMT function clock.

(R/W)

PCR_RMT_SCLK_SEL Configures to select clock source.

0: Not select any clock

1 (default): Select PLL_F80M_CLK

2: Select RC_FAST_CLK

3: Select XTAL_CLK

(R/W)

PCR_RMT_SCLK_EN Configures whether or not to enable RMT function clock.

0: Not enable

1: Enable

(R/W)

Register 8.18. PCR_TIMERGROUP1_TIMER_CLK_CONF_REG (0x004C)

(reserved)								PCR_TG1_TIMER_CLK_EN				(reserved)																	
31								23	22	21	20	19																	0
0 0 0 0 0 0 0 0								1	0	0 0																Reset			

PCR_TG1_TIMER_CLK_SEL Configures to select clock source.

0 (default): Select XTAL_CLK

1: Select PLL_F80M_CLK

2: Select RC_FAST_CLK

3: Reserved

(R/W)

PCR_TG1_TIMER_CLK_EN Configures whether or not to enable TIMER_GROUP1 timer clock.

0: Not enable

1: Enable

(R/W)

Register 8.19. PCR_TIMERGROUP1_WDT_CLK_CONF_REG (0x0050)

(reserved)								PCR_TG1_WDT_CLK_EN				(reserved)																	
31								23	22	21	20	19																	0
0 0 0 0 0 0 0 0								1	0	0 0																Reset			

PCR_TG1_WDT_CLK_SEL Configures to select clock source.

0 (default): Select XTAL_CLK

1: Select PLL_F80M_CLK

2: Select RC_FAST_CLK

3: Reserved

(R/W)

PCR_TG1_WDT_CLK_EN Configures whether or not to enable TIMER_GROUP1 WDT clock.

0: Not enable

1: Enable

(R/W)

Register 8.20. PCR_SYSTIMER_CONF_REG (0x0054)

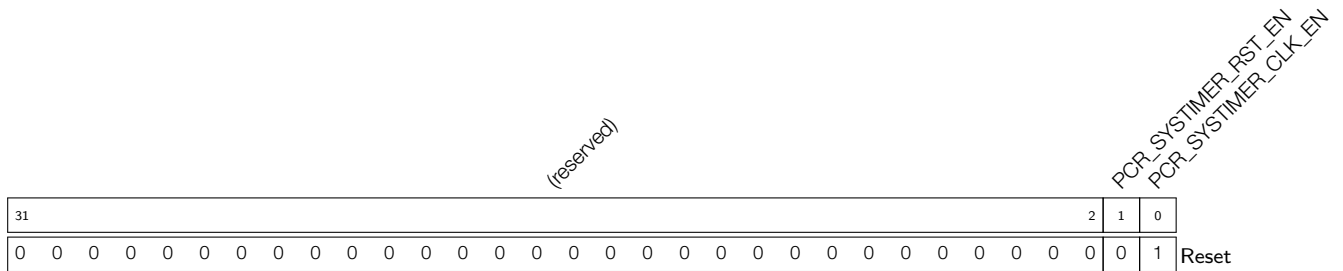

PCR_SYSTIMER_CLK_EN Configures whether or not to enable SYSTIMER APB clock.
 0: Not enable
 1: Enable
 (R/W)

PCR_SYSTIMER_RST_EN Configures whether or not to reset SYSTIMER module.
 0: Not reset
 1: Reset
 (R/W)

Register 8.21. PCR_SYSTIMER_FUNC_CLK_CONF_REG (0x0058)

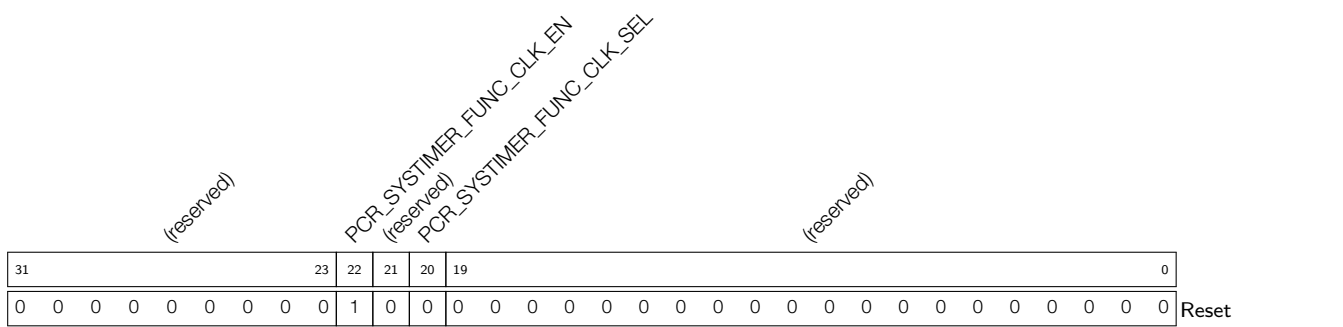

PCR_SYSTIMER_FUNC_CLK_SEL Configures to select clock source.
 0 (default): Select XTAL_CLK
 1: Select RC_FAST_CLK
 (R/W)

PCR_SYSTIMER_FUNC_CLK_EN Configures whether or not to enable SYSTIMER function clock.
 0: Not enable
 1: Enable
 (R/W)

Register 8.22. PCR_TWAI0_CONF_REG (0x005C)

31	2	1	0
0 0	0	1	0
			Reset

(reserved)

PCR_TWAI0_RST_EN
PCR_TWAI0_CLK_EN

PCR_TWAI0_CLK_EN Configures whether or not to enable TWAI0 APB clock.

- 0: Not enable
 - 1: Enable
- (R/W)

PCR_TWAI0_RST_EN Configures whether or not to reset TWAI0 module.

- 0: Not reset
 - 1: Reset
- (R/W)

Register 8.23. PCR_TWAI0_FUNC_CLK_CONF_REG (0x0060)

31	23	22	21	20	19	0
0 0 0 0 0 0 0 0 0 0	1	0	0	0 0	0	
						Reset

(reserved)

PCR_TWAI0_FUNC_CLK_EN
(reserved)
PCR_TWAI0_FUNC_CLK_SEL

(reserved)

PCR_TWAI0_FUNC_CLK_SEL Configures to select clock source.

- 0 (default): Select XTAL_CLK
 - 1: Select RC_FAST_CLK
- (R/W)

PCR_TWAI0_FUNC_CLK_EN Configures whether or not to enable TWAI0 function clock.

- 0: Not enable
 - 1: Enable
- (R/W)

Register 8.26. PCR_I2S_CONF_REG (0x006C)

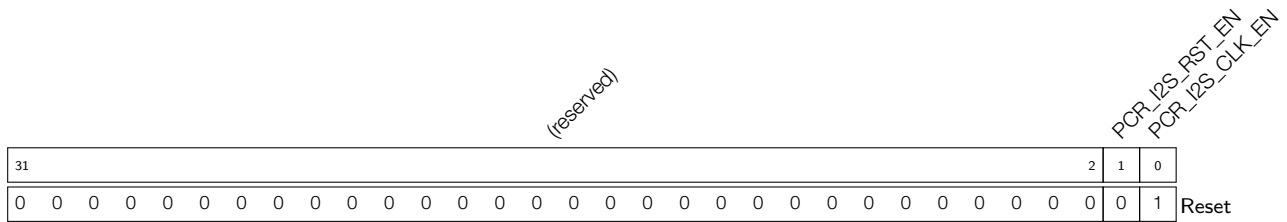

PCR_I2S_CLK_EN Configures whether or not to enable I2S APB clock.
 0: Not enable
 1: Enable
 (R/W)

PCR_I2S_RST_EN Configures whether or not to reset I2S module.
 0: Not reset
 1: Reset
 (R/W)

Register 8.27. PCR_I2S_TX_CLKM_CONF_REG (0x0070)

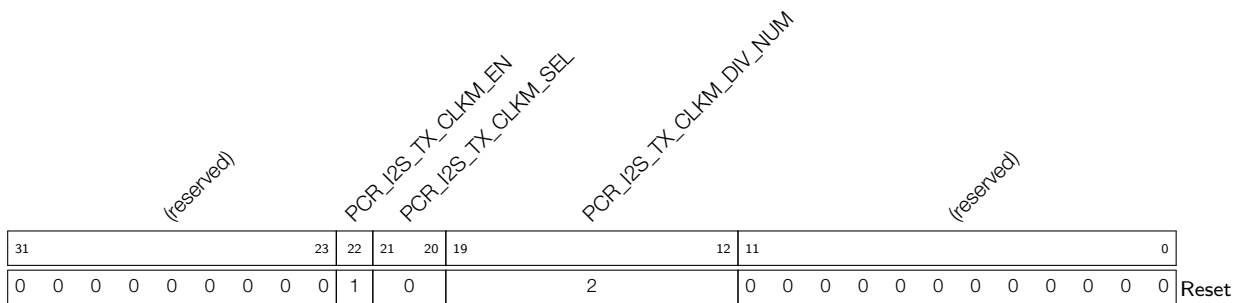

PCR_I2S_TX_CLKM_DIV_NUM Configures the integral part of I2S TX clock divider.
 (R/W)

PCR_I2S_TX_CLKM_SEL Configures to select I2S TX module source clock.
 0: Select XTAL_CLK
 1: Select PLL_F240M_CLK
 2: Select PLL_F160M_CLK
 3: Select I2S_MCLK_in
 (R/W)

PCR_I2S_TX_CLKM_EN Configures whether or not to enable I2S TX function clock.
 0: Not enable
 1: Enable
 (R/W)

Register 8.28. PCR_I2S_TX_CLKM_DIV_CONF_REG (0x0074)

(reserved)				PCR_I2S_TX_CLKM_DIV_YN1				PCR_I2S_TX_CLKM_DIV_X				PCR_I2S_TX_CLKM_DIV_Y				PCR_I2S_TX_CLKM_DIV_Z			
31	28	27	26	18	17	9	8	0											
0	0	0	0	0					1					0					

Reset

PCR_I2S_TX_CLKM_DIV_Z For $b \leq a/2$, the value of I2S_TX_CLKM_DIV_Z is b . For $b > a/2$, the value of I2S_TX_CLKM_DIV_Z is $(a - b)$.

(R/W)

PCR_I2S_TX_CLKM_DIV_Y For $b \leq a/2$, the value of I2S_TX_CLKM_DIV_Y is $(a\%b)$. For $b > a/2$, the value of I2S_TX_CLKM_DIV_Y is $(a\%(a - b))$.

(R/W)

PCR_I2S_TX_CLKM_DIV_X For $b \leq a/2$, the value of I2S_TX_CLKM_DIV_X is $\text{floor}(a/b) - 1$. For $b > a/2$, the value of I2S_TX_CLKM_DIV_X is $\text{floor}(a/(a - b)) - 1$.

(R/W)

PCR_I2S_TX_CLKM_DIV_YN1 For $b \leq a/2$, the value of I2S_TX_CLKM_DIV_YN1 is 0. For $b > a/2$, the value of I2S_TX_CLKM_DIV_YN1 is 1.

(R/W)

Note:

“a” and “b” represent the denominator and the numerator of fractional divider, respectively. For more information, see Section 29.6 in Chapter *I2S Controller (I2S)*.

Register 8.29. PCR_I2S_RX_CLKM_CONF_REG (0x0078)

(reserved)								PCR_I2S_MCLK_SEL PCR_I2S_RX_CLKM_SEL PCR_I2S_RX_CLKM_EN				PCR_I2S_RX_CLKM_DIV_NUM				(reserved)												
31								24	23	22	21	20	19					12	11									0
0 0 0 0 0 0 0 0								0	1	0	2				0 0 0 0 0 0 0 0 0 0 0 0 0 0 0 0												Reset	

PCR_I2S_RX_CLKM_DIV_NUM Configures the integral part of I2S clock divider value.
(R/W)

PCR_I2S_RX_CLKM_SEL Configures to select I2S RX module source clock.

- 0: Not select any clock
- 1: Select PLL_F240M_CLK
- 2: Select PLL_F160M_CLK
- 3: Select I2S_MCLK_in

(R/W)

PCR_I2S_RX_CLKM_EN Configures whether or not to enable I2S RX function clock.

- 0: Not enable
- 1: Enable

(R/W)

PCR_I2S_MCLK_SEL Configures to select master clock.

- 0 (default): Select I2S_RX_CLK
- 1: Select I2S_TX_CLK

(R/W)

Register 8.30. PCR_I2S_RX_CLKM_DIV_CONF_REG (0x007C)

31	28	27	26	18	17	9	8	0
(reserved)		PCR_I2S_RX_CLKM_DIV_YN1		PCR_I2S_RX_CLKM_DIV_X		PCR_I2S_RX_CLKM_DIV_Y		PCR_I2S_RX_CLKM_DIV_Z
0	0	0	0	0	1	0	Reset	

PCR_I2S_RX_CLKM_DIV_Z For $b \leq a/2$, the value of I2S_RX_CLKM_DIV_Z is b . For $b > a/2$, the value of I2S_RX_CLKM_DIV_Z is $(a - b)$.

(R/W)

PCR_I2S_RX_CLKM_DIV_Y For $b \leq a/2$, the value of I2S_RX_CLKM_DIV_Y is $(a\%b)$. For $b > a/2$, the value of I2S_RX_CLKM_DIV_Y is $(a\%(a - b))$.

(R/W)

PCR_I2S_RX_CLKM_DIV_X For $b \leq a/2$, the value of I2S_RX_CLKM_DIV_X is $\text{floor}(a/b) - 1$. For $b > a/2$, the value of I2S_RX_CLKM_DIV_X is $\text{floor}(a/(a-b)) - 1$.

(R/W)

PCR_I2S_RX_CLKM_DIV_YN1 For $b \leq a/2$, the value of I2S_RX_CLKM_DIV_YN1 is 0. For $b > a/2$, the value of I2S_RX_CLKM_DIV_YN1 is 1.

(R/W)

Note:

“a” and “b” represent the denominator and the numerator of fractional divider, respectively. For more information, see Section 29.6.

Register 8.32. PCR_SARADC_CLKM_CONF_REG (0x0084)

(reserved)										PCR_SARADC_CLKM_EN			PCR_SARADC_CLKM_SEL				PCR_SARADC_CLKM_DIV_NUM				PCR_SARADC_CLKM_DIV_B		PCR_SARADC_CLKM_DIV_A					
31									23	22	21	20	19					12	11			6	5					0
0 0 0 0 0 0 0 0 0 0										1	0	4				0		0				Reset						

PCR_SARADC_CLKM_DIV_A Configures the denominator of the frequency divider factor for SAR ADC function clock.

(R/W)

PCR_SARADC_CLKM_DIV_B Configures the numerator of the frequency divider factor for SAR ADC function clock.

(R/W)

PCR_SARADC_CLKM_DIV_NUM Configures the integral part of the frequency divider factor for SAR ADC function clock.

(R/W)

PCR_SARADC_CLKM_SEL Configures to select clock source.

0 (default): Select XTAL_CLK

1: Select PLL_F80M_CLK

2: Select RC_FAST_CLK

3: Reserved

(R/W)

PCR_SARADC_CLKM_EN Configures whether or not to enable SAR ADC function clock.

0: Not enable

1: Enable

(R/W)

Register 8.33. PCR_TSENS_CLK_CONF_REG (0x0088)

(reserved)							PCR_TSENS_RST_EN				(reserved)				(reserved)										
(reserved)							PCR_TSENS_CLK_EN				(reserved)				(reserved)										
(reserved)							PCR_TSENS_CLK_SEL				(reserved)				(reserved)										
31							24	23	22	21	20	19											0		
0							0				1				0										0

PCR_TSENS_CLK_SEL Configures to select clock source.

0 (default): Select RC_FAST_CLK

1: Select XTAL_CLK

(R/W)

PCR_TSENS_CLK_EN Configures whether or not to enable TSENS clock.

0: Not enable

1: Enable

(R/W)

PCR_TSENS_RST_EN Configures whether or not to reset TSENS module.

0: Not reset

1: Reset

(R/W)

Register 8.34. PCR_USB_SERIAL_JTAG_CONF_REG (0x008C)

(reserved)																												PCR_USB_SERIAL_JTAG_RST_EN			PCR_USB_SERIAL_JTAG_CLK_EN																													
(reserved)																												PCR_USB_SERIAL_JTAG_RST_EN			PCR_USB_SERIAL_JTAG_CLK_EN																													
31																											2	1	0																											0				
0																												0			1			0																										1

PCR_USB_SERIAL_JTAG_CLK_EN Configures whether or not to enable USB_SERIAL_JTAG clock.

0: Not enable

1: Enable

(R/W)

PCR_USB_SERIAL_JTAG_RST_EN Configures whether or not to reset USB_SERIAL_JTAG module.

0: Not reset

1: Reset

(R/W)

Register 8.37. PCR_ETM_CONF_REG (0x0098)

31	<i>(reserved)</i>																							2	1	0
0 0																							0	1	0	
																									1	

Reset

PCR_ETM_CLK_EN Configures whether or not to enable ETM clock.

0: Not enable

1: Enable

(R/W)

PCR_ETM_RST_EN Configures whether or not to reset ETM module.

0: Not reset

1: Reset

(R/W)

Register 8.38. PCR_PWM_CONF_REG (0x009C)

31	<i>(reserved)</i>																							2	1	0
0 0																							0	1	0	
																									1	

Reset

PCR_PWM_CLK_EN Configures whether or not to enable PWM clock.

0: Not enable

1: Enable

(R/W)

PCR_PWM_RST_EN Configures whether or not to reset PWM module.

0: Not reset

1: Reset

(R/W)

Register 8.39. PCR_PWM_CLK_CONF_REG (0x00A0)

(reserved)										PCR_PWM_CLKM_EN PCR_PWM_CLKM_SEL				PCR_PWM_DIV_NUM				(reserved)										
31									23	22	21	20	19					12	11									0
0 0 0 0 0 0 0 0 0 0										1	0	4				0 0 0 0 0 0 0 0 0 0 0 0 0 0 0 0 0 0								0				

PCR_PWM_DIV_NUM Configures the integral part of the frequency divider factor for PWM function clock.
(R/W)

PCR_PWM_CLKM_SEL Configures to select clock source.
 0 (default): Not select any clock
 1: Select PLL_F160M_CLK
 2: Select XTAL_CLK
 3: Select RC_FAST_CLK
 (R/W)

PCR_PWM_CLKM_EN Configures whether or not to activate PWM_CLKM.
 0: Not activate
 1: Activate
 (R/W)

Register 8.40. PCR_PARL_IO_CONF_REG (0x00A4)

(reserved)																												PCR_PARL_RST_EN PCR_PARL_CLK_EN		
31																											2	1	0	
0 0																												0	1	0

PCR_PARL_CLK_EN Configures whether or not to enable PARL APB clock.
 0: Not enable
 1: Enable
 (R/W)

PCR_PARL_RST_EN Configures whether or not to reset PARL APB register.
 0: Not reset
 1: Reset
 (R/W)

Register 8.41. PCR_PARL_CLK_RX_CONF_REG (0x00A8)

(reserved)										PCR_PARL_RX_RST_EN			PCR_PARL_CLK_RX_EN			PCR_PARL_CLK_RX_SEL			PCR_PARL_CLK_RX_DIV_NUM																		
31																				20	19	18	17	16	15												0
0										0										0	1	0	0							Reset							

PCR_PARL_CLK_RX_DIV_NUM Configures the integral part of the frequency divider factor for PARL RX clock.

(R/W)

PCR_PARL_CLK_RX_SEL Configures to select clock source.

0 (default): Select XTAL

1: Select PLL_F240M_CLK

2: Select RC_FAST_CLK

3: Use the clock from chip pin

(R/W)

PCR_PARL_CLK_RX_EN Configures whether or not to enable PARL RX clock.

0: Not enable

1: Enable

(R/W)

PCR_PARL_RX_RST_EN Configures whether or not to reset PARL RX module.

0: Not reset

1: Reset

(R/W)

Register 8.42. PCR_PARL_CLK_TX_CONF_REG (0x00AC)

(reserved)										PCR_PARL_TX_RST_EN			PCR_PARL_CLK_TX_EN			PCR_PARL_CLK_TX_SEL			PCR_PARL_CLK_TX_DIV_NUM													
31																			20	19	18	17	16	15								0
0										0										0			0							Reset		

PCR_PARL_CLK_TX_DIV_NUM Configures the integral part of the frequency divider factor for PARL TX clock.

(R/W)

PCR_PARL_CLK_TX_SEL Configures to select clock source.

0 (default): Select XTAL

1: Select PLL_F240M_CLK

2: Select RC_FAST_CLK

3: Use the clock from chip pin

(R/W)

PCR_PARL_CLK_TX_EN Configures whether or not to enable PARL TX clock.

0: Not enable

1: Enable

(R/W)

PCR_PARL_TX_RST_EN Configures whether or not to reset PARL TX module.

0: Not reset

1: Reset

(R/W)

Register 8.43. PCR_SDIO_SLAVE_CONF_REG (0x00B0)

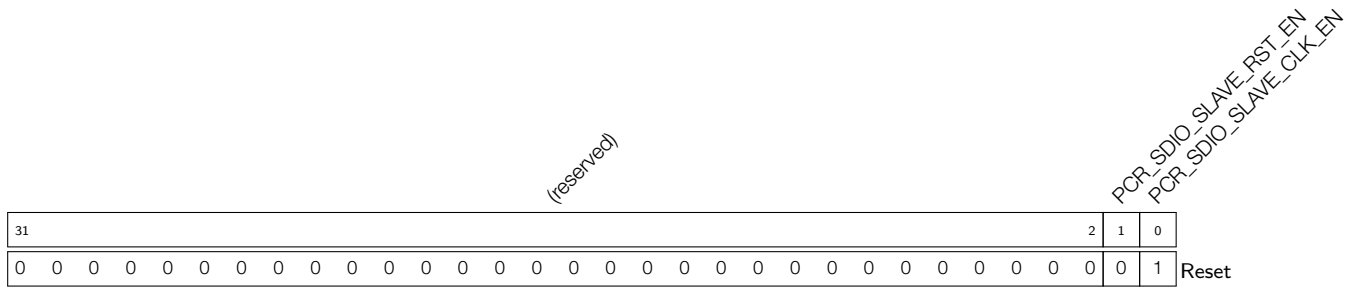

PCR_SDIO_SLAVE_CLK_EN Configures whether or not to enable SDIO slave clock.

0: Not enable

1: Enable

(R/W)

PCR_SDIO_SLAVE_RST_EN Configures whether or not to reset SDIO slave module.

0: Not reset

1: Reset

(R/W)

Register 8.44. PCR_GDMA_CONF_REG (0x00BC)

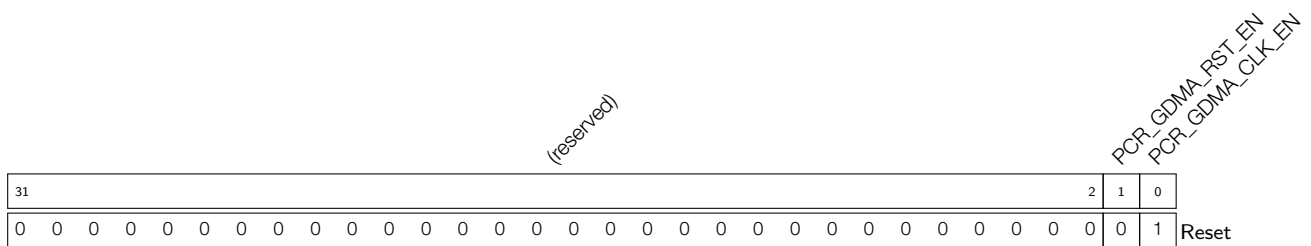

PCR_GDMA_CLK_EN Configures whether or not to enable GDMA clock.

0: Not enable

1: Enable

(R/W)

PCR_GDMA_RST_EN Configures whether or not to reset GDMA module.

0: Not reset

1: Reset

(R/W)

Register 8.45. PCR_SPI2_CONF_REG (0x00C0)

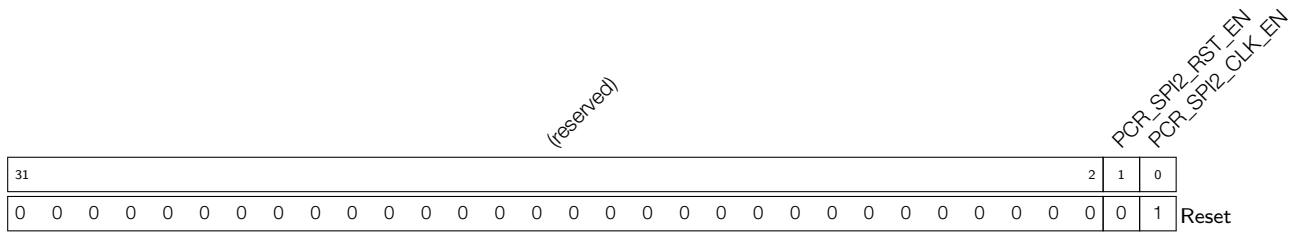

PCR_SPI2_CLK_EN Configures whether or not to enable SPI2 APB clock.
 0: Not enable
 1: Enable
 (R/W)

PCR_SPI2_RST_EN Configures whether or not to reset SPI2 module.
 0: Not reset
 1: Reset
 (R/W)

Register 8.46. PCR_SPI2_CLKM_CONF_REG (0x00C4)

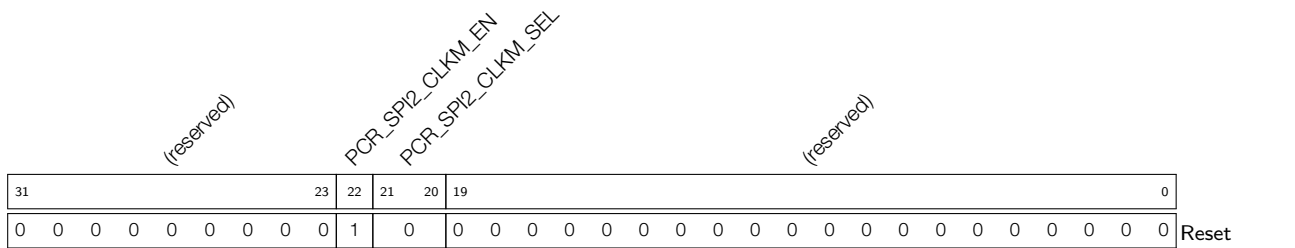

PCR_SPI2_CLKM_SEL Configures to select clock source.
 0 (default): Select XTAL_CLK
 1: Select PLL_F80M_CLK
 2: Select RC_FAST_CLK
 3: Reserved
 (R/W)

PCR_SPI2_CLKM_EN Configures whether or not to enable SPI2 function clock.
 0: Not enable
 1: Enable
 (R/W)

Register 8.49. PCR_RSA_CONF_REG (0x00D0)

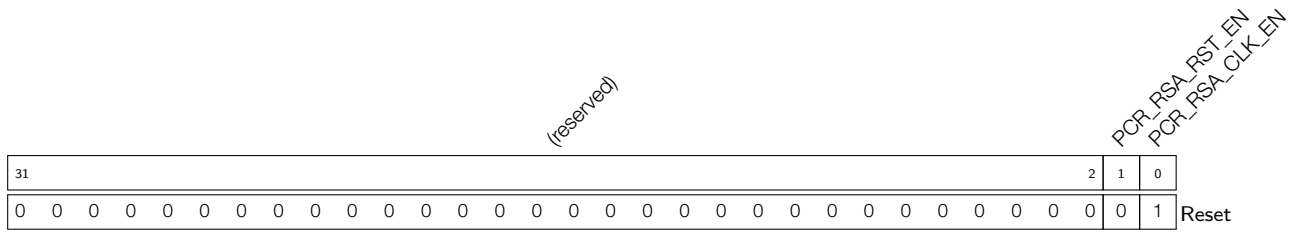

PCR_RSA_CLK_EN Configures whether or not to enable RSA clock.
 0: Not enable
 1: Enable
 (R/W)

PCR_RSA_RST_EN Configures whether or not to reset RSA module.
 0: Not reset
 1: Reset
 (R/W)

Register 8.50. PCR_RSA_PD_CTRL_REG (0x00D4)

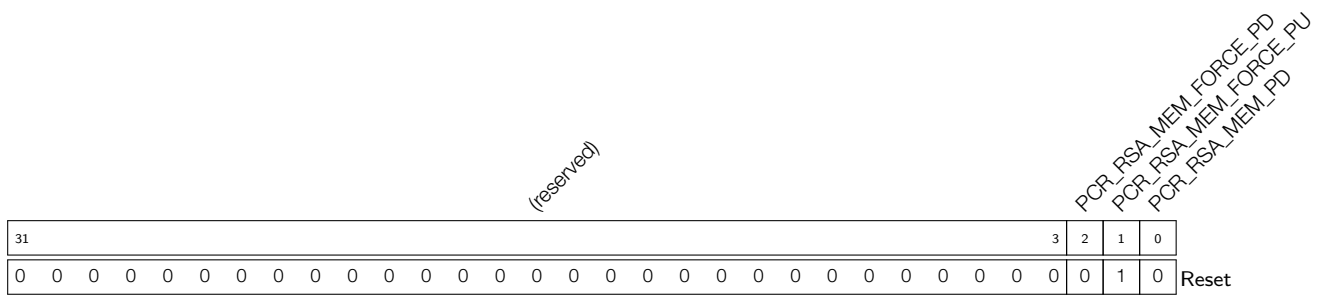

PCR_RSA_MEM_PD Configures whether or not to power down RSA internal memory.
 0: Not power down
 1: Power down
 (R/W)

PCR_RSA_MEM_FORCE_PU Configures whether or not to force power up RSA internal memory.
 0: Not force power up
 1: Force power up
 (R/W)

PCR_RSA_MEM_FORCE_PD Configures whether or not to force power down RSA internal memory.
 0: Not force power down
 1: Force power down
 (R/W)

Register 8.51. PCR_ECC_CONF_REG (0x00D8)

(reserved)																PCR_ECC_RST_EN		PCR_ECC_CLK_EN	
31															2	1	0		
0																0	1	0	Reset

PCR_ECC_CLK_EN Configures whether or not to enable ECC clock.

0: Not enable

1: Enable

(R/W)

PCR_ECC_RST_EN Configures whether or not to reset ECC module.

0: Not reset

1: Reset

(R/W)

Register 8.52. PCR_ECC_PD_CTRL_REG (0x00DC)

(reserved)																PCR_ECC_MEM_FORCE_PD		PCR_ECC_MEM_FORCE_PU	
31															3	2	1	0	
0																0	1	0	Reset

PCR_ECC_MEM_PD Configures whether or not to power down ECC internal memory.

0: Not power down

1: Power down

(R/W)

PCR_ECC_MEM_FORCE_PU Configures whether or not to force power up ECC internal memory.

0: Not force power up

1: Force power up

(R/W)

PCR_ECC_MEM_FORCE_PD Configures whether or not to force power down ECC internal memory.

0: Not force power down

1: Force power down

(R/W)

Register 8.53. PCR_DS_CONF_REG (0x00E0)

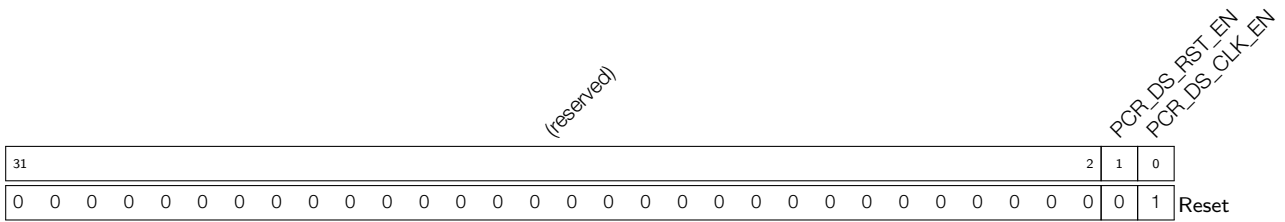

PCR_DS_CLK_EN Configures whether or not to enable DS clock.

0: Not enable

1: Enable

(R/W)

PCR_DS_RST_EN Configures whether or not to reset DS module.

0: Not reset

1: Reset

(R/W)

Register 8.54. PCR_HMAC_CONF_REG (0x00E4)

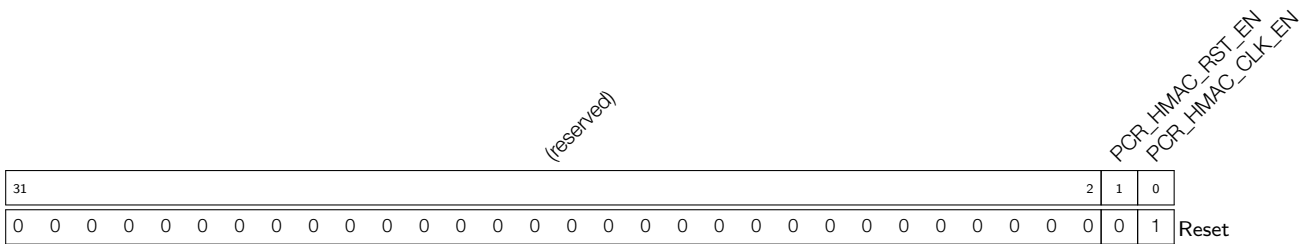

PCR_HMAC_CLK_EN Configures whether or not to enable HMAC clock.

0: Not enable

1: Enable

(R/W)

PCR_HMAC_RST_EN Configures whether or not to reset HMAC module.

0: Not reset

1: Reset

(R/W)

Register 8.55. PCR_IOMUX_CONF_REG (0x00E8)

(reserved)																												PCR_IOMUX_RST_EN		PCR_IOMUX_CLK_EN	
31																											2	1	0		
0																												0	1	0	

Reset

PCR_IOMUX_CLK_EN Configures whether or not to enable IO MUX APB clock.

0: Not enable

1: Enable

(R/W)

PCR_IOMUX_RST_EN Configures whether or not to reset IO MUX module.

0: Not reset

1: Reset

(R/W)

Register 8.56. PCR_IOMUX_CLK_CONF_REG (0x00EC)

(reserved)																							PCR_IOMUX_FUNC_CLK_EN				PCR_IOMUX_FUNC_CLK_SEL				(reserved)										
31																							23	22	21	20	19														0
0																							1	3	0										0						

Reset

PCR_IOMUX_FUNC_CLK_SEL Configures to select clock source.

0: Not select any clock

1: Select PLL_F80M_CLK

2: Select RC_FAST_CLK

3: XTAL_CLK

(R/W)

PCR_IOMUX_FUNC_CLK_EN Configures whether or not to enable IO MUX function clock.

0: Not enable

1: Enable

(R/W)

Register 8.57. PCR_MEM_MONITOR_CONF_REG (0x00F0)

(reserved)																												PCR_MEM_MONITOR_RST_EN		PCR_MEM_MONITOR_CLK_EN							
31																											2	1	0								
0	0	0	0	0	0	0	0	0	0	0	0	0	0	0	0	0	0	0	0	0	0	0	0	0	0	0	0	0	0	0	0	0	0	0	0	1	Reset

PCR_MEM_MONITOR_CLK_EN Configures whether or not to enable MEM_MONITOR clock.

- 0: Not enable
- 1: Enable
- (R/W)

PCR_MEM_MONITOR_RST_EN Configures whether or not to reset MEM_MONITOR module.

- 0: Not reset
- 1: Reset
- (R/W)

Register 8.58. PCR_TRACE_CONF_REG (0x00FC)

(reserved)																												PCR_TRACE_RST_EN		PCR_TRACE_CLK_EN							
31																											2	1	0								
0	0	0	0	0	0	0	0	0	0	0	0	0	0	0	0	0	0	0	0	0	0	0	0	0	0	0	0	0	0	0	0	0	0	0	0	1	Reset

PCR_TRACE_CLK_EN Configures whether or not to enable TRACE clock.

- 0: Not enable
- 1: Enable
- (R/W)

PCR_TRACE_RST_EN Configures whether or not to reset TRACE module.

- 0: Not reset
- 1: Reset
- (R/W)

Register 8.59. PCR_ASSIST_CONF_REG (0x0100)

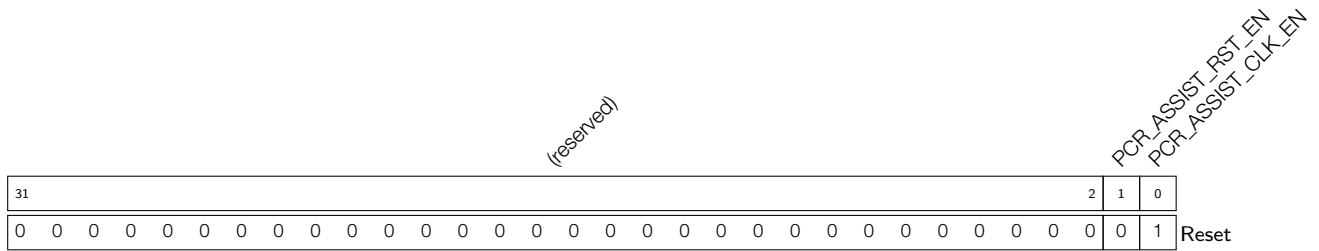

PCR_ASSIST_CLK_EN Configures whether or not to enable ASSIST clock.
 0: Not enable
 1: Enable
 (R/W)

PCR_ASSIST_RST_EN Configures whether or not to reset ASSIST module.
 0: Not reset
 1: Reset
 (R/W)

Register 8.60. PCR_CACHE_CONF_REG (0x0104)

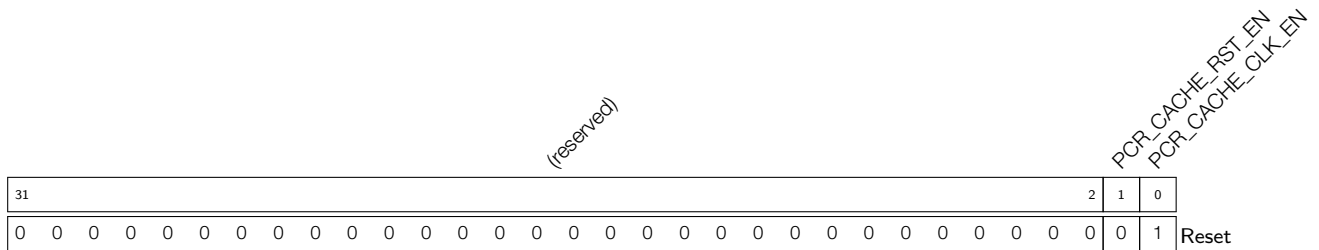

PCR_CACHE_CLK_EN Configures whether or not to enable CACHE clock.
 0: Not enable
 1: Enable
 (R/W)

PCR_CACHE_RST_EN Configures whether or not to reset CACHE module.
 0: Not reset
 1: Reset
 (R/W)

Register 8.61. PCR_MODEM_APB_CONF_REG (0x0108)

31	<i>(reserved)</i>																												2	1	0	
<i>(reserved)</i>																														<i>PCR_MODEM_RST_EN</i>		
<i>(reserved)</i>																														<i>PCR_MODEM_APB_CLK_EN</i>		
0 0																														0	1	0
Reset																																

PCR_MODEM_APB_CLK_EN Configures whether or not to enable MODEM_APB clock.

0: Disable

1: Enable

(R/W)

PCR_MODEM_RST_EN Configures whether or not to reset modem subsystem.

0: Not reset

1: Reset

(R/W)

Register 8.62. PCR_TIMEOUT_CONF_REG (0x010C)

31	<i>(reserved)</i>																												3	2	1	0
<i>(reserved)</i>																														<i>PCR_HP_TIMEOUT_RST_EN</i>		
<i>(reserved)</i>																														<i>PCR_CPU_TIMEOUT_RST_EN</i>		
<i>(reserved)</i>																														<i>(reserved)</i>		
0 0																														0	0	0
Reset																																

PCR_CPU_TIMEOUT_RST_EN Configures whether or not to reset CPU_PERI TIMEOUT module.

0: Not reset

1: Reset

(R/W)

PCR_HP_TIMEOUT_RST_EN Configures whether or not to reset HP_PERI TIMEOUT module and HP_MODEM TIMEOUT module.

0: Not reset

1: Reset

(R/W)

Register 8.63. PCR_SYSCLK_CONF_REG (0x0110)

(reserved)		PCR_CLK_XTAL_FREQ		(reserved)				PCR_SOC_CLK_SEL				PCR_HS_DIV_NUM		PCR_LS_DIV_NUM	
31	30	24	23	18	17	16	15	8	7			0			
0		40		0	0	0	0	0	0	2		0		Reset	

PCR_LS_DIV_NUM Represents HP_ROOT_CLK is derived from a low-speed clock source (such as XTAL/FOSC) divided by 1.
(HRO)

PCR_HS_DIV_NUM Represents HP_ROOT_CLK is derived from a high-speed clock source (such as SPLL) divided by 3.
(HRO)

PCR_SOC_CLK_SEL Configures to select clock source.
0: Select XTAL_CLK
1: Select PLL_CLK
2: Select RC_FAST_CLK
3: Reserved
(R/W)

PCR_CLK_XTAL_FREQ Represents the frequency of XTAL.
Measurement unit: MHz
(RO)

Register 8.64. PCR_CPU_WAITI_CONF_REG (0x0114)

(reserved)	PCR_CPU_WAITI_DELAY_NUM	PCR_CPU_WAIT_MODE_FORCE_ON	(reserved)
31	8	7	4 3 2 0
0 0	0	1	0 0 0
Reset			

PCR_CPU_WAIT_MODE_FORCE_ON Configures whether or not to force enable cpu_waiti_clk.

0: Not force enable

1: Force enable

(R/W)

PCR_CPU_WAITI_DELAY_NUM Configures delay cycle when CPU enters WAITI mode.

After delay, waiti_clk will close.

(R/W)

Register 8.65. PCR_CPU_FREQ_CONF_REG (0x0118)

(reserved)																	PCR_CPU_HS_120M_FORCE			PCR_CPU_HS_DIV_NUM			PCR_CPU_LS_DIV_NUM				
31																		17	16	15				8	7		0
0																	0			0			0			Reset	

PCR_CPU_LS_DIV_NUM Configures the divider of HP_ROOT_CLK to generate CPU_CLK.

0 (default): The HP_ROOT_CLK is divided by 1 to generate CPU_CLK

1: The HP_ROOT_CLK is divided by 2 to generate CPU_CLK

3: The HP_ROOT_CLK is divided by 4 to generate CPU_CLK

This field is only available when a low-speed clock source such as XTAL/FOSC is selected, and should be used together with PCR_AHB_LS_DIV_NUM.

(R/W)

PCR_CPU_HS_DIV_NUM Configures the divider of HP_ROOT_CLK to generate CPU_CLK.

0 (default): The HP_ROOT_CLK is divided by 1 to generate CPU_CLK

1: The HP_ROOT_CLK is divided by 2 to generate CPU_CLK

3: The HP_ROOT_CLK is divided by 4 to generate CPU_CLK

This field is only available when a high-speed clock source such as SPILL is selected, and should be used together with PCR_AHB_HS_DIV_NUM.

(R/W)

PCR_CPU_HS_120M_FORCE Configures whether or not to force CPU_CLK at 120 MHz when PCR_CPU_HS_DIV_NUM is 0.

0: Not force CPU_CLK at 120 MHz

1: Force CPU_CLK at 120 MHz

This bit is only available when PCR_CPU_HS_DIV_NUM is 0 and CPU_CLK is derived from SPILL.

(R/W)

Register 8.66. PCR_AHB_FREQ_CONF_REG (0x011C)

(reserved)																PCR_AHB_HS_DIV_NUM								PCR_AHB_LS_DIV_NUM									
31																16	15								8	7							0
0																3								0								Reset	

PCR_AHB_LS_DIV_NUM Configures the divider of HP_ROOT_CLK to generate AHB_CLK.

0 (default): HP_ROOT_CLK is divided by 1 to generate AHB_CLK

1: HP_ROOT_CLK is divided by 2 to generate AHB_CLK

3: HP_ROOT_CLK is divided by 4 to generate AHB_CLK

7: HP_ROOT_CLK is divided by 8 to generate AHB_CLK

This field is only available when a low-speed clock source such as XTAL/FOSC is selected, and should be used together with PCR_CPU_LS_DIV_NUM.

(R/W)

PCR_AHB_HS_DIV_NUM Configure the divider of HP_ROOT_CLK to generate AHB_CLK.

3 (default): HP_ROOT_CLK is divided by 4 to generate AHB_CLK

7: HP_ROOT_CLK is divided by 8 to generate AHB_CLK

15: HP_ROOT_CLK is divided by 16 to generate AHB_CLK

This field is only available when a high-speed clock source such as SPILL is selected, and should be used together with PCR_CPU_HS_DIV_NUM.

(R/W)

Register 8.67. PCR_APB_FREQ_CONF_REG (0x0120)

31	(reserved)	16	15	8	7	0	
0	0	0	0	0	0	0	0
				PCR_APB_DIV_NUM		PCR_APB_DECREASE_DIV_NUM	
				0		0	
							Reset

PCR_APB_DECREASE_DIV_NUM Configures the divider of APB_CLK to generate APB_DECREASE_CLK.

- 0: APB_CLK is divided by 1 to generate APB_DECREASE_CLK
- 1: APB_CLK is divided by 2 to generate APB_DECREASE_CLK
- 3 (default): APB_CLK is divided by 4 to generate APB_DECREASE_CLK

If the value of this field is greater than PCR_APB_DIV_NUM, APB_CLK will be automatically down to APB_DECREASE_CLK only when no access is on APB bus, and will recover to the previous frequency when a new access appears on APB bus. Note that enabling this function will reduce performance. Users can set this field as zero to disable the auto-decrease-APB-freq function. By default, this function is disabled.

(R/W)

PCR_APB_DIV_NUM Configures the divider of AHB_CLK to generate APB_CLK.

- 0 (default): AHB_CLK is divided by 1 to generate APB_CLK
- 1: AHB_CLK is divided by 2 to generate APB_CLK
- 3: AHB_CLK is divided by 4 to generate APB_CLK

(R/W)

Register 8.68. PCR_PLL_DIV_CLK_EN_REG (0x0128)

(reserved)														<div style="display: flex; justify-content: space-between;"> <div style="text-align: right;">31</div> <div style="text-align: left;">7 6 5 4 3 2 1 0</div> </div>								
0 0														1	1	1	1	1	1	1	1	Reset

PCR_PLL_240M_CLK_EN Configures whether or not to enable 240 MHz clock derived from SPPLL divided by 2.
 0: Not enable
 1 (default): Enable
 Only available when high-speed clock source SPPLL is active.
 (R/W)

PCR_PLL_160M_CLK_EN Configures whether or not to enable 160 MHz clock derived from SPPLL divided by 3.
 0: Not enable
 1 (default): Enable
 Only available when high-speed clock source SPPLL is active.
 (R/W)

PCR_PLL_120M_CLK_EN Configures whether or not to enable 120 MHz clock derived from SPPLL divided by 4.
 0: Not enable
 1 (default): Enable
 Only available when high-speed clock source SPPLL is active.
 (R/W)

PCR_PLL_80M_CLK_EN Configures whether or not to enable 80 MHz clock derived from SPPLL divided by 6.
 0: Not enable
 1 (default): Enable
 Only available when high-speed clock source SPPLL is active.
 (R/W)

PCR_PLL_48M_CLK_EN Configures whether or not to enable 48 MHz clock derived from SPPLL divided by 10.
 0: Not enable
 1 (default): Enable
 Only available when high-speed clock source SPPLL is active.
 (R/W)

Continued on the next page...

Register 8.68. PCR_PLL_DIV_CLK_EN_REG (0x0128)

Continued from the previous page...

PCR_PLL_40M_CLK_EN Configures whether or not to enable 40 MHz clock derived from SPLL divided by 12.
 0: Not enable
 1 (default): Enable
 Only available when high-speed clock source SPLL is active.
 (R/W)

PCR_PLL_20M_CLK_EN Configures whether or not to enable 20 MHz clock derived from SPLL divided by 24.
 0: Not enable
 1 (default): Enable
 Only available when high-speed clock source SPLL is active.
 (R/W)

Register 8.69. PCR_CTRL_32K_CONF_REG (0x0134)

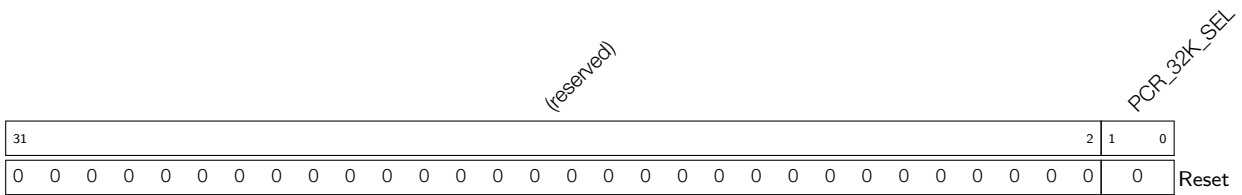

PCR_32K_SEL Configures to select one 32 kHz clock for MODEM_SYSTEM and TIMER_GROUP.
 0: Select RC32K_CLK (default)
 1: Select XTAL32K_CLK
 2/3: Select OSC_SLOW_CLK from GPIO0
 (R/W)

Register 8.70. PCR_SRAM_POWER_CONF_REG (0x0138)

(reserved)										PCR_ROM_CLKGATE_FORCE_ON		PCR_ROM_FORCE_PD		PCR_ROM_FORCE_PU		PCR_SRAM_CLKGATE_FORCE_ON		PCR_SRAM_FORCE_PD		PCR_SRAM_FORCE_PU						
31										21	20	18	17	15	14	12	11			8	7			4	3	0
0 0 0 0 0 0 0 0 0 0										0x0		0x0		0x7		0x0		0x0		0xf		Reset				

PCR_SRAM_FORCE_PU Configures whether or not to force power up SRAM.

0: Not force power up

1: Force power up

(R/W)

PCR_SRAM_FORCE_PD Configures whether or not to force power down SRAM.

0: Not force power down

1: Force power down

(R/W)

PCR_SRAM_CLKGATE_FORCE_ON Configures whether or not to force open the clock and bypass the gate-clock when accessing the SRAM.

0: A gate-clock will be used when accessing the SRAM.

1: Force to open the clock and bypass the gate-clock when accessing the SRAM.

(R/W)

PCR_ROM_FORCE_PU Configures whether or not to force power up ROM.

0: Not force power up

1: Force power up

(R/W)

PCR_ROM_FORCE_PD Configures whether or not to force power down ROM.

0: Not force power down

1: Force power down

(R/W)

PCR_ROM_CLKGATE_FORCE_ON Configures whether or not to force open the clock and bypass the gate-clock when accessing the ROM.

0: A gate-clock will be used when accessing the ROM.

1: Force to open the clock and bypass the gate-clock when accessing the ROM.

(R/W)

Register 8.71. PCR_RESET_EVENT_BYPASS_REG (0x0FF0)

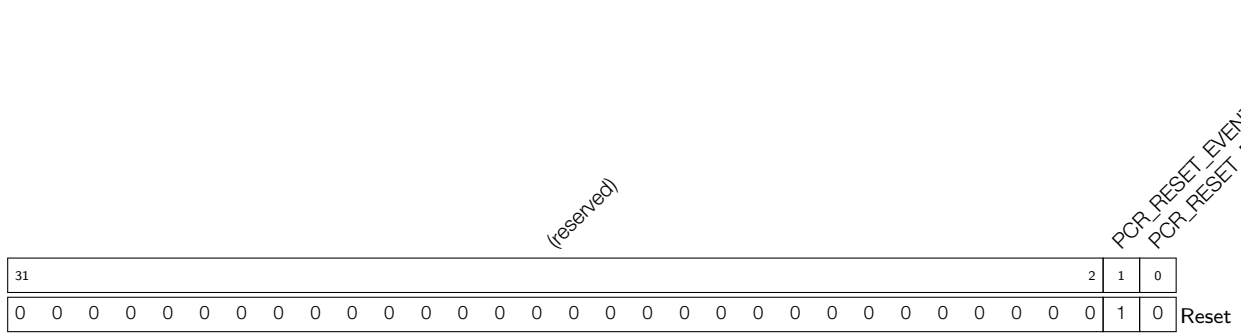

PCR_RESET_EVENT_BYPASS_APM Configures to control reset event relationship for tee_reg/apm_reg/hp_system_reg.

0: tee_reg/apm_reg/hp_system_reg will not only be reset by power-reset, but also some reset events.

1: tee_reg/apm_reg/hp_system_reg will only be reset by power-reset. Some reset events will be bypassed.

(R/W)

PCR_RESET_EVENT_BYPASS Configures to control reset event relationship for system-bus.

0: System bus (including arbiter/router) will not only be reset by power-reset, but also some reset events.

1: System bus (including arbiter/router) will only be reset by power-reset. Some reset events will be bypassed.

(R/W)

Register 8.72. PCR_SYSCCLK_FREQ_QUERY_0_REG (0x0124)

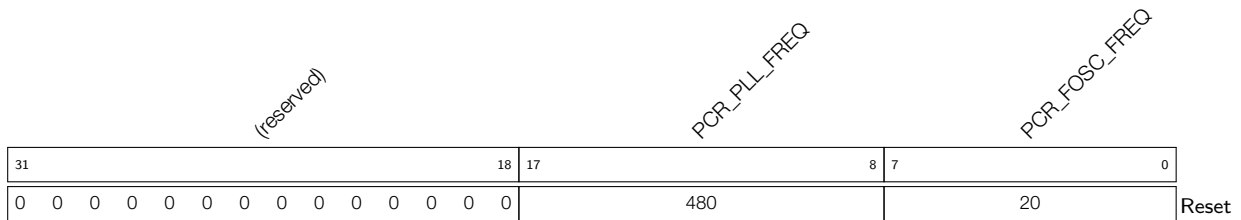

PCR_FOSC_FREQ Represents the frequency of RC_FAST_CLK.

Measurement unit: MHz

(HRO)

PCR_PLL_FREQ Represents the frequency of PLL_CLK.

Measurement unit: MHz

(HRO)

Register 8.73. PCR_DATE_REG (0x0FFC)

(reserved)				PCR_DATE																				0
31	28	27																					0	
0	0	0	0	0x2206150																				Reset

PCR_DATE Version control register.
(R/W)

8.5.2 LP Registers

The addresses of the last two registers in this section are relative to the Low-power Always-on Register (LP_AON) base address. The other addresses in this section are relative to the Low-power Clock/Reset Register (LP_CLKRST) base address. For base address, please refer to Table 5-2 in Chapter 5 *System and Memory*.

Register 8.74. LP_CLKRST_LP_CLK_CONF_REG (0x0000)

(reserved)																												LP_CLKRST_FAST_CLK_SEL				LP_CLKRST_SLOW_CLK_SEL				Reset
31																											3	2	1	0					0	
0	0	0	0	0	0	0	0	0	0	0	0	0	0	0	0	0	0	0	0	0	0	0	0	0	0	0	0	0	0	0	0	1	0x0	Reset		

LP_CLKRST_SLOW_CLK_SEL Configures the source of LP_SLOW_CLK.

- 0: RC_SLOW_CLK
 - 1: XTAL32K_CLK
 - 2: RC32K_CLK
 - 3: OSC_SLOW_CLK
- (R/W)

LP_CLKRST_FAST_CLK_SEL configures the source of LP_FAST_CLK.

- 0: RC_FAST_CLK
 - 1: XTAL_D2_CLK
- (R/W)

Register 8.75. LP_CLKRST_LP_CLK_PO_EN_REG (0x0004)

(reserved)																LP_CLKRST_LPBUS_OEN	LP_CLKRST_RING_OEN	LP_CLKRST_FAST_OEN	LP_CLKRST_SLOW_OEN	LP_CLKRST_CORE_OEN	LP_CLKRST_XTAL32K_OEN	LP_CLKRST_OSC32K_OEN	LP_CLKRST_FOSC_OEN	LP_CLKRST_SOSC_OEN	LP_CLKRST_AON_OEN	LP_CLKRST_AON_FAST_OEN	LP_CLKRST_AON_SLOW_OEN						
31	30	29	28	27	26	25	24	23	22	21	20	19	18	17	16	15	14	13	12	11	10	9	8	7	6	5	4	3	2	1	0		
0	0	0	0	0	0	0	0	0	0	0	0	0	0	0	0	0	0	0	0	0	1	1	1	1	1	1	1	1	1	1	1	1	0

Reset

LP_CLKRST_AON_SLOW_OEN Configures the clock gate to pad of the LP_DYN_SLOW_CLK.

0: Disable the clk pass clock gate

1: Enable the clk pass clock gate

(R/W)

LP_CLKRST_AON_FAST_OEN Configures the clock gate to pad of the LP_DYN_FAST_CLK.

0: Disable the clk pass clock gate

1: Enable the clk pass clock gate

(R/W)

LP_CLKRST_SOSC_OEN Configures the clock gate to pad of the OSC_SLOW_CLK.

0: Disable the clk pass clock gate

1: Enable the clk pass clock gate

(R/W)

LP_CLKRST_FOSC_OEN Configures the clock gate to pad of the RC_FAST_CLK.

0: Disable the clk pass clock gate

1: Enable the clk pass clock gate

(R/W)

LP_CLKRST_OSC32K_OEN Configures the clock gate to pad of the RC32K_CLK.

0: Disable the clk pass clock gate

1: Enable the clk pass clock gate

(R/W)

LP_CLKRST_XTAL32K_OEN Configures the clock gate to pad of the XTAL32K_CLK.

0: Disable the clk pass clock gate

1: Enable the clk pass clock gate

(R/W)

Continued on the next page...

Register 8.75. LP_CLKRST_LP_CLK_PO_EN_REG (0x0004)

Continued from the previous page...

LP_CLKRST_CORE_EFUSE_OEN Configures the clock gate to pad of the EFUSE_CTRL clock.

0: Disable the clk pass clock gate

1: Enable the clk pass clock gate

(R/W)

LP_CLKRST_SLOW_OEN Configures the clock gate to pad of the LP_SLOW_CLK.

0: Disable the clk pass clock gate

1: Enable the clk pass clock gate

(R/W)

LP_CLKRST_FAST_OEN Configures the clock gate to pad of the LP_FAST_CLK.

0: Disable the clk pass clock gate

1: Enable the clk pass clock gate

(R/W)

LP_CLKRST_RNG_OEN Configures the clock gate to pad of the RNG clk.

0: Disable the clk pass clock gate

1: Enable the clk pass clock gate

(R/W)

LP_CLKRST_LPBUS_OEN Configures the clock gate to pad of the LP bus clk.

0: Disable the clk pass clock gate

1: Enable the clk pass clock gate

(R/W)

Register 8.76. LP_CLKRST_LP_CLK_EN_REG (0x0008)

LP_CLKRST_FAST_ORI_GATE

(reserved)

31	30																												0
0																												Reset	

LP_CLKRST_FAST_ORI_GATE Configures the clock gate to LP_FAST_CLK

0: Invalid. The clock gate controlled by hardware fsm

1: Force the clk pass clock gate

(R/W)

Register 8.77. LP_CLKRST_LP_RST_EN_REG (0x000C)

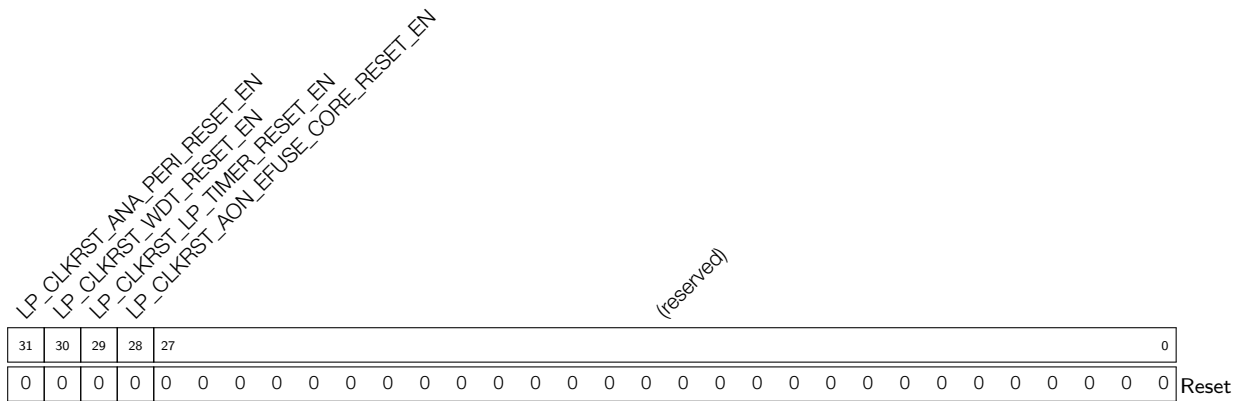

LP_CLKRST_AON_EFUSE_CORE_RESET_EN Configures whether or not to reset EFUSE_CTRL always-on part
 0: Invalid.No effect
 1: Reset
 (R/W)

LP_CLKRST_LP_TIMER_RESET_EN Configures whether or not to reset LP_TIMER
 0: Invalid.No effect
 1: Reset
 (R/W)

LP_CLKRST_WDT_RESET_EN Configures whether or not to reset LP_WDT and super watch dog
 0: Invalid.No effect
 1: Reset
 (R/W)

LP_CLKRST_ANA_PERI_RESET_EN Configures whether or not to reset analog peri, include brownout controller
 0: Invalid.No effect
 1: Reset
 (R/W)

Register 8.78. LP_CLKRST_RESET_CAUSE_REG (0x0010)

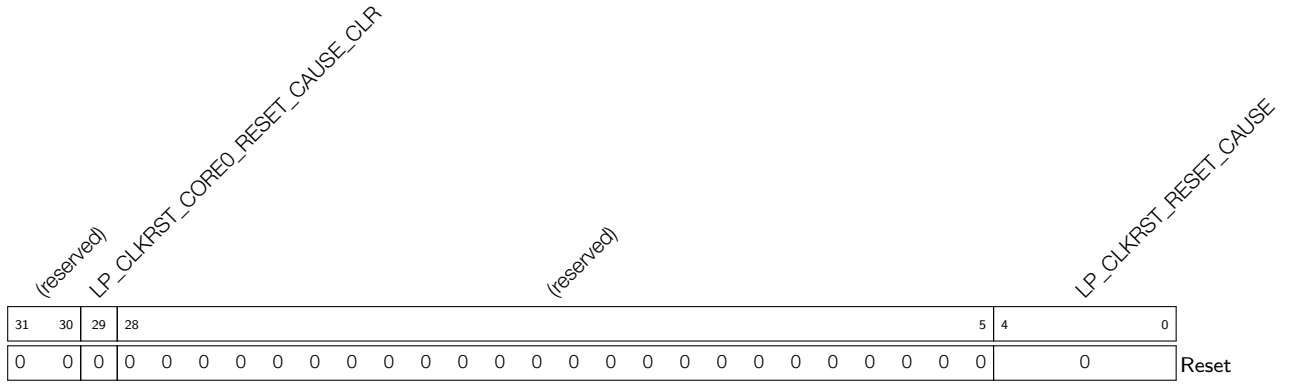

LP_CLKRST_RESET_CAUSE Represents the reset cause.
(RO)

LP_CLKRST_CORE0_RESET_CAUSE_CLR Configures whether or not to trigger the reset cause to 0x0
0: Invalid. No effect
1: Trigger the reset cause to 0x0
(WT)

Register 8.79. LP_CLKRST_CPU_RESET_REG (0x0014)

LP_CLKRST_CPU_STALL_EN		LP_CLKRST_CPU_STALL_WAIT		LP_CLKRST_RTC_WDT_CPU_RESET_EN		LP_CLKRST_RTC_WDT_CPU_RESET_LENGTH		(reserved)	
31	30	26	25	24	22	21			
0	1	0	1	0 0			0	Reset	

LP_CLKRST_RTC_WDT_CPU_RESET_LENGTH configures the reset length of LP_WDT reset CPU
 Measurement unit: LP_DYN_FAST_CLK
 (R/W)

LP_CLKRST_RTC_WDT_CPU_RESET_EN Configures whether or not LP_WDT can reset CPU
 0: LP_WDT could not reset CPU when LP_WDT timeout
 1: LP_WDT could reset CPU when LP_WDT timeout
 (R/W)

LP_CLKRST_CPU_STALL_WAIT configure the time between CPU stall and reset
 Measurement unit: LP_DYN_FAST_CLK
 (R/W)

LP_CLKRST_CPU_STALL_EN Configures whether or not CPU entry stall state before LP_WDT and software reset CPU
 0: CPU will not entry stall state before LP_WDT and software reset CPU
 1: CPU will entry stall state before LP_WDT and software reset CPU
 (R/W)

Register 8.80. LP_CLKRST_FOSC_CNTL_REG (0x0018)

LP_CLKRST_FOSC_DFREQ		(reserved)	
31	22	21	0
0xac		0 0	
			Reset

LP_CLKRST_FOSC_DFREQ Configures the RC_FAST_CLK frequency, the clock frequency will increase with this field.
 (R/W)

Register 8.81. LP_CLKRST_RC32K_CNTL_REG (0x001C)

<i>LP_CLKRST_RC32K_DFREQ</i>		<i>(reserved)</i>																		
31	22	21																		0
0xac																	0		Reset	

LP_CLKRST_RC32K_DFREQ Configures the RC32K_CLK frequency, the clock frequency will increase with this field.
(R/W)

Register 8.82. LP_CLKRST_CLK_TO_HP_REG (0x0020)

<i>LP_CLKRST_ICG_HP_FOSC</i>					<i>(reserved)</i>																		
<i>LP_CLKRST_ICG_HP_OSC32K</i>																							
<i>LP_CLKRST_ICG_HP_SOSC</i>																							
<i>LP_CLKRST_ICG_HP_XTAL32K</i>																							
31	30	29	28	27																		0	
1	1	1	1	0																		0	Reset

LP_CLKRST_ICG_HP_XTAL32K Configures the clk gate of XTAL32K_CLK to HP system
 0: The clk could not pass to HP system
 1: The clk could pass to HP system
 (R/W)

LP_CLKRST_ICG_HP_SOSC Configures the clk gate of RC_SLOW_CLK to HP system
 0: The clk could not pass to HP system
 1: The clk could pass to HP system
 (R/W)

LP_CLKRST_ICG_HP_OSC32K Configures the clk gate of RC32K_CLK to HP system
 0: The clk could not pass to HP system
 1: The clk could pass to HP system
 (R/W)

LP_CLKRST_ICG_HP_FOSC Configures the clk gate of RC_FAST_CLK to HP system
 0: The clk could not pass to HP system
 1: The clk could pass to HP system
 (R/W)

Register 8.85. LP_CLKRST_XTAL32K_REG (0x002C)

<i>LP_CLKRST_DAC_XTAL32K</i>												<i>LP_CLKRST_DBUF_XTAL32K</i>												<i>LP_CLKRST_DGM_XTAL32K</i>												<i>LP_CLKRST_DRES_XTAL32K</i>												<i>(reserved)</i>											
31	29	28	27	25	24	22	21																																													0							
3	0		3			3			0	0	0	0	0	0	0	0	0	0	0	0	0	0	0	0	0	0	0	0	0	0	0	0	0	0	0	0	0	0	0	0	Reset																		

LP_CLKRST_DRES_XTAL32K Configures DRES.
(R/W)

LP_CLKRST_DGM_XTAL32K Configures DGM.
(R/W)

LP_CLKRST_DBUF_XTAL32K Configures DBUF.
(R/W)

LP_CLKRST_DAC_XTAL32K Configures DAC.
(R/W)

Register 8.86. LP_CLKRST_DATE_REG (0x03FC)

<i>(reserved)</i>												<i>LP_CLKRST_CLKRST_DATE</i>											
31	30																						0
0												0x2206090											Reset

LP_CLKRST_CLKRST_DATE Version control register.
(R/W)

Register 8.87. LP_AON_SYS_CFG_REG (0x0034)

LP_AON_HPSYS_SW_RESET

(reserved)

31	30																													0						
0	0	0	0	0	0	0	0	0	0	0	0	0	0	0	0	0	0	0	0	0	0	0	0	0	0	0	0	0	0	0	0	0	0	0	0	0

Reset

LP_AON_HPSYS_SW_RESET Software system reset.
(WT)

Register 8.88. LP_AON_CPUCORE0_CFG_REG (0x0038)

LP_AON_CPU_CORE0_SW_RESET

(reserved)

31	29	28	27																										0								
0	0	0	0	0	0	0	0	0	0	0	0	0	0	0	0	0	0	0	0	0	0	0	0	0	0	0	0	0	0	0	0	0	0	0	0	0	0

Reset

LP_AON_CPU_CORE0_SW_RESET Software CPU reset.
(WT)

9 Chip Boot Control

9.1 Overview

Chip boot process and some chip functions are determined on power-on or hardware reset using strapping pins and eFuses. The following functionality can be determined:

- chip boot mode
- enable or disable of ROM messages printing to UART0
- source of JTAG signals
- SDIO input sampling edge and output driving edge

ESP32-C6 has five strapping pins:

- MTMS
- MTDI
- GPIO8
- GPIO9
- GPIO15

During power-on reset, and brownout reset (see Chapter 8 *Reset and Clock*), hardware captures samples and stores the voltage level of strapping pins as strapping bit of “0” or “1” in latches, and holds these bits until the chip is powered down or the next chip reset. Software can read the latch status (strapping value) from [GPIO_STRAPPING](#).

9.2 Functional Description

This section provides description of the chip functions and the patterns of the strapping pins and eFuse values to invoke each function.

Notice:

Only documented patterns should be used. If an undocumented pattern is used, it may trigger unexpected behaviors.

9.2.1 Default Configuration

By default, GPIO9 is connected to the chip’s internal pull-up resistor. If GPIO9 is not connected or is connected to an external high-impedance circuit, the internal weak pull-up determines the default input level of this strapping pin (see Table 9-1).

Table 9-1. Default Configuration of Strapping Pins

Strapping Pin	Default Configuration
MTMS	Floating
MTDI	Floating
GPIO8	Floating
GPIO9	Pull-up
GPIO15	Floating

To change the strapping bit values, users can apply external pull-down/pull-up resistors, or use host MCU GPIOs to control the voltage level of these pins when powering on ESP32-C6. After the reset is released, the strapping pins work as normal-function pins.

9.2.2 Boot Mode Control

The values of GPIO8 and GPIO9 at reset determine the boot mode after the reset is released. Table 9-2 shows the strapping pin values of GPIO8 and GPIO9, and the associated boot modes.

Table 9-2. Boot Mode Control

Boot Mode	GPIO8	GPIO9
SPI Boot	x	1
Download Boot	1	0

* x: this value is ignored.

In SPI Boot mode, the ROM bootloader loads and executes the program from SPI flash to boot the system. SPI Boot mode can be further classified as follows:

- Normal Flash Boot: supports Secure Boot. The ROM bootloader loads the program from flash into SRAM and executes it. In most practical scenarios, this program is the 2nd stage bootloader, which later boots the target application.
- Direct Boot: does not support Secure Boot and programs run directly from flash. To enable this mode, make sure that the first two words of the bin file downloaded to flash are 0xaedb041d. For more detailed process, see Figure 9-1.

In Download Boot mode, users can download code into flash using UART0 or USB interface. It is also possible to load a program into SRAM and execute it from SRAM.

Figure 9-1 shows the detailed boot flow of the chip.

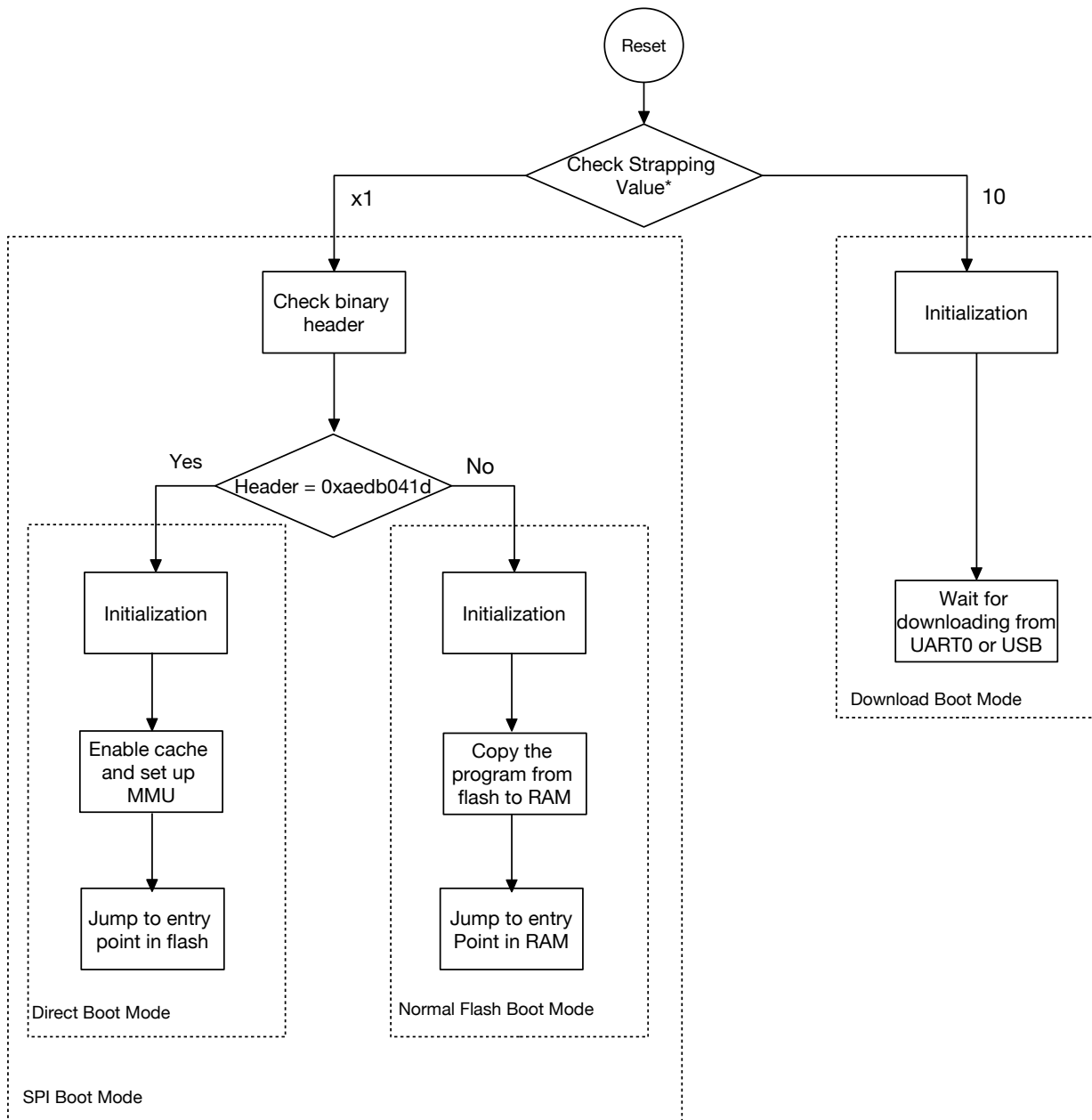

***Note:** The strapping values "x1" and "10" are the combination of GPIO8 and GPIO9 pins, see Table 9-2.

Figure 9-1. Chip Boot Flow

The following eFuses allows controlling boot mode behaviors:

- [EFUSE_DIS_FORCE_DOWNLOAD](#)

If this eFuse is 0 (default), software can force switch the chip from SPI Boot mode to Download Boot mode by setting register [LP_AON_FORCE_DOWNLOAD_BOOT](#) and triggering a CPU reset. If this eFuse is 1, [LP_AON_FORCE_DOWNLOAD_BOOT](#) is disabled.

- [EFUSE_DIS_DOWNLOAD_MODE](#)

If this eFuse is 1, Download Boot mode is permanently disabled.

- [EFUSE_ENABLE_SECURITY_DOWNLOAD](#)

If this eFuse is 1, Download Boot mode only allows reading, writing, and erasing plaintext flash and does not support any SRAM or register operations. Ignore this eFuse if Download Boot mode is disabled.

USB Serial/JTAG Controller can also force switch the chip to Download Boot mode from SPI Boot mode, and vice versa. For detailed information, please refer to Chapter 31 [USB Serial/JTAG Controller \(USB_SERIAL_JTAG\)](#).

9.2.3 ROM Messages Printing Control

GPIO8 controls ROM messages printing during the early SPI Boot process. This GPIO is used together with [EFUSE_UART_PRINT_CONTROL](#).

Table 9-3. ROM Message Printing Control

eFuse ¹	GPIO8	ROM Code Printing
0	x	ROM messages are always printed to UART0 during boot.
1	0	Print is enabled during boot.
	1	Print is disabled during boot.
2	0	Print is disabled during boot.
	1	Print is enabled during boot.
3	x	Print is always disabled during boot.

¹ eFuse: [EFUSE_UART_PRINT_CONTROL](#)

ROM message is printed to UART0 and USB Serial/JTAG Controller by default during power-on. You can disable the printing to USB Serial/JTAG Controller by setting the eFuse bit [EFUSE_DIS_USB_SERIAL_JTAG_ROM_PRINT](#).

Note that if [EFUSE_DIS_USB_SERIAL_JTAG_ROM_PRINT](#) is set to 0 to print to USB, but USB Serial/JTAG Controller has been disabled, then ROM messages will not be printed to USB Serial/JTAG Controller.

9.2.4 JTAG Signal Source Control

GPIO15 controls the source of JTAG signals during the early boot process. This GPIO is used together with [EFUSE_DIS_PAD_JTAG](#), [EFUSE_DIS_USB_JTAG](#), and [EFUSE_JTAG_SEL_ENABLE](#). See Table 9-4.

Table 9-4. JTAG Signal Source Control

eFuse 1 ^a	eFuse 2 ^b	eFuse 3 ^c	GPIO15	Signal Source
0	0	0	x	JTAG signals come from USB Serial/JTAG Controller.
		1	0	JTAG signals come from corresponding pins ^d
				1
0	1	x	x	JTAG signals come from corresponding pins ^d
1	0	x	x	JTAG signals come from USB Serial/JTAG Controller.
1	1	x	x	JTAG is disabled.

^a eFuse 1: [EFUSE_DIS_PAD_JTAG](#)

^b eFuse 2: [EFUSE_DIS_USB_JTAG](#)

^c eFuse 3: [EFUSE_JTAG_SEL_ENABLE](#)

^d JTAG pins: MTDI, MTCK, MTMS, and MTDO

9.2.5 SDIO Sampling Input Edge and Output Driving Edge Control

The strapping pin MTMS and MTDI can be used to control the input sampling edge and the output driving edge. See [Table 9-5 SDIO Input Sampling Edge/Output Driving Edge Control](#). For more information about SDIO sampling control, see [Chapter 33 SDIO 2.0 Slave Controller \(SDIO\)](#).

Table 9-5. SDIO Input Sampling Edge/Output Driving Edge Control

MTMS	MTDI	Edge behavior
0	0	Falling edge sampling, falling edge output
0	1	Falling edge sampling, rising edge output
1	0	Rising edge sampling, falling edge output
1	1	Rising edge sampling, rising edge output

10 Interrupt Matrix (INTMTX)

10.1 Overview

The interrupt matrix embedded in ESP32-C6 independently routes peripheral interrupt sources to the ESP-RISC-V CPU's peripheral interrupts to timely inform CPU to process the coming interrupts.

The ESP32-C6 has 77 peripheral interrupt sources that can be routed to any of the 28 CPU interrupts using the interrupt matrix.

Note:

This chapter focuses on how to map peripheral interrupt sources to CPU interrupts. For more details about interrupt configuration, vector, and interrupt handling operations recommended by the ISA, please refer to Chapter 1 [High-Performance CPU](#).

10.2 Features

The interrupt matrix embedded in ESP32-C6 has the following features:

- 77 peripheral interrupt sources accepted as input
- 31 CPU peripheral interrupts generated to CPU as output
- Current interrupt status query of peripheral interrupt sources
- Multiple interrupt sources mapping to a single CPU interrupt (i.e., shared interrupts)

Figure 10-1 shows the structure of the interrupt matrix.

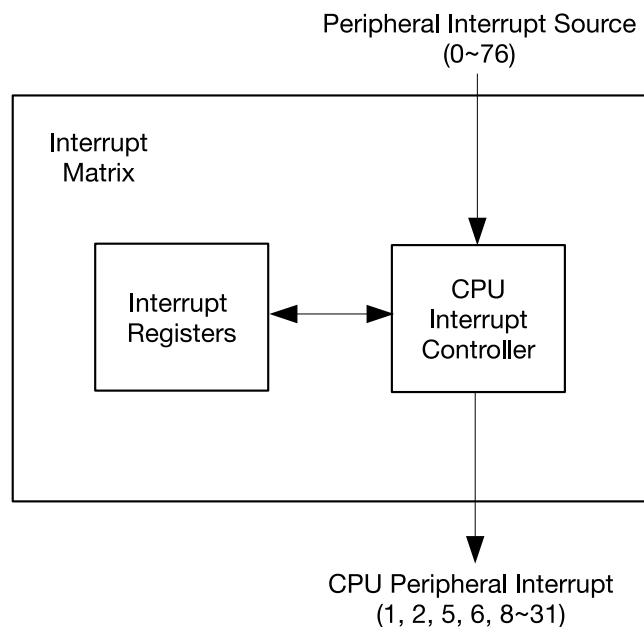

Figure 10-1. Interrupt Matrix Structure

10.3 Functional Description

10.3.1 Peripheral Interrupt Sources

The ESP32-C6 has 77 peripheral interrupt sources in total. Table 10-1 lists all these sources and their mapping/status registers.

- Column “No.”: Peripheral interrupt source number, can be 0 ~ 76.
- Column “Chapter”: in which chapter the interrupt source is described in detail.
- Column “Interrupt Source”: Name of the peripheral interrupt source.
- Column “Interrupt Source Mapping Register”: Registers used for routing the peripheral interrupt sources to CPU peripheral interrupts.
- Column “Interrupt Status Register”: Registers used for indicating the interrupt status of peripheral interrupt sources.
 - Column “Interrupt Status Register - Bit”: Bit position in status register, indicating the interrupt status.
 - Column “Interrupt Status Register - Name”: Name of status registers.

Table 10-1. CPU Peripheral Interrupt Source Mapping/Status Registers and Peripheral Interrupt Sources

No.	Chapter	Interrupt Source	Interrupt Source Mapping Register	Bit	Interrupt Status Register
					Name
0	n/a	reserved	reserved	0	INTMTX_CORE0_INT_STATUS_0_REG
1	n/a	reserved	reserved	1	
2	n/a	reserved	reserved	2	
3	n/a	reserved	reserved	3	
4	n/a	reserved	reserved	4	
5	n/a	reserved	reserved	5	
6	n/a	reserved	reserved	6	
7	n/a	reserved	reserved	7	
8	n/a	reserved	reserved	8	
9	n/a	reserved	reserved	9	
10	n/a	reserved	reserved	10	
11	n/a	reserved	reserved	11	
12	n/a	reserved	reserved	12	
13	Low-Power Management [to be added later]	PMU_INTR	INTMTX_CORE0_PMU_INTR_MAP_REG	13	
14	eFuse Controller	EFUSE_INTR	INTMTX_CORE0_EFUSE_INTR_MAP_REG	14	
15	Low-Power Management [to be added later]	LP_RTC_TIMER_INTR	INTMTX_CORE0_LP_RTC_TIMER_INTR_MAP_REG	15	
16	UART Controller (UART, LP_UART, UHC)	LP_UART_INTR	INTMTX_CORE0_LP_UART_INTR_MAP_REG	16	
17	I2C Controller (I2C)	LP_I2C_INTR	INTMTX_CORE0_LP_I2C_INTR_MAP_REG	17	
18	Low-Power Management [to be added later]	LP_WDT_INTR	INTMTX_CORE0_LP_WDT_INTR_MAP_REG	18	
19	System Registers (HP_SYSTEM)	LP_PERI_TIMEOUT_INTR	INTMTX_CORE0_LP_PERI_TIMEOUT_INTR_MAP_REG	19	
20	Permission Control (PMS)	LP_APM_M0_INTR	INTMTX_CORE0_LP_APM_M0_INTR_MAP_REG	20	
21	Permission Control (PMS)	LP_APM_M1_INTR	INTMTX_CORE0_LP_APM_M1_INTR_MAP_REG	21	
22	High-Performance CPU	CPU_INTR_FROM_CPU_0	INTMTX_CORE0_CPU_INTR_FROM_CPU_0_MAP_REG	22	
23	High-Performance CPU	CPU_INTR_FROM_CPU_1	INTMTX_CORE0_CPU_INTR_FROM_CPU_1_MAP_REG	23	
24	High-Performance CPU	CPU_INTR_FROM_CPU_2	INTMTX_CORE0_CPU_INTR_FROM_CPU_2_MAP_REG	24	
25	High-Performance CPU	CPU_INTR_FROM_CPU_3	INTMTX_CORE0_CPU_INTR_FROM_CPU_3_MAP_REG	25	
26	Debug Assistant (ASSIST_DEBUG)	ASSIST_DEBUG_INTR	INTMTX_CORE0_ASSIST_DEBUG_INTR_MAP_REG	26	
27	High-Performance CPU	TRACE_INTR	INTMTX_CORE0_TRACE_INTR_MAP_REG	27	
28	Cache [to be added later]	CACHE_INTR	INTMTX_CORE0_CACHE_INTR_MAP_REG	28	
29	System Registers (HP_SYSTEM)	CPU_PERI_TIMEOUT_INTR	INTMTX_CORE0_CPU_PERI_TIMEOUT_INTR_MAP_REG	29	
30	IO MUX and GPIO Matrix (GPIO, IO MUX)	GPIO_INTERRUPT_PRO	INTMTX_CORE0_GPIO_INTERRUPT_PRO_MAP_REG	30	
31	IO MUX and GPIO Matrix (GPIO, IO MUX)	GPIO_INTERRUPT_PRO_NMI	INTMTX_CORE0_GPIO_INTERRUPT_PRO_NMI_MAP_REG	31	

No.	Chapter	Interrupt Source	Interrupt Source Mapping Register	Bit	Interrupt Status Register
					Name
32	<i>Low-Power Management [to be added later]</i>	PAU_INTR	INTMTX_CORE0_PAU_INTR_MAP_REG	0	INTMTX_CORE0_INT_STATUS_1_REG
33	<i>System Registers (HP_SYSTEM)</i>	HP_PERI_TIMEOUT_INTR	INTMTX_CORE0_HP_PERI_TIMEOUT_INTR_MAP_REG	1	
34	n/a	reserved	reserved	2	
35	<i>Permission Control (PMS)</i>	HP_APM_M0_INTR	INTMTX_CORE0_HP_APM_M0_INTR_MAP_REG	3	
36	<i>Permission Control (PMS)</i>	HP_APM_M1_INTR	INTMTX_CORE0_HP_APM_M1_INTR_MAP_REG	4	
37	<i>Permission Control (PMS)</i>	HP_APM_M2_INTR	INTMTX_CORE0_HP_APM_M2_INTR_MAP_REG	5	
38	<i>Permission Control (PMS)</i>	HP_APM_M3_INTR	INTMTX_CORE0_HP_APM_M3_INTR_MAP_REG	6	
39	<i>Permission Control (PMS)</i>	LP_APM0_INTR	INTMTX_CORE0_LP_APM0_INTR_MAP_REG	7	
40	<i>SPI Controller (SPI)</i>	MSPI_INTR	INTMTX_CORE0_MSPI_INTR_MAP_REG	8	
41	<i>I2S Controller (I2S)</i>	I2S_INTR	INTMTX_CORE0_I2S_INTR_MAP_REG	9	
42	<i>UART Controller (UART, LP_UART, UHCI)</i>	UHCIO_INTR	INTMTX_CORE0_UHCIO_INTR_MAP_REG	10	
43	<i>UART Controller (UART, LP_UART, UHCI)</i>	UART0_INTR	INTMTX_CORE0_UART0_INTR_MAP_REG	11	
44	<i>UART Controller (UART, LP_UART, UHCI)</i>	UART1_INTR	INTMTX_CORE0_UART1_INTR_MAP_REG	12	
45	<i>LED PWM Controller (LEDC)</i>	LEDC_INTR	INTMTX_CORE0_LEDC_INTR_MAP_REG	13	
46	<i>Two-wire Automotive Interface (TWAI)</i>	TWAI0_INTR	INTMTX_CORE0_TWAI0_INTR_MAP_REG	14	
47	<i>Two-wire Automotive Interface (TWAI)</i>	TWAI1_INTR	INTMTX_CORE0_TWAI1_INTR_MAP_REG	15	
48	<i>USB Serial/JTAG Controller (USB_SERIAL_JTAG)</i>	USB_SERIAL_JTAG_INTR	INTMTX_CORE0_USB_INTR_MAP_REG	16	
49	<i>Remote Control Peripheral (RMT)</i>	RMT_INTR	INTMTX_CORE0_RMT_INTR_MAP_REG	17	
50	<i>I2C Controller (I2C)</i>	I2C_EXT0_INTR	INTMTX_CORE0_I2C_EXT0_INTR_MAP_REG	18	
51	<i>Timer Group (TIMG)</i>	TG0_T0_INTR	INTMTX_CORE0_TG0_T0_INTR_MAP_REG	19	
52	<i>Timer Group (TIMG)</i>	TG0_T1_INTR	INTMTX_CORE0_TG0_T1_INTR_MAP_REG	20	
53	<i>Timer Group (TIMG)</i>	TG0_WDT_INTR	INTMTX_CORE0_TG0_WDT_INTR_MAP_REG	21	
54	<i>Timer Group (TIMG)</i>	TG1_T0_INTR	INTMTX_CORE0_TG1_T0_INTR_MAP_REG	22	
55	<i>Timer Group (TIMG)</i>	TG1_T1_INTR	INTMTX_CORE0_TG1_T1_INTR_MAP_REG	23	
56	<i>Timer Group (TIMG)</i>	TG1_WDT_INTR	INTMTX_CORE0_TG1_WDT_INTR_MAP_REG	24	
57	<i>System Timer (SYSTIMER)</i>	SYSTIMER_TARGET0_INTR	INTMTX_CORE0_SYSTIMER_TARGET0_INTR_MAP_REG	25	
58	<i>System Timer (SYSTIMER)</i>	SYSTIMER_TARGET1_INTR	INTMTX_CORE0_SYSTIMER_TARGET1_INTR_MAP_REG	26	
59	<i>System Timer (SYSTIMER)</i>	SYSTIMER_TARGET2_INTR	INTMTX_CORE0_SYSTIMER_TARGET2_INTR_MAP_REG	27	
60	<i>On-Chip Sensor and Analog Signal Processing</i>	APB_ADC_INTR	INTMTX_CORE0_APB_ADC_INTR_MAP_REG	28	
61	<i>Motor Control PWM (MCPWM)</i>	PWM_INTR	INTMTX_CORE0_PWM_INTR_MAP_REG	29	
62	<i>Pulse Count Controller (PCNT)</i>	PCNT_INTR	INTMTX_CORE0_PCNT_INTR_MAP_REG	30	
63	<i>Parallel IO Controller (PARL_IO)</i>	PARL_IO_INTR	INTMTX_CORE0_PARL_IO_INTR_MAP_REG	31	

No.	Chapter	Interrupt Source	Interrupt Source Mapping Register	Bit	Interrupt Status Register
					Name
64	<i>Reset and Clock</i>	SLC0_INTR	INTMTX_CORE0_SLC0_INTR_MAP_REG	0	INTMTX_CORE0_INT_STATUS_2_REG
65	<i>Reset and Clock</i>	SLC1_INTR	INTMTX_CORE0_SLC1_INTR_MAP_REG	1	
66	<i>GDMA Controller (GDMA)</i>	GDMA_IN_CH0_INTR	INTMTX_CORE0_DMA_IN_CH0_INTR_MAP_REG	2	
67	<i>GDMA Controller (GDMA)</i>	GDMA_IN_CH1_INTR	INTMTX_CORE0_DMA_IN_CH1_INTR_MAP_REG	3	
68	<i>GDMA Controller (GDMA)</i>	GDMA_IN_CH2_INTR	INTMTX_CORE0_DMA_IN_CH2_INTR_MAP_REG	4	
69	<i>GDMA Controller (GDMA)</i>	GDMA_OUT_CH0_INTR	INTMTX_CORE0_DMA_OUT_CH0_INTR_MAP_REG	5	
70	<i>GDMA Controller (GDMA)</i>	GDMA_OUT_CH1_INTR	INTMTX_CORE0_DMA_OUT_CH1_INTR_MAP_REG	6	
71	<i>GDMA Controller (GDMA)</i>	GDMA_OUT_CH2_INTR	INTMTX_CORE0_DMA_OUT_CH2_INTR_MAP_REG	7	
72	<i>SPI Controller (SPI)</i>	GPSPi2_INTR	INTMTX_CORE0_GPSPi2_INTR_MAP_REG	8	
73	<i>AES Accelerator (AES)</i>	AES_INTR	INTMTX_CORE0_AES_INTR_MAP_REG	9	
74	<i>SHA Accelerator (SHA)</i>	SHA_INTR	INTMTX_CORE0_SHA_INTR_MAP_REG	10	
75	<i>RSA Accelerator (RSA)</i>	RSA_INTR	INTMTX_CORE0_RSA_INTR_MAP_REG	11	
76	<i>ECC Accelerator (ECC)</i>	ECC_INTR	INTMTX_CORE0_ECC_INTR_MAP_REG	12	

10.3.2 CPU Interrupts

The ESP32-C6 implements its interrupt mechanism using an interrupt controller instead of RISC-V Privileged ISA specification. The CPU has 32 interrupts, numbered from 0 ~ 31. The interrupts numbered 0, 3, 4, and 7 are used by the CPU for core-local interrupts (CLINT), while the remaining 28 interrupts (numbered 1, 2, 5, 6, and 8 ~ 31) are available for use in the interrupt matrix.

Each CPU interrupt has the following properties:

- Priority levels from 1 (lowest) to 15 (highest).
- Configurable as level-triggered or edge-triggered.
- Lower-priority interrupts mask-able by setting interrupt threshold.

Note:

For detailed information about the function and configuration of CPU interrupts, see Chapter 1 *High-Performance CPU*.

10.3.3 Assign Peripheral Interrupt Source to CPU Interrupt

In this section, the following terms are used to describe the operation of the interrupt matrix.

- Source_X: stands for a peripheral interrupt source, wherein X means the number of this interrupt source in Table 10-1.
- INTMTX_CORE0_SOURCE_X_INTR_MAP_REG: stands for an interrupt source mapping register for the peripheral interrupt source (Source_X).
- Num_P: the index of CPU interrupts which can be 1, 2, 5, 6, 8 ~ 31.
- Interrupt_P: stands for the CPU interrupt numbered as Num_P.

10.3.3.1 Assign One Peripheral Interrupt Source (Source_X) to CPU

Setting the corresponding source mapping register INTMTX_CORE0_SOURCE_X_INTR_MAP_REG of Source_X to Num_P assigns this interrupt source to Interrupt_P.

10.3.3.2 Assign Multiple Peripheral Interrupt Sources (Source_X) to CPU

Setting the corresponding source mapping register INTMTX_CORE0_SOURCE_X_INTR_MAP_REG of each interrupt source to the same Num_P assigns multiple sources to the same Interrupt_P. Any of these sources can trigger CPU Interrupt_P. When an interrupt signal is generated, CPU should check the interrupt status registers to figure out which peripheral generated the interrupt. For more information, see Chapter 1 *High-Performance CPU*.

10.3.3.3 Disable CPU Peripheral Interrupt Source (Source_X)

Writing 0 to the INTMTX_CORE0_SOURCE_X_INTR_MAP_REG register disables the corresponding interrupt source.

10.3.4 Query Current Interrupt Status of Peripheral Interrupt Source

After enabling peripheral interrupt sources, users can query current interrupt status of a peripheral interrupt source by reading the bit value in `INTMTX_CORE0_INT_STATUS_n_REG` (read only). For the mapping between `INTMTX_CORE0_INT_STATUS_n_REG` and peripheral interrupt sources, please refer to Table 10-1.

10.4 Register Summary

10.4.1 Interrupt Matrix Register Summary

The addresses in this section are relative to the interrupt matrix base address provided in Table 5-2 in Chapter 5 *System and Memory*.

The abbreviations given in Column **Access** are explained in Section *Access Types for Registers*.

Name	Description	Address	Access
Interrupt Source Mapping Register			
INTMTX_CORE0_PMU_INTR_MAP_REG	PMU_INTR mapping register	0x0034	R/W
INTMTX_CORE0_EFUSE_INTR_MAP_REG	EFUSE_INTR mapping register	0x0038	R/W
INTMTX_CORE0_LP_RTC_TIMER_INTR_MAP_REG	LP_RTC_TIMER_INTR mapping register	0x003C	R/W
INTMTX_CORE0_LP_UART_INTR_MAP_REG	LP_UART_INTR mapping register	0x0040	R/W
INTMTX_CORE0_LP_I2C_INTR_MAP_REG	LP_I2C_INTR mapping register	0x0044	R/W
INTMTX_CORE0_LP_WDT_INTR_MAP_REG	LP_WDT_INTR mapping register	0x0048	R/W
INTMTX_CORE0_LP_PERI_TIMEOUT_INTR_MAP_REG	LP_PERI_TIMEOUT_INTR mapping register	0x004C	R/W
INTMTX_CORE0_LP_APM_M0_INTR_MAP_REG	LP_APM_M0_INTR mapping register	0x0050	R/W
INTMTX_CORE0_LP_APM_M1_INTR_MAP_REG	LP_APM_M1_INTR mapping register	0x0054	R/W
INTMTX_CORE0_CPU_INTR_FROM_CPU_0_MAP_REG	CPU_INTR_FROM_CPU_0 mapping register	0x0058	R/W
INTMTX_CORE0_CPU_INTR_FROM_CPU_1_MAP_REG	CPU_INTR_FROM_CPU_1 mapping register	0x005C	R/W
INTMTX_CORE0_CPU_INTR_FROM_CPU_2_MAP_REG	CPU_INTR_FROM_CPU_2 mapping register	0x0060	R/W
INTMTX_CORE0_CPU_INTR_FROM_CPU_3_MAP_REG	CPU_INTR_FROM_CPU_3 mapping register	0x0064	R/W
INTMTX_CORE0_ASSIST_DEBUG_INTR_MAP_REG	ASSIST_DEBUG_INTR mapping register	0x0068	R/W
INTMTX_CORE0_TRACE_INTR_MAP_REG	TRACE_INTR mapping register	0x006C	R/W
INTMTX_CORE0_CACHE_INTR_MAP_REG	CACHE_INTR mapping register	0x0070	R/W
INTMTX_CORE0_CPU_PERI_TIMEOUT_INTR_MAP_REG	CPU_PERI_TIMEOUT_INTR mapping register	0x0074	R/W
INTMTX_CORE0_GPIO_INTERRUPT_PRO_MAP_REG	GPIO_INTERRUPT_PRO mapping register	0x0078	R/W
INTMTX_CORE0_GPIO_INTERRUPT_PRO_NMI_MAP_REG	GPIO_INTERRUPT_PRO_NMI mapping register	0x007C	R/W
INTMTX_CORE0_PAU_INTR_MAP_REG	PAU_INTR mapping register	0x0080	R/W
INTMTX_CORE0_HP_PERI_TIMEOUT_INTR_MAP_REG	HP_PERI_TIMEOUT_INTR mapping register	0x0084	R/W
INTMTX_CORE0_HP_APM_M0_INTR_MAP_REG	HP_APM_M0_INTR mapping register	0x008C	R/W

Name	Description	Address	Access
INTMTX_CORE0_HP_APM_M1_INTR_MAP_REG	HP_APM_M1_INTR mapping register	0x0090	R/W
INTMTX_CORE0_HP_APM_M2_INTR_MAP_REG	HP_APM_M2_INTR mapping register	0x0094	R/W
INTMTX_CORE0_HP_APM_M3_INTR_MAP_REG	HP_APM_M3_INTR mapping register	0x0098	R/W
INTMTX_CORE0_LP_APM0_INTR_MAP_REG	LP_APM0_INTR mapping register	0x009C	R/W
INTMTX_CORE0_MSPI_INTR_MAP_REG	MSPI_INTR mapping register	0x00A0	R/W
INTMTX_CORE0_I2S_INTR_MAP_REG	I2S_INTR mapping register	0x00A4	R/W
INTMTX_CORE0_UHCI0_INTR_MAP_REG	UHCI0_INTR mapping register	0x00A8	R/W
INTMTX_CORE0_UART0_INTR_MAP_REG	UART0_INTR mapping register	0x00AC	R/W
INTMTX_CORE0_UART1_INTR_MAP_REG	UART1_INTR mapping register	0x00B0	R/W
INTMTX_CORE0_LEDC_INTR_MAP_REG	LEDC_INTR mapping register	0x00B4	R/W
INTMTX_CORE0_TWAI0_INTR_MAP_REG	TWAI0_INTR mapping register	0x00B8	R/W
INTMTX_CORE0_TWAI1_INTR_MAP_REG	TWAI1_INTR mapping register	0x00BC	R/W
INTMTX_CORE0_USB_INTR_MAP_REG	USB_SERIAL_JTAG_INTR mapping register	0x00C0	R/W
INTMTX_CORE0_RMT_INTR_MAP_REG	RMT_INTR mapping register	0x00C4	R/W
INTMTX_CORE0_I2C_EXT0_INTR_MAP_REG	I2C_EXT0_INTR mapping register	0x00C8	R/W
INTMTX_CORE0_TG0_T0_INTR_MAP_REG	TG0_T0_INTR mapping register	0x00CC	R/W
INTMTX_CORE0_TG0_T1_INTR_MAP_REG	TG0_T1_INTR mapping register	0x00D0	R/W
INTMTX_CORE0_TG0_WDT_INTR_MAP_REG	TG0_WDT_INTR mapping register	0x00D4	R/W
INTMTX_CORE0_TG1_T0_INTR_MAP_REG	TG1_T0_INTR mapping register	0x00D8	R/W
INTMTX_CORE0_TG1_T1_INTR_MAP_REG	TG1_T1_INTR mapping register	0x00DC	R/W
INTMTX_CORE0_TG1_WDT_INTR_MAP_REG	TG1_WDT_INTR mapping register	0x00E0	R/W
INTMTX_CORE0_SYSTIMER_TARGET0_INTR_MAP_REG	SYSTIMER_TARGET0_INTR mapping register	0x00E4	R/W
INTMTX_CORE0_SYSTIMER_TARGET1_INTR_MAP_REG	SYSTIMER_TARGET1_INTR mapping register	0x00E8	R/W
INTMTX_CORE0_SYSTIMER_TARGET2_INTR_MAP_REG	SYSTIMER_TARGET2_INTR mapping register	0x00EC	R/W
INTMTX_CORE0_APB_ADC_INTR_MAP_REG	APB_ADC_INTR mapping register	0x00F0	R/W
INTMTX_CORE0_PWM_INTR_MAP_REG	PWM_INTR mapping register	0x00F4	R/W
INTMTX_CORE0_PCNT_INTR_MAP_REG	PCNT_INTR mapping register	0x00F8	R/W
INTMTX_CORE0_PARL_IO_INTR_MAP_REG	PARL_IO_INTR mapping register	0x00FC	R/W
INTMTX_CORE0_SLC0_INTR_MAP_REG	SLC0_INTR mapping register	0x0100	R/W

Name	Description	Address	Access
INTMTX_CORE0_SLC1_INTR_MAP_REG	SLC1_INTR mapping register	0x0104	R/W
INTMTX_CORE0_DMA_IN_CH0_INTR_MAP_REG	GDMA_IN_CH0_INTR mapping register	0x0108	R/W
INTMTX_CORE0_DMA_IN_CH1_INTR_MAP_REG	GDMA_IN_CH1_INTR mapping register	0x010C	R/W
INTMTX_CORE0_DMA_IN_CH2_INTR_MAP_REG	GDMA_IN_CH2_INTR mapping register	0x0110	R/W
INTMTX_CORE0_DMA_OUT_CH0_INTR_MAP_REG	GDMA_OUT_CH0_INTR mapping register	0x0114	R/W
INTMTX_CORE0_DMA_OUT_CH1_INTR_MAP_REG	GDMA_OUT_CH1_INTR mapping register	0x0118	R/W
INTMTX_CORE0_DMA_OUT_CH2_INTR_MAP_REG	GDMA_OUT_CH2_INTR mapping register	0x011C	R/W
INTMTX_CORE0_GPSPI2_INTR_MAP_REG	GPSPI2_INTR mapping register	0x0120	R/W
INTMTX_CORE0_AES_INTR_MAP_REG	AES_INTR mapping register	0x0124	R/W
INTMTX_CORE0_SHA_INTR_MAP_REG	SHA_INTR mapping register	0x0128	R/W
INTMTX_CORE0_RSA_INTR_MAP_REG	RSA_INTR mapping register	0x012C	R/W
INTMTX_CORE0_ECC_INTR_MAP_REG	ECC_INTR mapping register	0x0130	R/W
Interrupt Status Register			
INTMTX_CORE0_INT_STATUS_0_REG	Status register for interrupt sources 0 ~ 31	0x0134	RO
INTMTX_CORE0_INT_STATUS_1_REG	Status register for interrupt sources 32 ~ 63	0x0138	RO
INTMTX_CORE0_INT_STATUS_2_REG	Status register for interrupt sources 64 ~ 76	0x013C	RO
Version Control Register			
INTMTX_CORE0_INTERRUPT_REG_DATE_REG	Version control register	0x07FC	R/W

10.4.2 Interrupt Priority Register Summary

The addresses in this section are relative to the interrupt priority base address provided in Table 5-2 in Chapter 5 *System and Memory*.

The abbreviations given in Column **Access** are explained in Section *Access Types for Registers*.

Name	Description	Address	Access
Configuration Registers			
INTPRI_CORE0_CPU_INT_ENABLE_REG	Enable register for CPU interrupts	0x0000	R/W
INTPRI_CORE0_CPU_INT_TYPE_REG	Type configuration register for CPU interrupts	0x0004	R/W
INTPRI_CORE0_CPU_INT_EIP_STATUS_REG	Pending status register for CPU interrupts	0x0008	RO

Name	Description	Address	Access
INTPRI_CORE0_CPU_INT_PRI_0_REG	Priority configuration register for CPU interrupt 0	0x000C	R/W
INTPRI_CORE0_CPU_INT_PRI_1_REG	Priority configuration register for CPU interrupt 1	0x0010	R/W
INTPRI_CORE0_CPU_INT_PRI_2_REG	Priority configuration register for CPU interrupt 2	0x0014	R/W
INTPRI_CORE0_CPU_INT_PRI_3_REG	Priority configuration register for CPU interrupt 3	0x0018	R/W
INTPRI_CORE0_CPU_INT_PRI_4_REG	Priority configuration register for CPU interrupt 4	0x001C	R/W
INTPRI_CORE0_CPU_INT_PRI_5_REG	Priority configuration register for CPU interrupt 5	0x0020	R/W
INTPRI_CORE0_CPU_INT_PRI_6_REG	Priority configuration register for CPU interrupt 6	0x0024	R/W
INTPRI_CORE0_CPU_INT_PRI_7_REG	Priority configuration register for CPU interrupt 7	0x0028	R/W
INTPRI_CORE0_CPU_INT_PRI_8_REG	Priority configuration register for CPU interrupt 8	0x002C	R/W
INTPRI_CORE0_CPU_INT_PRI_9_REG	Priority configuration register for CPU interrupt 9	0x0030	R/W
INTPRI_CORE0_CPU_INT_PRI_10_REG	Priority configuration register for CPU interrupt 10	0x0034	R/W
INTPRI_CORE0_CPU_INT_PRI_11_REG	Priority configuration register for CPU interrupt 11	0x0038	R/W
INTPRI_CORE0_CPU_INT_PRI_12_REG	Priority configuration register for CPU interrupt 12	0x003C	R/W
INTPRI_CORE0_CPU_INT_PRI_13_REG	Priority configuration register for CPU interrupt 13	0x0040	R/W
INTPRI_CORE0_CPU_INT_PRI_14_REG	Priority configuration register for CPU interrupt 14	0x0044	R/W
INTPRI_CORE0_CPU_INT_PRI_15_REG	Priority configuration register for CPU interrupt 15	0x0048	R/W
INTPRI_CORE0_CPU_INT_PRI_16_REG	Priority configuration register for CPU interrupt 16	0x004C	R/W
INTPRI_CORE0_CPU_INT_PRI_17_REG	Priority configuration register for CPU interrupt 17	0x0050	R/W
INTPRI_CORE0_CPU_INT_PRI_18_REG	Priority configuration register for CPU interrupt 18	0x0054	R/W
INTPRI_CORE0_CPU_INT_PRI_19_REG	Priority configuration register for CPU interrupt 19	0x0058	R/W
INTPRI_CORE0_CPU_INT_PRI_20_REG	Priority configuration register for CPU interrupt 20	0x005C	R/W
INTPRI_CORE0_CPU_INT_PRI_21_REG	Priority configuration register for CPU interrupt 21	0x0060	R/W
INTPRI_CORE0_CPU_INT_PRI_22_REG	Priority configuration register for CPU interrupt 22	0x0064	R/W
INTPRI_CORE0_CPU_INT_PRI_23_REG	Priority configuration register for CPU interrupt 23	0x0068	R/W
INTPRI_CORE0_CPU_INT_PRI_24_REG	Priority configuration register for CPU interrupt 24	0x006C	R/W
INTPRI_CORE0_CPU_INT_PRI_25_REG	Priority configuration register for CPU interrupt 25	0x0070	R/W
INTPRI_CORE0_CPU_INT_PRI_26_REG	Priority configuration register for CPU interrupt 26	0x0074	R/W
INTPRI_CORE0_CPU_INT_PRI_27_REG	Priority configuration register for CPU interrupt 27	0x0078	R/W
INTPRI_CORE0_CPU_INT_PRI_28_REG	Priority configuration register for CPU interrupt 28	0x007C	R/W

Name	Description	Address	Access
INTPRI_CORE0_CPU_INT_PRI_29_REG	Priority configuration register for CPU interrupt 29	0x0080	R/W
INTPRI_CORE0_CPU_INT_PRI_30_REG	Priority configuration register for CPU interrupt 30	0x0084	R/W
INTPRI_CORE0_CPU_INT_PRI_31_REG	Priority configuration register for CPU interrupt 31	0x0088	R/W
INTPRI_CORE0_CPU_INT_THRESH_REG	Threshold configuration register for CPU interrupts	0x008C	R/W
INTPRI_CORE0_CPU_INT_CLEAR_REG	CPU interrupt clear register	0x00A8	R/W
Interrupt Registers			
INTPRI_CPU_INTR_FROM_CPU_0_REG	CPU_INTR_FROM_CPU_0 mapping register	0x0090	R/W
INTPRI_CPU_INTR_FROM_CPU_1_REG	CPU_INTR_FROM_CPU_1 mapping register	0x0094	R/W
INTPRI_CPU_INTR_FROM_CPU_2_REG	CPU_INTR_FROM_CPU_2 mapping register	0x0098	R/W
INTPRI_CPU_INTR_FROM_CPU_3_REG	CPU_INTR_FROM_CPU_3 mapping register	0x009C	R/W
Version Registers			
INTPRI_DATE_REG	Version control register	0x00A0	R/W

10.5 Registers

10.5.1 Interrupt Matrix Registers

The addresses in this section are relative to the interrupt matrix base address provided in Table 5-2 in Chapter 5 *System and Memory*.

- Register 10.1. INTMTX_CORE0_PMU_INTR_MAP_REG (0x0034)
- Register 10.2. INTMTX_CORE0_EFUSE_INTR_MAP_REG (0x0038)
- Register 10.3. INTMTX_CORE0_LP_RTC_TIMER_INTR_MAP_REG (0x003C)
- Register 10.4. INTMTX_CORE0_LP_UART_INTR_MAP_REG (0x0040)
- Register 10.5. INTMTX_CORE0_LP_I2C_INTR_MAP_REG (0x0044)
- Register 10.6. INTMTX_CORE0_LP_WDT_INTR_MAP_REG (0x0048)
- Register 10.7. INTMTX_CORE0_LP_PERI_TIMEOUT_INTR_MAP_REG (0x004C)
- Register 10.8. INTMTX_CORE0_LP_APM_M0_INTR_MAP_REG (0x0050)
- Register 10.9. INTMTX_CORE0_LP_APM_M1_INTR_MAP_REG (0x0054)
- Register 10.10. INTMTX_CORE0_CPU_INTR_FROM_CPU_0_MAP_REG (0x0058)
- Register 10.11. INTMTX_CORE0_CPU_INTR_FROM_CPU_1_MAP_REG (0x005C)
- Register 10.12. INTMTX_CORE0_CPU_INTR_FROM_CPU_2_MAP_REG (0x0060)
- Register 10.13. INTMTX_CORE0_CPU_INTR_FROM_CPU_3_MAP_REG (0x0064)
- Register 10.14. INTMTX_CORE0_ASSIST_DEBUG_INTR_MAP_REG (0x0068)
- Register 10.15. INTMTX_CORE0_TRACE_INTR_MAP_REG (0x006C)
- Register 10.16. INTMTX_CORE0_CACHE_INTR_MAP_REG (0x0070)
- Register 10.17. INTMTX_CORE0_CPU_PERI_TIMEOUT_INTR_MAP_REG (0x0074)
- Register 10.18. INTMTX_CORE0_GPIO_INTERRUPT_PRO_MAP_REG (0x0078)
- Register 10.19. INTMTX_CORE0_GPIO_INTERRUPT_PRO_NMI_MAP_REG (0x007C)
- Register 10.20. INTMTX_CORE0_PAU_INTR_MAP_REG (0x0080)
- Register 10.21. INTMTX_CORE0_HP_PERI_TIMEOUT_INTR_MAP_REG (0x0084)
- Register 10.22. INTMTX_CORE0_HP_APM_M0_INTR_MAP_REG (0x008C)
- Register 10.23. INTMTX_CORE0_HP_APM_M1_INTR_MAP_REG (0x0090)
- Register 10.24. INTMTX_CORE0_HP_APM_M2_INTR_MAP_REG (0x0094)
- Register 10.25. INTMTX_CORE0_HP_APM_M3_INTR_MAP_REG (0x0098)
- Register 10.26. INTMTX_CORE0_LP_APM0_INTR_MAP_REG (0x009C)
- Register 10.27. INTMTX_CORE0_MSPI_INTR_MAP_REG (0x00A0)
- Register 10.28. INTMTX_CORE0_I2S_INTR_MAP_REG (0x00A4)
- Register 10.29. INTMTX_CORE0_UHCIO_INTR_MAP_REG (0x00A8)
- Register 10.30. INTMTX_CORE0_UART0_INTR_MAP_REG (0x00AC)

- Register 10.31. INTMTX_CORE0_UART1_INTR_MAP_REG (0x00B0)
- Register 10.32. INTMTX_CORE0_LEDC_INTR_MAP_REG (0x00B4)
- Register 10.33. INTMTX_CORE0_TWAI0_INTR_MAP_REG (0x00B8)
- Register 10.34. INTMTX_CORE0_TWAI1_INTR_MAP_REG (0x00BC)
- Register 10.35. INTMTX_CORE0_USB_INTR_MAP_REG (0x00C0)
- Register 10.36. INTMTX_CORE0_RMT_INTR_MAP_REG (0x00C4)
- Register 10.37. INTMTX_CORE0_I2C_EXT0_INTR_MAP_REG (0x00C8)
- Register 10.38. INTMTX_CORE0_TG0_T0_INTR_MAP_REG (0x00CC)
- Register 10.39. INTMTX_CORE0_TG0_T1_INTR_MAP_REG (0x00D0)
- Register 10.40. INTMTX_CORE0_TG0_WDT_INTR_MAP_REG (0x00D4)
- Register 10.41. INTMTX_CORE0_TG1_T0_INTR_MAP_REG (0x00D8)
- Register 10.42. INTMTX_CORE0_TG1_T1_INTR_MAP_REG (0x00DC)
- Register 10.43. INTMTX_CORE0_TG1_WDT_INTR_MAP_REG (0x00E0)
- Register 10.44. INTMTX_CORE0_SYSTIMER_TARGET0_INTR_MAP_REG (0x00E4)
- Register 10.45. INTMTX_CORE0_SYSTIMER_TARGET1_INTR_MAP_REG (0x00E8)
- Register 10.46. INTMTX_CORE0_SYSTIMER_TARGET2_INTR_MAP_REG (0x00EC)
- Register 10.47. INTMTX_CORE0_APB_ADC_INTR_MAP_REG (0x00F0)
- Register 10.48. INTMTX_CORE0_PWM_INTR_MAP_REG (0x00F4)
- Register 10.49. INTMTX_CORE0_PCNT_INTR_MAP_REG (0x00F8)
- Register 10.50. INTMTX_CORE0_PARL_JO_INTR_MAP_REG (0x00FC)
- Register 10.51. INTMTX_CORE0_SLC0_INTR_MAP_REG (0x0100)
- Register 10.52. INTMTX_CORE0_SLC1_INTR_MAP_REG (0x0104)
- Register 10.53. INTMTX_CORE0_DMA_IN_CH0_INTR_MAP_REG (0x0108)
- Register 10.54. INTMTX_CORE0_DMA_IN_CH1_INTR_MAP_REG (0x010C)
- Register 10.55. INTMTX_CORE0_DMA_IN_CH2_INTR_MAP_REG (0x0110)
- Register 10.56. INTMTX_CORE0_DMA_OUT_CH0_INTR_MAP_REG (0x0114)
- Register 10.57. INTMTX_CORE0_DMA_OUT_CH1_INTR_MAP_REG (0x0118)
- Register 10.58. INTMTX_CORE0_DMA_OUT_CH2_INTR_MAP_REG (0x011C)
- Register 10.59. INTMTX_CORE0_GPSPI2_INTR_MAP_REG (0x0120)
- Register 10.60. INTMTX_CORE0_AES_INTR_MAP_REG (0x0124)
- Register 10.61. INTMTX_CORE0_SHA_INTR_MAP_REG (0x0128)
- Register 10.62. INTMTX_CORE0_RSA_INTR_MAP_REG (0x012C)
- Register 10.63. INTMTX_CORE0_ECC_INTR_MAP_REG (0x0130)

Register 10.64. INTMTX_CORE0_SOURCE_X_MAP_REG (0x0034 - 0x0130)

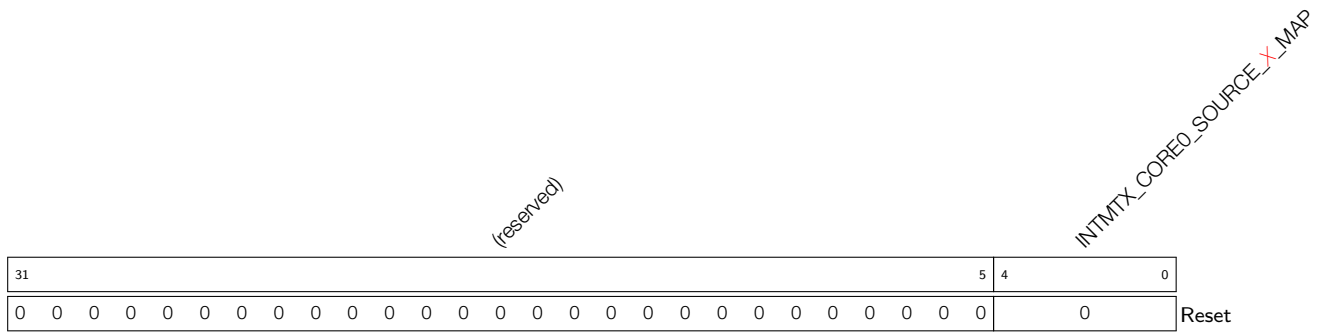

INTMTX_CORE0_SOURCE_X_MAP Map the interrupt source (SOURCE_X) into one CPU interrupt.
 For the information of SOURCE_X, see Table 10-1. (R/W)

Register 10.65. INTMTX_CORE0_INT_STATUS_0_REG (0x0134)

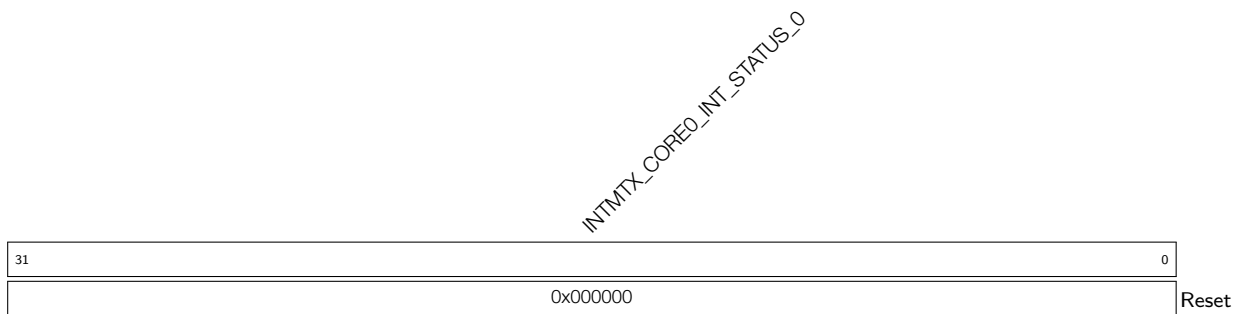

INTMTX_CORE0_INT_STATUS_0 Represents the status of the interrupt sources numbered from 0 ~ 31. Each bit corresponds to one interrupt source.
 0: The corresponding interrupt source triggered an interrupt
 1: No interrupt triggered
 (RO)

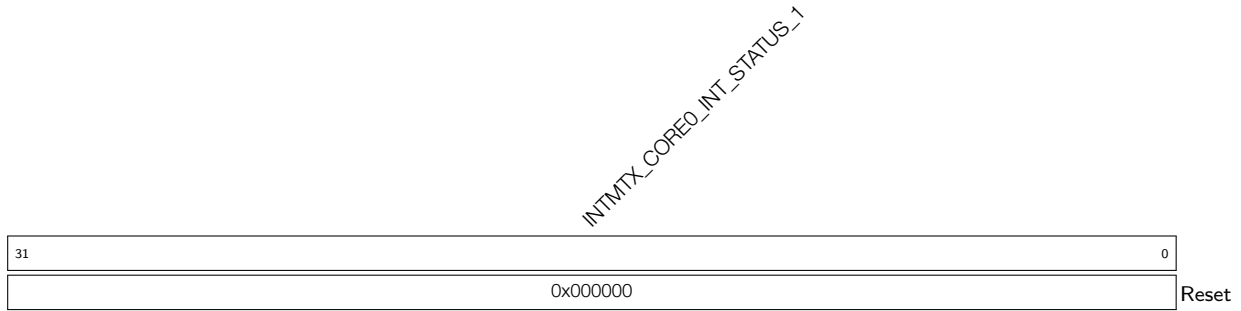
Register 10.66. INTMTX_CORE0_INT_STATUS_1_REG (0x0138)

INTMTX_CORE0_INT_STATUS_1 Represents the status of the interrupt sources numbered from 32 ~ 63. Each bit corresponds to one interrupt source.

0: The corresponding interrupt source triggered an interrupt

1: No interrupt triggered

(RO)

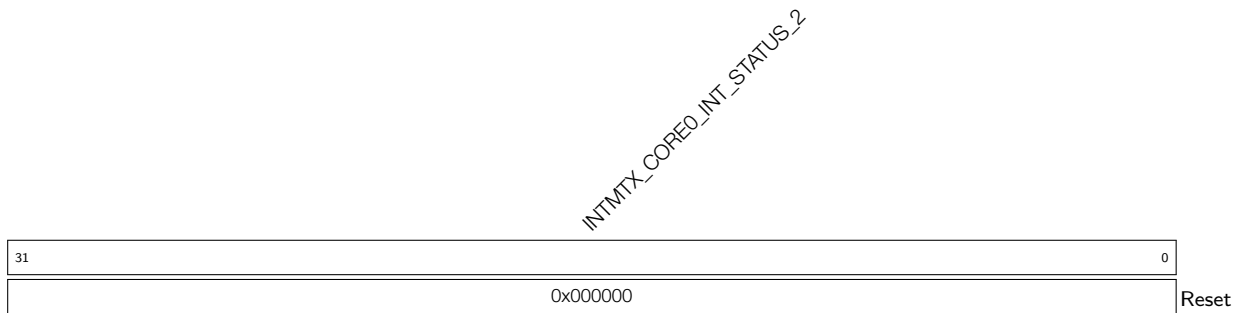
Register 10.67. INTMTX_CORE0_INT_STATUS_2_REG (0x013C)

INTMTX_CORE0_INT_STATUS_2 Represents the status of the interrupt sources numbered from 64 ~ 76. Bit 0 ~ 12 each corresponds to one interrupt source. Other bits are invalid.

0: The corresponding interrupt source triggered an interrupt

1: No interrupt triggered

(RO)

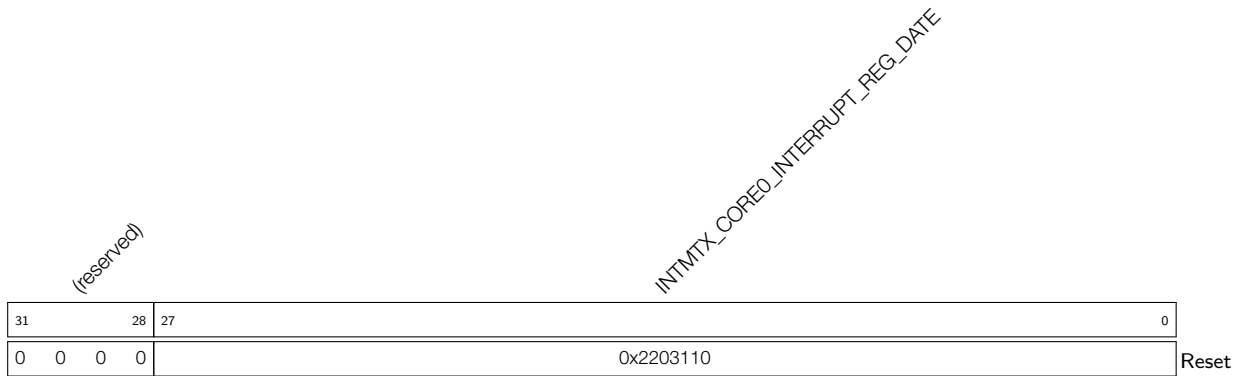
Register 10.68. INTMTX_CORE0_INTERRUPT_REG_DATE_REG (0x07FC)

INTMTX_CORE0_INTERRUPT_REG_DATE Version control register. (R/W)

10.5.2 Interrupt Priority Registers

The addresses in this section are relative to the interrupt priority base address provided in Table 5-2 in Chapter 5 *System and Memory*.

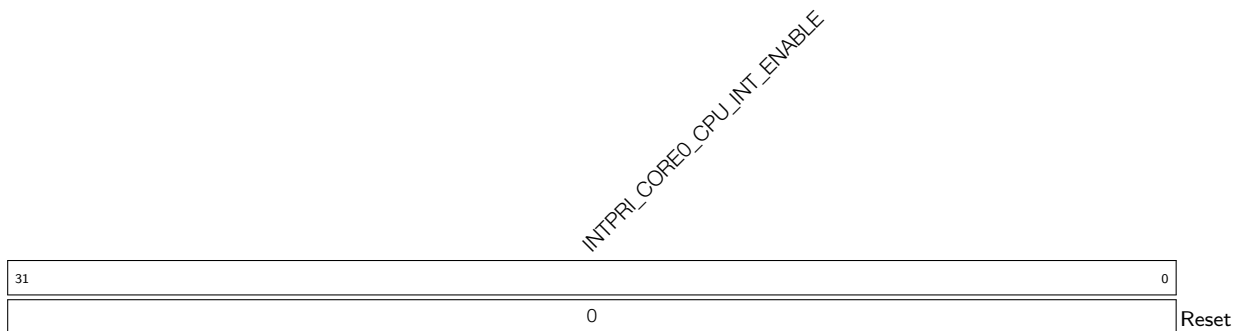
Register 10.69. INTPRI_CORE0_CPU_INT_ENABLE_REG (0x0000)

INTPRI_CORE0_CPU_INT_ENABLE Configures whether to enable the corresponding CPU interrupt.

0: Not enable

1: Enable

For more information about how to use this register, see Chapter 1 *High-Performance CPU*.

(R/W)

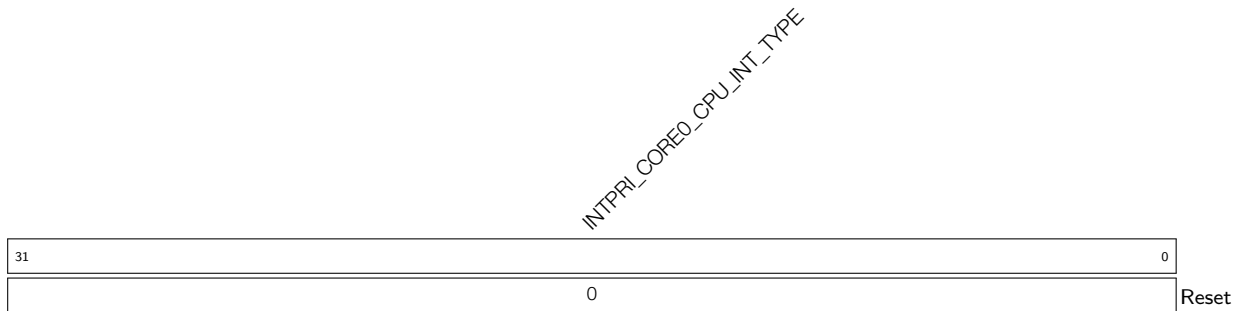
Register 10.70. INTPRI_CORE0_CPU_INT_TYPE_REG (0x0004)

INTPRI_CORE0_CPU_INT_TYPE Configures CPU interrupt type.

0: Level-triggered

1: Edge-triggered

For more information about how to use this register, see Chapter 1 [High-Performance CPU](#).

(R/W)

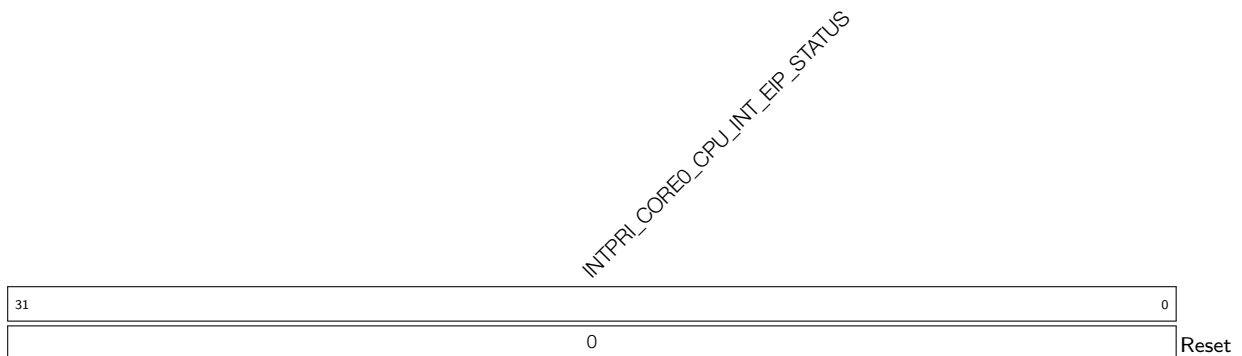
Register 10.71. INTPRI_CORE0_CPU_INT_EIP_STATUS_REG (0x0008)

INTPRI_CORE0_CPU_INT_EIP_STATUS Represents the pending status of CPU interrupts. For more information about how to use this register, see Chapter 1 [High-Performance CPU](#). (RO)

Register 10.72. INTPRI_CORE0_CPU_INT_PRI_n_REG (n: 0-31) (0x000C+0x4*n)

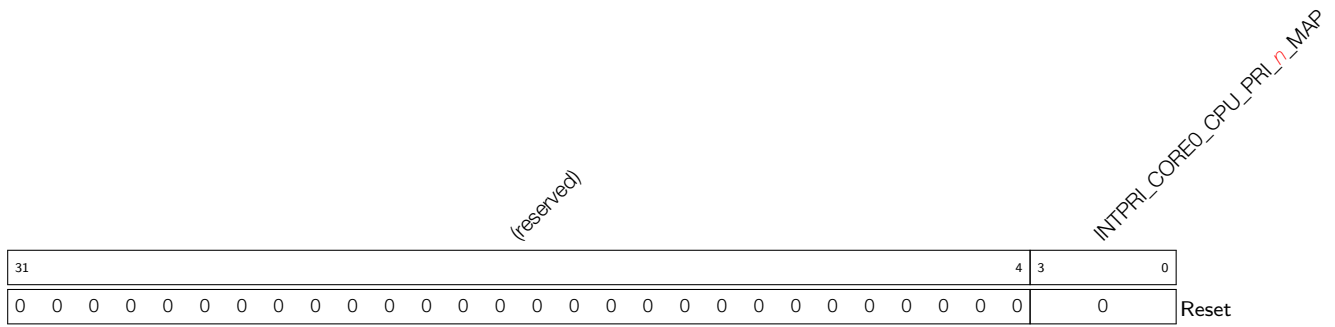

INTPRI_CORE0_CPU_PRI_n_MAP Configures the priority for CPU interrupt *n*. The priority here can be 1 (lowest) ~ 15 (highest). For more information about how to use this register, see Chapter 1 *High-Performance CPU*. (R/W)

Register 10.73. INTPRI_CORE0_CPU_INT_THRESH_REG (0x008C)

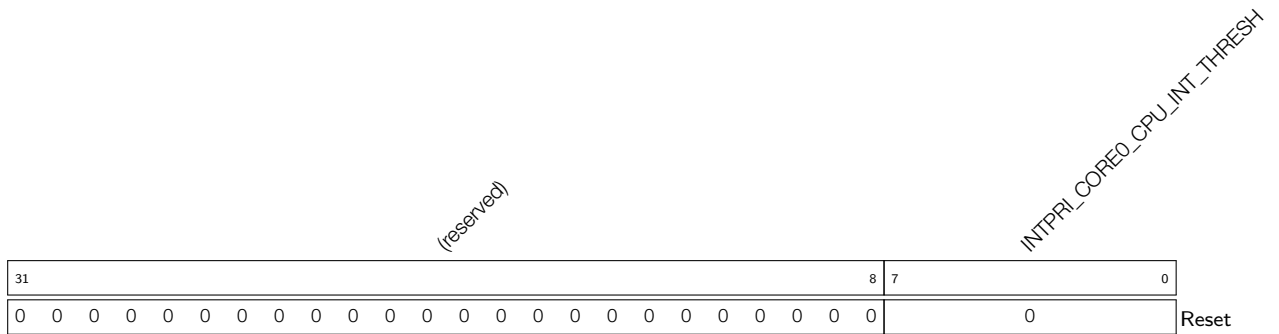

INTPRI_CORE0_CPU_INT_THRESH Configures the threshold for interrupt assertion to CPU. Only when the interrupt priority is equal to or higher than this threshold, CPU will respond to this interrupt. For more information about how to use this register, see Chapter 1 *High-Performance CPU*. (R/W)

Register 10.74. INTPRI_CORE0_CPU_INT_CLEAR_REG (0x00A8)

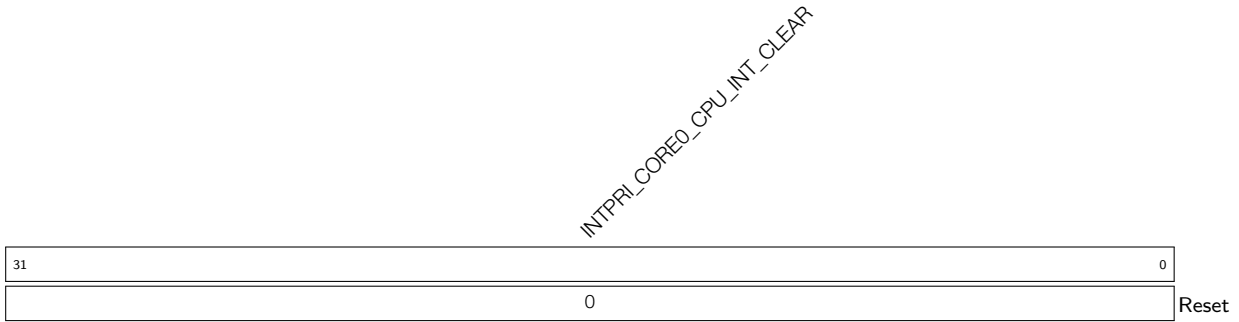

INTPRI_CORE0_CPU_INT_CLEAR Configures whether to clear the corresponding CPU interrupt.

0: No effect

1: Clear

For more information about how to use this register, see Chapter 1 *High-Performance CPU*.

(R/W)

Register 10.75. INTPRI_CPU_INTR_FROM_CPU_n_REG (n: 0-3) (0x0090+0x4*n)

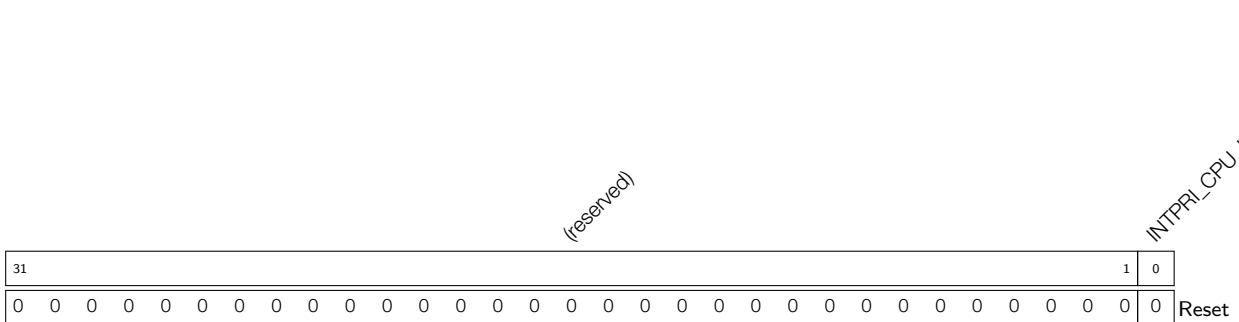

INTPRI_CPU_INTR_FROM_CPU_n CPU_INTR_FROM_CPU_n mapping register. (R/W)

Register 10.76. INTPRI_DATE_REG (0x00A0)

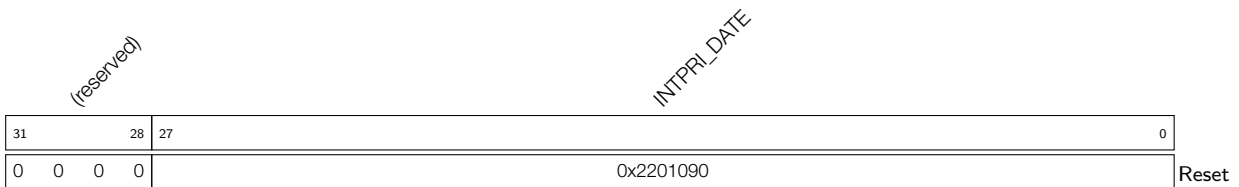

INTPRI_DATE Version control register. (R/W)

11 Event Task Matrix (SOC_ETM)

11.1 Overview

The Event Task Matrix (ETM) peripheral contains 50 configurable channels. Each channel can map an event of any specified peripheral to a task of any specified peripheral. In this way, peripherals can be triggered to execute specified tasks without CPU intervention.

11.2 Features

The Event Task Matrix has the following features:

- Receive various events from multiple peripherals
- Generate various tasks for multiple peripherals
- 50 independently configurable ETM channels
- An ETM channel can be set up to receive any event, and map it to any task
- Each ETM channel can be enabled independently. If not enabled, the channel will not respond to the configured event and generate the task mapped to that event
- Peripherals supporting ETM include GPIO, LED PWM, general-purpose timers, RTC Watchdog Timer, system timer, MCPWM, temperature sensor, ADC, I2S, LP CPU, GDMA, and PMU

Note that the 50 ETM channels are identical regarding their features and operations. Thus, in the following sections ETM channels are collectively referred to as channel n (where n ranges from 0 to 49).

11.3 Functional Description

11.3.1 Architecture

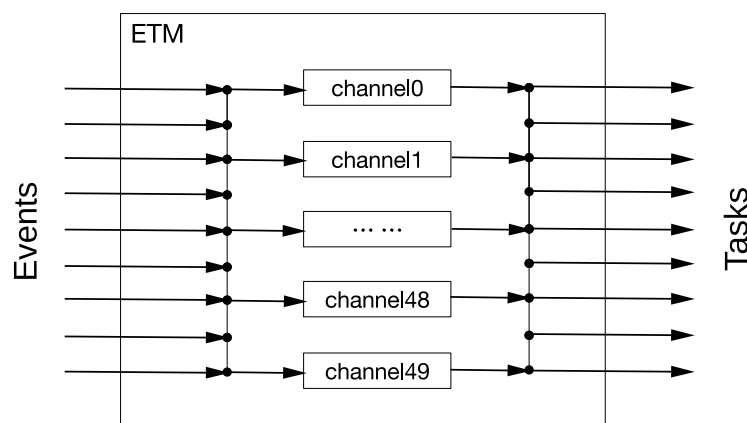

Figure 11-1. Event Task Matrix Architecture

Figure 11-1 shows the architecture of the Event Task Matrix.

The Event Task Matrix has 50 independent channels. A channel can choose any event as input, and map the event to any task as output (For configuration procedures, refer to Section 11.3.2 and Section 11.3.3

respectively). Each channel has an individual enable bit (For configuration procedures, refer to Section 11.3.5).

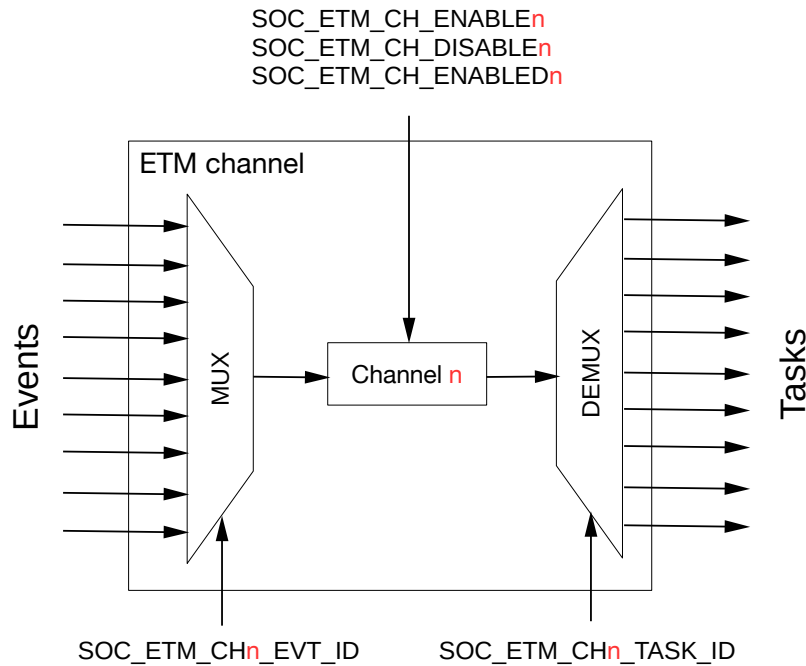

Figure 11-2. ETM Channel n Architecture

Figure 11-2 illustrates the structure of an ETM channel. The `SOC_ETM_CH n _EVT_ID` field configures the MUX (multiplexer) to select one of the events as the input of channel n . The `SOC_ETM_CH n _TASK_ID` field configures the DEMUX (demultiplexer) to map the event selected by channel n to one of the tasks. `SOC_ETM_CH_ENABLE n` and `SOC_ETM_CH_DISABLE n` are used to enable or disable channel n . `SOC_ETM_CH_ENABLED n` is used to indicate the status of the channel n .

11.3.2 Events

An ETM channel can be set up to choose which event to receive by configuring the `SOC_ETM_CH n _EVT_ID` field. Table 11-1 shows the configuration values of `SOC_ETM_CH n _EVT_ID` and their corresponding events.

Table 11-1. Selectable Events for ETM Channel n

<code>SOC_ETM_CHn_EVT_ID</code>	Selected Event	Peripheral Generating This Event
1	GPIO_EVT_CH0_RISE_EDGE	GPIO
2	GPIO_EVT_CH1_RISE_EDGE	
3	GPIO_EVT_CH2_RISE_EDGE	
4	GPIO_EVT_CH3_RISE_EDGE	
5	GPIO_EVT_CH4_RISE_EDGE	
6	GPIO_EVT_CH5_RISE_EDGE	
7	GPIO_EVT_CH6_RISE_EDGE	
8	GPIO_EVT_CH7_RISE_EDGE	
9	GPIO_EVT_CH0_FALL_EDGE	

SOC_ETM_CH _n _EVT_ID	Selected Event	Peripheral Generating This Event	
10	GPIO_EVT_CH1_FALL_EDGE		
11	GPIO_EVT_CH2_FALL_EDGE		
12	GPIO_EVT_CH3_FALL_EDGE		
13	GPIO_EVT_CH4_FALL_EDGE		
14	GPIO_EVT_CH5_FALL_EDGE		
15	GPIO_EVT_CH6_FALL_EDGE		
16	GPIO_EVT_CH7_FALL_EDGE		
17	GPIO_EVT_CH0_ANY_EDGE		
18	GPIO_EVT_CH1_ANY_EDGE		
19	GPIO_EVT_CH2_ANY_EDGE		
20	GPIO_EVT_CH3_ANY_EDGE		
21	GPIO_EVT_CH4_ANY_EDGE		
22	GPIO_EVT_CH5_ANY_EDGE		
23	GPIO_EVT_CH6_ANY_EDGE		
24	GPIO_EVT_CH7_ANY_EDGE		
25	LEDC_EVT_DUTY_CHNG_END_CH0		LED PWM Controller (LEDC)
26	LEDC_EVT_DUTY_CHNG_END_CH1		
27	LEDC_EVT_DUTY_CHNG_END_CH2		
28	LEDC_EVT_DUTY_CHNG_END_CH3		
29	LEDC_EVT_DUTY_CHNG_END_CH4		
30	LEDC_EVT_DUTY_CHNG_END_CH5		
31	LEDC_EVT_OVF_CNT_PLS_CH0		
32	LEDC_EVT_OVF_CNT_PLS_CH1		
33	LEDC_EVT_OVF_CNT_PLS_CH2		
34	LEDC_EVT_OVF_CNT_PLS_CH3		
35	LEDC_EVT_OVF_CNT_PLS_CH4		
36	LEDC_EVT_OVF_CNT_PLS_CH5		
37	LEDC_EVT_TIME_OVF_TIMER0		
38	LEDC_EVT_TIME_OVF_TIMER1		
39	LEDC_EVT_TIME_OVF_TIMER2		
40	LEDC_EVT_TIME_OVF_TIMER3		
41	LEDC_EVT_TIMER0_CMP		
42	LEDC_EVT_TIMER1_CMP		
43	LEDC_EVT_TIMER2_CMP		
44	LEDC_EVT_TIMER3_CMP		
48	TIMER0_EVT_CNT_CMP_TIMER0	General-purpose timer 0	
49	TIMER1_EVT_CNT_CMP_TIMER0	General-purpose timer 1	
50	SYSTIMER_EVT_CNT_CMP0	System Timer (SYSTIMER)	
51	SYSTIMER_EVT_CNT_CMP1		
52	SYSTIMER_EVT_CNT_CMP2		
58	MCPWM_EVT_TIMER0_STOP	Motor Control PWM (MCPWM)	
59	MCPWM_EVT_TIMER1_STOP		
60	MCPWM_EVT_TIMER2_STOP		
61	MCPWM_EVT_TIMER0_TEZ		
62	MCPWM_EVT_TIMER1_TEZ		

SOC_ETM_CH _n _EVT_ID	Selected Event	Peripheral Generating This Event	
63	MCPWM_EVT_TIMER2_TEZ		
64	MCPWM_EVT_TIMER0_TEP		
65	MCPWM_EVT_TIMER1_TEP		
66	MCPWM_EVT_TIMER2_TEP		
67	MCPWM_EVT_OP0_TEA		
68	MCPWM_EVT_OP1_TEA		
69	MCPWM_EVT_OP2_TEA		
70	MCPWM_EVT_OP0_TEB		
71	MCPWM_EVT_OP1_TEB		
72	MCPWM_EVT_OP2_TEB		
73	MCPWM_EVT_F0		
74	MCPWM_EVT_F1		
75	MCPWM_EVT_F2		
76	MCPWM_EVT_F0_CLR		
77	MCPWM_EVT_F1_CLR		
78	MCPWM_EVT_F2_CLR		
79	MCPWM_EVT_TZ0_CBC		
80	MCPWM_EVT_TZ1_CBC		
81	MCPWM_EVT_TZ2_CBC		
82	MCPWM_EVT_TZ0_OST		
83	MCPWM_EVT_TZ1_OST		
84	MCPWM_EVT_TZ2_OST		
85	MCPWM_EVT_CAP0		
86	MCPWM_EVT_CAP1		
87	MCPWM_EVT_CAP2		
88	ADC_EVT_CONV_CMPLT0		ADC
89	ADC_EVT_EQ_ABOVE_THRESH0		
90	ADC_EVT_EQ_ABOVE_THRESH1		
91	ADC_EVT_EQ_BELOW_THRESH0		
92	ADC_EVT_EQ_BELOW_THRESH1		
94	ADC_EVT_STOPPED0		
95	ADC_EVT_STARTED0		
110	TMPSNSR_EVT_OVER_LIMIT		Temperature Sensor
126	I2S_EVT_RX_DONE		I2S Controller (I2S)
127	I2S_EVT_TX_DONE		
128	I2S_EVT_X_WORDS_RECEIVED		
129	I2S_EVT_X_WORDS_SENT		
133	ULP_EVT_ERR_INTR	Low-Power CPU	
134	ULP_EVT_START_INTR		
135	RTC_EVT_TICK	RTC Watchdog Timer	
136	RTC_EVT_OVF		
137	RTC_EVT_CMP		
138	GDMA_EVT_IN_DONE_CH0	GDMA Controller (GDMA)	
139	GDMA_EVT_IN_DONE_CH1		
140	GDMA_EVT_IN_DONE_CH2		

SOC_ETM_CH n _EVT_ID	Selected Event	Peripheral Generating This Event
141	GDMA_EVT_IN_SUC_EOF_CH0	
142	GDMA_EVT_IN_SUC_EOF_CH1	
143	GDMA_EVT_IN_SUC_EOF_CH2	
144	GDMA_EVT_IN_FIFO_EMPTY_CH0	
145	GDMA_EVT_IN_FIFO_EMPTY_CH1	
146	GDMA_EVT_IN_FIFO_EMPTY_CH2	
147	GDMA_EVT_IN_FIFO_FULL_CH0	
148	GDMA_EVT_IN_FIFO_FULL_CH1	
149	GDMA_EVT_IN_FIFO_FULL_CH2	
150	GDMA_EVT_OUT_DONE_CH0	
151	GDMA_EVT_OUT_DONE_CH1	
152	GDMA_EVT_OUT_DONE_CH2	
153	GDMA_EVT_OUT_EOF_CH0	
154	GDMA_EVT_OUT_EOF_CH1	
155	GDMA_EVT_OUT_EOF_CH2	
156	GDMA_EVT_OUT_TOTAL_EOF_CH0	
157	GDMA_EVT_OUT_TOTAL_EOF_CH1	
158	GDMA_EVT_OUT_TOTAL_EOF_CH2	
159	GDMA_EVT_OUT_FIFO_EMPTY_CH0	
160	GDMA_EVT_OUT_FIFO_EMPTY_CH1	
161	GDMA_EVT_OUT_FIFO_EMPTY_CH2	
162	GDMA_EVT_OUT_FIFO_FULL_CH0	
163	GDMA_EVT_OUT_FIFO_FULL_CH1	
164	GDMA_EVT_OUT_FIFO_FULL_CH2	
165	PMU_EVT_SLEEP_WEEKUP	PMU

Each event corresponds to a pulse signal generated by the corresponding peripheral. When the pulse signal is valid, the corresponding event is considered as received.

For more detailed descriptions of an event, please refer to the chapter for the peripheral generating this event.

11.3.3 Tasks

An ETM channel can be set up to map its event to one of the tasks by configuring the `SOC_ETM_CH n _TASK_ID` field. Table 11-2 shows the configuration values of `SOC_ETM_CH n _TASK_ID` and their corresponding tasks.

Table 11-2. Mappable Tasks for ETM Channel n

SOC_ETM_CH n _TASK_ID	Mapped Task	Peripheral Receiving This Task
1	GPIO_TASK_CH0_SET	GPIO
2	GPIO_TASK_CH1_SET	
3	GPIO_TASK_CH2_SET	
4	GPIO_TASK_CH3_SET	
5	GPIO_TASK_CH4_SET	

SOC_ETM_CH _n _TASK_ID	Mapped Task	Peripheral Receiving This Task	
6	GPIO_TASK_CH5_SET		
7	GPIO_TASK_CH6_SET		
8	GPIO_TASK_CH7_SET		
9	GPIO_TASK_CH0_CLEAR		
10	GPIO_TASK_CH1_CLEAR		
11	GPIO_TASK_CH2_CLEAR		
12	GPIO_TASK_CH3_CLEAR		
13	GPIO_TASK_CH4_CLEAR		
14	GPIO_TASK_CH5_CLEAR		
15	GPIO_TASK_CH6_CLEAR		
16	GPIO_TASK_CH7_CLEAR		
17	GPIO_TASK_CH0_TOGGLE		
18	GPIO_TASK_CH1_TOGGLE		
19	GPIO_TASK_CH2_TOGGLE		
20	GPIO_TASK_CH3_TOGGLE		
21	GPIO_TASK_CH4_TOGGLE		
22	GPIO_TASK_CH5_TOGGLE		
23	GPIO_TASK_CH6_TOGGLE		
24	GPIO_TASK_CH7_TOGGLE		
25	LEDC_TASK_TIMER0_RES_UPDATE		LED PWM Controller (LEDC)
26	LEDC_TASK_TIMER1_RES_UPDATE		
27	LEDC_TASK_TIMER2_RES_UPDATE		
28	LEDC_TASK_TIMER3_RES_UPDATE		
31	LEDC_TASK_DUTY_SCALE_UPDATE_CH0		
32	LEDC_TASK_DUTY_SCALE_UPDATE_CH1		
33	LEDC_TASK_DUTY_SCALE_UPDATE_CH2		
34	LEDC_TASK_DUTY_SCALE_UPDATE_CH3		
35	LEDC_TASK_DUTY_SCALE_UPDATE_CH4		
36	LEDC_TASK_DUTY_SCALE_UPDATE_CH5		
37	LEDC_TASK_TIMER0_CAP		
38	LEDC_TASK_TIMER1_CAP		
39	LEDC_TASK_TIMER2_CAP		
40	LEDC_TASK_TIMER3_CAP		
41	LEDC_TASK_SIG_OUT_DIS_CH0		
42	LEDC_TASK_SIG_OUT_DIS_CH1		
43	LEDC_TASK_SIG_OUT_DIS_CH2		
44	LEDC_TASK_SIG_OUT_DIS_CH3		
45	LEDC_TASK_SIG_OUT_DIS_CH4		
46	LEDC_TASK_SIG_OUT_DIS_CH5		
47	LEDC_TASK_OVF_CNT_RST_CH0		
48	LEDC_TASK_OVF_CNT_RST_CH1		
49	LEDC_TASK_OVF_CNT_RST_CH2		
50	LEDC_TASK_OVF_CNT_RST_CH3		
51	LEDC_TASK_OVF_CNT_RST_CH4		
52	LEDC_TASK_OVF_CNT_RST_CH5		

SOC_ETM_CH _n _TASK_ID	Mapped Task	Peripheral Receiving This Task
53	LEDC_TASK_TIMER0_RST	
54	LEDC_TASK_TIMER1_RST	
55	LEDC_TASK_TIMER2_RST	
56	LEDC_TASK_TIMER3_RST	
57	LEDC_TASK_TIMER0_RESUME	
58	LEDC_TASK_TIMER1_RESUME	
59	LEDC_TASK_TIMER2_RESUME	
60	LEDC_TASK_TIMER3_RESUME	
61	LEDC_TASK_TIMER0_PAUSE	
62	LEDC_TASK_TIMER1_PAUSE	
63	LEDC_TASK_TIMER2_PAUSE	
64	LEDC_TASK_TIMER3_PAUSE	
65	LEDC_TASK_GAMMA_RESTART_CH0	
66	LEDC_TASK_GAMMA_RESTART_CH1	
67	LEDC_TASK_GAMMA_RESTART_CH2	
68	LEDC_TASK_GAMMA_RESTART_CH3	
69	LEDC_TASK_GAMMA_RESTART_CH4	
70	LEDC_TASK_GAMMA_RESTART_CH5	
71	LEDC_TASK_GAMMA_PAUSE_CH0	
72	LEDC_TASK_GAMMA_PAUSE_CH1	
73	LEDC_TASK_GAMMA_PAUSE_CH2	
74	LEDC_TASK_GAMMA_PAUSE_CH3	
75	LEDC_TASK_GAMMA_PAUSE_CH4	
76	LEDC_TASK_GAMMA_PAUSE_CH5	
77	LEDC_TASK_GAMMA_RESUME_CH0	
78	LEDC_TASK_GAMMA_RESUME_CH1	
79	LEDC_TASK_GAMMA_RESUME_CH2	
80	LEDC_TASK_GAMMA_RESUME_CH3	
81	LEDC_TASK_GAMMA_RESUME_CH4	
82	LEDC_TASK_GAMMA_RESUME_CH5	
88	TIMER0_TASK_CNT_START_TIMER0	General-purpose timer 0
90	TIMER0_TASK_ALARM_START_TIMER0	
92	TIMER0_TASK_CNT_STOP_TIMER0	
94	TIMER0_TASK_CNT_RELOAD_TIMER0	
96	TIMER0_TASK_CNT_CAP_TIMER0	
89	TIMER1_TASK_CNT_START_TIMER0	General-purpose timer 1
91	TIMER1_TASK_ALARM_START_TIMER0	
93	TIMER1_TASK_CNT_STOP_TIMER0	
95	TIMER1_TASK_CNT_RELOAD_TIMER0	
97	TIMER1_TASK_CNT_CAP_TIMER0	
102	MCPWM_TASK_CMPR0_A_UP	Motor Control PWM (MCPWM)
103	MCPWM_TASK_CMPR1_A_UP	
104	MCPWM_TASK_CMPR2_A_UP	
105	MCPWM_TASK_CMPR0_B_UP	
106	MCPWM_TASK_CMPR1_B_UP	

SOC_ETM_CH n _TASK_ID	Mapped Task	Peripheral Receiving This Task	
107	MCPWM_TASK_CMPR2_B_UP		
108	MCPWM_TASK_GEN_STOP		
109	MCPWM_TASK_TIMER0_SYN		
110	MCPWM_TASK_TIMER1_SYN		
111	MCPWM_TASK_TIMER2_SYN		
112	MCPWM_TASK_TIMER0_PERIOD_UP		
113	MCPWM_TASK_TIMER1_PERIOD_UP		
114	MCPWM_TASK_TIMER2_PERIOD_UP		
115	MCPWM_TASK_TZ0_OST		
116	MCPWM_TASK_TZ1_OST		
117	MCPWM_TASK_TZ2_OST		
118	MCPWM_TASK_CLR0_OST		
119	MCPWM_TASK_CLR1_OST		
120	MCPWM_TASK_CLR2_OST		
121	MCPWM_TASK_CAP0		
122	MCPWM_TASK_CAP1		
123	MCPWM_TASK_CAP2		
124	ADC_TASK_SAMPLE0		ADC
125	ADC_TASK_SAMPLE1		
126	ADC_TASK_START0		
127	ADC_TASK_STOP0		
135	TMPSNSR_TASK_START_SAMPLE		Temperature Sensor
136	TMPSNSR_TASK_STOP_SAMPLE		
148	I2S_TASK_START_RX	I2S Controller (I2S)	
149	I2S_TASK_START_TX		
150	I2S_TASK_STOP_RX		
151	I2S_TASK_STOP_TX		
154	ULP_TASK_WEAKUP_CPU	Low-Power CPU	
159	GDMA_TASK_IN_START_CH0	GDMA Controller (GDMA)	
160	GDMA_TASK_IN_START_CH1		
161	GDMA_TASK_IN_START_CH2		
162	GDMA_TASK_OUT_START_CH0		
163	GDMA_TASK_OUT_START_CH1		
164	GDMA_TASK_OUT_START_CH2		
165	PMU_TASK_SLEEP_REQ	PMU	

When a channel receives a valid event pulse signal, it generates the mapped task pulse signal.

For more detailed descriptions of a task, please refer to the chapter for the peripheral receiving this task.

Events from different channels can be optionally mapped to the same task (For example, field [SOC_ETM_CH \$n\$ _TASK_ID](#) of multiple channels can be configured with the same value, and field [SOC_ETM_CH \$n\$ _EVT_ID](#) can be configured with the same or different values). In this case, when the event received by any of the channels is valid, the task is generated. If events received by multiple channels are valid at the same time, the task will be generated only once.

11.3.4 Timing Considerations

Figure 11-3 shows the structure of clocks that drive received events, sent tasks, and ETM channels.

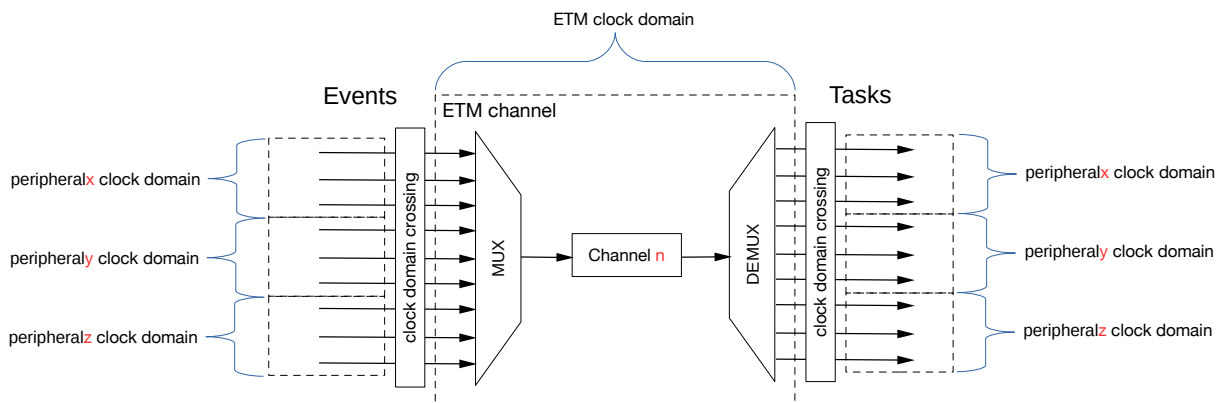

Figure 11-3. Event Task Matrix Clock Architecture

ETM is running at the AHB_CLK domain (see Chapter 8 *Reset and Clock*). Each event corresponds to a pulse signal generated by the corresponding peripheral in its clock domain, while each task is mapped by the ETM to a pulse signal under its corresponding peripheral clock domain. The peripherals generating events, the Event Task Matrix, and peripherals receiving tasks are not necessarily running off the same clock and as such need to be synchronized. Therefore, there must be a minimum interval between two consecutive events to avoid event loss: to make sure the Event Task Matrix receives every event successfully, for peripherals generating event pulses, the interval between two consecutive pulses must be greater than one ETM clock cycle, namely $\text{ceil}(\frac{\text{peripheral_clock_frequency}}{\text{ETM_clock_frequency}})$ in the unit of peripheral clock cycles.

For example, assuming that event 1 generated by peripheral A is in the 80 MHz clock domain (PLL_F80M_CLK), and the ETM runs in the 40 MHz clock domain (AHB_CLK). To receive each event 1 successfully, the interval between two consecutive event 1 must be greater than two peripheral A clock cycles (i.e. one ETM clock cycle).

Likewise, to make sure the Event Task Matrix maps the received event (i.e. event synchronized to the ETM's clock domain) successfully to a task, the interval between two consecutive event pulses in the ETM clock domain must be greater than one peripheral clock cycle, namely $\text{ceil}(\frac{\text{ETM_clock_frequency}}{\text{peripheral_clock_frequency}})$ in the unit of ETM clock cycles.

For example, assuming that task 1 received by peripheral B is in the 20 MHz clock domain (RC_FAST_CLK), and the ETM runs in the 40 MHz clock domain (AHB_CLK). To map each received event successfully to task 1, the interval between two consecutive events must be greater than two ETM clock cycles (i.e. one peripheral B clock cycle).

As a result, to map two consecutive events generated by peripheral A to peripheral B, the interval between these two events must be $\text{ceil}(\frac{\text{peripheral_A_clock_frequency}}{\text{ETM_clock_frequency}}) * \text{ceil}(\frac{\text{ETM_clock_frequency}}{\text{peripheral_B_clock_frequency}})$ in the unit of peripheral A clock cycles.

For example, assuming that event 1 generated by peripheral A is in the 80 MHz clock domain (PLL_F80M_CLK), task 1 received by peripheral B is in the 20 MHz clock domain (RC_FAST_CLK), and the ETM runs in the 40 MHz clock domain (AHB_CLK). To successfully map each event 1 (generated by peripheral A) to task 1 (received by

peripheral B), the interval between two consecutive event 1 must be greater than $2 * 2 = 4$ peripheral A clock cycles.

11.3.5 Channel Control

Each ETM channel can be independently configured to be enabled or disabled. When channel n is enabled and receives the event configured via `SOC_ETM_CH n _EVT_ID`, it maps the event to the task configured via `SOC_ETM_CH n _TASK_ID`. When channel n is disabled, even if it receives the configured via `SOC_ETM_CH n _EVT_ID`, no task will be generated.

To enable ETM channel n :

1. Write 1 to `SOC_ETM_CH_ENABLE n`
2. Read `SOC_ETM_CH_ENABLED n` . 1 indicates that channel n has been enabled, and 0 indicates disabled

To disable ETM channel n :

1. Write 1 to `SOC_ETM_CH_DISABLE n`
2. Read `SOC_ETM_CH_ENABLED n` . 0 indicates that channel n is disabled, and 1 indicates enabled

If `SOC_ETM_CH n _EVT_ID` or `SOC_ETM_CH n _TASK_ID` is configured to 0, ETM channel n will also be disabled.

The complete procedure to configure ETM channel n is as follows:

1. Enable the ETM's clock by writing 1 to `PCR_ETM_CLK_EN`
2. Select the event to be received by channel n via `SOC_ETM_CH n _EVT_ID`
3. Select the task mapped to the received event via `SOC_ETM_CH n _TASK_ID`
4. Write 1 to field `SOC_ETM_CH_ENABLE n`
5. When channel n no longer needs to map the selected event to the selected task, disable channel n by setting `SOC_ETM_CH_DISABLE n` . To configure a new event and task mapping, repeat Steps 1 to 3. If no configurations, channel n will remain disabled
6. The ETM module can be reset by writing 0 and then 1 to the `PCR_ETM_RST_EN` field

11.4 Register Summary

The addresses in this section are relative to Event Task Matrix base address provided in Table 5-2 in Chapter 5 *System and Memory*.

The abbreviations given in Column **Access** are explained in Section *Access Types for Registers*.

Name	Description	Address	Access
Configuration Register			
SOC_ETM_CH_ENA_AD0_REG	Channel status register	0x0000	R/WTC/WTS
SOC_ETM_CH_ENA_AD0_SET_REG	Channel enable register	0x0004	WT
SOC_ETM_CH_ENA_AD0_CLR_REG	Channel disable register	0x0008	WT
SOC_ETM_CH_ENA_AD1_REG	Channel status register	0x000C	R/WTC/WTS
SOC_ETM_CH_ENA_AD1_SET_REG	Channel enable register	0x0010	WT
SOC_ETM_CH_ENA_AD1_CLR_REG	Channel disable register	0x0014	WT
SOC_ETM_CH0_EVT_ID_REG	Channel0 event ID register	0x0018	R/W
SOC_ETM_CH0_TASK_ID_REG	Channel0 task ID register	0x001C	R/W
SOC_ETM_CH1_EVT_ID_REG	Channel1 event ID register	0x0020	R/W
SOC_ETM_CH1_TASK_ID_REG	Channel1 task ID register	0x0024	R/W
SOC_ETM_CH2_EVT_ID_REG	Channel2 event ID register	0x0028	R/W
SOC_ETM_CH2_TASK_ID_REG	Channel2 task ID register	0x002C	R/W
SOC_ETM_CH3_EVT_ID_REG	Channel3 event ID register	0x0030	R/W
SOC_ETM_CH3_TASK_ID_REG	Channel3 task ID register	0x0034	R/W
SOC_ETM_CH4_EVT_ID_REG	Channel4 event ID register	0x0038	R/W
SOC_ETM_CH4_TASK_ID_REG	Channel4 task ID register	0x003C	R/W
SOC_ETM_CH5_EVT_ID_REG	Channel5 event ID register	0x0040	R/W
SOC_ETM_CH5_TASK_ID_REG	Channel5 task ID register	0x0044	R/W
SOC_ETM_CH6_EVT_ID_REG	Channel6 event ID register	0x0048	R/W
SOC_ETM_CH6_TASK_ID_REG	Channel6 task ID register	0x004C	R/W
SOC_ETM_CH7_EVT_ID_REG	Channel7 event ID register	0x0050	R/W
SOC_ETM_CH7_TASK_ID_REG	Channel7 task ID register	0x0054	R/W
SOC_ETM_CH8_EVT_ID_REG	Channel8 event ID register	0x0058	R/W
SOC_ETM_CH8_TASK_ID_REG	Channel8 task ID register	0x005C	R/W
SOC_ETM_CH9_EVT_ID_REG	Channel9 event ID register	0x0060	R/W
SOC_ETM_CH9_TASK_ID_REG	Channel9 task ID register	0x0064	R/W
SOC_ETM_CH10_EVT_ID_REG	Channel10 event ID register	0x0068	R/W
SOC_ETM_CH10_TASK_ID_REG	Channel10 task ID register	0x006C	R/W
SOC_ETM_CH11_EVT_ID_REG	Channel11 event ID register	0x0070	R/W
SOC_ETM_CH11_TASK_ID_REG	Channel11 task ID register	0x0074	R/W
SOC_ETM_CH12_EVT_ID_REG	Channel12 event ID register	0x0078	R/W
SOC_ETM_CH12_TASK_ID_REG	Channel12 task ID register	0x007C	R/W
SOC_ETM_CH13_EVT_ID_REG	Channel13 event ID register	0x0080	R/W
SOC_ETM_CH13_TASK_ID_REG	Channel13 task ID register	0x0084	R/W
SOC_ETM_CH14_EVT_ID_REG	Channel14 event ID register	0x0088	R/W
SOC_ETM_CH14_TASK_ID_REG	Channel14 task ID register	0x008C	R/W
SOC_ETM_CH15_EVT_ID_REG	Channel15 event ID register	0x0090	R/W

Name	Description	Address	Access
SOC_ETM_CH15_TASK_ID_REG	Channel15 task ID register	0x0094	R/W
SOC_ETM_CH16_EVT_ID_REG	Channel16 event ID register	0x0098	R/W
SOC_ETM_CH16_TASK_ID_REG	Channel16 task ID register	0x009C	R/W
SOC_ETM_CH17_EVT_ID_REG	Channel17 event ID register	0x00A0	R/W
SOC_ETM_CH17_TASK_ID_REG	Channel17 task ID register	0x00A4	R/W
SOC_ETM_CH18_EVT_ID_REG	Channel18 event ID register	0x00A8	R/W
SOC_ETM_CH18_TASK_ID_REG	Channel18 task ID register	0x00AC	R/W
SOC_ETM_CH19_EVT_ID_REG	Channel19 event ID register	0x00B0	R/W
SOC_ETM_CH19_TASK_ID_REG	Channel19 task ID register	0x00B4	R/W
SOC_ETM_CH20_EVT_ID_REG	Channel20 event ID register	0x00B8	R/W
SOC_ETM_CH20_TASK_ID_REG	Channel20 task ID register	0x00BC	R/W
SOC_ETM_CH21_EVT_ID_REG	Channel21 event ID register	0x00C0	R/W
SOC_ETM_CH21_TASK_ID_REG	Channel21 task ID register	0x00C4	R/W
SOC_ETM_CH22_EVT_ID_REG	Channel22 event ID register	0x00C8	R/W
SOC_ETM_CH22_TASK_ID_REG	Channel22 task ID register	0x00CC	R/W
SOC_ETM_CH23_EVT_ID_REG	Channel23 event ID register	0x00D0	R/W
SOC_ETM_CH23_TASK_ID_REG	Channel23 task ID register	0x00D4	R/W
SOC_ETM_CH24_EVT_ID_REG	Channel24 event ID register	0x00D8	R/W
SOC_ETM_CH24_TASK_ID_REG	Channel24 task ID register	0x00DC	R/W
SOC_ETM_CH25_EVT_ID_REG	Channel25 event ID register	0x00E0	R/W
SOC_ETM_CH25_TASK_ID_REG	Channel25 task ID register	0x00E4	R/W
SOC_ETM_CH26_EVT_ID_REG	Channel26 event ID register	0x00E8	R/W
SOC_ETM_CH26_TASK_ID_REG	Channel26 task ID register	0x00EC	R/W
SOC_ETM_CH27_EVT_ID_REG	Channel27 event ID register	0x00F0	R/W
SOC_ETM_CH27_TASK_ID_REG	Channel27 task ID register	0x00F4	R/W
SOC_ETM_CH28_EVT_ID_REG	Channel28 event ID register	0x00F8	R/W
SOC_ETM_CH28_TASK_ID_REG	Channel28 task ID register	0x00FC	R/W
SOC_ETM_CH29_EVT_ID_REG	Channel29 event ID register	0x0100	R/W
SOC_ETM_CH29_TASK_ID_REG	Channel29 task ID register	0x0104	R/W
SOC_ETM_CH30_EVT_ID_REG	Channel30 event ID register	0x0108	R/W
SOC_ETM_CH30_TASK_ID_REG	Channel30 task ID register	0x010C	R/W
SOC_ETM_CH31_EVT_ID_REG	Channel31 event ID register	0x0110	R/W
SOC_ETM_CH31_TASK_ID_REG	Channel31 task ID register	0x0114	R/W
SOC_ETM_CH32_EVT_ID_REG	Channel32 event ID register	0x0118	R/W
SOC_ETM_CH32_TASK_ID_REG	Channel32 task ID register	0x011C	R/W
SOC_ETM_CH33_EVT_ID_REG	Channel33 event ID register	0x0120	R/W
SOC_ETM_CH33_TASK_ID_REG	Channel33 task ID register	0x0124	R/W
SOC_ETM_CH34_EVT_ID_REG	Channel34 event ID register	0x0128	R/W
SOC_ETM_CH34_TASK_ID_REG	Channel34 task ID register	0x012C	R/W
SOC_ETM_CH35_EVT_ID_REG	Channel35 event ID register	0x0130	R/W
SOC_ETM_CH35_TASK_ID_REG	Channel35 task ID register	0x0134	R/W
SOC_ETM_CH36_EVT_ID_REG	Channel36 event ID register	0x0138	R/W
SOC_ETM_CH36_TASK_ID_REG	Channel36 task ID register	0x013C	R/W

Name	Description	Address	Access
SOC_ETM_CH37_EVT_ID_REG	Channel37 event ID register	0x0140	R/W
SOC_ETM_CH37_TASK_ID_REG	Channel37 task ID register	0x0144	R/W
SOC_ETM_CH38_EVT_ID_REG	Channel38 event ID register	0x0148	R/W
SOC_ETM_CH38_TASK_ID_REG	Channel38 task ID register	0x014C	R/W
SOC_ETM_CH39_EVT_ID_REG	Channel39 event ID register	0x0150	R/W
SOC_ETM_CH39_TASK_ID_REG	Channel39 task ID register	0x0154	R/W
SOC_ETM_CH40_EVT_ID_REG	Channel40 event ID register	0x0158	R/W
SOC_ETM_CH40_TASK_ID_REG	Channel40 task ID register	0x015C	R/W
SOC_ETM_CH41_EVT_ID_REG	Channel41 event ID register	0x0160	R/W
SOC_ETM_CH41_TASK_ID_REG	Channel41 task ID register	0x0164	R/W
SOC_ETM_CH42_EVT_ID_REG	Channel42 event ID register	0x0168	R/W
SOC_ETM_CH42_TASK_ID_REG	Channel42 task ID register	0x016C	R/W
SOC_ETM_CH43_EVT_ID_REG	Channel43 event ID register	0x0170	R/W
SOC_ETM_CH43_TASK_ID_REG	Channel43 task ID register	0x0174	R/W
SOC_ETM_CH44_EVT_ID_REG	Channel44 event ID register	0x0178	R/W
SOC_ETM_CH44_TASK_ID_REG	Channel44 task ID register	0x017C	R/W
SOC_ETM_CH45_EVT_ID_REG	Channel45 event ID register	0x0180	R/W
SOC_ETM_CH45_TASK_ID_REG	Channel45 task ID register	0x0184	R/W
SOC_ETM_CH46_EVT_ID_REG	Channel46 event ID register	0x0188	R/W
SOC_ETM_CH46_TASK_ID_REG	Channel46 task ID register	0x018C	R/W
SOC_ETM_CH47_EVT_ID_REG	Channel47 event ID register	0x0190	R/W
SOC_ETM_CH47_TASK_ID_REG	Channel47 task ID register	0x0194	R/W
SOC_ETM_CH48_EVT_ID_REG	Channel48 event ID register	0x0198	R/W
SOC_ETM_CH48_TASK_ID_REG	Channel48 task ID register	0x019C	R/W
SOC_ETM_CH49_EVT_ID_REG	Channel49 event ID register	0x01A0	R/W
SOC_ETM_CH49_TASK_ID_REG	Channel49 task ID register	0x01A4	R/W
SOC_ETM_CLK_EN_REG	ETM clock enable register	0x01A8	R/W
Version Register			
SOC_ETM_DATE_REG	Version control register	0x01AC	R/W

11.5 Registers

The addresses in this section are relative to Event Task Matrix base address provided in Table 5-2 in Chapter 5 *System and Memory*.

Register 11.1. SOC_ETM_CH_ENA_AD0_REG (0x0000)

<div style="display: flex; justify-content: space-between;"> <div style="writing-mode: vertical-rl; transform: rotate(180deg);">SOC_ETM_CH_ENABLED31</div> <div style="writing-mode: vertical-rl; transform: rotate(180deg);">SOC_ETM_CH_ENABLED30</div> <div style="writing-mode: vertical-rl; transform: rotate(180deg);">SOC_ETM_CH_ENABLED29</div> <div style="writing-mode: vertical-rl; transform: rotate(180deg);">SOC_ETM_CH_ENABLED28</div> <div style="writing-mode: vertical-rl; transform: rotate(180deg);">SOC_ETM_CH_ENABLED27</div> <div style="writing-mode: vertical-rl; transform: rotate(180deg);">SOC_ETM_CH_ENABLED26</div> <div style="writing-mode: vertical-rl; transform: rotate(180deg);">SOC_ETM_CH_ENABLED25</div> <div style="writing-mode: vertical-rl; transform: rotate(180deg);">SOC_ETM_CH_ENABLED24</div> <div style="writing-mode: vertical-rl; transform: rotate(180deg);">SOC_ETM_CH_ENABLED23</div> <div style="writing-mode: vertical-rl; transform: rotate(180deg);">SOC_ETM_CH_ENABLED22</div> <div style="writing-mode: vertical-rl; transform: rotate(180deg);">SOC_ETM_CH_ENABLED21</div> <div style="writing-mode: vertical-rl; transform: rotate(180deg);">SOC_ETM_CH_ENABLED20</div> <div style="writing-mode: vertical-rl; transform: rotate(180deg);">SOC_ETM_CH_ENABLED19</div> <div style="writing-mode: vertical-rl; transform: rotate(180deg);">SOC_ETM_CH_ENABLED18</div> <div style="writing-mode: vertical-rl; transform: rotate(180deg);">SOC_ETM_CH_ENABLED17</div> <div style="writing-mode: vertical-rl; transform: rotate(180deg);">SOC_ETM_CH_ENABLED16</div> <div style="writing-mode: vertical-rl; transform: rotate(180deg);">SOC_ETM_CH_ENABLED15</div> <div style="writing-mode: vertical-rl; transform: rotate(180deg);">SOC_ETM_CH_ENABLED14</div> <div style="writing-mode: vertical-rl; transform: rotate(180deg);">SOC_ETM_CH_ENABLED13</div> <div style="writing-mode: vertical-rl; transform: rotate(180deg);">SOC_ETM_CH_ENABLED12</div> <div style="writing-mode: vertical-rl; transform: rotate(180deg);">SOC_ETM_CH_ENABLED11</div> <div style="writing-mode: vertical-rl; transform: rotate(180deg);">SOC_ETM_CH_ENABLED10</div> <div style="writing-mode: vertical-rl; transform: rotate(180deg);">SOC_ETM_CH_ENABLED9</div> <div style="writing-mode: vertical-rl; transform: rotate(180deg);">SOC_ETM_CH_ENABLED8</div> <div style="writing-mode: vertical-rl; transform: rotate(180deg);">SOC_ETM_CH_ENABLED7</div> <div style="writing-mode: vertical-rl; transform: rotate(180deg);">SOC_ETM_CH_ENABLED6</div> <div style="writing-mode: vertical-rl; transform: rotate(180deg);">SOC_ETM_CH_ENABLED5</div> <div style="writing-mode: vertical-rl; transform: rotate(180deg);">SOC_ETM_CH_ENABLED4</div> <div style="writing-mode: vertical-rl; transform: rotate(180deg);">SOC_ETM_CH_ENABLED3</div> <div style="writing-mode: vertical-rl; transform: rotate(180deg);">SOC_ETM_CH_ENABLED2</div> <div style="writing-mode: vertical-rl; transform: rotate(180deg);">SOC_ETM_CH_ENABLED1</div> <div style="writing-mode: vertical-rl; transform: rotate(180deg);">SOC_ETM_CH_ENABLED0</div> </div>																																	
31	30	29	28	27	26	25	24	23	22	21	20	19	18	17	16	15	14	13	12	11	10	9	8	7	6	5	4	3	2	1	0		
0	0	0	0	0	0	0	0	0	0	0	0	0	0	0	0	0	0	0	0	0	0	0	0	0	0	0	0	0	0	0	0	0	Reset

SOC_ETM_CH_ENABLED n (n : 0-31) Represents the status of channel n .

- 0: Disabled
- 1: Enabled
- (R/WTC/SS)

Register 11.2. SOC_ETM_CH_ENA_AD0_SET_REG (0x0004)

<div style="display: flex; justify-content: space-between;"> <div style="writing-mode: vertical-rl; transform: rotate(180deg);">SOC_ETM_CH_ENABLE31</div> <div style="writing-mode: vertical-rl; transform: rotate(180deg);">SOC_ETM_CH_ENABLE30</div> <div style="writing-mode: vertical-rl; transform: rotate(180deg);">SOC_ETM_CH_ENABLE29</div> <div style="writing-mode: vertical-rl; transform: rotate(180deg);">SOC_ETM_CH_ENABLE28</div> <div style="writing-mode: vertical-rl; transform: rotate(180deg);">SOC_ETM_CH_ENABLE27</div> <div style="writing-mode: vertical-rl; transform: rotate(180deg);">SOC_ETM_CH_ENABLE26</div> <div style="writing-mode: vertical-rl; transform: rotate(180deg);">SOC_ETM_CH_ENABLE25</div> <div style="writing-mode: vertical-rl; transform: rotate(180deg);">SOC_ETM_CH_ENABLE24</div> <div style="writing-mode: vertical-rl; transform: rotate(180deg);">SOC_ETM_CH_ENABLE23</div> <div style="writing-mode: vertical-rl; transform: rotate(180deg);">SOC_ETM_CH_ENABLE22</div> <div style="writing-mode: vertical-rl; transform: rotate(180deg);">SOC_ETM_CH_ENABLE21</div> <div style="writing-mode: vertical-rl; transform: rotate(180deg);">SOC_ETM_CH_ENABLE20</div> <div style="writing-mode: vertical-rl; transform: rotate(180deg);">SOC_ETM_CH_ENABLE19</div> <div style="writing-mode: vertical-rl; transform: rotate(180deg);">SOC_ETM_CH_ENABLE18</div> <div style="writing-mode: vertical-rl; transform: rotate(180deg);">SOC_ETM_CH_ENABLE17</div> <div style="writing-mode: vertical-rl; transform: rotate(180deg);">SOC_ETM_CH_ENABLE16</div> <div style="writing-mode: vertical-rl; transform: rotate(180deg);">SOC_ETM_CH_ENABLE15</div> <div style="writing-mode: vertical-rl; transform: rotate(180deg);">SOC_ETM_CH_ENABLE14</div> <div style="writing-mode: vertical-rl; transform: rotate(180deg);">SOC_ETM_CH_ENABLE13</div> <div style="writing-mode: vertical-rl; transform: rotate(180deg);">SOC_ETM_CH_ENABLE12</div> <div style="writing-mode: vertical-rl; transform: rotate(180deg);">SOC_ETM_CH_ENABLE11</div> <div style="writing-mode: vertical-rl; transform: rotate(180deg);">SOC_ETM_CH_ENABLE10</div> <div style="writing-mode: vertical-rl; transform: rotate(180deg);">SOC_ETM_CH_ENABLE9</div> <div style="writing-mode: vertical-rl; transform: rotate(180deg);">SOC_ETM_CH_ENABLE8</div> <div style="writing-mode: vertical-rl; transform: rotate(180deg);">SOC_ETM_CH_ENABLE7</div> <div style="writing-mode: vertical-rl; transform: rotate(180deg);">SOC_ETM_CH_ENABLE6</div> <div style="writing-mode: vertical-rl; transform: rotate(180deg);">SOC_ETM_CH_ENABLE5</div> <div style="writing-mode: vertical-rl; transform: rotate(180deg);">SOC_ETM_CH_ENABLE4</div> <div style="writing-mode: vertical-rl; transform: rotate(180deg);">SOC_ETM_CH_ENABLE3</div> <div style="writing-mode: vertical-rl; transform: rotate(180deg);">SOC_ETM_CH_ENABLE2</div> <div style="writing-mode: vertical-rl; transform: rotate(180deg);">SOC_ETM_CH_ENABLE1</div> <div style="writing-mode: vertical-rl; transform: rotate(180deg);">SOC_ETM_CH_ENABLE0</div> </div>																																
31	30	29	28	27	26	25	24	23	22	21	20	19	18	17	16	15	14	13	12	11	10	9	8	7	6	5	4	3	2	1	0	
0	0	0	0	0	0	0	0	0	0	0	0	0	0	0	0	0	0	0	0	0	0	0	0	0	0	0	0	0	0	0	0	Reset

SOC_ETM_CH_ENABLE n (n : 0-31) Configures whether to enable channel n .

- 0: Invalid. No effect
- 1: Enable
- (WT)

Register 11.3. SOC_ETM_CH_ENA_AD0_CLR_REG (0x0008)

(reserved)																		SOC_ETM_CH_DISABLE31 SOC_ETM_CH_DISABLE30 SOC_ETM_CH_DISABLE29 SOC_ETM_CH_DISABLE28 SOC_ETM_CH_DISABLE27 SOC_ETM_CH_DISABLE26 SOC_ETM_CH_DISABLE25 SOC_ETM_CH_DISABLE24 SOC_ETM_CH_DISABLE23 SOC_ETM_CH_DISABLE22 SOC_ETM_CH_DISABLE21 SOC_ETM_CH_DISABLE20 SOC_ETM_CH_DISABLE19 SOC_ETM_CH_DISABLE18 SOC_ETM_CH_DISABLE17 SOC_ETM_CH_DISABLE16 SOC_ETM_CH_DISABLE15 SOC_ETM_CH_DISABLE14 SOC_ETM_CH_DISABLE13 SOC_ETM_CH_DISABLE12 SOC_ETM_CH_DISABLE11 SOC_ETM_CH_DISABLE10 SOC_ETM_CH_DISABLE9 SOC_ETM_CH_DISABLE8 SOC_ETM_CH_DISABLE7 SOC_ETM_CH_DISABLE6 SOC_ETM_CH_DISABLE5 SOC_ETM_CH_DISABLE4 SOC_ETM_CH_DISABLE3 SOC_ETM_CH_DISABLE2 SOC_ETM_CH_DISABLE1																	
31	30	29	28	27	26	25	24	23	22	21	20	19	18	17	16	15	14	13	12	11	10	9	8	7	6	5	4	3	2	1	0	Reset			
0	0	0	0	0	0	0	0	0	0	0	0	0	0	0	0	0	0	0	0	0	0	0	0	0	0	0	0	0	0	0	0	0	0	0	0

SOC_ETM_CH_DISABLE n (n : 0-31) Configures whether to disable channel 0.

- 0: Invalid. No effect
 - 1: Disable
- (WT)

Register 11.4. SOC_ETM_CH_ENA_AD1_REG (0x000C)

(reserved)																		SOC_ETM_CH_ENABLED49 SOC_ETM_CH_ENABLED48 SOC_ETM_CH_ENABLED47 SOC_ETM_CH_ENABLED46 SOC_ETM_CH_ENABLED45 SOC_ETM_CH_ENABLED44 SOC_ETM_CH_ENABLED43 SOC_ETM_CH_ENABLED42 SOC_ETM_CH_ENABLED41 SOC_ETM_CH_ENABLED40 SOC_ETM_CH_ENABLED39 SOC_ETM_CH_ENABLED38 SOC_ETM_CH_ENABLED37 SOC_ETM_CH_ENABLED36 SOC_ETM_CH_ENABLED35 SOC_ETM_CH_ENABLED34 SOC_ETM_CH_ENABLED33 SOC_ETM_CH_ENABLED32																				
31																		18	17	16	15	14	13	12	11	10	9	8	7	6	5	4	3	2	1	0	Reset	
0	0	0	0	0	0	0	0	0	0	0	0	0	0	0	0	0	0	0	0	0	0	0	0	0	0	0	0	0	0	0	0	0	0	0				

SOC_ETM_CH_ENABLED n (n : 32-49) Represents the status of channel n .

- 0: Disabled
 - 1: Enabled
- (R/WTC/SS)

Register 11.5. SOC_ETM_CH_ENA_AD1_SET_REG (0x0010)

(reserved)																		SOC_ETM_CH_ENABLE49 SOC_ETM_CH_ENABLE48 SOC_ETM_CH_ENABLE47 SOC_ETM_CH_ENABLE46 SOC_ETM_CH_ENABLE45 SOC_ETM_CH_ENABLE44 SOC_ETM_CH_ENABLE43 SOC_ETM_CH_ENABLE42 SOC_ETM_CH_ENABLE41 SOC_ETM_CH_ENABLE40 SOC_ETM_CH_ENABLE39 SOC_ETM_CH_ENABLE38 SOC_ETM_CH_ENABLE37 SOC_ETM_CH_ENABLE36 SOC_ETM_CH_ENABLE35 SOC_ETM_CH_ENABLE34 SOC_ETM_CH_ENABLE33 SOC_ETM_CH_ENABLE32																				
31																		18	17	16	15	14	13	12	11	10	9	8	7	6	5	4	3	2	1	0	Reset	
0	0	0	0	0	0	0	0	0	0	0	0	0	0	0	0	0	0	0	0	0	0	0	0	0	0	0	0	0	0	0	0	0	0	0				

SOC_ETM_CH_ENABLE n (n : 32-49) Configures whether to enable channel n .

- 0: Invalid. No effect
 - 1: Enable
- (WT)

12 System Timer (SYSTIMER)

12.1 Overview

ESP32-C6 provides a 52-bit timer, which can be used to generate tick interrupts for operating system, or be used as a general timer to generate periodic interrupts or one-time interrupts. With the help of the RTC timer, system timer can be kept up to date after Light-sleep or Deep-sleep.

The timer consists of two counters: UNIT0 and UNIT1. The counter values can be monitored by three comparators COMP0, COMP1, and COMP2. See the timer block diagram on Figure 12-1.

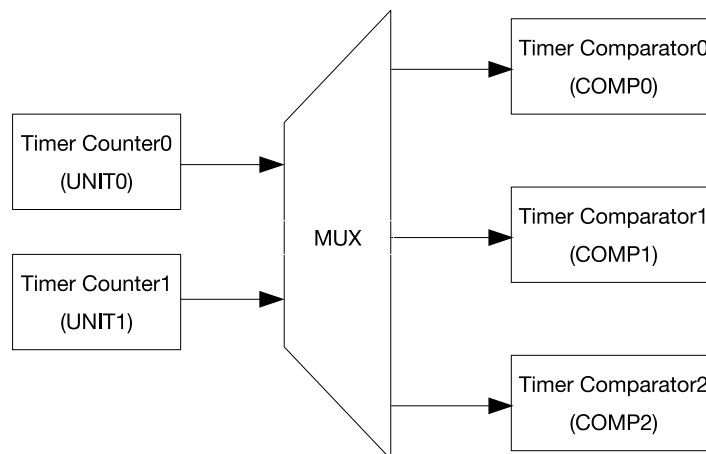

Figure 12-1. System Timer Structure

12.2 Features

The system timer has the following features:

- Two 52-bit counters and three 52-bit comparators
- Software accessing registers clocked by APB_CLK
- CNT_CLK used for counting, with an average frequency of 16 MHz in two counting cycles
- 40 MHz XTAL_CLK as the clock source of CNT_CLK
- 52-bit alarm values (t) and 26-bit alarm periods (δt)
- Two modes to generate alarms:
 - Target mode: only a one-time alarm is generated based on the alarm value (t)
 - Period mode: periodic alarms are generated based on the alarm period (δt)
- Three comparators generating three independent interrupts based on configured alarm value (t) or alarm period (δt)
- Able to load back sleep time recorded by RTC timer via software after Deep-sleep or Light-sleep
- Able to stall or continue running when CPU stalls or enters the on-chip-debugging mode

- Alarm for Event Task Matrix (ETM) event

12.3 Clock Source Selection

The counters and comparators use XTAL_CLK or RC_FAST_CLK as the clock sources. The clock source can be selected by configuring field `PCR_SYSTIMER_FUNC_CLK_SEL` in register `PCR_SYSTIMER_FUNC_CLK_CONF_REG`. After XTAL_CLK is scaled by a fractional divider, a $f_{XTAL_CLK}/3$ clock is generated in one count cycle and a $f_{XTAL_CLK}/2$ clock in another count cycle. The average clock frequency is $f_{XTAL_CLK}/2.5$, which is 16 MHz, i.e. the CNT_CLK in Figure 12-2. The timer counter is incremented by $1/16 \mu s$ on each CNT_CLK cycle.

Software operation such as configuring registers is clocked by APB_CLK. For more information about APB_CLK, see Chapter 8 *Reset and Clock*.

The following two bits of system registers are also used to control the system timer:

- Set `PCR_SYSTIMER_CLK_EN` in register `PCR_SYSTIMER_CONF_REG` to enable APB_CLK signal to the system timer.
- Set `PCR_SYSTIMER_RST_EN` in register `PCR_SYSTIMER_CONF_REG` to reset the system timer.

Note that if the timer is reset, its registers will be restored to their default values. For more information, please refer to Chapter 8 *Reset and Clock*.

12.4 Functional Description

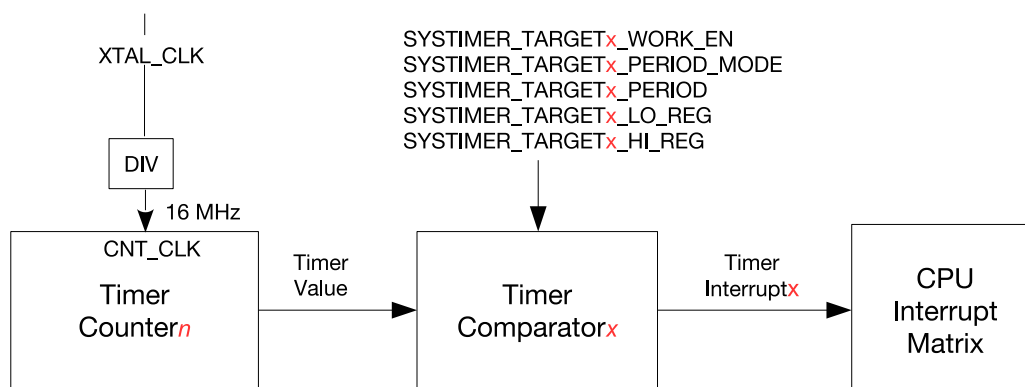

Figure 12-2. System Timer Alarm Generation

Figure 12-2 shows the procedure to generate alarm in system timer. In this process, one timer counter and one timer comparator are used. An alarm interrupt will be generated accordingly based on the comparison result in comparator.

12.4.1 Counter

The system timer has two 52-bit timer counters, shown as UNIT n ($n = 0$ or 1). Their counting clock source is a 16 MHz clock, i.e. CNT_CLK. Whether UNIT n works or not is controlled by two bits in register `SYSTIMER_CONF_REG`:

- `SYSTIMER_TIMER_UNITn_WORK_EN`: set this bit to enable the counter UNIT n in system timer.

- `SYSTIMER_TIMER_UNIT n _CORE0_STALL_EN`: if this bit is set, the counter UNIT n stops when CPU is stalled. The counter continues its counting after the CPU resumes.

The configuration of the two bits to control the counter UNIT n is shown below, assuming that CPU is stalled.

Table 12-1. UNIT n Configuration Bits

<code>SYSTIMER_TIMER_UNITn_WORK_EN</code>	<code>SYSTIMER_TIMER_UNITn_CORE0_STALL_EN</code>	Counter UNIT n
0	x*	Not at work
1	1	Stop counting, but will continue its counting after the CPU resumes
1	0	Keep counting

* x: Don't-care.

When the counter UNIT n is at work, the count value is incremented on each counting cycle. When the counter UNIT n is stopped, the count value stops increasing and keeps unchanged.

The lower 32 and higher 20 bits of initial count value are loaded from the registers `SYSTIMER_TIMER_UNIT n _LOAD_LO` and `SYSTIMER_TIMER_UNIT n _LOAD_HI`. Writing 1 to the bit `SYSTIMER_TIMER_UNIT n _LOAD` will trigger a reload event, and the current count value will be changed immediately. If UNIT n is at work, the counter will continue to count up from the new reloaded value.

Writing 1 to `SYSTIMER_TIMER_UNIT n _UPDATE` will trigger an update event. The lower 32 and higher 20 bits of current count value will be locked into the registers `SYSTIMER_TIMER_UNIT n _VALUE_LO` and `SYSTIMER_TIMER_UNIT n _VALUE_HI`, and then `SYSTIMER_TIMER_UNIT n _VALUE_VALID` is asserted. Before the next update event, the values of `SYSTIMER_TIMER_UNIT n _VALUE_LO` and `SYSTIMER_TIMER_UNIT n _VALUE_HI` remain unchanged.

12.4.2 Comparator and Alarm

The system timer has three 52-bit comparators, shown as COMP x ($x = 0, 1, \text{ or } 2$). The comparators can generate independent interrupts based on different alarm values (t) or alarm periods (δt).

Configure `SYSTIMER_TARGET x _PERIOD_MODE` to choose from the two alarm modes for each COMP x :

- 1: period mode
- 0: target mode

In period mode, the alarm period (δt) is provided by the register `SYSTIMER_TARGET x _PERIOD`. Assuming that current count value is t_1 , when it reaches $(t_1 + \delta t)$, an alarm interrupt will be generated. When the counter value reaches $(t_1 + 2 * \delta t)$, another alarm interrupt also will be generated. By such way, periodic alarms are generated.

In target mode, the lower 32 bits and higher 20 bits of the alarm value (t) are provided by `SYSTIMER_TIMER_TARGET x _LO` and `SYSTIMER_TIMER_TARGET x _HI`. Assuming that current count value is t_2 ($t_2 \leq t$), an alarm interrupt will be generated when the count value reaches the alarm value (t). Unlike in period mode, only one alarm interrupt is generated in target mode.

`SYSTIMER_TARGETx_TIMER_UNIT_SEL` is used to choose the count value from which timer counter to be compared for alarm:

- 1: Use the count value from UNIT1
- 0: Use the count value from UNIT0

Finally, set `SYSTIMER_TARGETx_WORK_EN` and `COMPx` starts to compare the count value:

- In target mode, `COMPx` compares with the alarm value (t).
- In period mode, `COMPx` compares with the alarm period ($t_1 + n * \delta t$).

An alarm is generated when the count value equals to the alarm value (t) in target mode or to the start value + $n * \text{alarm period } \delta t$ ($n = 1, 2, 3 \dots$) in period mode. But if the alarm value (t) set in registers is less than current count value, i.e. the target has already passed, when the current count value is larger than the alarm value (t) within a range ($0 \sim 2^{51} - 1$), an alarm interrupt is also generated immediately. No matter in target mode or period mode, the low 32 bits and high 20 bits of the real alarm value can always be read from `SYSTIMER_TARGETx_LO_RO` and `SYSTIMER_TARGETx_HI_RO`. The alarm trigger point and the relationship between current count value t_c and the alarm value t_t are shown below.

Table 12-2. Trigger Point

Relationship Between t_c and t_t	Trigger Point
$t_c - t_t \leq 0$	$t_c = t_t$, an alarm is triggered.
$0 \leq t_c - t_t < 2^{51} - 1$ ($t_c < 2^{51}$ and $t_t < 2^{51}$, or $t_c \geq 2^{51}$ and $t_t \geq 2^{51}$)	An alarm is triggered immediately.
$t_c - t_t \geq 2^{51} - 1$	t_c overflows after counting to its maximum value 52'hffffffff, and then starts counting up from 0. When its value reaches t_t , an alarm is triggered.

12.4.3 Event Task Matrix

The system timer on ESP32-C6 supports the Event Task Matrix (ETM) function, which allows the system timer's ETM tasks to be triggered by any peripherals' ETM events, or system timer's ETM events to trigger any peripherals' ETM tasks. This section introduces the ETM tasks and events related to the system timer. For more information, please refer to Chapter 11 [Event Task Matrix \(SOC_ETM\)](#).

The system timer can generate the following ETM event:

- `SYSTIMER_EVT_CNT_CMPx`: Indicates the alarm pulses generated by `COMPx`.

When `SYSTIMER_ETM_EN` is set to 1, the alarm pulses can trigger the ETM event.

12.4.4 Synchronization Operation

The clock (`APB_CLK`) used in software operation is separate from `CNT_CLK` to drive the timer counters and comparators. Synchronization is needed for some configuration registers. A complete synchronization action takes two steps:

1. Software writes specific values to configuration fields, see the first column in Table 12-3.
2. Software writes 1 to corresponding bits to start synchronization, see the second column in Table 12-3.

Table 12-3. Synchronization Operation for Configuration Registers

Configuration Fields	Synchronization Enable Bit
SYSTIMER_TIMER_UNIT n _LOAD_LO SYSTIMER_TIMER_UNIT n _LOAD_HI	SYSTIMER_TIMER_UNIT n _LOAD
SYSTIMER_TARGET x _PERIOD SYSTIMER_TIMER_TARGET x _HI SYSTIMER_TIMER_TARGET x _LO	SYSTIMER_TIMER_COMP x _LOAD

Synchronization is also needed for reading some status registers since the timer counter related status have a different clock than APB_CLK. A complete synchronization action takes three steps:

1. Software writes specific values to the updating register SYSTIMER_TIMER_UNIT n _UPDATE.
2. Software reads the corresponding bit SYSTIMER_TIMER_UNIT n _VALUE_VALID to be valid to check synchronization is done.
3. Software reads corresponding status registers SYSTIMER_TIMER_UNIT n _VALUE_HI and SYSTIMER_TIMER_UNIT n _VALUE_LO.

12.4.5 Interrupt

Each comparator has one level-type alarm interrupt, named as SYSTIMER_TARGET x _INT. Interrupts signal is asserted high when the comparator starts to alarm. Until the interrupt is cleared by software, it remains high. To enable interrupts, set the bit SYSTIMER_TARGET x _INT_ENA.

12.5 Programming Procedure

12.5.1 Read Current Count Value

1. Set SYSTIMER_TIMER_UNIT n _UPDATE to update the current count value of COMP x into SYSTIMER_TIMER_UNIT n _VALUE_HI and SYSTIMER_TIMER_UNIT n _VALUE_LO.
2. Poll the reading of SYSTIMER_TIMER_UNIT n _VALUE_VALID till it's 1. Then, user can read the count value from SYSTIMER_TIMER_UNIT n _VALUE_HI and SYSTIMER_TIMER_UNIT n _VALUE_LO.
3. Read the lower 32 bits and higher 20 bits from SYSTIMER_TIMER_UNIT n _VALUE_LO and SYSTIMER_TIMER_UNIT n _VALUE_HI respectively.

12.5.2 Configure One-Time Alarm in Target Mode

1. Set SYSTIMER_TARGET x _TIMER_UNIT_SEL to select the counter (UNIT0 or UNIT1) used for COMP x .
2. Read current count value, see Section 12.5.1. This value will be used to calculate the alarm value (t) in Step 4.
3. Clear SYSTIMER_TARGET x _PERIOD_MODE to enable target mode.
4. Set an alarm value (t), and fill its lower 32 bits to SYSTIMER_TIMER_TARGET x _LO, and the higher 20 bits to SYSTIMER_TIMER_TARGET x _HI.

5. Set `SYSTIMER_TIMER_COMPx_LOAD` to synchronize the alarm value (t) to `COMPx`, i.e., load the alarm value (t) to the `COMPx`.
6. Set `SYSTIMER_TARGETx_WORK_EN` to enable the selected `COMPx`. `COMPx` starts comparing the count value with the alarm value (t).
7. Set `SYSTIMER_TARGETx_INT_ENA` to enable timer interrupt. When `Unitn` counts to the alarm value (t), a `SYSTIMER_TARGETx_INT` interrupt is triggered.

12.5.3 Configure Periodic Alarms in Period Mode

1. Set `SYSTIMER_TARGETx_TIMER_UNIT_SEL` to select the counter (`UNIT0` or `UNIT1`) used for `COMPx`.
2. Set an alarm period (δt), and fill it to `SYSTIMER_TARGETx_PERIOD`.
3. Set `SYSTIMER_TIMER_COMPx_LOAD` to synchronize the alarm period (δt) to `COMPx`, i.e., load the alarm period (δt) to `COMPx`.
4. Set `SYSTIMER_TARGETx_PERIOD_MODE` to configure `COMPx` into period mode.
5. Set `SYSTIMER_TARGETx_WORK_EN` to enable the selected `COMPx`. `COMPx` starts comparing the count value with the sum of (start value + $n * \delta t$) ($n = 1, 2, 3 \dots$).
6. Set `SYSTIMER_TARGETx_INT_ENA` to enable timer interrupt. A `SYSTIMER_TARGETx_INT` interrupt is triggered when `Unitn` counts to start value + $n * \delta t$ ($n = 1, 2, 3 \dots$) set in Step 2.

12.5.4 Update After Deep-sleep and Light-sleep

1. Configure RTC timer before the chip goes to Deep-sleep or Light-sleep, to record the exact sleep time. For more information, see Chapter 2 *Low-Power Management [to be added later]*.
2. Read the sleep time from RTC timer when the chip is woken up from Deep-sleep or Light-sleep.
3. Read current count value of system timer, see Section 12.5.1.
4. Convert the time value recorded by RTC timer from the clock cycles based on `RTC_SLOW_CLK` to that based on 16 MHz `CNT_CLK`. For example, if the frequency of `RTC_SLOW_CLK` is 32 kHz, the recorded RTC timer value should be converted by multiplying by 500.
5. Add the converted RTC value to current count value of system timer:
 - Fill the new value into `SYSTIMER_TIMER_UNITn_LOAD_LO` (low 32 bits) and `SYSTIMER_TIMER_UNITn_LOAD_HI` (high 20 bits).
 - Set `SYSTIMER_TIMER_UNITn_LOAD` to load new timer value into system timer. By such way, the system timer is updated.

12.6 Register Summary

The addresses in this section are relative to system timer base address provided in Table 5-2 in Chapter 5 *System and Memory*.

The abbreviations given in Column **Access** are explained in Section *Access Types for Registers*.

Name	Description	Address	Access
Clock Control Register			
SYSTIMER_CONF_REG	Configure system timer clock	0x0000	R/W
UNIT0 Control and Configuration Registers			
SYSTIMER_UNIT0_OP_REG	Read UNIT0 value to registers	0x0004	varies
SYSTIMER_UNIT0_LOAD_HI_REG	High 20 bits to be loaded to UNIT0	0x000C	R/W
SYSTIMER_UNIT0_LOAD_LO_REG	Low 32 bits to be loaded to UNIT0	0x0010	R/W
SYSTIMER_UNIT0_VALUE_HI_REG	UNIT0 value, high 20 bits	0x0040	RO
SYSTIMER_UNIT0_VALUE_LO_REG	UNIT0 value, low 32 bits	0x0044	RO
SYSTIMER_UNIT0_LOAD_REG	UNIT0 synchronization register	0x005C	WT
UNIT1 Control and Configuration Registers			
SYSTIMER_UNIT1_OP_REG	Read UNIT1 value to registers	0x0008	varies
SYSTIMER_UNIT1_LOAD_HI_REG	High 20 bits to be loaded to UNIT1	0x0014	R/W
SYSTIMER_UNIT1_LOAD_LO_REG	Low 32 bits to be loaded to UNIT1	0x0018	R/W
SYSTIMER_UNIT1_VALUE_HI_REG	UNIT1 value, high 20 bits	0x0048	RO
SYSTIMER_UNIT1_VALUE_LO_REG	UNIT1 value, low 32 bits	0x004C	RO
SYSTIMER_UNIT1_LOAD_REG	UNIT1 synchronization register	0x0060	WT
Comparator0 Control and Configuration Registers			
SYSTIMER_TARGET0_HI_REG	Alarm value to be loaded to COMP0, high 20 bits	0x001C	R/W
SYSTIMER_TARGET0_LO_REG	Alarm value to be loaded to COMP0, low 32 bits	0x0020	R/W
SYSTIMER_TARGET0_CONF_REG	Configure COMP0 alarm mode	0x0034	R/W
SYSTIMER_COMP0_LOAD_REG	COMP0 synchronization register	0x0050	WT
Comparator1 Control and Configuration Registers			
SYSTIMER_TARGET1_HI_REG	Alarm value to be loaded to COMP1, high 20 bits	0x0024	R/W
SYSTIMER_TARGET1_LO_REG	Alarm value to be loaded to COMP1, low 32 bits	0x0028	R/W
SYSTIMER_TARGET1_CONF_REG	Configure COMP1 alarm mode	0x0038	R/W
SYSTIMER_COMP1_LOAD_REG	COMP1 synchronization register	0x0054	WT
Comparator2 Control and Configuration Registers			
SYSTIMER_TARGET2_HI_REG	Alarm value to be loaded to COMP2, high 20 bits	0x002C	R/W
SYSTIMER_TARGET2_LO_REG	Alarm value to be loaded to COMP2, low 32 bits	0x0030	R/W
SYSTIMER_TARGET2_CONF_REG	Configure COMP2 alarm mode	0x003C	R/W
SYSTIMER_COMP2_LOAD_REG	COMP2 synchronization register	0x0058	WT
Interrupt Registers			
SYSTIMER_INT_ENA_REG	Interrupt enable register of system timer	0x0064	R/W
SYSTIMER_INT_RAW_REG	Interrupt raw register of system timer	0x0068	R/WTC/SS
SYSTIMER_INT_CLR_REG	Interrupt clear register of system timer	0x006C	WT
SYSTIMER_INT_ST_REG	Interrupt status register of system timer	0x0070	RO
COMP0 Status Registers			
SYSTIMER_REAL_TARGET0_LO_REG	Actual target value of COMP0, low 32 bits	0x0074	RO

Name	Description	Address	Access
SYSTIMER_REAL_TARGET0_HI_REG	Actual target value of COMP0, high 20 bits	0x0078	RO
COMP1 Status Registers			
SYSTIMER_REAL_TARGET1_LO_REG	Actual target value of COMP1, low 32 bits	0x007C	RO
SYSTIMER_REAL_TARGET1_HI_REG	Actual target value of COMP1, high 20 bits	0x0080	RO
COMP2 Status Registers			
SYSTIMER_REAL_TARGET2_LO_REG	Actual target value of COMP2, low 32 bits	0x0084	RO
SYSTIMER_REAL_TARGET2_HI_REG	Actual target value of COMP2, high 20 bits	0x0088	RO
Version Register			
SYSTIMER_DATE_REG	Version control register	0x00FC	R/W

12.7 Registers

The addresses in this section are relative to system timer base address provided in Table 5-2 in Chapter 5 *System and Memory*.

Register 12.1. SYSTIMER_CONF_REG (0x0000)

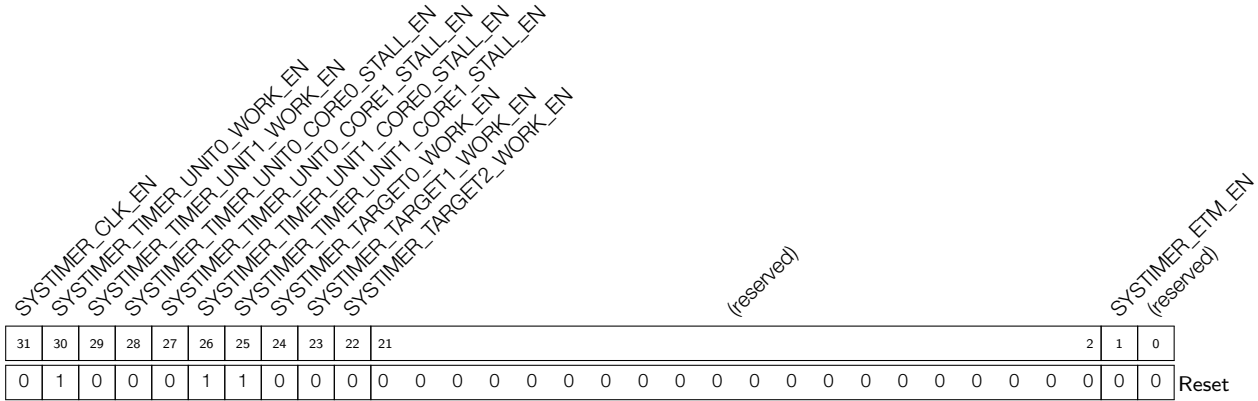

SYSTIMER_ETM_EN Configures whether or not to enable generation of ETM events.

- 0: Disable
 - 1: Enable
- (R/W)

SYSTIMER_TARGET2_WORK_EN Configures whether or not to enable COMP2.

- 0: Disable
 - 1: Enable
- (R/W)

SYSTIMER_TARGET1_WORK_EN Configures whether or not to enable COMP1. See details in [SYSTIMER_TARGET2_WORK_EN](#). (R/W)

SYSTIMER_TARGET0_WORK_EN Configures whether or not to enable COMP0. See details in [SYSTIMER_TARGET2_WORK_EN](#). (R/W)

SYSTIMER_TIMER_UNIT1_CORE1_STALL_EN Configures whether or not UNIT1 is stalled when CORE1 is stalled.

- 0: UNIT1 is not stalled.
- 1: UNIT1 is stalled.

(R/W)

SYSTIMER_TIMER_UNIT1_CORE0_STALL_EN Configures whether or not UNIT1 is stalled when CORE0 is stalled. See details in [SYSTIMER_TIMER_UNIT1_CORE1_STALL_EN](#). (R/W)

SYSTIMER_TIMER_UNIT0_CORE1_STALL_EN Configures whether or not UNIT0 is stalled when CORE1 is stalled. See details in [SYSTIMER_TIMER_UNIT1_CORE1_STALL_EN](#). (R/W)

SYSTIMER_TIMER_UNIT0_CORE0_STALL_EN Configures whether or not UNIT0 is stalled when CORE0 is stalled. See details in [SYSTIMER_TIMER_UNIT1_CORE1_STALL_EN](#). (R/W)

Continued on the next page...

Register 12.3. SYSTIMER_UNIT0_LOAD_HI_REG (0x000C)

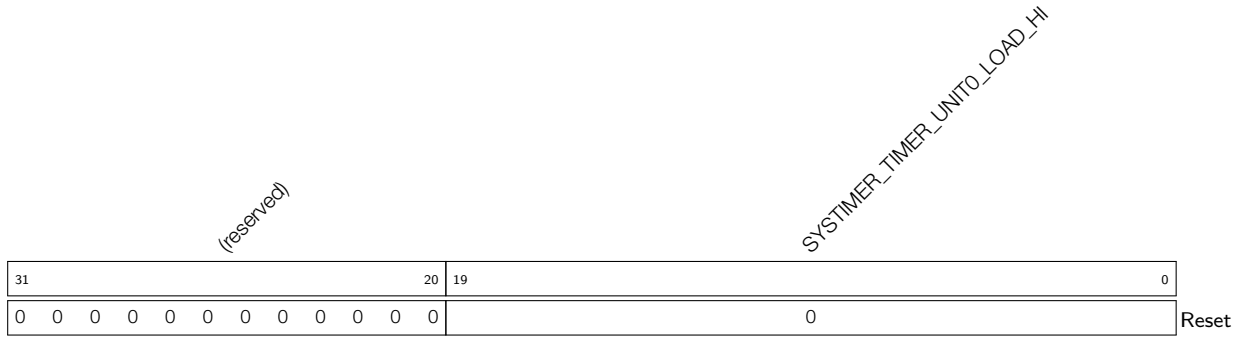

SYSTIMER_TIMER_UNIT0_LOAD_HI Configures the value to be loaded to UNIT0, high 20 bits. (R/W)

Register 12.4. SYSTIMER_UNIT0_LOAD_LO_REG (0x0010)

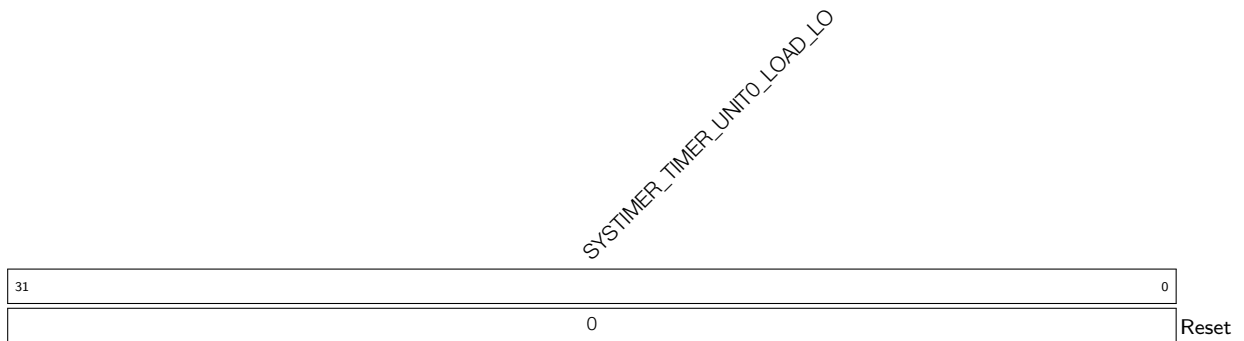

SYSTIMER_TIMER_UNIT0_LOAD_LO Configures the value to be loaded to UNIT0, low 32 bits. (R/W)

Register 12.5. SYSTIMER_UNIT0_VALUE_HI_REG (0x0040)

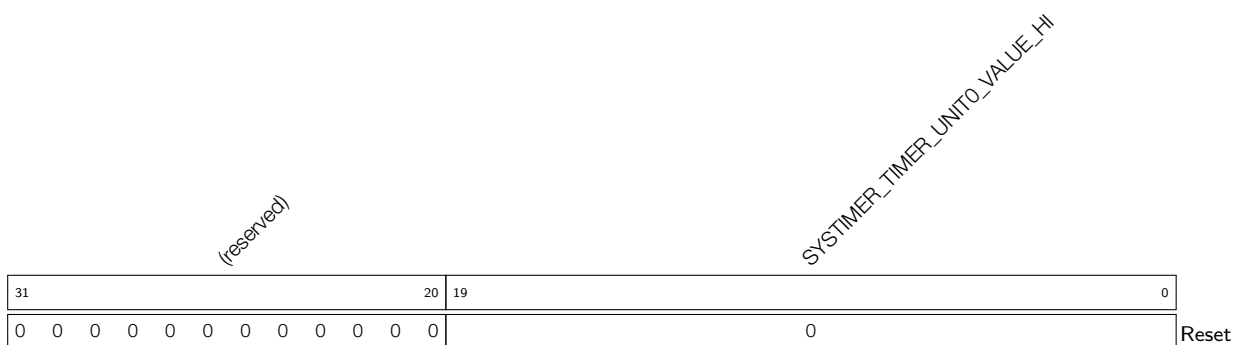

SYSTIMER_TIMER_UNIT0_VALUE_HI Represents UNIT0 read value, high 20 bits. (RO)

Register 12.10. SYSTIMER_UNIT1_LOAD_LO_REG (0x0018)

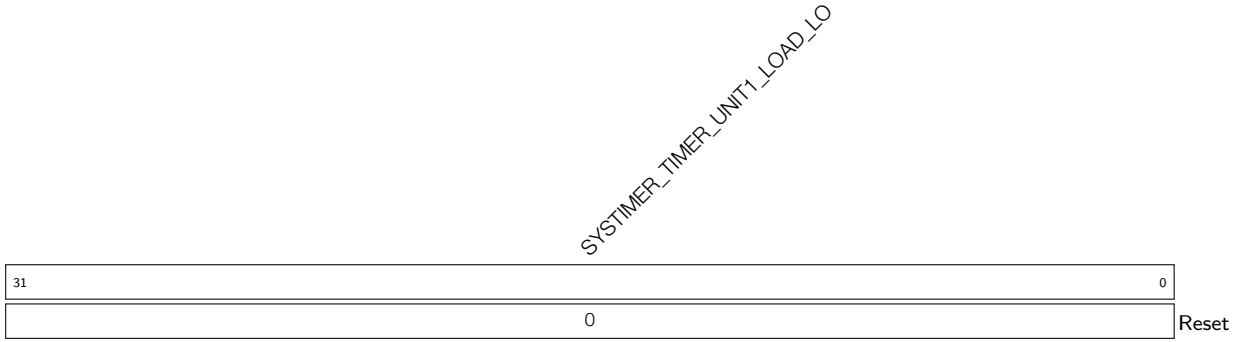

SYSTIMER_TIMER_UNIT1_LOAD_LO Configures the value to be loaded to UNIT1, low 32 bits. (R/W)

Register 12.11. SYSTIMER_UNIT1_VALUE_HI_REG (0x0048)

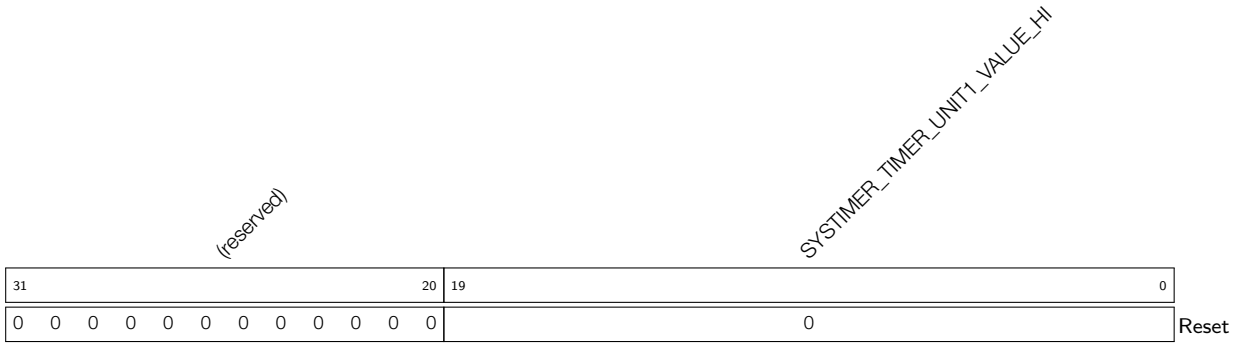

SYSTIMER_TIMER_UNIT1_VALUE_HI Represents UNIT1 read value, high 20 bits. (RO)

Register 12.12. SYSTIMER_UNIT1_VALUE_LO_REG (0x004C)

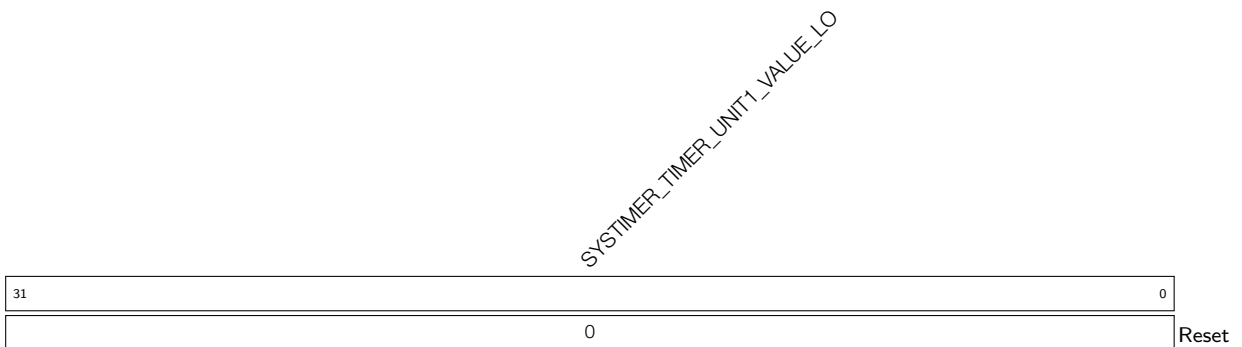

SYSTIMER_TIMER_UNIT1_VALUE_LO Represents UNIT1 read value, low 32 bits. (RO)

Register 12.13. SYSTIMER_UNIT1_LOAD_REG (0x0060)

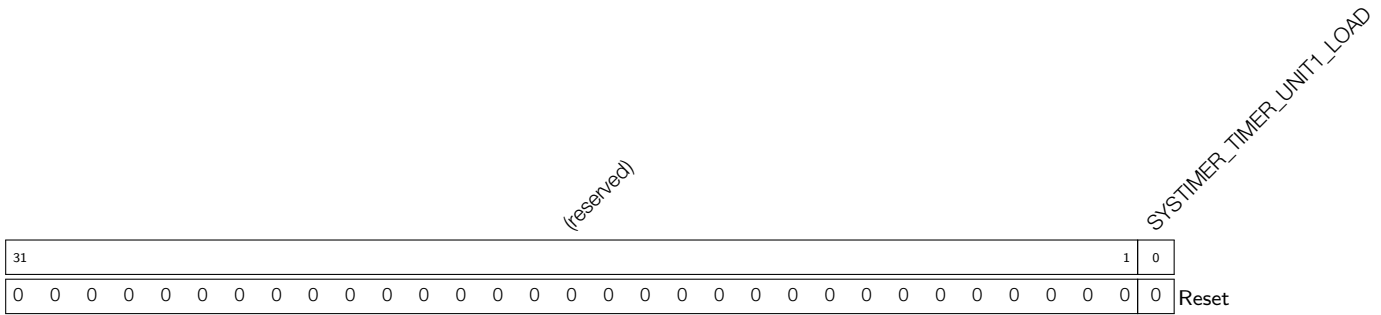

SYSTIMER_TIMER_UNIT1_LOAD Configures whether or not to reload the value of UNIT1, i.e., reload the values of [SYSTIMER_TIMER_UNIT1_VALUE_HI](#) and [SYSTIMER_TIMER_UNIT1_VALUE_LO](#) to UNIT1.
 0: No effect
 1: Reload the value of UNIT1
 (WT)

Register 12.14. SYSTIMER_TARGET0_HI_REG (0x001C)

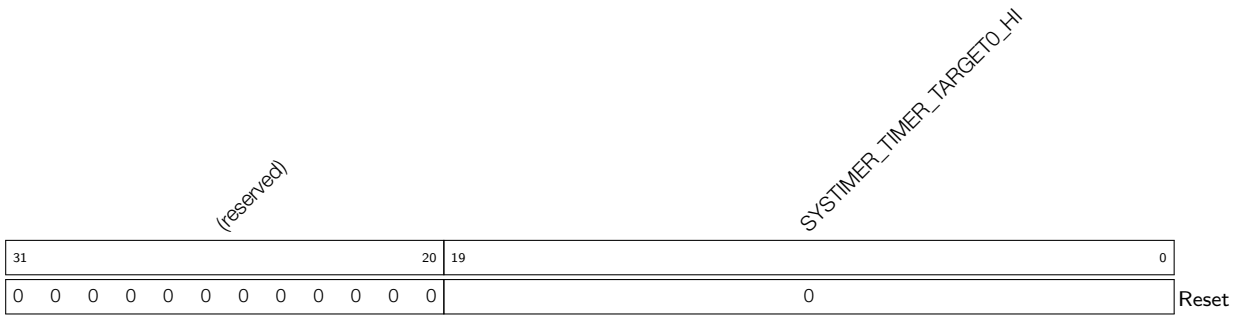

SYSTIMER_TIMER_TARGET0_HI Configures the alarm value to be loaded to COMP0, high 20 bits.
 (R/W)

Register 12.15. SYSTIMER_TARGET0_LO_REG (0x0020)

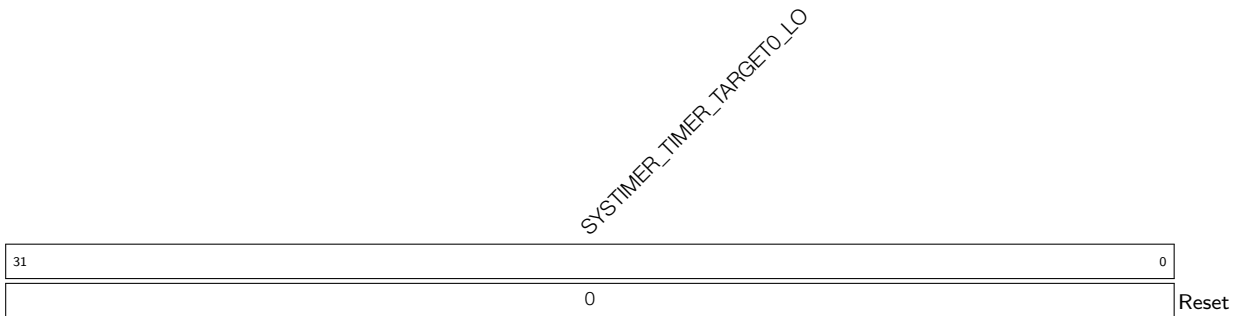

SYSTIMER_TIMER_TARGET0_LO Configures the alarm value to be loaded to COMP0, low 32 bits.
 (R/W)

Register 12.16. SYSTIMER_TARGET0_CONF_REG (0x0034)

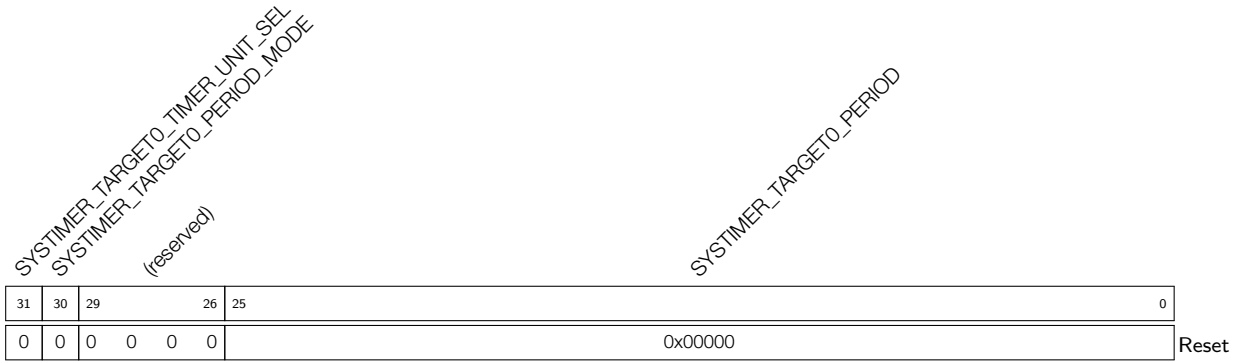

SYSTIMER_TARGET0_PERIOD Configures COMP0 alarm period. (R/W)

SYSTIMER_TARGET0_PERIOD_MODE Selects the two alarm modes for COMP0.

- 0: Target mode
 - 1: Period mode
- (R/W)

SYSTIMER_TARGET0_TIMER_UNIT_SEL Chooses the counter value for comparison with COMP0.

- 0: Use the count value from UNIT0
 - 1: Use the count value from UNIT1
- (R/W)

Register 12.17. SYSTIMER_COMP0_LOAD_REG (0x0050)

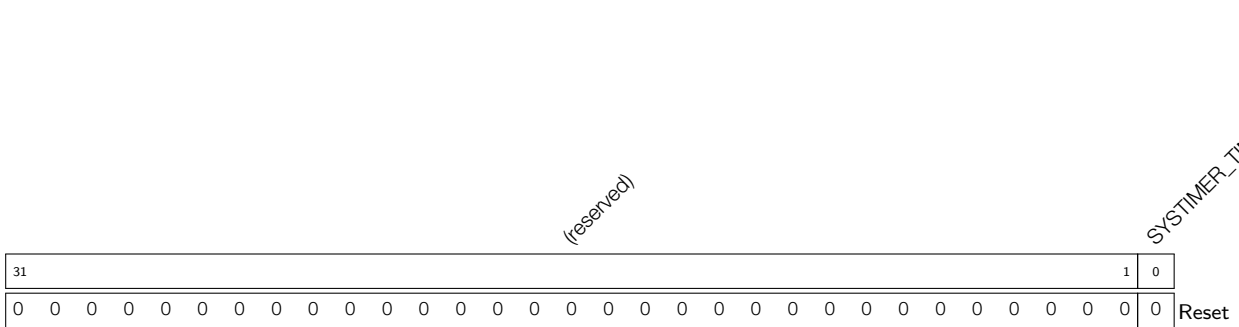

SYSTIMER_TIMER_COMP0_LOAD Configures whether or not to enable COMP0 synchronization, i.e., reload the alarm value/period to COMP0.

- 0: No effect
 - 1: Enable COMP0 synchronization
- (WT)

Register 12.18. SYSTIMER_TARGET1_HI_REG (0x0024)

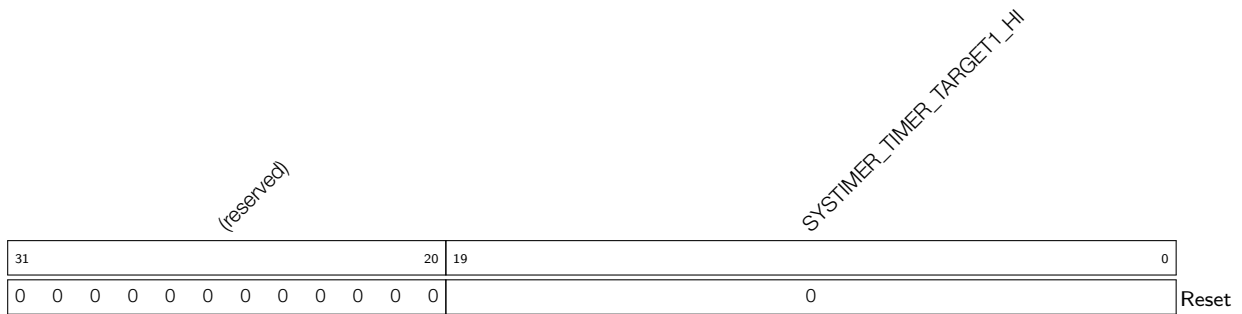

SYSTIMER_TIMER_TARGET1_HI Configures the alarm value to be loaded to COMP1, high 20 bits.
(R/W)

Register 12.19. SYSTIMER_TARGET1_LO_REG (0x0028)

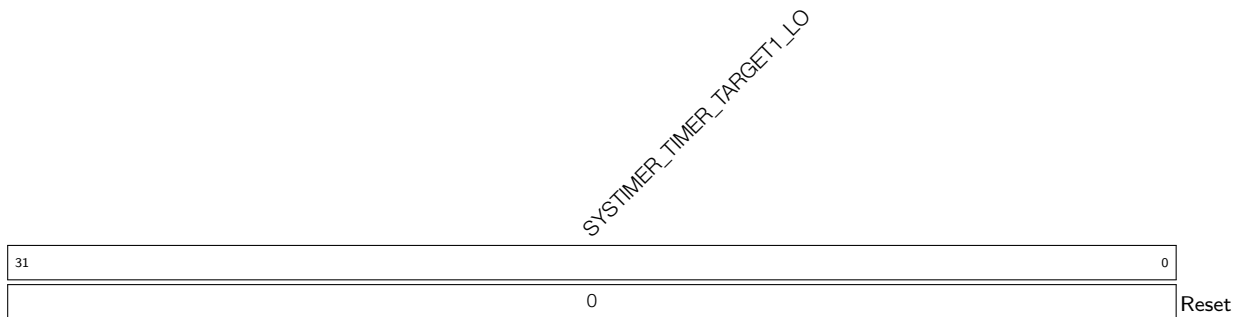

SYSTIMER_TIMER_TARGET1_LO Configures the alarm value to be loaded to COMP1, low 32 bits.
(R/W)

Register 12.20. SYSTIMER_TARGET1_CONF_REG (0x0038)

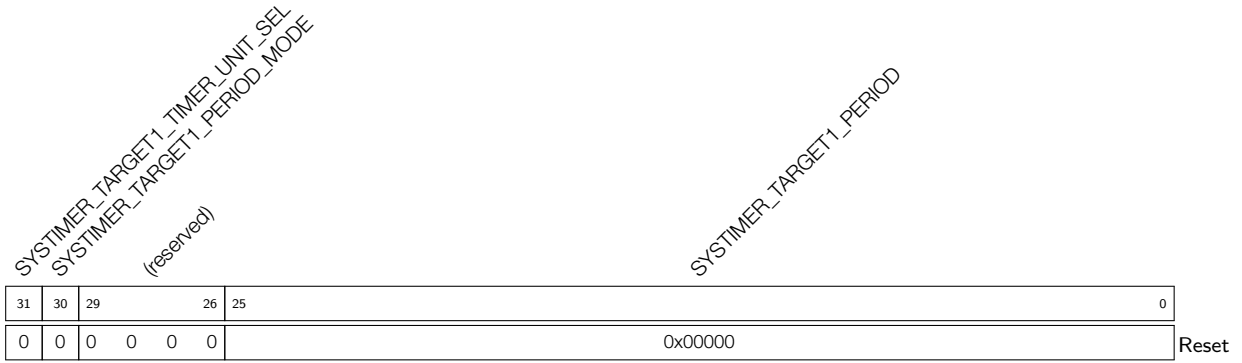

SYSTIMER_TARGET1_PERIOD Configures COMP1 alarm period. (R/W)

SYSTIMER_TARGET1_PERIOD_MODE Selects the two alarm modes for COMP1. See details in [SYSTIMER_TARGET0_PERIOD_MODE](#). (R/W)

SYSTIMER_TARGET1_TIMER_UNIT_SEL Chooses the counter value for comparison with COMP1. See details in [SYSTIMER_TARGET0_TIMER_UNIT_SEL](#). (R/W)

Register 12.21. SYSTIMER_COMP1_LOAD_REG (0x0054)

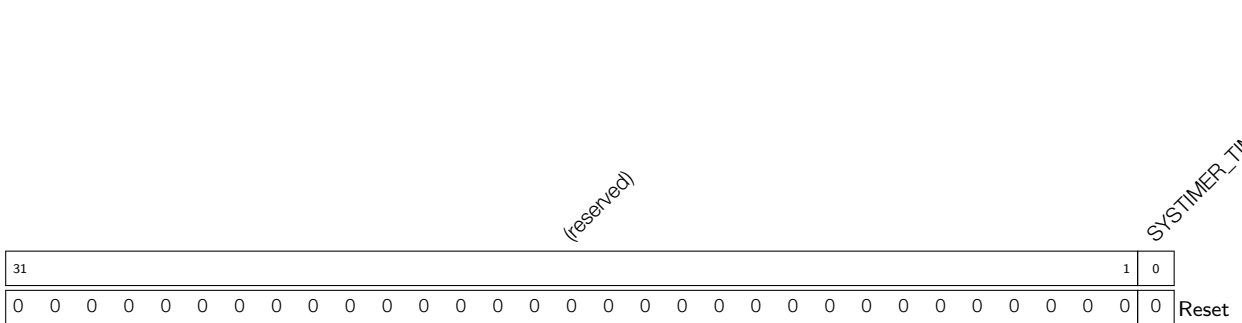

SYSTIMER_TIMER_COMP1_LOAD Configures whether or not to enable COMP1 synchronization, i.e., reload the alarm value/period to COMP1.

- 0: No effect
- 1: Enable COMP1 synchronization (WT)

Register 12.22. SYSTIMER_TARGET2_HI_REG (0x002C)

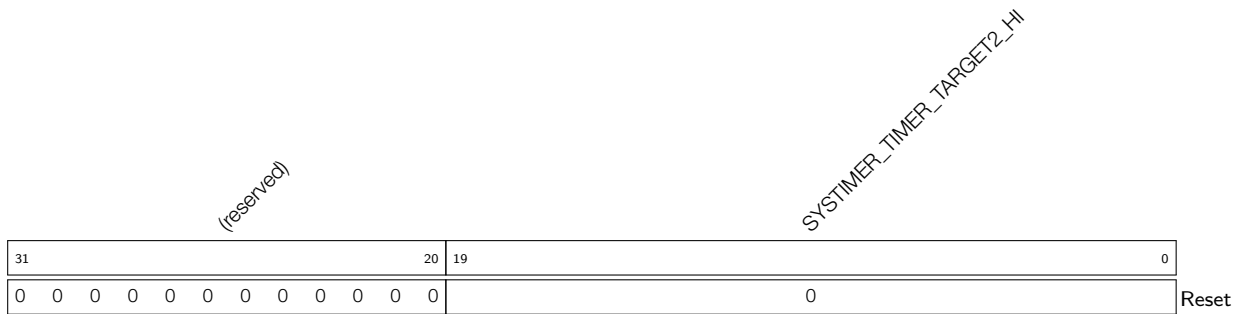

SYSTIMER_TIMER_TARGET2_HI Configures the alarm value to be loaded to COMP2, high 20 bits.
(R/W)

Register 12.23. SYSTIMER_TARGET2_LO_REG (0x0030)

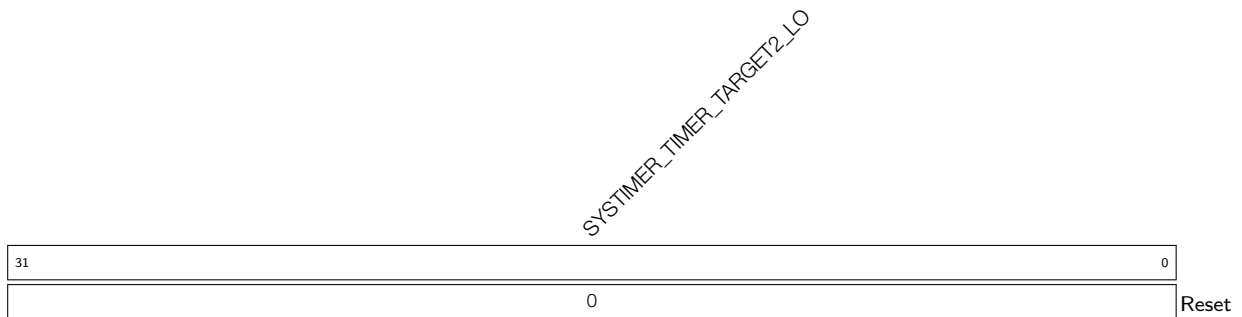

SYSTIMER_TIMER_TARGET2_LO Configures the alarm value to be loaded to COMP2, low 32 bits.
(R/W)

Register 12.24. SYSTIMER_TARGET2_CONF_REG (0x003C)

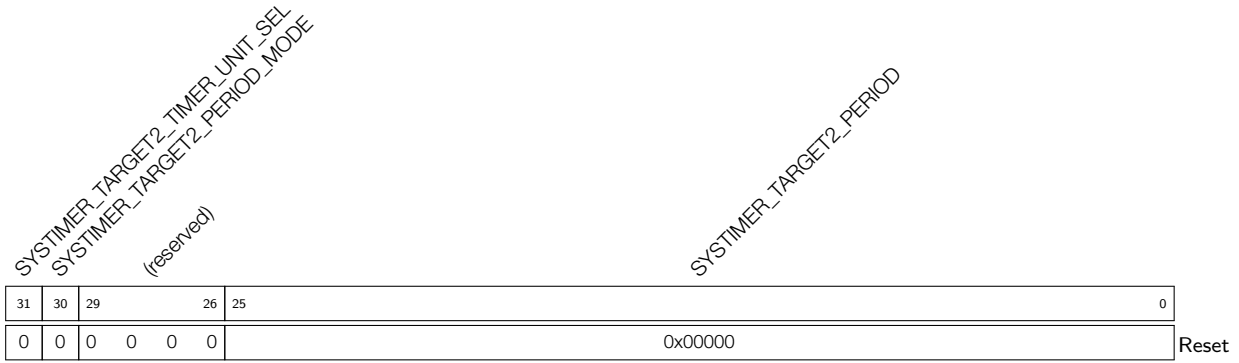

SYSTIMER_TARGET2_PERIOD Configures COMP2 alarm period. (R/W)

SYSTIMER_TARGET2_PERIOD_MODE Configures the two alarm modes for COMP2. See details in [SYSTIMER_TARGET0_PERIOD_MODE](#). (R/W)

SYSTIMER_TARGET2_TIMER_UNIT_SEL Chooses the counter value for comparison with COMP2. See details in [SYSTIMER_TARGET0_TIMER_UNIT_SEL](#). (R/W)

Register 12.25. SYSTIMER_COMP2_LOAD_REG (0x0058)

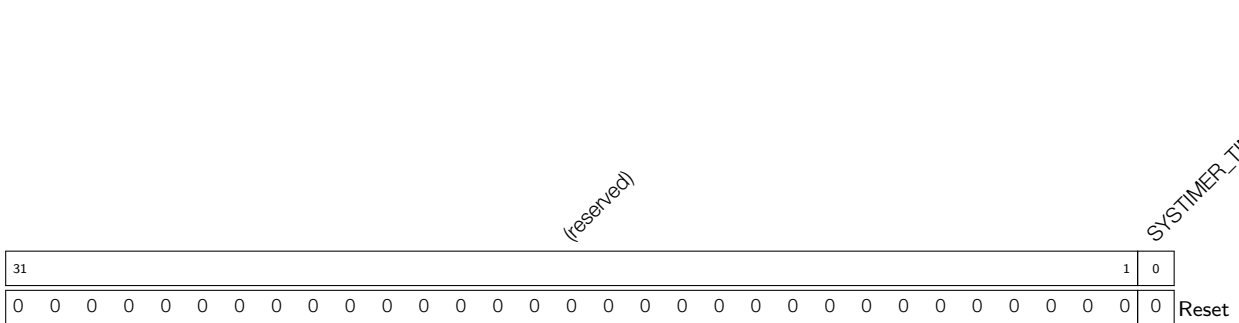

SYSTIMER_TIMER_COMP2_LOAD Configures whether or not to enable COMP2 synchronization, i.e., reload the alarm value/period to COMP2.
 0: No effect
 1: Enable COMP2 synchronization (WT)

Register 12.26. SYSTIMER_INT_ENA_REG (0x0064)

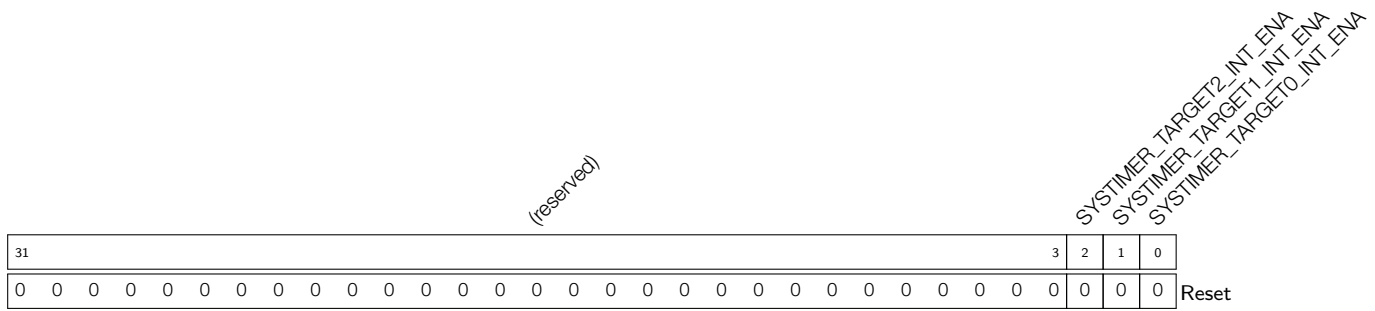

SYSTIMER_TARGET0_INT_ENA Write 1 to enable SYSTIMER_TARGET0_INT. (R/W)

SYSTIMER_TARGET1_INT_ENA Write 1 to enable SYSTIMER_TARGET1_INT. (R/W)

SYSTIMER_TARGET2_INT_ENA Write 1 to enable SYSTIMER_TARGET2_INT. (R/W)

Register 12.27. SYSTIMER_INT_RAW_REG (0x0068)

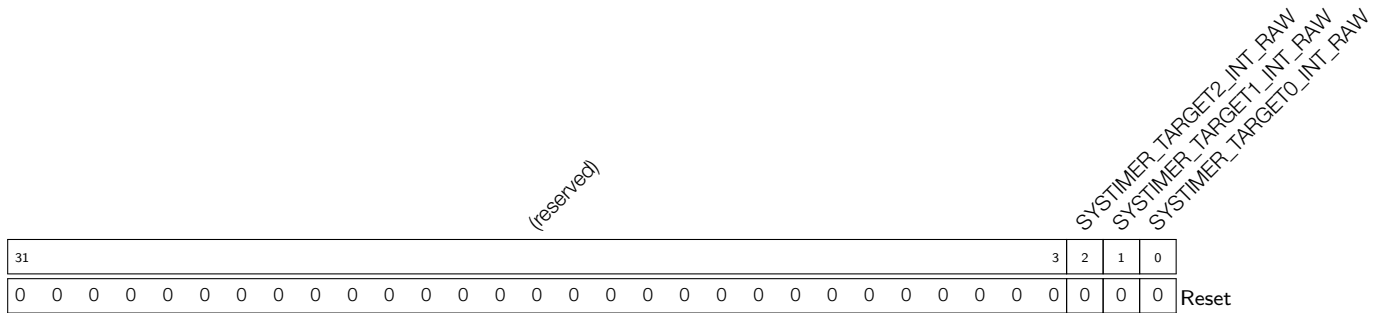

SYSTIMER_TARGET0_INT_RAW The raw interrupt status of SYSTIMER_TARGET0_INT. (R/WTC/SS)

SYSTIMER_TARGET1_INT_RAW The raw interrupt status of SYSTIMER_TARGET1_INT. (R/WTC/SS)

SYSTIMER_TARGET2_INT_RAW The raw interrupt status of SYSTIMER_TARGET2_INT. (R/WTC/SS)

Register 12.28. SYSTIMER_INT_CLR_REG (0x006C)

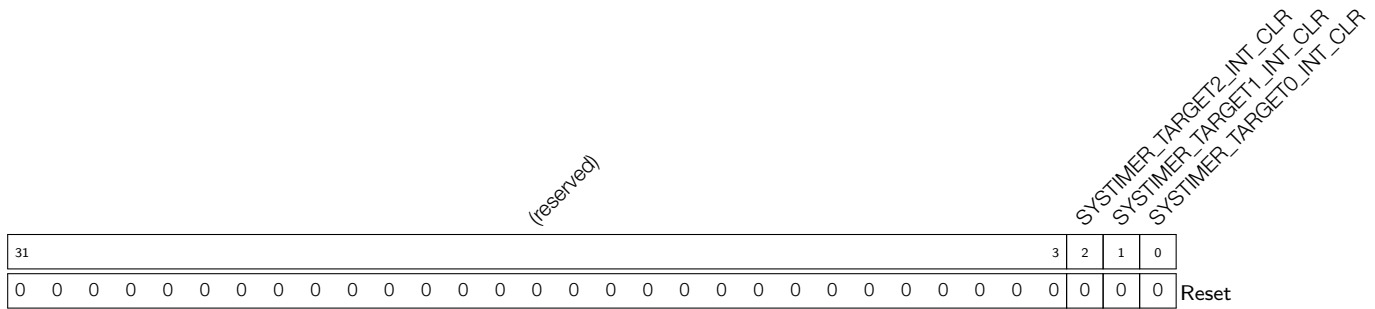

SYSTIMER_TARGET0_INT_CLR Write 1 to clear SYSTIMER_TARGET0_INT. (WT)

SYSTIMER_TARGET1_INT_CLR Write 1 to clear SYSTIMER_TARGET1_INT. (WT)

SYSTIMER_TARGET2_INT_CLR Write 1 to clear SYSTIMER_TARGET2_INT. (WT)

Register 12.29. SYSTIMER_INT_ST_REG (0x0070)

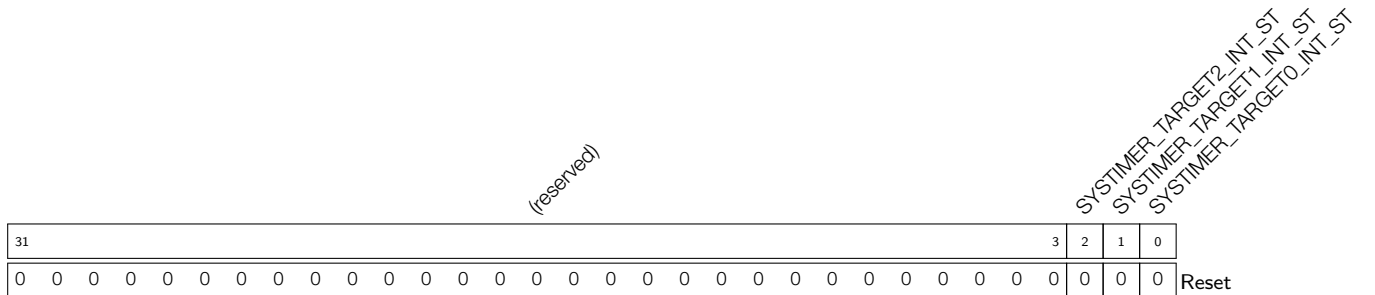

SYSTIMER_TARGET0_INT_ST The interrupt status of SYSTIMER_TARGET0_INT. (RO)

SYSTIMER_TARGET1_INT_ST The interrupt status of SYSTIMER_TARGET1_INT. (RO)

SYSTIMER_TARGET2_INT_ST The interrupt status of SYSTIMER_TARGET2_INT. (RO)

Register 12.30. SYSTIMER_REAL_TARGET0_LO_REG (0x0074)

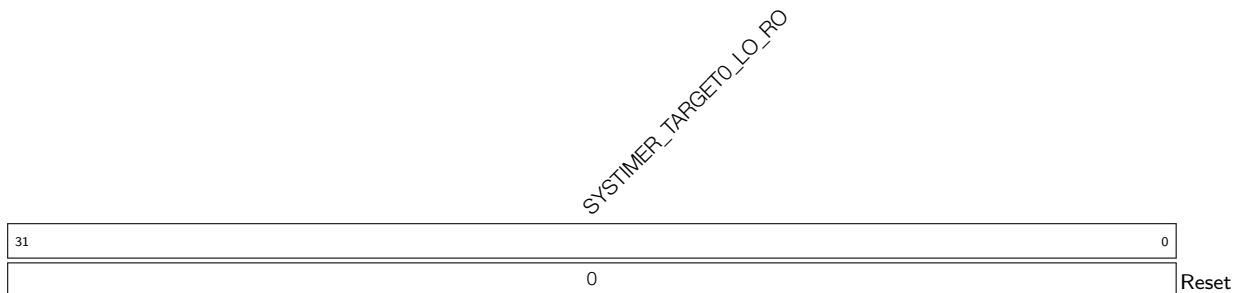

SYSTIMER_TARGET0_LO_RO Represents the actual target value of COMP0, low 32 bits. (RO)

Register 12.31. SYSTIMER_REAL_TARGET0_HI_REG (0x0078)



SYSTIMER_TARGET0_HI_RO Represents the actual target value of COMP0, high 20 bits. (RO)

Register 12.32. SYSTIMER_REAL_TARGET1_LO_REG (0x007C)

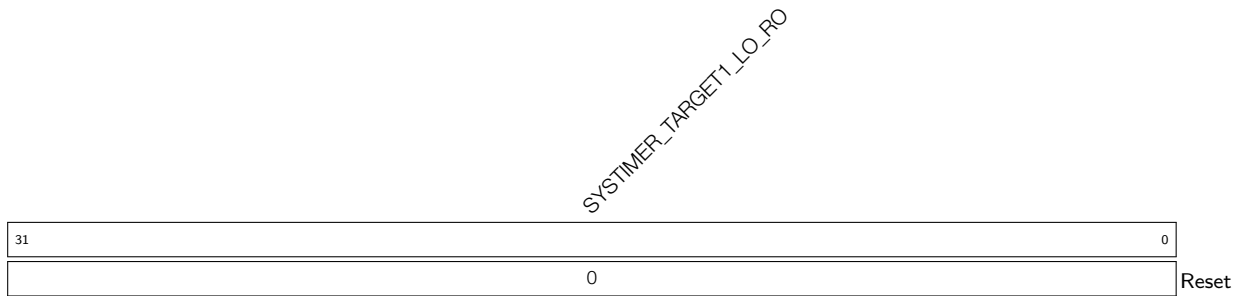

SYSTIMER_TARGET1_LO_RO Represents the actual target value of COMP1, low 32 bits. (RO)

Register 12.33. SYSTIMER_REAL_TARGET1_HI_REG (0x0080)

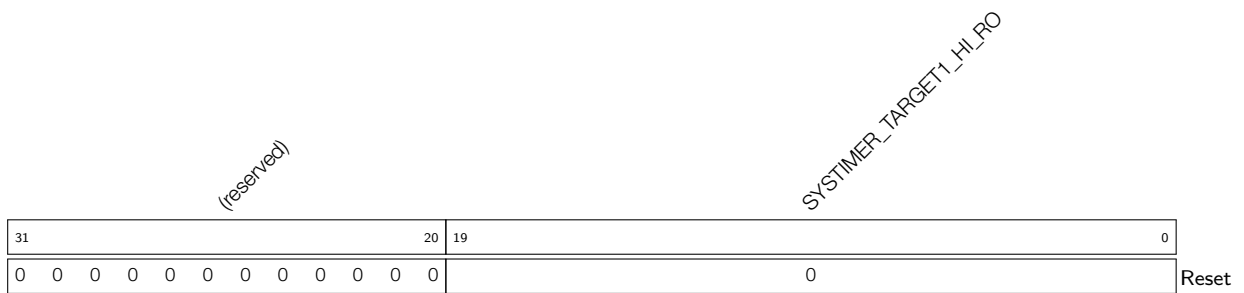

SYSTIMER_TARGET1_HI_RO Represents the actual target value of COMP1, high 20 bits. (RO)

Register 12.34. SYSTIMER_REAL_TARGET2_LO_REG (0x0084)

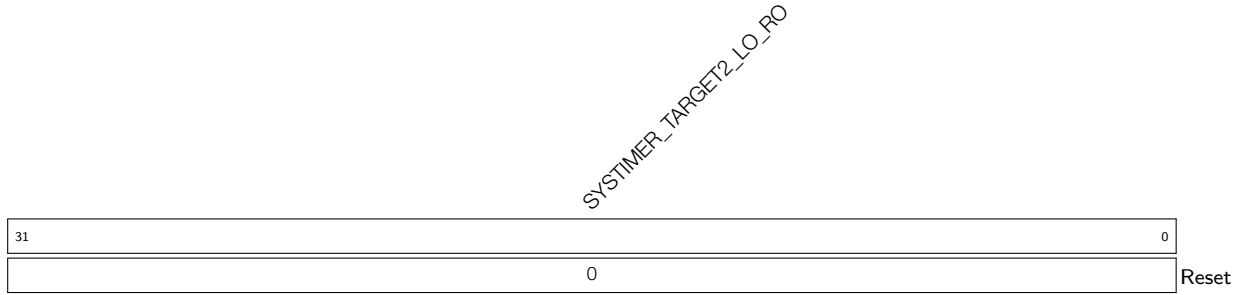

SYSTIMER_TARGET2_LO_RO Represents the actual target value of COMP2, low 32 bits. (RO)

Register 12.35. SYSTIMER_REAL_TARGET2_HI_REG (0x0088)



SYSTIMER_TARGET2_HI_RO Represents the actual target value of COMP2, high 20 bits. (RO)

Register 12.36. SYSTIMER_DATE_REG (0x00FC)

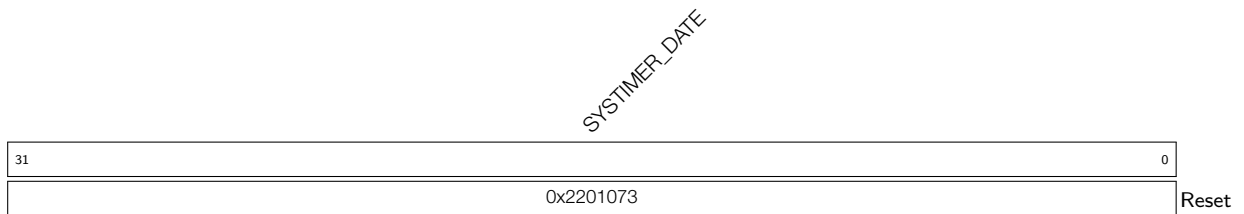

SYSTIMER_DATE Version control register. (R/W)

13 Timer Group (TIMG)

13.1 Overview

General-purpose timers can be used to precisely time an interval, trigger an interrupt after a particular interval (periodically and aperiodically), or act as a hardware clock. As shown in Figure 13-1, the ESP32-C6 chip contains two timer groups, namely timer group 0 and timer group 1. Each timer group consists of one general-purpose timer referred to as T0 and one Main System Watchdog Timer. The general-purpose timer is based on a 16-bit prescaler and a 54-bit auto-reload-capable up-down counter.

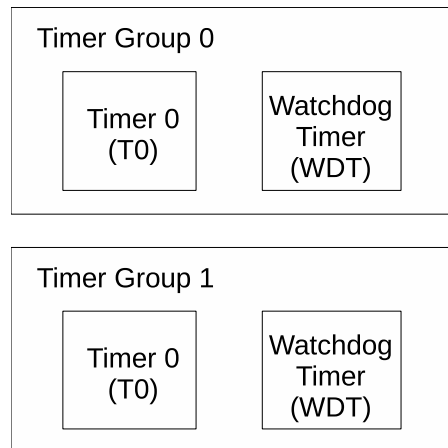

Figure 13-1. Timer Group Overview

Note that while the Main System Watchdog Timer registers are described in this chapter, their functional description is included in the Chapter 14 *Watchdog Timers (WDT)*. Therefore, the term "timer" within this chapter refers to the general-purpose timer.

13.2 Features

The timer's features are summarized as follows:

- A 54-bit time-base counter programmable to incrementing or decrementing
- Three clock sources: PLL_F80M_CLK or XTAL_CLK or RC_FAST_CLK
- A 16-bit clock prescaler, from 2 to 65536
- Able to read real-time value of the time-base counter
- Able to halt and resume the time-base counter
- Programmable alarm generation
- Timer value reload — Auto-reload at alarm or software-controlled instant reload
- RTC slow clock RTC_SLOW_CLK frequency calculation
- Level interrupt generation
- Support several ETM tasks and events

13.3 Functional Description

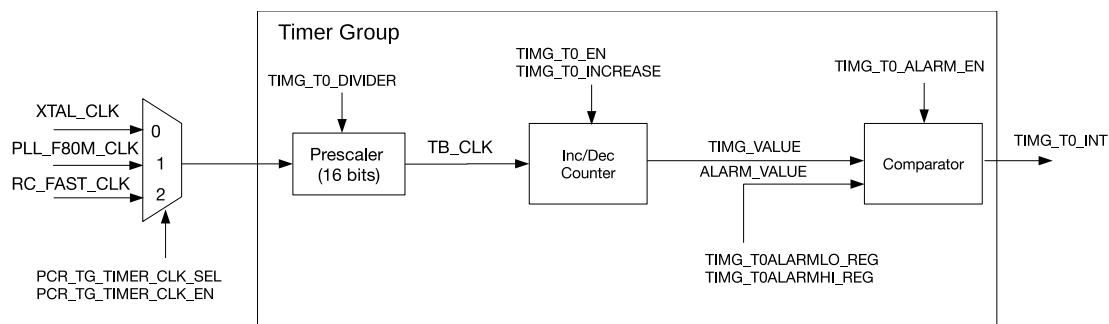

Figure 13-2. Timer Group Architecture

Figure 13-2 is a diagram of timer T0 in a timer group. T0 contains a 16-bit integer divider as a prescaler, a timer-based counter and a comparator for alarm generation.

13.3.1 16-bit Prescaler and Clock Selection

Take the T0 in timer group 0 as an example:

- The timer can select its clock source by setting the `PCR_TG0_TIMER_CLK_SEL` field of the `PCR_TIMERGROUP0_TIMER_CLK_CONF_REG` register. When the field is 0, `XTAL_CLK` is selected; when the field is 1, `PLL_F80M_CLK` is selected and when the field is 2, `RC_FAST_CLK` is selected.
- The selected clock can be switched on by setting `PCR_TG0_TIMER_CLK_EN` field of the `PCR_TIMERGROUP0_TIMER_CLK_CONF_REG` register to 1 and switched off by setting it to 0. The clock is then divided by a 16-bit prescaler to generate the time-base counter clock (`TB_CLK`) used by the time-base counter. The divisor of the prescaler can be configured through the `TIMG_TO_DIVIDER` field.

`TIMG_TO_DIVIDER` field can be configured as 0 ~ 65535 for a divisor range of 2 ~ 65536. To be more specific, when `TIMG_TO_DIVIDER` is configured as:

- 0: the divisor is 65536
- 1: the divisor is 2
- 2: the divisor is also 2
- 3 ~ 65525: the divisor is 3 ~ 65535

To modify the 16-bit prescaler, please first configure the `TIMG_TO_DIVIDER` field, and then set `TIMG_TO_DIVCNT_RST` to 1. Meanwhile, the timer must be disabled (i.e. `TIMG_TO_EN` should be cleared). Otherwise, the result can be unpredictable.

13.3.2 54-bit Time-base Counter

The 54-bit time-base counter is based on `TB_CLK` and can be configured to increment or decrement via the `TIMG_TO_INCREASE` field. The time-base counter can be enabled or disabled by setting or clearing the `TIMG_TO_EN` field, respectively. When enabled, the time-base counter increments or decrements on each cycle of `TB_CLK`. When disabled, the time-base counter is essentially frozen. Note that the `TIMG_TO_INCREASE` field can be changed no matter whether `TIMG_TO_EN` is set or not, and this will cause the time-base counter to change direction instantly.

To read the 54-bit value of the time-base counter, the timer value must be latched to two registers before being read by the CPU (due to the CPU being 32-bit). By writing any value to the `TIMG_TOUPDATE_REG`, the current value of the 54-bit timer starts to be latched into the `TIMG_TOLO_REG` and `TIMG_TOHI_REG` registers containing the lower 32-bits and higher 22-bits, respectively. When `TIMG_TOUPDATE_REG` is cleared by hardware, it indicates the latch operation has been completed and current timer value can be read from the `TIMG_TOLO_REG` and `TIMG_TOHI_REG` registers. `TIMG_TOLO_REG` and `TIMG_TOHI_REG` registers will remain unchanged for the CPU to read in its own time until `TIMG_TOUPDATE_REG` is written to again.

13.3.3 Alarm Generation

A timer can be configured to trigger an alarm when the timer's current value matches the alarm value. An alarm will cause an interrupt to occur and (optionally) an automatic reload of the timer's current value (see Section 13.3.4).

The 54-bit alarm value is configured using `TIMG_TOALARMLO_REG` and `TIMG_TOALARMHI_REG`, which represent the lower 32-bits and higher 22-bits of the alarm value, respectively. However, the configured alarm value is ineffective until the alarm is enabled by setting the `TIMG_TO_ALARM_EN` field. To avoid alarm being enabled "too late" (i.e. the timer value has already passed the alarm value when the alarm is enabled), the hardware will trigger the alarm immediately if the current timer value is:

- higher than the alarm value (within a defined range) when the up-down counter increments
- lower than the alarm value (within a defined range) when the up-down counter decrements

Table 13-1 and Table 13-2 show the relationship between the current value of the timer, the alarm value, and when an alarm is triggered. The current time value and the alarm value are defined as follows:

- `TIMG_VALUE` = {`TIMG_TOHI_REG`, `TIMG_TOLO_REG`}
- `ALARM_VALUE` = {`TIMG_TOALARMHI_REG`, `TIMG_TOALARMLO_REG`}

Table 13-1. Alarm Generation When Up-Down Counter Increments

Scenario	Range	Alarm
1	$ALARM_VALUE - TIMG_VALUE > 2^{53}$	Triggered
2	$0 < ALARM_VALUE - TIMG_VALUE \leq 2^{53}$	Triggered when the up-down counter counts <code>TIMG_VALUE</code> up to <code>ALARM_VALUE</code>
3	$0 \leq TIMG_VALUE - ALARM_VALUE < 2^{53}$	Triggered
4	$TIMG_VALUE - ALARM_VALUE \geq 2^{53}$	Triggered when the up-down counter restarts counting up from 0 after reaching the timer's maximum value and counts <code>TIMG_VALUE</code> up to <code>ALARM_VALUE</code>

Table 13-2. Alarm Generation When Up-Down Counter Decrements

Scenario	Range	Alarm
5	$TIMG_VALUE - ALARM_VALUE > 2^{53}$	Triggered
6	$0 < TIMG_VALUE - ALARM_VALUE \leq 2^{53}$	Triggered when the up-down counter counts $TIMG_VALUE$ down to $ALARM_VALUE$
7	$0 \leq ALARM_VALUE - TIMG_VALUE < 2^{53}$	Triggered
8	$ALARM_VALUE - TIMG_VALUE \geq 2^{53}$	Triggered when the up-down counter restarts counting down from the timer's maximum value after reaching the minimum value and counts $TIMG_VALUE$ down to $ALARM_VALUE$

When an alarm occurs, the [TIMG_T0_ALARM_EN](#) field is automatically cleared and no alarm will occur again until the [TIMG_T0_ALARM_EN](#) is set next time.

13.3.4 Timer Reload

A timer is reloaded when a timer's current value is overwritten with a reload value stored in the [TIMG_T0_LOAD_LO](#) and [TIMG_T0_LOAD_HI](#) fields that correspond to the lower 32-bits and higher 22-bits of the timer's new value, respectively. However, writing a reload value to [TIMG_T0_LOAD_LO](#) and [TIMG_T0_LOAD_HI](#) will not cause the timer's current value to change. Instead, the reload value is ignored by the timer until a reload event occurs. A reload event can be triggered either by a software instant reload or an auto-reload at alarm.

A software instant reload is triggered by the CPU writing any value to [TIMG_T0LOAD_REG](#), which causes the timer's current value to be instantly reloaded. If [TIMG_T0_EN](#) is set, the timer will continue incrementing or decrementing from the new value. In this case if [TIMG_T0_ALARM_EN](#) is set, the timer will still trigger alarms in scenarios listed in Table 13-1 and 13-2. If [TIMG_T0_EN](#) is cleared, the timer will remain frozen at the new value until counting is re-enabled.

An auto-reload at alarm will cause a timer reload when an alarm occurs, thus allowing the timer to continue incrementing or decrementing from the reload value. This is generally useful for resetting the timer's value when using periodic alarms. To enable auto-reload at alarm, the [TIMG_T0_AUTORELOAD](#) field should be set. If not enabled, the timer's value will continue to increment or decrement past the alarm value after an alarm.

13.3.5 Event Task Matrix Function

In addition to using the APB (Advanced Peripheral Bus) method described above for configuring timer groups, some functions of the timer group can also be triggered by tasks generated by the Event Task Matrix (ETM) module. An ETM task is a pulse signal from the ETM module, and its original signal may come from the events of other modules or the events of its own module. Please refer to chapter 11 [Event Task Matrix \(SOC_ETM\)](#) for more details.

ETM tasks can help set up some specific functions without CPU involvement. The following ETM tasks are available for configuring timer groups.

- [TIMER_n_TASK_CNT_START_TIMER0](#) (*n*:0-1): When triggered, it will enable the time-base counter.
- [TIMER_n_TASK_CNT_STOP_TIMER0](#) (*n*:0-1): When triggered, it will disable the time-base counter.

Note:

The above two ETM tasks have the same function as the APB configuration [TIMG_TO_EN](#). When these operations occur at the same time, the priority of each operation from high to low is as follows:

1. `TIMER n _TASK_CNT_START_TIMER0`: When triggered, it will enable the time-base counter;
2. `TIMER n _TASK_CNT_STOP_TIMER0`: When triggered, it will disable the time-base counter;
3. APB configuration [TIMG_TO_EN](#): When triggered, it will enable or disable the time-base counter.

- `TIMER n _TASK_ALARM_START_TIMER0` (n :0-1): When triggered, it will enable the alarm generation.

Note:

Alarm generation can also be configured through APB method and hardware events. When these operations occur at the same time, the priority of each operation from high to low is as follows:

1. `TIMER n _TASK_ALARM_START_TIMER0`: When triggered, it will enable the alarm generation;
2. Alarm events: When triggered, it will disable the alarm generation;
3. APB configuration `TIMG_ALARM_EN`: When triggered, it will enable or disable the alarm generation.

- `TIMER n _TASK_CNT_CAP_TIMER0` (n :0-1): When triggered, it will update the current counter value to the [TIMG_TOLO_REG](#) and [TIMG_TOHI_REG](#) registers.
- `TIMER n _TASK_CNT_RELOAD_TIMER0` (n :0-1): When triggered, it will overwrite the current counter value with the reload value stored in [TIMG_TO_LOAD_LO](#) and [TIMG_TO_LOAD_HI](#).

Timer groups also have ETM events that drive tasks of their own or other modules. Timer groups trigger `TIMER n _EVT_CNT_CMP_TIMER0` (n :0-1) by the alarm pulses.

All the ETM tasks and events will not take effect until the [TIMG_ETM_EN](#) is set to 1.

As mentioned above, a module's events can trigger its own tasks. For example, `TIMER n _TASK_ALARM_START_TIMER0` (n :0-1) can be triggered by `TIMER n _EVT_CNT_CMP_TIMER0` (n :0-1) to realize periodic alarm. For configuration steps, please refer to [13.4.4 Timer as Periodic Alarm by ETM](#).

13.3.6 RTC_SLOW_CLK Frequency Calculation

Using `XTAL_CLK` as a reference, it is possible to calculate the frequency of clock sources for `RTC_SLOW_CLK` (i.e. `RC_SLOW_CLK`, `RC_FAST_DIV_CLK`, and `XTAL32K_CLK`) as follows:

1. Start periodic or one-shot frequency calculation (see Section [13.4.5](#) for details);
2. Once receiving the signal to start calculation, the counter of `XTAL_CLK` and the counter of `RTC_SLOW_CLK` begin to work at the same time. When the counter of `RTC_SLOW_CLK` counts to `C0`, the two counters stop counting simultaneously;
3. Assume the value of `XTAL_CLK`'s counter is `C1`, and the frequency of `RTC_SLOW_CLK` would be calculated as: $f_{rtc} = \frac{C0 \times f_{XTAL_CLK}}{C1}$

13.3.7 Interrupts

Each timer has its own interrupt line that can be routed to the CPU, and thus each timer group has a total of two interrupt lines. Timers generate level interrupts that must be explicitly cleared by the CPU on each

triggering.

Interrupts are triggered after an alarm (or stage timeout for watchdog timers) occurs. Level interrupts will be held high after an alarm (or stage timeout) occurs, and will remain so until manually cleared. To enable a timer's interrupt, the `TIMG_TO_INT_ENA` bit should be set.

The interrupts of each timer group are governed by a set of registers. Each timer within the group has a corresponding bit in each of these registers:

- `TIMG_TO_INT_RAW` : An alarm event sets it to 1. The bit will remain set until the timer's corresponding bit in `TIMG_TO_INT_CLR` is written.
- `TIMG_WDT_INT_RAW` : A stage time out will set the timer's bit to 1. The bit will remain set until the timer's corresponding bit in `TIMG_WDT_INT_CLR` is written.
- `TIMG_TO_INT_ST` : Reflects the status of each timer's interrupt and is generated by masking the bits of `TIMG_TO_INT_RAW` with `TIMG_TO_INT_ENA`.
- `TIMG_WDT_INT_ST` : Reflects the status of each watchdog timer's interrupt and is generated by masking the bits of `TIMG_WDT_INT_RAW` with `TIMG_WDT_INT_ENA`.
- `TIMG_TO_INT_ENA` : Used to enable or mask the interrupt status bits of timers within the group.
- `TIMG_WDT_INT_ENA` : Used to enable or mask the interrupt status bits of watchdog timer within the group.
- `TIMG_TO_INT_CLR` : Used to clear a timer's interrupt by setting its corresponding bit to 1. The timer's corresponding bit in `TIMG_TO_INT_RAW` and `TIMG_TO_INT_ST` will be cleared as a result. Note that a timer's interrupt must be cleared before the next interrupt occurs.
- `TIMG_WDT_INT_CLR` : Used to clear a timer's interrupt by setting its corresponding bit to 1. The watchdog timer's corresponding bit in `TIMG_WDT_INT_RAW` and `TIMG_WDT_INT_ST` will be cleared as a result. Note that a watchdog timer's interrupt must be cleared before the next interrupt occurs.

13.4 Configuration and Usage

13.4.1 Timer as a Simple Clock

1. Configure the time-base counter
 - Select clock source by setting or clearing `PCR_TG0_TIMER_CLK_SEL` field.
 - Configure the 16-bit prescaler by setting `TIMG_TO_DIVIDER`.
 - Configure the timer direction by setting or clearing `TIMG_TO_INCREASE`.
 - Set the timer's starting value by writing the starting value to `TIMG_TO_LOAD_LO` and `TIMG_TO_LOAD_HI`, then reloading it into the timer by writing any value to `TIMG_TOLOAD_REG`.
2. Start the timer by setting `TIMG_TO_EN`.
3. Get the timer's current value.
 - Write any value to `TIMG_TOUPDATE_REG` to latch the timer's current value.
 - Wait until `TIMG_TOUPDATE_REG` is cleared by hardware.
 - Read the latched timer value from `TIMG_TOLO_REG` and `TIMG_TOHI_REG`.

13.4.2 Timer as One-shot Alarm

1. Configure the time-base counter following step 1 of Section 13.4.1.
2. Configure the alarm.
 - Configure the alarm value by setting [TIMG_TOALARMLO_REG](#) and [TIMG_TOALARMHI_REG](#).
 - Enable interrupt by setting [TIMG_TO_INT_ENA](#).
3. Disable auto reload by clearing [TIMG_TO_AUTORELOAD](#).
4. Start the alarm by setting [TIMG_TO_ALARM_EN](#).
5. Handle the alarm interrupt.
 - Clear the interrupt by setting the timer's corresponding bit in [TIMG_TO_INT_CLR](#).
 - Disable the timer by clearing [TIMG_TO_EN](#).

13.4.3 Timer as Periodic Alarm by APB

1. Configure the time-base counter following step 1 in Section 13.4.1.
2. Configure the alarm following step 2 in Section 13.4.2.
3. Enable auto reload by setting [TIMG_TO_AUTORELOAD](#) and configure the reload value via [TIMG_TO_LOAD_LO](#) and [TIMG_TO_LOAD_HI](#).
4. Start the alarm by setting [TIMG_TO_ALARM_EN](#).
5. Handle the alarm interrupt (repeat on each alarm iteration).
 - Clear the interrupt by setting the timer's corresponding bit in [TIMG_TO_INT_CLR](#).
 - If the next alarm requires a new alarm value and reload value (i.e. different alarm interval per iteration), then [TIMG_TOALARMLO_REG](#), [TIMG_TOALARMHI_REG](#), [TIMG_TO_LOAD_LO](#), and [TIMG_TO_LOAD_HI](#) should be reconfigured as needed. Otherwise, the aforementioned registers should remain unchanged.
 - Re-enable the alarm by setting [TIMG_TO_ALARM_EN](#).
6. Stop the timer (on final alarm iteration).
 - Clear the interrupt by setting the timer's corresponding bit in [TIMG_TO_INT_CLR](#).
 - Disable the timer by clearing [TIMG_TO_EN](#).

13.4.4 Timer as Periodic Alarm by ETM

1. Enable the ETM module's clock
2. Map ETM event to ETM task (which means using the event to trigger the task)
 - If [TIMG_TO_AUTORELOAD](#) is set to 1, map [TIMER_n_EVT_CNT_CMP_TIMER0](#) ($n:0-1$) to the [TIMER_n_TASK_ALARM_START_TIMER0](#) ($n:0-1$) by one ETM channel.
 - If [TIMG_TO_AUTORELOAD](#) is set to 0, in addition to mapping [TIMER_n_EVT_CNT_CMP_TIMER0](#) ($n:0-1$) to the [TIMER_n_TASK_ALARM_START_TIMER0](#) ($n:0-1$), the [TIMER_n_EVT_CNT_CMP_TIMER0](#) ($n:0-1$) to the [TIMER_n_TASK_ALARM_START_TIMER0](#) ($n:0-1$), the [TIMER_n_EVT_CNT_CMP_TIMER0](#) ($n:0-1$) to the [TIMER_n_TASK_ALARM_START_TIMER0](#) ($n:0-1$), the [TIMER_n_EVT_CNT_CMP_TIMER0](#) ($n:0-1$) to the [TIMER_n_TASK_ALARM_START_TIMER0](#) ($n:0-1$).

($n:0-1$) should also be mapped to `TIMER n _TASK_CNT_RELOAD_TIMER0` ($n:0-1$) by another ETM channel.

3. Choose to enable the one or two ETM channels.
4. Set `TIMER_ETM_EN` to 1 to enable timer group's ETM events and tasks.
5. Configure the time-base counter following step 1 in Section 13.4.1.
6. Configure the alarm following step 2 in Section 13.4.2.
7. Configure the reload value via `TIMG_TO_LOAD_LO` and `TIMG_TO_LOAD_HI`.
8. Handle the `TIMER n _EVT_CNT_CMP_TIMER0` ($n:0-1$).
 - When alarm generates, the `TIMER n _EVT_CNT_CMP_TIMER0` ($n:0-1$) also generates, and the alarm generation will be disabled by the alarm.
 - If `TIMG_TO_AUTORELOAD` is 1, the current counter value is overwritten by the reloaded value. The alarm generation will be reopened by `TIMER n _TASK_ALARM_START_TIMER0` ($n:0-1$).
 - If `TIMG_TO_AUTORELOAD` is 0, the current counter value is overwritten by the reloaded value because of the `TIMER n _TASK_CNT_RELOAD_TIMER0` ($n:0-1$). The alarm generation will be reopened by `TIMER n _TASK_ALARM_START_TIMER0` ($n:0-1$).
9. Stop the timer (on final alarm iteration).
 - Disable the ETM channels used to map timer group's event and task
 - Set `TIMER_ETM_EN` to 0.
 - Clear the interrupt by setting the timer's corresponding bit in `TIMG_TO_INT_CLR`.
 - Disable the timer by clearing `TIMG_TO_EN`.

13.4.5 RTC_SLOW_CLK Frequency Calculation

1. One-shot frequency calculation
 - Select the clock whose frequency is to be calculated (clock source of `RTC_SLOW_CLK`) via `TIMG_RTC_CALI_CLK_SEL`, and configure the time of calculation via `TIMG_RTC_CALI_MAX`.
 - Select one-shot frequency calculation by clearing `TIMG_RTC_CALI_START_CYCLING`, and enable the two counters via `TIMG_RTC_CALI_START`.
 - Once `TIMG_RTC_CALI_RDY` becomes 1, read `TIMG_RTC_CALI_VALUE` to get the value of `XTAL_CLK`'s counter, and calculate the frequency of `RTC_SLOW_CLK` according to the formula in Section 13.3.6.
2. Periodic frequency calculation
 - Select the clock whose frequency is to be calculated (clock source of `RTC_SLOW_CLK`) via `TIMG_RTC_CALI_CLK_SEL`, and configure the time of calculation via `TIMG_RTC_CALI_MAX`.
 - Select periodic frequency calculation by enabling `TIMG_RTC_CALI_START_CYCLING`.
 - When `TIMG_RTC_CALI_CYCLING_DATA_VLD` is 1, `TIMG_RTC_CALI_VALUE` is valid.
3. Timeout

If the counter of `RTC_SLOW_CLK` cannot finish counting in `TIMG_RTC_CALI_TIMEOUT_RST_CNT` cycles,

`TIMG_RTC_CALI_TIMEOUT` will be set to indicate a timeout.

13.5 Register Summary

The addresses in this section are relative to **Timer Group** base address provided in Table 5-2 in Chapter 5 *System and Memory*.

The abbreviations given in Column **Access** are explained in Section *Access Types for Registers*.

Name	Description	Address	Access
T0 control and configuration registers			
TIMG_T0CONFIG_REG	Timer 0 configuration register	0x0000	varies
TIMG_T0LO_REG	Timer 0 current value, low 32 bits	0x0004	RO
TIMG_T0HI_REG	Timer 0 current value, high 22 bits	0x0008	RO
TIMG_T0UPDATE_REG	Write to copy current timer value to TIMGn_T0LO_REG or TIMGn_T0HI_REG	0x000C	R/W/SC
TIMG_T0ALARMLO_REG	Timer 0 alarm value, low 32 bits	0x0010	R/W
TIMG_T0ALARMHI_REG	Timer 0 alarm value, high bits	0x0014	R/W
TIMG_T0LOADLO_REG	Timer 0 reload value, low 32 bits	0x0018	R/W
TIMG_T0LOADHI_REG	Timer 0 reload value, high 22 bits	0x001C	R/W
TIMG_T0LOAD_REG	Write to reload timer from TIMG_T0LOADLO_REG or TIMG_T0LOADHI_REG	0x0020	WT
WDT control and configuration registers			
TIMG_WDTCONFIG0_REG	Watchdog timer configuration register	0x0048	varies
TIMG_WDTCONFIG1_REG	Watchdog timer prescaler register	0x004C	varies
TIMG_WDTCONFIG2_REG	Watchdog timer stage 0 timeout value	0x0050	R/W
TIMG_WDTCONFIG3_REG	Watchdog timer stage 1 timeout value	0x0054	R/W
TIMG_WDTCONFIG4_REG	Watchdog timer stage 2 timeout value	0x0058	R/W
TIMG_WDTCONFIG5_REG	Watchdog timer stage 3 timeout value	0x005C	R/W
TIMG_WDTFEED_REG	Write to feed the watchdog timer	0x0060	WT
TIMG_WDTWPROTECT_REG	Watchdog write protect register	0x0064	R/W
RTC frequency calculation control and configuration registers			
TIMG_RTCCALICFG_REG	RTC frequency calculation configuration register 0	0x0068	varies
TIMG_RTCCALICFG1_REG	RTC frequency calculation configuration register 1	0x006C	RO
TIMG_RTCCALICFG2_REG	RTC frequency calculation configuration register 2	0x0080	varies
Interrupt registers			
TIMG_INT_ENA_TIMERS_REG	Interrupt enable bits	0x0070	R/W
TIMG_INT_RAW_TIMERS_REG	Raw interrupt status	0x0074	R/SS/WTC
TIMG_INT_ST_TIMERS_REG	Masked interrupt status	0x0078	RO
TIMG_INT_CLR_TIMERS_REG	Interrupt clear bits	0x007C	WT
Version register			
TIMG_NTIMERS_DATE_REG	Timer version control register	0x00F8	R/W
Clock configuration registers			
TIMG_REGCLK_REG	Timer group clock gate register	0x00FC	R/W

13.6 Registers

The addresses in this section are relative to **Timer Group** base address provided in Table 5-2 in Chapter 5 *System and Memory*.

Register 13.1. TIMG_T0CONFIG_REG (0x0000)

TIMG_T0_EN TIMG_T0_INCREASE TIMG_T0_AUTORELOAD				TIMG_T0_DIVIDER				TIMG_T0_DIVCNT_RST (reserved) TIMG_T0_ALARM_EN				(reserved)					
31	30	29	28	13	12	11	10	9									
0	1	1		0x01				0	0	0	0	0	0	0	0	0	Reset

TIMG_T0_ALARM_EN Configures whether or not to enable the timer 0 alarm function. This bit will be automatically cleared once an alarm occurs.

0: Disable

1: Enable

(R/W/SC)

TIMG_T0_DIVCNT_RST Configures whether or not to reset the timer 0 's clock divider counter.

0: No effect

1: Reset

(WT)

TIMG_T0_DIVIDER Represents the timer 0 clock (T0_clk) prescaler value. (R/W)

TIMG_T0_AUTORELOAD Configures whether or not to enable the timer 0 auto-reload function at the time of alarm.

0: No effect

1: Enable

(R/W)

TIMG_T0_INCREASE Configures the counting direction of the timer 0 time-base counter.

0: Decrement

1: Increment

(R/W)

TIMG_T0_EN Configures whether or not to enable the timer 0 time-base counter.

0: Disable

1: Enable

(R/W/SS/SC)

Register 13.2. TIMG_T0LO_REG (0x0004)

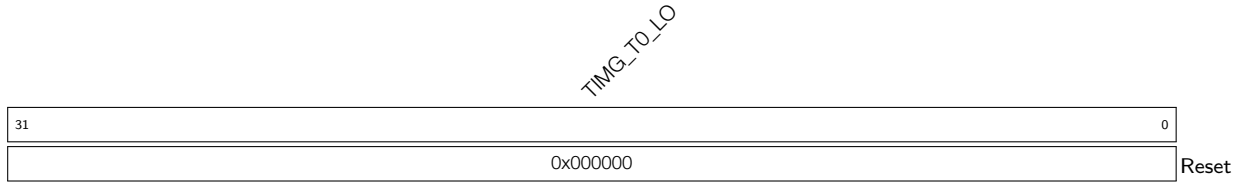

TIMG_TO_LO Represents the low 32 bits of the time-base counter of timer 0. Valid only after writing to [TIMG_T0UPDATE_REG](#).
 Measurement unit: TO_clk.
 (RO)

Register 13.3. TIMG_T0HI_REG (0x0008)

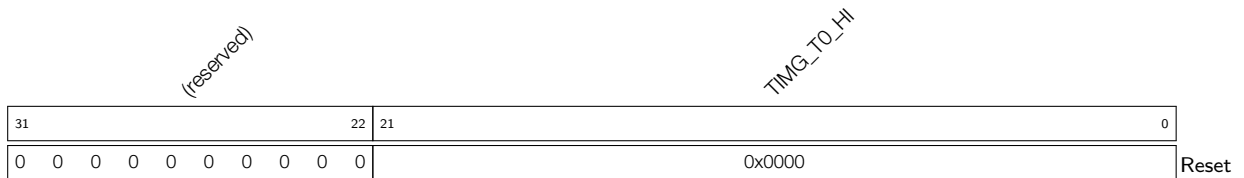

TIMG_TO_HI Represents the high 22 bits of the time-base counter of timer 0. Valid only after writing to [TIMG_T0UPDATE_REG](#).
 Measurement unit: TO_clk.
 (RO)

Register 13.4. TIMG_T0UPDATE_REG (0x000C)

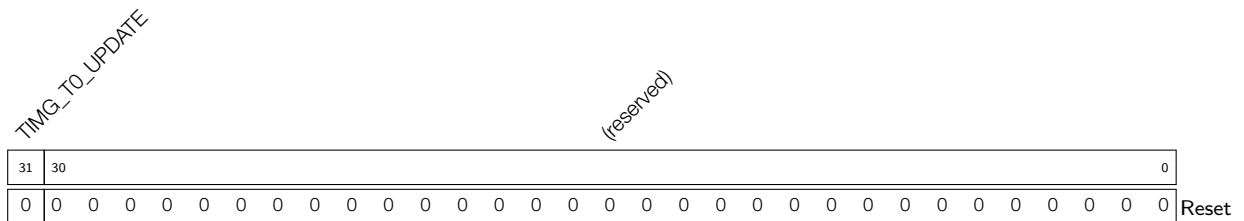

TIMG_TO_UPDATE Configures to latch the counter value.
 0: Latch
 1: Latch
 (R/W/SC)

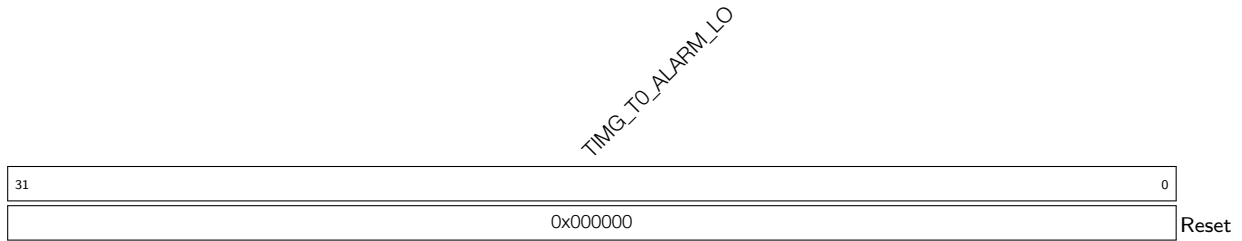
Register 13.5. TIMG_T0ALARMLO_REG (0x0010)

TIMG_T0_ALARM_LO Configures the low 32 bits of timer 0 alarm trigger time-base counter value.

Valid only when [TIMG_T0_ALARM_EN](#) is 1.

Measurement unit: TO_clk.

(R/W)

Register 13.6. TIMG_T0ALARMHI_REG (0x0014)

TIMG_T0_ALARM_HI Configures the high 22 bits of timer 0 alarm trigger time-base counter value.

Valid only when [TIMG_T0_ALARM_EN](#) is 1.

Measurement unit: TO_clk.

(R/W)

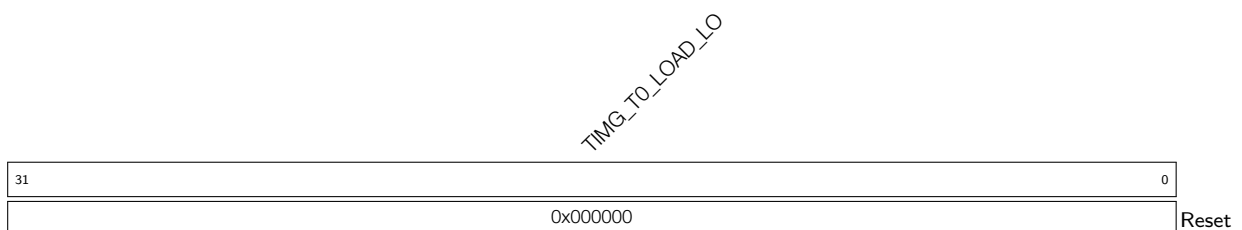
Register 13.7. TIMG_T0LOADLO_REG (0x0018)

TIMG_T0_LOAD_LO Configures low 32 bits of the value that a reload will load onto timer 0 time-base counter.

Measurement unit: TO_clk.

(R/W)

Register 13.8. TIMG_T0LOADHI_REG (0x001C)

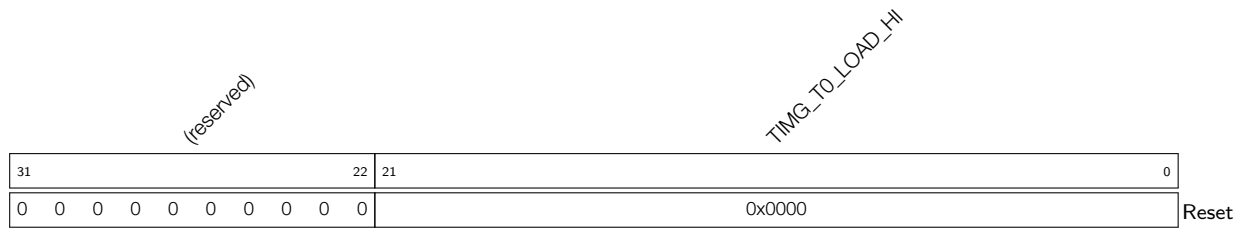

TIMG_T0_LOAD_HI Configures high 22 bits of the value that a reload will load onto timer 0 time-base counter.

Measurement unit: TO_clk.

(R/W)

Register 13.9. TIMG_T0LOAD_REG (0x0020)

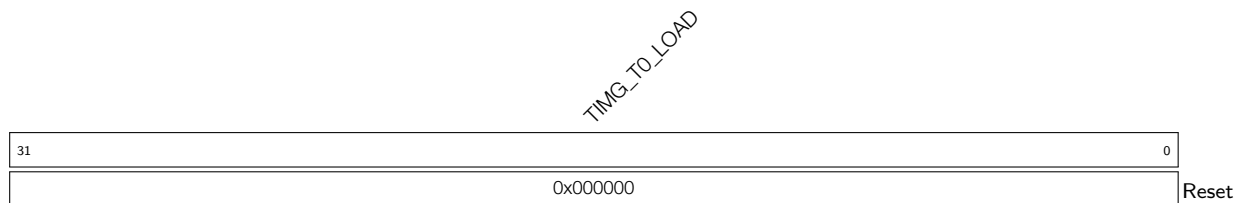

TIMG_T0_LOAD Write any value to trigger a timer 0 time-base counter reload. (WT)

Register 13.10. TIMG_WDTCONFIG0_REG (0x0048)

TIMG_WDT_EN		TIMG_WDT_STG0		TIMG_WDT_STG1		TIMG_WDT_STG2		TIMG_WDT_STG3		TIMG_WDT_CONF_UPDATE_EN		TIMG_WDT_CPU_RESET_LENGTH		TIMG_WDT_SYS_RESET_LENGTH		TIMG_WDT_FLASHBOOT_MOD_EN		TIMG_WDT_PROCPU_RESET_EN		TIMG_WDT_APPCPU_RESET_EN		(reserved)				
31	30	29	28	27	26	25	24	23	22	21	20	18	17	15	14	13	12	11				0				
0	0	0	0	0	0	0	0	0	0	0	0x1	0x1	1	0	0	0	0	0	0	0	0	0	0	0	0	Reset

TIMG_WDT_APPCPU_RESET_EN Configures whether to mask the CPU reset generated by MWDT.

Valid only when write protection is disabled.

0: Mask

1: Unmask

(R/W)

TIMG_WDT_PROCPU_RESET_EN Configures whether to mask the CPU reset generated by MWDT.

Valid only when write protection is disabled.

0: Mask

1: Unmask

(R/W)

TIMG_WDT_FLASHBOOT_MOD_EN Configures whether to enable flash boot protection.

0: Disable

1: Enable

(R/W)

TIMG_WDT_SYS_RESET_LENGTH Configures the system reset signal length. Valid only when write protection is disabled.

Measurement unit: mwdt_clk.

0: 8

4: 40

1: 16

5: 64

2: 24

6: 128

3: 32

7: 256

(R/W)

Continued on the next page...

Register 13.10. TIMG_WDTCONFIG0_REG (0x0048)

Continued from the previous page...

TIMG_WDT_CPU_RESET_LENGTH Configures the CPU reset signal length. Valid only when write protection is disabled.

Measurement unit: mwdt_clk.

0: 8	4: 40
1: 16	5: 64
2: 24	6: 128
3: 32	7: 256

(R/W)

TIMG_WDT_CONF_UPDATE_EN Configures to update the WDT configuration registers.

0: No effect

1: Update

(WT)

TIMG_WDT_STG3 Configures the timeout action of stage 3. See details in [TIMG_WDT_STG0](#). Valid only when write protection is disabled. (R/W)

TIMG_WDT_STG2 Configures the timeout action of stage 2. See details in [TIMG_WDT_STG0](#). Valid only when write protection is disabled. (R/W)

TIMG_WDT_STG1 Configures the timeout action of stage 1. See details in [TIMG_WDT_STG0](#). Valid only when write protection is disabled. (R/W)

TIMG_WDT_STG0 Configures the timeout action of stage 0. Valid only when write protection is disabled.

0: No effect

1: Interrupt

2: Reset CPU

3: Reset system

(R/W)

TIMG_WDT_EN Configures whether or not to enable the MWDT. Valid only when write protection is disabled.

0: Disable

1: Enable

(R/W)

Register 13.11. TIMG_WDTCONFIG1_REG (0x004C)

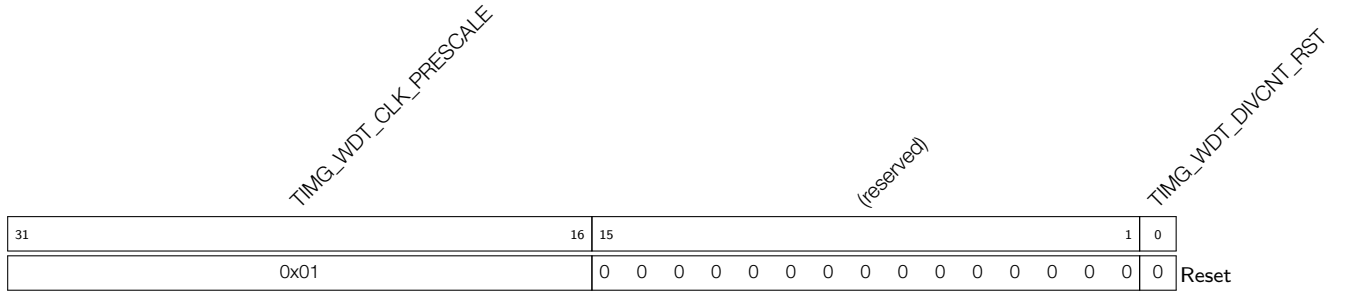

TIMG_WDT_DIVCNT_RST Configures whether to reset WDT 's clock divider counter.

- 0: No effect
- 1: Reset (WT)

TIMG_WDT_CLK_PRESCALE Configures MWDT clock prescaler value. Valid only when write protection is disabled.

MWDT clock period = MWDT's clock source period * TIMG_WDT_CLK_PRESCALE.
(R/W)

Register 13.12. TIMG_WDTCONFIG2_REG (0x0050)

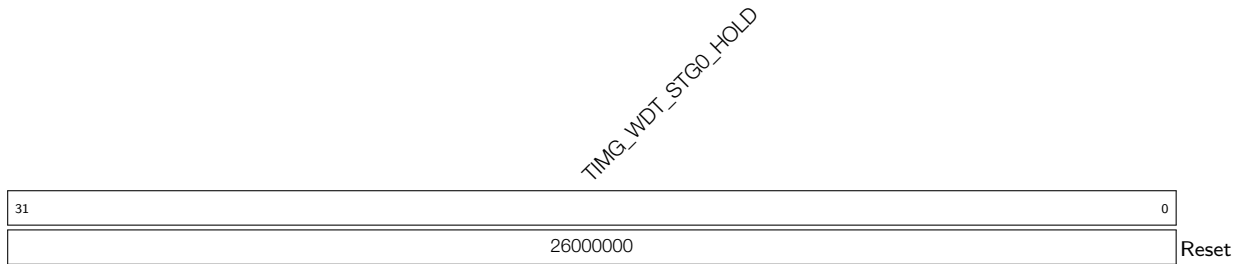

TIMG_WDT_STG0_HOLD Configures the stage 0 timeout value. Valid only when write protection is disabled.

Measurement unit: mwdt_clk.
(R/W)

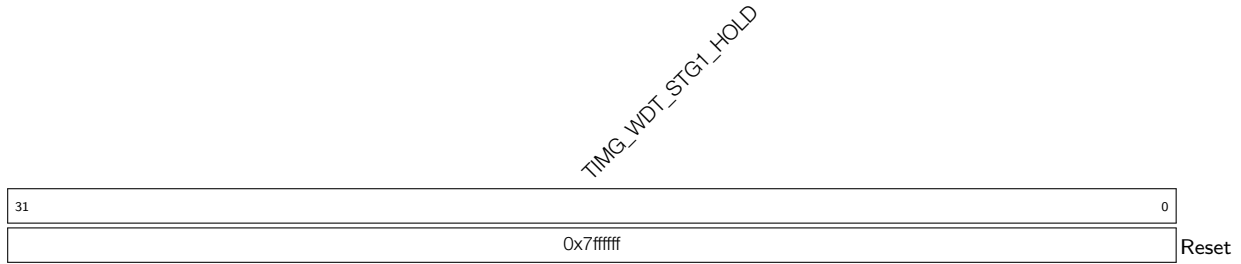
Register 13.13. TIMG_WDTCONFIG3_REG (0x0054)

TIMG_WDT_STG1_HOLD Configures the stage 1 timeout value. Valid only when write protection is disabled.

Measurement unit: mwdt_clk.

(R/W)

Register 13.14. TIMG_WDTCONFIG4_REG (0x0058)

TIMG_WDT_STG2_HOLD Configures the stage 2 timeout value. Valid only when write protection is disabled.

Measurement unit: mwdt_clk.

(R/W)

Register 13.15. TIMG_WDTCONFIG5_REG (0x005C)

TIMG_WDT_STG3_HOLD Configures the stage 3 timeout value. Valid only when write protection is disabled.

Measurement unit: mwdt_clk.

(R/W)

Register 13.16. TIMG_WDTFEED_REG (0x0060)

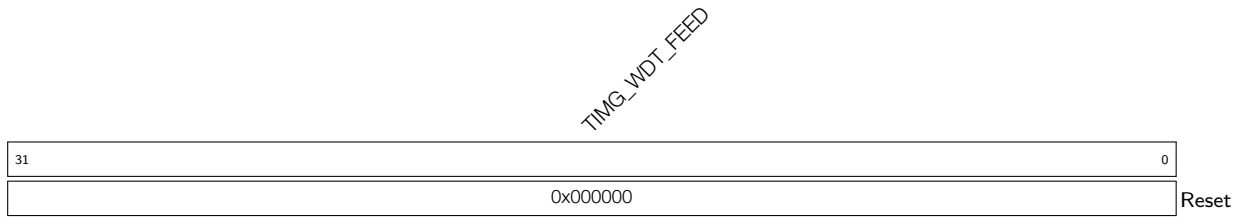

TIMG_WDT_FEED Write any value to feed the MWDT. Valid only when write protection is disabled.
(WT)

Register 13.17. TIMG_WDTWPROTECT_REG (0x0064)

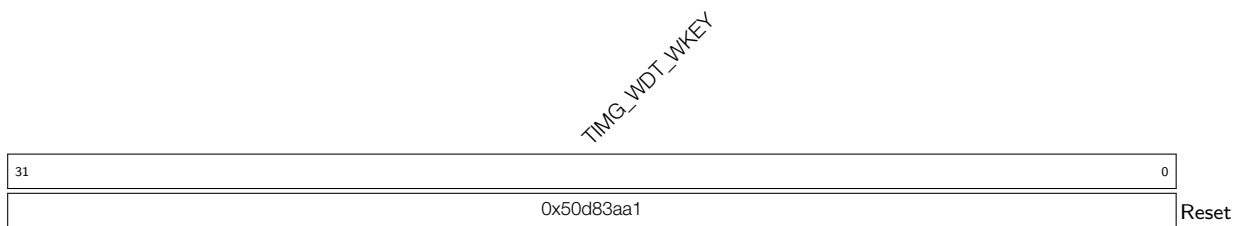

TIMG_WDT_WKEY Configures a different value than its reset value to enable write protection. (R/W)

Register 13.18. TIMG_RTCCALICFG_REG (0x0068)

TIMG_RTC_CALI_START						TIMG_RTC_CALI_MAX				TIMG_RTC_CALI_RDY				TIMG_RTC_CALI_CLK_SEL				TIMG_RTC_CALI_START_CYCLING				(reserved)							
31	30					16	15	14	13	12	11									0									
0	0x01				0	0	0	1	0	0	0	0	0	0	0	0	0	0	0	0	0	0	0	0	0	0	0	0	Reset

TIMG_RTC_CALI_START_CYCLING Configures the frequency calculation mode.

0: one-shot frequency calculation

1: periodic frequency calculation.

(R/W)

TIMG_RTC_CALI_CLK_SEL Configures to select the clock to be calibrated

0 RTC_SLOW_CLK

1 RC_FAST_DIV_CLK

2 XTAL32K_CLK

(R/W)

TIMG_RTC_CALI_RDY Represents whether one-shot frequency calculation is done.

0: Not done

1: Done

(RO)

TIMG_RTC_CALI_MAX Configures the time to calculate RTC slow clock's frequency.

Measurement unit: XTAL_CLK.

(R/W)

TIMG_RTC_CALI_START Configures whether to enable one-shot frequency calculation.

0: Disable

1: Enable

(R/W)

Register 13.19. TIMG_RTCCALICFG1_REG (0x006C)



TIMG_RTC_CALI_CYCLING_DATA_VLD Represents whether periodic frequency calculation is done.

0: Not done

1: Done

(RO)

TIMG_RTC_CALI_VALUE Represents the value countered by XTAL_CLK when one-shot or periodic frequency calculation is done. It is used to calculate RTC slow clock's frequency. (RO)

Register 13.20. TIMG_RTCCALICFG2_REG (0x0080)

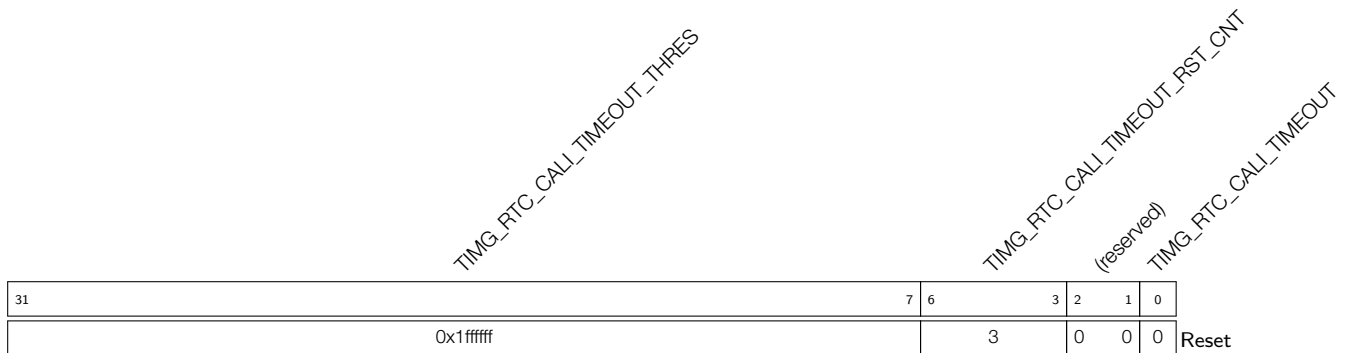

TIMG_RTC_CALI_TIMEOUT Represents whether RTC frequency calculation is timeout.

0: No timeout

1: Timeout

(RO)

TIMG_RTC_CALI_TIMEOUT_RST_CNT Configures the cycles that reset frequency calculation time-out.

Measurement unit: XTAL_CLK.

(R/W)

TIMG_RTC_CALI_TIMEOUT_THRES Configures the threshold value for the RTC frequency calculation timer. If the timer's value exceeds this threshold, a timeout is triggered.

Measurement unit: XTAL_CLK.

(R/W)

Register 13.24. TIMG_INT_CLR_TIMERS_REG (0x007C)

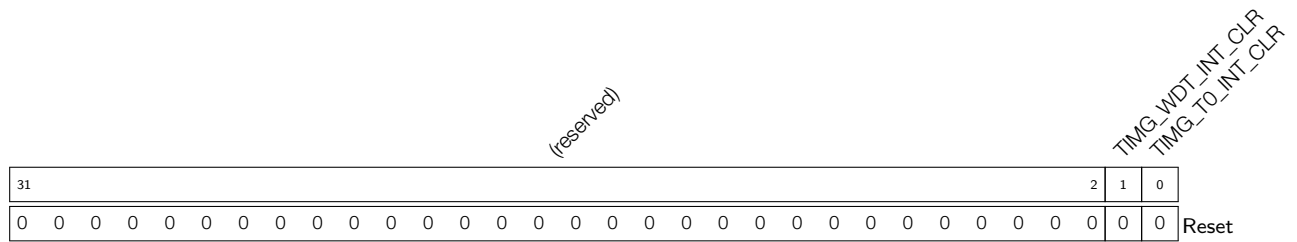

TIMG_TO_INT_CLR Write 1 to clear the TIMG_TO_INT interrupt. (WT)

TIMG_WDT_INT_CLR Write 1 to clear the TIMG_WDT_INT interrupt. (WT)

Register 13.25. TIMG_NTIMERS_DATE_REG (0x00F8)

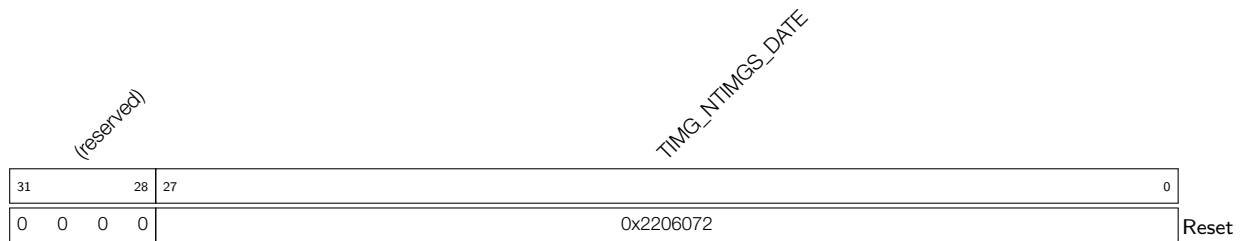

TIMG_NTIMGS_DATE Version control register (R/W)

14 Watchdog Timers (WDT)

14.1 Overview

Watchdog timers are hardware timers used to detect and recover from malfunctions. They must be periodically fed (reset) to prevent a timeout. A system/software that is behaving unexpectedly (e.g. is stuck in a software loop or in overdue events) will fail to feed the watchdog thus trigger a watchdog timeout. Therefore, watchdog timers are useful for detecting and handling erroneous system/software behavior.

As shown in Figure 14-1, ESP32-C6 contains three digital watchdog timers: one in each of the two timer groups in Chapter 13 *Timer Group (TIMG)* (called Main System Watchdog Timers, or MWDT) and one in the RTC Module (called the RTC Watchdog Timer, or RWDT). Each digital watchdog timer allows for four separately configurable stages and each stage can be programmed to take one action upon timeout, unless the watchdog is fed or disabled. MWDT supports three timeout actions: interrupt, CPU reset, and core reset, while RWDT supports four timeout actions: interrupt, CPU reset, core reset, and system reset (see details in Section 14.2.2.2 *Stages and Timeout Actions*). A timeout value can be set for each stage individually.

During the flash boot process, RWDT and the MWDT in timer group 0 are enabled automatically in order to detect and recover from booting errors.

ESP32-C6 also has one analog watchdog timer: Super watchdog (SWD). It is an ultra-low-power circuit in analog domain that helps to prevent the system from operating in a sub-optimal state and resets the system if required.

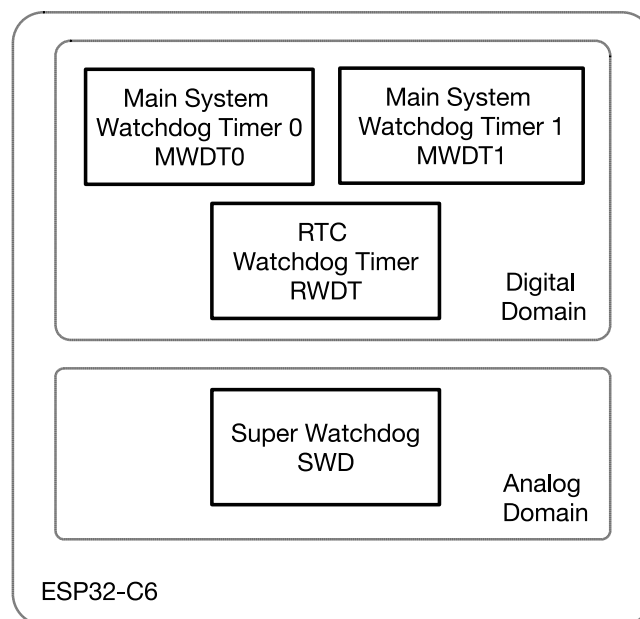

Figure 14-1. Watchdog Timers Overview

Note that while this chapter provides the functional descriptions of the watchdog timer's, MWDT register descriptions are detailed in Chapter 13 *Timer Group (TIMG)*, and the RWDT and SWD register descriptions are detailed in Section 14.5 *Register Summary*.

14.2 Digital Watchdog Timers

14.2.1 Features

Watchdog timers have the following features:

- Four stages, each with a separately programmable timeout value and timeout action
- Timeout actions:
 - MWDT: interrupt, CPU reset, core reset
 - RWDT: interrupt, CPU reset, core reset, system reset
- Flash boot protection at stage 0:
 - MWDT0: core reset upon timeout
 - RWDT: system reset upon timeout
- Write protection that makes WDT register read only unless unlocked
- 32-bit timeout counter
- Clock source:
 - MWDT: PLL_F80M_CLK, RC_FAST_CLK or XTAL_CLK
 - RWDT: RTC_SLOW_CLK

14.2.2 Functional Description

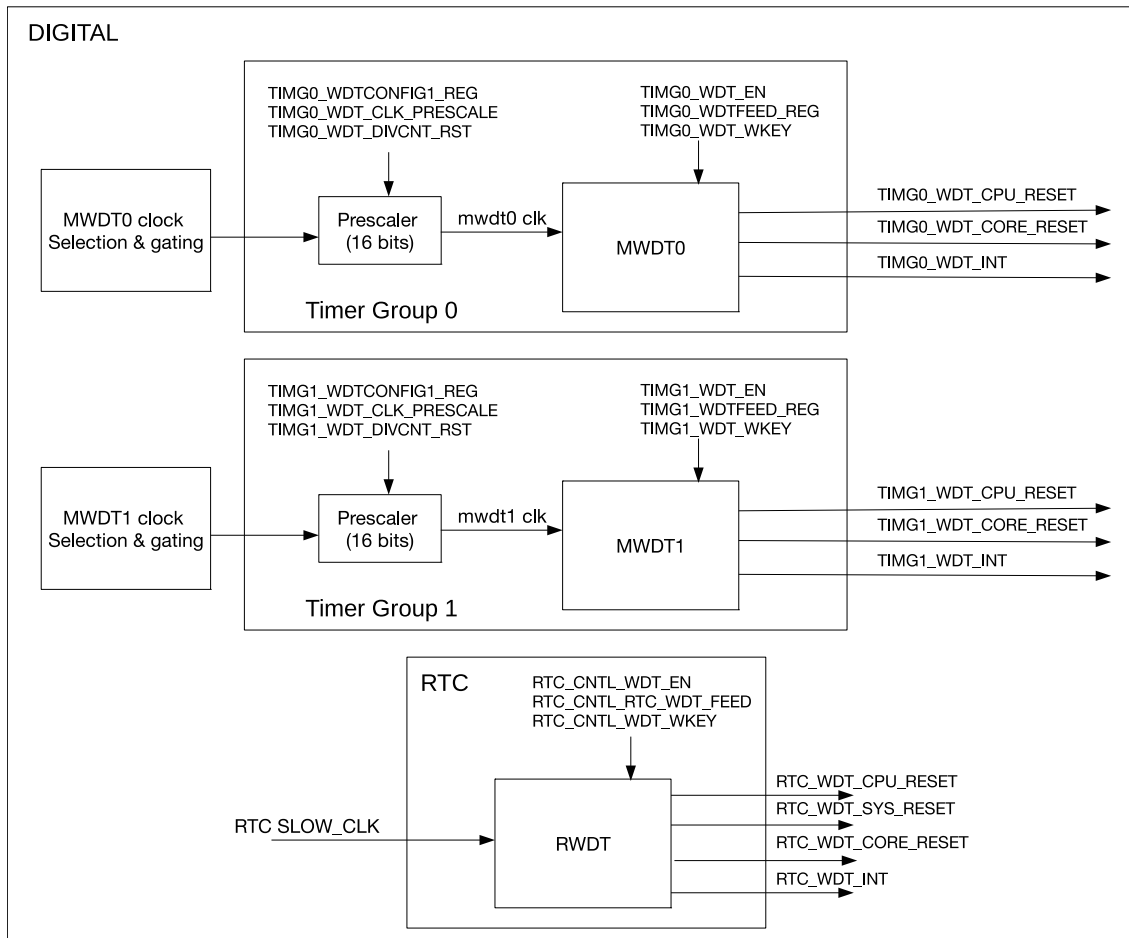

Figure 14-2. Digital Watchdog Timers in ESP32-C6

Figure 14-2 shows the three watchdog timers in ESP32-C6 digital systems.

14.2.2.1 Clock Source and 32-Bit Counter

At the core of each watchdog timer is a 32-bit counter.

Take MWD0 as an example:

- MWD0 can select between the PLL_F80M_CLK, RC_FAST_CLK or XTAL_CLK (external) clock as its clock source by setting the `PCR_TG0_WDT_CLK_SEL` field of the `PCR_TIMERGROUP0_WDT_CLK_CONF_REG` register.
- The selected clock is switched on by setting `PCR_TG0_WDT_CLK_EN` field of the `PCR_TIMERGROUP0_WDT_CLK_CONF_REG` register to 1 and switched off by setting it to 0. Then the selected clock is divided by a 16-bit configurable prescaler. See more details in Table 8-2 of Chapter 8.

The 16-bit prescaler for MWD0 is configured via the `TIMG_WDT_CLK_PRESCALE` field of `TIMG_WDTCONFIG1_REG`. When `TIMG_WDT_DIVCNT_RST` field is set, the prescaler is reset and it can be re-configured at once.

In contrast, the clock source of RWDT is derived directly from `RTC_SLOW_CLK` (see details in Chapter 8 *Reset and Clock*).

MWDT and RWDT are enabled by setting the `TIMG_WDT_EN` and `LP_WDT_RWDT_EN` fields respectively. When enabled, the 32-bit counters of the watchdog will increment on each source clock cycle until the timeout value of the current stage is reached (i.e. timeout of the current stage). When this occurs, the current counter value is reset to zero and the next stage will become active. If a watchdog timer is fed by software, the timer will return to stage 0 and reset its counter value to zero. Software can feed a watchdog timer by writing any value to `TIMG_WDTFEED_REG` for MDWT and by writing 1 to `LP_WDT_RWDT_FEED` for RWDT.

14.2.2.2 Stages and Timeout Actions

Timer stages allow for a timer to have a series of different timeout values and corresponding timeout action. When one stage times out, the timeout action is triggered, the counter value is reset to zero, and the next stage becomes active.

MWDT/RWDT provide four stages (called stages 0 to 3). The watchdog timers will progress through each stage in a loop (i.e. from stage 0 to 3, then back to stage 0).

Timeout values of each stage for MWDT are configured in `TIMG_WDTCONFIGi_REG` (where *i* ranges from 2 to 5), whilst timeout values for RWDT are configured using `LP_WDT_RWDT_STGj_HOLD` field (where *j* ranges from 0 to 3).

Please note that the timeout value of stage 0 for RWDT (T_{hold0}) is determined by the combination of the `EFUSE_WDT_DELAY_SEL` field of eFuse register `EFUSE_RD_REPEAT_DATA0_REG` and `LP_WDT_RWDT_STG0_HOLD` field. The relationship is as follows:

$$T_{hold0} = LP_WDT_RWDT_STG0_HOLD \ll (EFUSE_WDT_DELAY_SEL + 1)$$

where \ll is a left-shift operator. For example, if `LP_WDT_RWDT_STG0_HOLD` is configured as 100 and `EFUSE_WDT_DELAY_SEL` is 1, the T_{hold0} will be 400 cycles.

Upon the timeout of each stage, one of the following timeout actions will be executed:

Table 14-1. Timeout Actions

Timeout Action	Description
Interrupt	Trigger an interrupt
CPU reset	Reset the CPU core
Core reset	Reset the main system (which includes MWDT, CPU, and all peripherals). The power management unit and RTC peripherals will not be reset
System reset	Reset the main system, power management unit and RTC peripherals (see details in Chapter 2 <i>Low-Power Management [to be added later]</i>). This action is only available in RWDT
Disabled	No effect on the system

For MWDT, the timeout action of all stages is configured in `TIMG_WDTCONFIG0_REG`. Likewise for RWDT, the timeout action is configured in `LP_WDT_RWDT_CONFIG0_REG`.

14.2.2.3 Write Protection

Watchdog timers are critical to detecting and handling erroneous system/software behavior, thus should not be disabled easily (e.g. due to a misplaced register write). Therefore, MWDT and RWDT incorporate a write protection mechanism that prevent the watchdogs from being disabled or tampered with due to an accidental write.

The write protection mechanism is implemented using a write-key field for each timer ([TIMG_WDT_WKEY](#) for MWDT, [LP_WDT_RWDT_WKEY](#) for RWDT). The value 0x50D83AA1 must be written to the watchdog timer's write-key field before any other register of the same watchdog timer can be changed. Any attempts to write to a watchdog timer's registers (other than the write-key field itself) whilst the write-key field's value is not 0x50D83AA1 will be ignored. The recommended procedure for accessing a watchdog timer is as follows:

1. Disable the write protection by writing the value 0x50D83AA1 to the timer's write-key field.
2. Make the required modification of the watchdog such as feeding or changing its configuration.
3. Re-enable write protection by writing any value other than 0x50D83AA1 to the timer's write-key field.

14.2.2.4 Flash Boot Protection

During flash booting process, MWDT0 as well as RWDT, are automatically enabled. Stage 0 for the enabled MWDT0 is automatically configured as core reset action upon timeout, known as core reset. Likewise, stage 0 for RWDT is configured to system reset, which resets the main system and RTC when it times out. After booting, [TIMG_WDT_FLASHBOOT_MOD_EN](#) and [LP_WDT_RWDT_FLASHBOOT_MOD_EN](#) should be cleared to stop the flash boot protection procedure for both MWDT0 and RWDT respectively. After this, MWDT0 and RWDT can be configured by software.

14.3 Super Watchdog

Super watchdog (SWD) is an ultra-low-power circuit in analog domain that helps to prevent the system from operating in a sub-optimal state and resets the system (system reset) if required. SWD contains a watchdog circuit that needs to be fed for at least once during its timeout period, which is slightly less than one second. About 100 ms before watchdog timeout, it will also send out a WD_INTR signal as a request to remind the system to feed the watchdog.

If the system doesn't respond to SWD feed request and watchdog finally times out, SWD will generate a system level signal SWD_RSTB to reset whole digital circuits on the chip (system reset) .

The source of the clock for SWD is constant and can not be selected.

14.3.1 Features

SWD has the following features:

- Ultra-low power
- Interrupt to indicate that the SWD is about to time out
- Various dedicated methods for software to feed SWD, which enables SWD to monitor the working state of the whole operating system

PRELIMINARY

14.3.2 Super Watchdog Controller

14.3.2.1 Structure

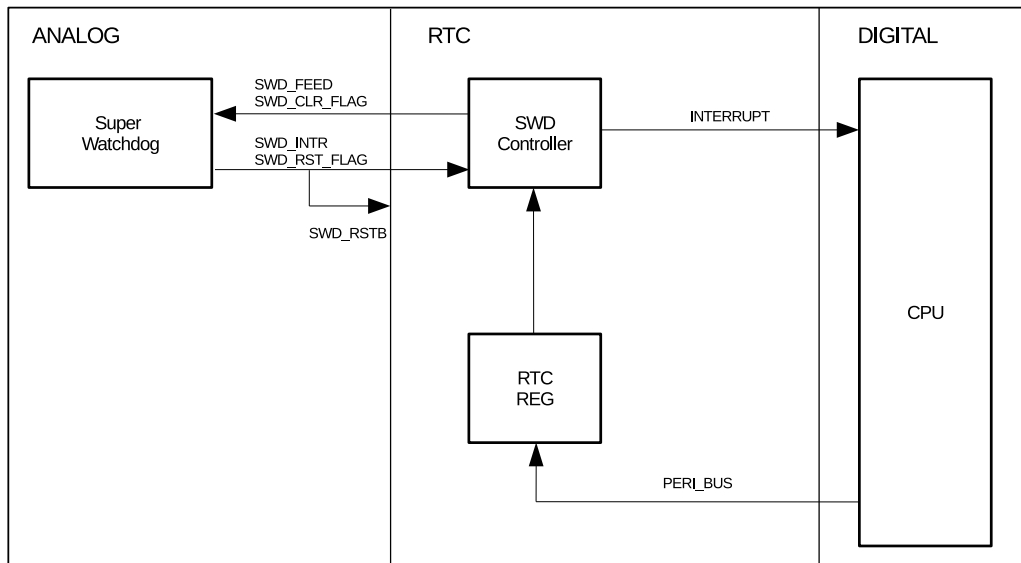

Figure 14-3. Super Watchdog Controller Structure

14.3.2.2 Workflow

In normal state:

- SWD controller receives feed request from SWD.
- SWD controller can send an interrupt to main CPU.
- Main CPU can feed SWD directly by setting `LP_WDT_SWD_FEED`.
- When trying to feed SWD, CPU needs to disable SWD controller's write protection by writing `0x50D83AA1` to `LP_WDT_SWD_WKEY`. This prevents SWD from being fed by mistake when the system is operating in sub-optimal state.
- If setting `LP_WDT_SWD_AUTO_FEED_EN` to 1, SWD controller can also feed SWD itself without any interaction with CPU.

After reset:

- Check `LP_CLKRST_RESET_CAUSE[4:0]` for the cause of CPU reset.
If `LP_CLKRST_RESET_CAUSE[4:0] == 0x12`, it indicates that the cause is SWD reset.
- Set `LP_WDT_SWD_RST_FLAG_CLR` to clear the SWD reset flag.

14.4 Interrupts

For watchdog timer interrupts, please refer to Section [13.3.7 Interrupts](#) in Chapter [13 Timer Group \(TIMG\)](#).

14.5 Register Summary

The addresses in this section are relative to LP_WDT base address provided in Table 5-2 in Chapter 5 *System and Memory*.

The abbreviations given in Column **Access** are explained in Section *Access Types for Registers*.

Name	Description	Address	Access
configuration register			
LP_WDT_RWDT_CONFIG0_REG	Configure the RWDT operation	0x0000	R/W
LP_WDT_RWDT_CONFIG1_REG	Configure the RWDT timeout time of stage0	0x0004	R/W
LP_WDT_RWDT_CONFIG2_REG	Configure the RWDT timeout time of stage1	0x0008	R/W
LP_WDT_RWDT_CONFIG3_REG	Configure the RWDT timeout time of stage2	0x000C	R/W
LP_WDT_RWDT_CONFIG4_REG	Configure the RWDT timeout time of stage3	0x0010	R/W
LP_WDT_RWDT_FEED_REG	Configure the feed function of RWDT	0x0014	WT
LP_WDT_RWDT_WPROTECT_REG	Configure the lock function of RWDT	0x0018	R/W
LP_WDT_SWDT_CONFIG_REG	Configure the SWD operation	0x001C	varies
LP_WDT_SWDT_WPROTECT_REG	Configure the lock function of SWD	0x0020	R/W
LP_WDT_INT_RAW_REG	The interrupt raw register of WDT	0x0024	R/WTC/SS
LP_WDT_INT_ST_REG	The interrupt status register of WDT	0x0028	RO
LP_WDT_INT_ENA_REG	The interrupt enable register of WDT	0x002C	R/W
LP_WDT_INT_CLR_REG	The interrupt clear register of WDT	0x0030	WT
LP_WDT_DATE_REG	Version control register	0x03FC	R/W

14.6 Registers

MWDT registers are part of the timer submodule and are described in Section 13.5 *Register Summary* in Chapter 13 *Timer Group (TIMG)*.

The addresses of RWDT and SWD registers in this section are relative to LP_WDT base address provided in Table 5-2 in Chapter 5 *System and Memory*.

Register 14.1. LP_WDT_RWDT_CONFIG0_REG (0x0000)

LP_WDT_RWDT_EN		LP_WDT_RWDT_STG0		LP_WDT_RWDT_STG1		LP_WDT_RWDT_STG2		LP_WDT_RWDT_STG3		LP_WDT_RWDT_CPU_RESET_LENGTH		LP_WDT_RWDT_SYS_RESET_LENGTH		LP_WDT_RWDT_FLASHBOOT_MOD_EN		LP_WDT_RWDT_PROCPU_RESET_EN		LP_WDT_RWDT_PAUSE_IN_SLP		(reserved)		
31	30	28	27	25	24	22	21	19	18	16	15	13	12	11	10	9	8					0
0	0x0	0x0	0x0	0x0	0x0	0x0	0x0	0x1	0x1	1	0	0	0	1	0	0	0	0	0	0	0	0

Reset

LP_WDT_RWDT_PAUSE_IN_SLP Configure whether or not pause RWDT when chip is in sleep mode.
 0: Enable
 1: Disable
 (R/W)

LP_WDT_RWDT_PROCPU_RESET_EN Configure whether or not to enable RWDT to reset CPU.
 0: Disable
 1: Enable
 (R/W)

LP_WDT_RWDT_FLASHBOOT_MOD_EN Configure whether or not to enable RWDT when chip is in SPI boot mode.
 0: Disable
 1: Enable
 (R/W)

LP_WDT_RWDT_SYS_RESET_LENGTH Configure the core reset time.
 Measurement unit: LP_DYN_FAST_CLK
 (R/W)

LP_WDT_RWDT_CPU_RESET_LENGTH Configure the CPU reset time.
 Measurement unit: LP_DYN_FAST_CLK
 (R/W)

LP_WDT_RWDT_STG3 Configure the timeout action of stage3.
 0: No operation
 1: Generate interrupt
 2: Generate CPU reset
 3: Generate core reset
 4: Generate system reset
 (R/W)

Continued on the next page...

Register 14.1. LP_WDT_RWDT_CONFIG0_REG (0x0000)

Continued from the previous page...

LP_WDT_RWDT_STG2 Configure the timeout action of stage2.

- 0: No operation
 - 1: Generate interrupt
 - 2: Generate CPU reset
 - 3: Generate core reset
 - 4: Generate system reset
- (R/W)

LP_WDT_RWDT_STG1 Configure the timeout action of stage1.

- 0: No operation
 - 1: Generate interrupt
 - 2: Generate CPU reset
 - 3: Generate core reset
 - 4: Generate system reset
- (R/W)

LP_WDT_RWDT_STG0 Configure the timeout action of stage0.

- 0: No operation
 - 1: Generate interrupt
 - 2: Generate CPU reset
 - 3: Generate core reset
 - 4: Generate system reset
- (R/W)

LP_WDT_RWDT_EN Configure whether or not enable RWDT.

- 0: Disable RWDT
 - 1: Enable RWDT
- (R/W)

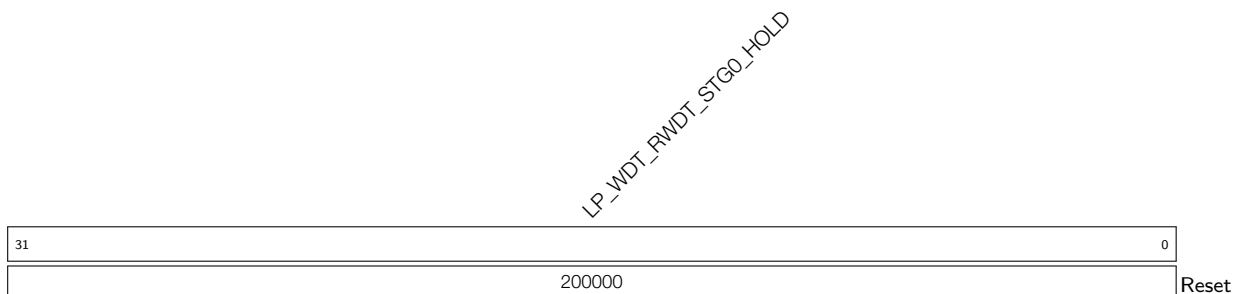
Register 14.2. LP_WDT_RWDT_CONFIG1_REG (0x0004)

LP_WDT_RWDT_STG0_HOLD Configure the timeout time for stage0.

- Measurement unit: LP_DYN_SLOW_CLK
- (R/W)

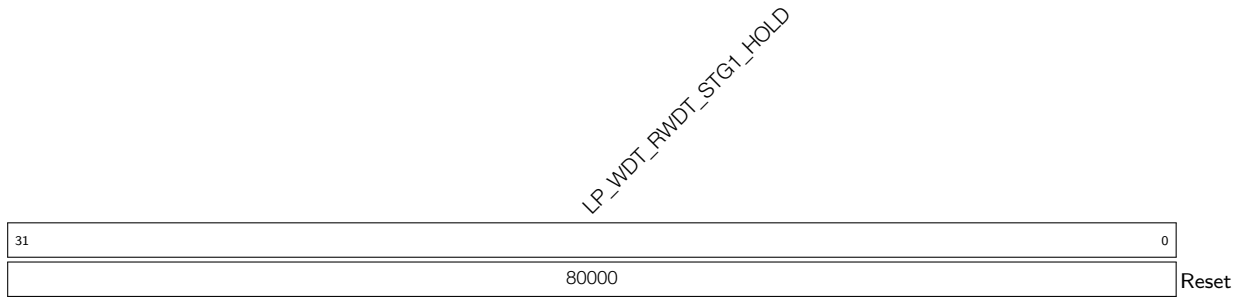
Register 14.3. LP_WDT_RWDT_CONFIG2_REG (0x0008)

LP_WDT_RWDT_STG1_HOLD Configure the timeout time for stage1.

Measurement unit: LP_DYN_SLOW_CLK

(R/W)

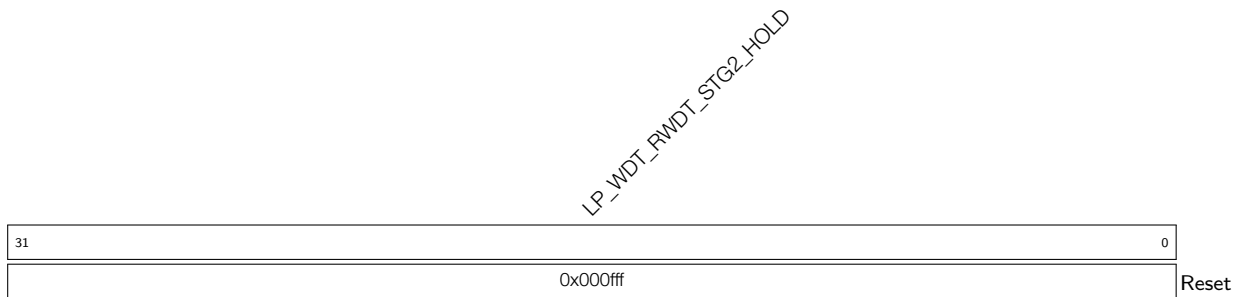
Register 14.4. LP_WDT_RWDT_CONFIG3_REG (0x000C)

LP_WDT_RWDT_STG2_HOLD Configure the timeout time for stage2.

Measurement unit: LP_DYN_SLOW_CLK

(R/W)

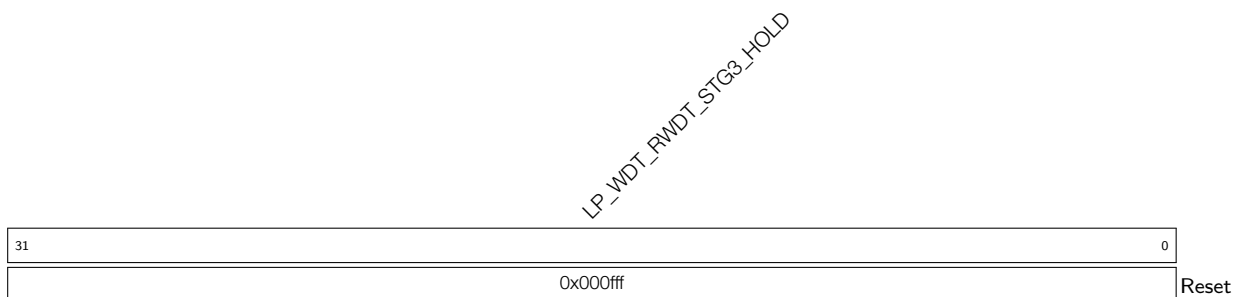
Register 14.5. LP_WDT_RWDT_CONFIG4_REG (0x0010)

LP_WDT_RWDT_STG3_HOLD Configure the timeout time for stage3.

Measurement unit: LP_DYN_SLOW_CLK

(R/W)

Register 14.6. LP_WDT_RWDT_FEED_REG (0x0014)

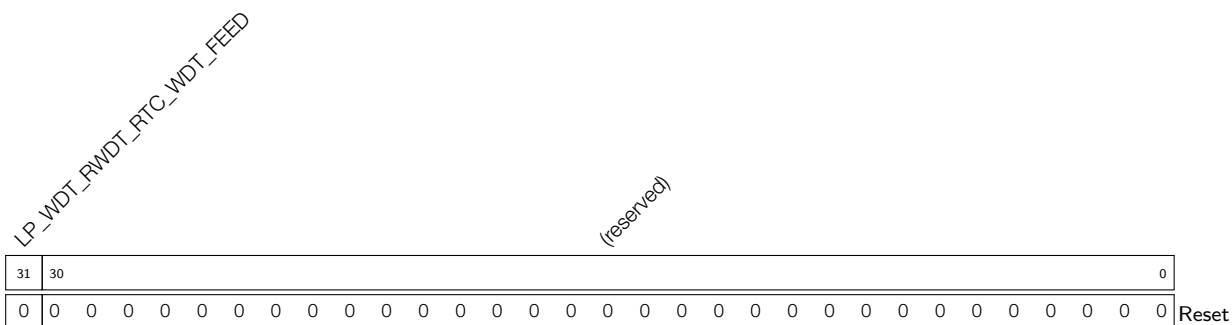

LP_WDT_RWDT_RTC_WDT_FEED Configure this bit to feed the RWDT.

- 0: Invalid
- 1: Feed RWDT (WT)

Register 14.7. LP_WDT_RWDT_WPROTECT_REG (0x0018)

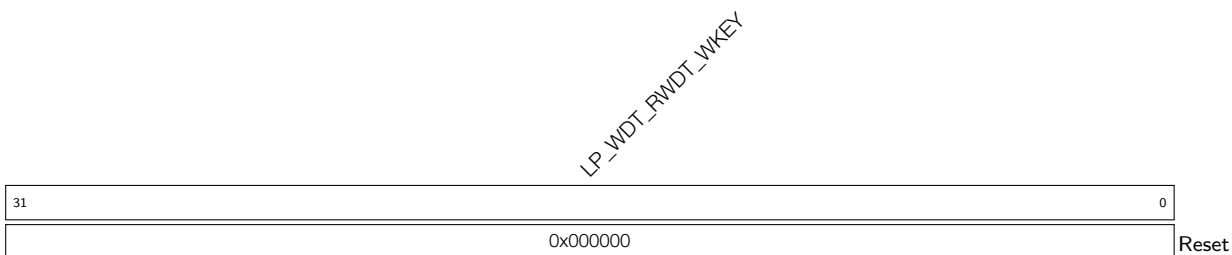

LP_WDT_RWDT_WKEY Configure this field to lock or unlock RWDT's configuration registers.

- 0x50D83AA1: unlock the RWDT configuration register
 - Others value: lock the RWDT configuration register which can't be modified by software.
- (R/W)

Register 14.8. LP_WDT_SWD_CONFIG_REG (0x001C)

LP_WDT_SWD_FEED LP_WDT_SWD_DISABLE		LP_WDT_SWD_SIGNAL_WIDTH				LP_WDT_SWD_RST_FLAG_CLR LP_WDT_SWD_AUTO_FEED_EN				(reserved)				LP_WDT_SWD_RESET_FLAG		
31	30	29				20	19	18	17				1	0		
0	0	300				0	0	0	0	0	0	0	0	0	0	0

LP_WDT_SWD_RESET_FLAG Represents the SWD whether or not generate the reset signal

- 0: No
- 1: Yes
- (RO)

LP_WDT_SWD_AUTO_FEED_EN Configure this bit to enable to feed SWD automatically by hardware.

- 0: Disable
- 1: Enable
- (R/W)

LP_WDT_SWD_RST_FLAG_CLR Configure this bit to clear SWD reset flag

- 0: Invalid
- 1: clear the reset flag
- (WT)

LP_WDT_SWD_SIGNAL_WIDTH Configure the SWD signal length that output to analog circuit.
Measurement unit: LP_DYN_FAST_CLK (R/W)

LP_WDT_SWD_DISABLE Configure this bit to disable the SWD.

- 0: Enable the SWD
- 1: Disable the SWD
- (R/W)

LP_WDT_SWD_FEED Configure this bit to feed the SWD.

- 0: Invalid
- 1: Feed SWD
- (WT)

Register 14.9. LP_WDT_SWD_WPROTECT_REG (0x0020)

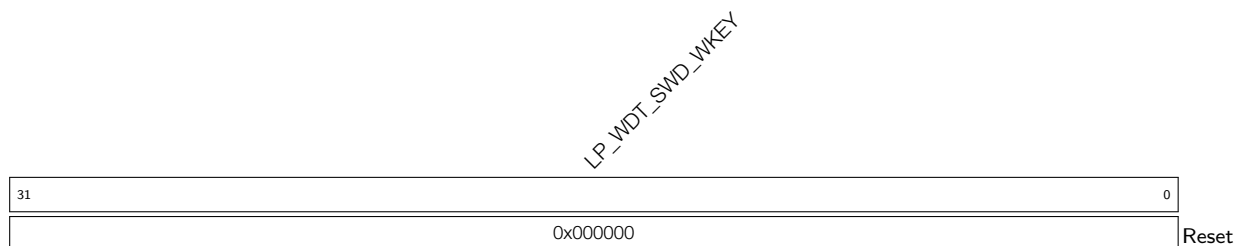

LP_WDT_SWD_WKEY Configure this field to lock or unlock SWD's configuration registers.
 0x50D83AA1: unlock the SWD configuration register.
 Others value: lock the SWD configuration register which can't be modified by the software.
 (R/W)

Register 14.10. LP_WDT_RWDT_INT_RAW_REG (0x0024)

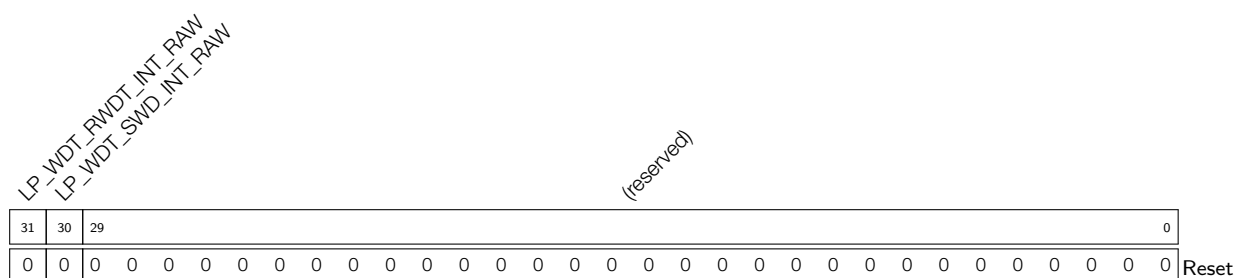

LP_WDT_SWD_INT_RAW Represents the SWD whether or not generates timeout interrupt.
 0: No
 1: Yes
 (R/WTC/SS)

LP_WDT_RWDT_INT_RAW Represents the RWDT whether or not generates timeout interrupt.
 0: No
 1: Yes
 (R/WTC/SS)

Register 14.13. LP_WDT_RWDT_INT_CLR_REG (0x0030)

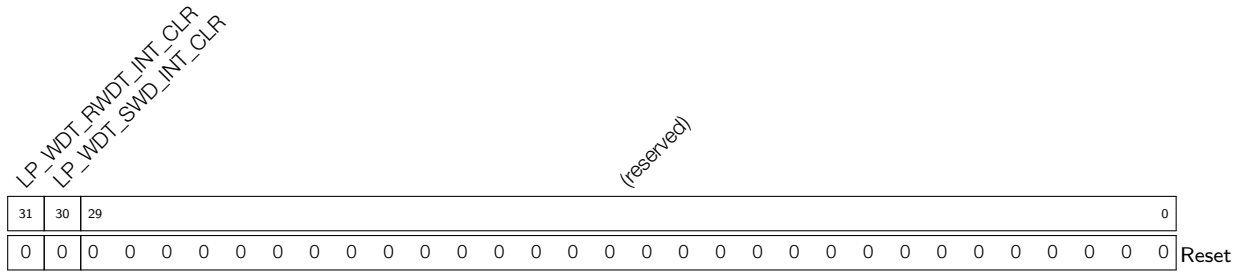

LP_WDT_SWDT_INT_CLR Configure whether to clear the timeout interrupt signal sent by SWD to CPU.
 0: No
 1: Yes
 (WT)

LP_WDT_RWDT_INT_CLR Configure whether to clear the timeout interrupt signal sent by RWDT to CPU.
 0: No
 1: Yes
 (WT)

Register 14.14. LP_WDT_DATE_REG (0x03FC)

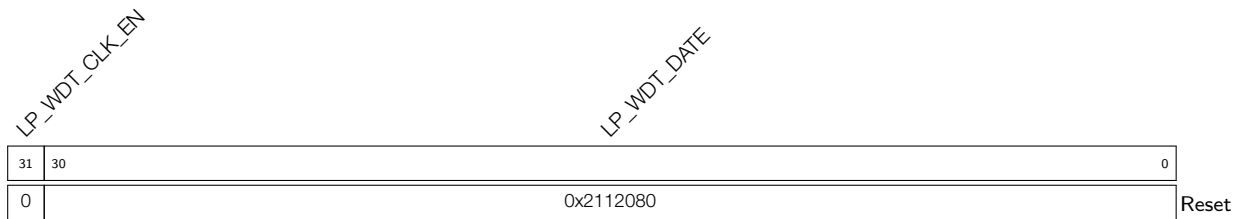

LP_WDT_DATE Version control register (R/W)

LP_WDT_CLK_EN Reserved (R/W)

15 Permission Control (PMS)

15.1 Overview

The permission management of ESP32-C6 can be divided into two parts: PMP (Physical Memory Protection) and APM (Access Permission Management).

The areas managed by PMP and APM are shown in the table 15-1. The first column lists the masters and the first row lists the slaves. For the CPU, the permission management relation between PMP and APM is shown in Figure 15-1.

For example, to access the ROM, the master HP CPU needs the permission from PMP; and to access the LP_MEM, the master HP CPU needs permission from PMP and APM. It is worth noting that HP CPU passes the PMP permission management first and then the APM. If the PMP check fails, the APM permission management will not be triggered.

For HP CPU, PMP manages the access permission of all address spaces, but APM can't manage HP CPU's access to HP_MEM and ROM.

Table 15-1. Management Area of PMP and APM

	ROM	HP_MEM	LP_MEM	CPU_PERI ¹	HP_PERI ²	LP_PERI ³
HP CPU	PMP	PMP	PMP + APM	PMP + APM	PMP + APM	PMP + APM
LP CPU	N/A	APM	APM	N/A	APM	APM
SDIO slave	N/A	APM	APM	APM	APM	APM
Others⁴	N/A	APM	APM	N/A	N/A	N/A

¹ Peripheral registers in the HP CPU, address range: 0x600C_0000 – 0x600C_FFFF

² Peripheral registers in the high-performance system, address range: 0x6000_0000 – 0x600A_FFFF

³ Peripheral registers in the low-power system, address range: 0x600B_0000 – 0x600B_FFFF

⁴ Masters that can request access to the bus, such as GDMA, MEM_MONITOR. For a complete list of masters, please refer to Table 17-5.

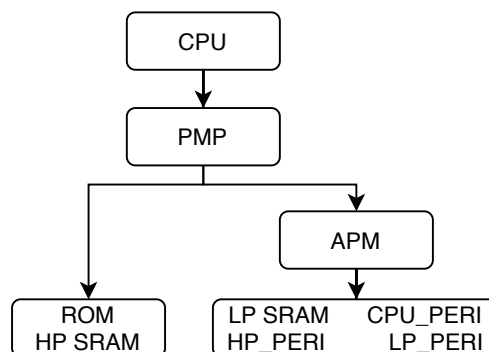

Figure 15-1. PMP-APM Management Relation

PMP related registers are located inside HP CPU and can be read or configured by special instructions. For how to configure PMP, please refer to chapter *High-Performance CPU > Physical Memory Protection*.

APM module contains two parts: TEE (Trusted Execution Environment) controller and APM controller. Each of them contains its own register module: TEE register module and APM register module.

- The TEE controller is responsible for configuring the security mode of a particular master in ESP32-C6 (such as DMA, which can access memory as a master). There are four types of security mode: TEE, REE0 (Rich Execution Environment), REE1, REE2.
- The APM controller is responsible for managing a master's access permissions (read/write/execute) when accessing memory and peripheral registers. By comparing the pre-configured address ranges and corresponding access permissions with the information carried on the bus, such as ID number (please refer to the table 17-5 in Chapter 17 [Debug Assistant \(ASSIST_DEBUG\)](#)), security mode, access address, access permissions, etc, APM determines whether access is allowed.

TEE related registers are used to configure the security mode of each master, and the APM related registers are used to specify the access permission and access address range of each security mode. With TEE controller and APM controller, ESP32-C6 can precisely control the access permission of all masters to memory and peripheral registers.

15.2 Features

ESP32-C6's TEE controller has the following features:

- Four security modes available for the masters
- Security mode configuration for up to 32 masters

ESP32-C6's APM controller has the following features:

- Access permission configuration for up to 16 address ranges
- Access management to internal and external memory and peripheral registers
- Interrupt function
- Exception information record

15.3 Functional Description

15.3.1 TEE Controller Functional Description

ESP32-C6 provides four kinds of security mode: TEE, REE0, REE1, and REE2.

For the HP CPU to access memory or peripheral registers, first select the machine mode or user mode of the HP CPU, then configure its security mode. For the configuration of machine mode and user mode, please refer to RISC-V Instruction Set Manual, Volume II: Privileged Architecture, Version 1.10.

- When the HP CPU is in machine mode, its security mode is TEE mode.
- When the HP CPU is in user mode, its security mode is REE mode. To specify REE0, REE1 or REE2 mode, [TEE_M0_MODE](#) of [TEE_M0_MODE_CTRL_REG](#) should be configured:
 - If set [TEE_M0_MODE](#) to 0, which is in TEE mode its security mode is REE0
 - if set [TEE_M0_MODE](#) to 1,2 or 3, which is in REE mode, its security mode is REE0, REE1 and REE2 respectively.

For the LP CPU's access to memories or peripheral registers, security mode can be set by configuring the [LP_TEE_M0_MODE](#) of [LP_TEE_M0_MODE_CTRL_REG](#) register.

As for other masters, security mode can be set by configuring the `TEE_Mn_MODE` of TEE registers. n here equals to the ID number of master in table 17-5.

15.3.2 APM Controller Functional Description

15.3.2.1 Architecture

There are 3 register modules for APM registers:

- High Performance APM Registers (HP_APM_REG)
- Low Power APM0 Registers (LP_APM0_REG)
- Low Power APM Registers (LP_APM_REG)

Figure 15-2 shows the access path managed by the APM controller.

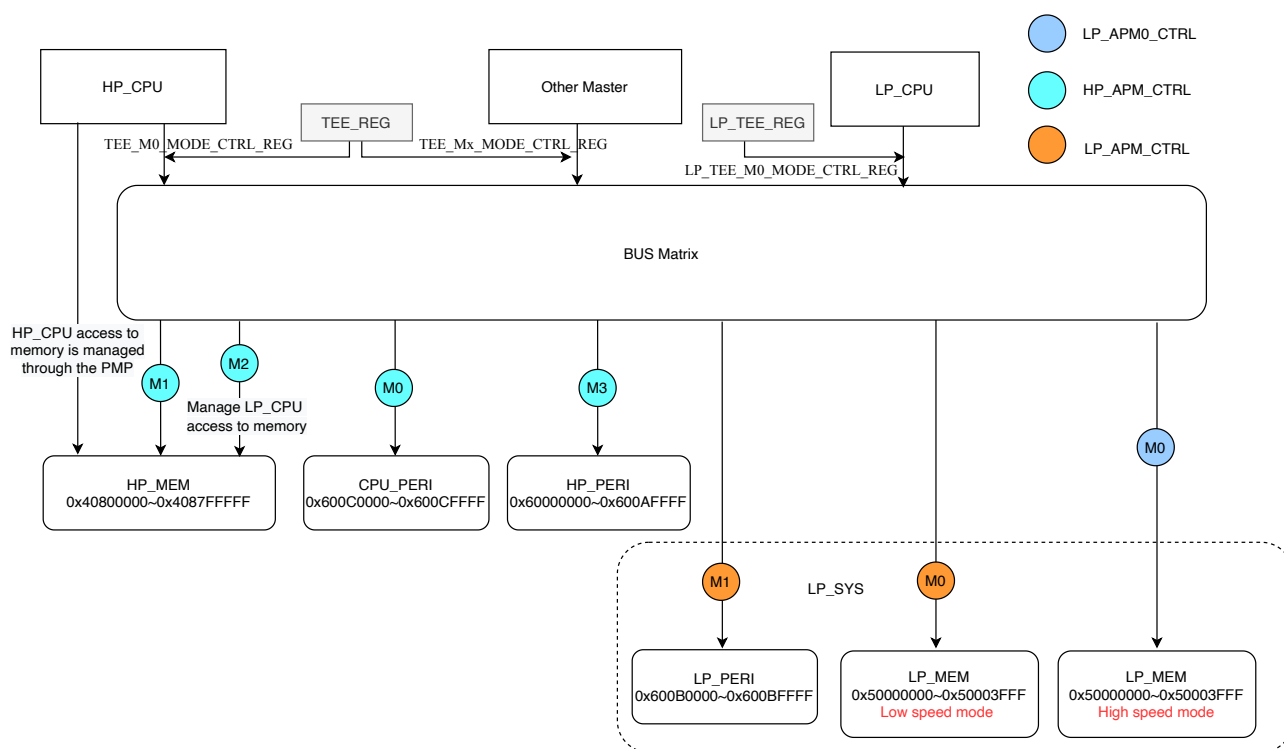

Figure 15-2. APM Controller Structure

Note:

For the difference between Low speed mode and High speed mode in the figure, please refer to [System and Memory](#).

As shown in the Figure 15-2, APM controller contains 3 functional modules: HP_APM_CTRL, LP_APM0_CTRL, and LP_APM_CTRL, configured by the register modules HP_APM_REG, LP_APM0_REG, and LP_APM_REG respectively.

- HP_APM_CTRL manages 4 access paths, namely M0-M3 in the figure 15-2. Permission management of each path can be enabled by configuring HP_APM_FUNC_CTRL_REG (enabled by default).
- LP_APM0_CTRL manages one access path, namely M0 in the figure 15-2. Permission management of this path can be enabled by configuring LP_APM0_FUNC_CTRL_REG (enabled by default).

- LP_APM_CTRL manages 2 access paths, namely M0 and M1 in the figure 15-2. Permission management of each path can be enabled by configuring LP_APM_FUNC_CTRL_REG (enabled by default).

The table 15-2 below shows the detailed information of each functional module:

Table 15-2. Configuring Access Path

Register Modules	Functional Modules	Access Path No.	Enable Permission Management	Configurable Address Ranges No.	Enable Address Ranges
HP_APM_REG	HP_APM_CTRL	4	HP_APM_FUNC_CTRL_REG	16	HP_APM_REGION_FILTER_EN_REG
LP_APM0_REG	LP_APM0_CTRL	1	LP_APM0_FUNC_CTRL_REG	4	LP_APM0_REGION_FILTER_EN_REG
LP_APM_REG	LP_APM_CTRL	2	LP_APM_FUNC_CTRL_REG	4	LP_APM_REGION_FILTER_EN_REG

15.3.2.2 Address Ranges

- HP_APM_REG register module can configure up to 16 groups of address ranges for functional module HP_APM_CTRL. The start and end address for each region (address range) can be configured by setting HP_APM_REGION n _ADDR_START and HP_APM_REGION n _ADDR_END respectively. Configure the bit n of HP_APM_REGION_FILTER_EN_REG to enable region n . The first group of address ranges is enabled by default.
- LP_APM0_REG register module can configure up to 4 groups of address ranges for functional module LP_APM0_CTRL. The start and end address for each region can be configured by setting LP_APM0_REGION n _ADDR_START and LP_APM0_REGION n _ADDR_END. Configure the bit n of LP_APM0_REGION_FILTER_EN_REG to enable region n . The first group of address ranges is enabled by default.
- LP_APM_REG register module can configure up to 4 groups of address ranges for functional module LP_APM_CTRL. The start and end address for region n can be configured by setting LP_APM_REGION n _ADDR_START and LP_APM_REGION n _ADDR_END. Configure the bit n of LP_APM_REGION_FILTER_EN_REG to enable region n . The first group of address ranges is enabled by default.

When configuring the address ranges, the address requires 4-byte alignment (the lower two bits of the address are 0). For example, the address range could be set as 0x4080000C ~ 0x40808774 or 0x600C0008 ~ 0x600CFF70.

15.3.2.3 Access Permissions of Address Ranges

Within each address range, access permissions (read/write/execute) can be configured for different security modes:

- The master in TEE mode always has read, write, and execute permissions in the address range.
- For master in REE0, REE1 or REE2 mode, access permissions can be configured in HP_APM_REGION n _ATTR_REG, LP_APM_REGION n _ATTR_REG or LP_APM0_REGION n _ATTR_REG based on the access path.

Different access paths managed by the same register module share the configuration of address ranges and access permissions. For example, the permission management of data path HP_APM M0-M3 shown in figure 15-2 should follow the address ranges and access permissions of each address range configured in the register module `HP_APM_REG`. Likewise, the permission management of data path LP_APM M0-M1 shown in figure 15-2 should follow the address ranges and access permissions of each address range configured in the register module `LP_APM_REG`.

For the access path HP_APM M1, all masters except HP CPU and LP CPU access HP_MEM through this data access path. Suppose that `HP_APM_M1_FUNC_EN` is enabled and a master in REE1 mode needs to access HP_MEM through HP_APM M1. The whole process is as follows:

1. HP_APM M1 will first determine whether the address requested to access is within the 16 address ranges configured in the `HP_APM_REG` register module. If 16 groups of address ranges are partially enabled, HP_APM M1 will only determine whether the address requested to access is within the enabled address ranges.
2. Assuming that the address requested to access is within second group of configured address ranges, then determine whether the address range of this group is enabled, that is, whether bit 1 of `HP_APM_REGION_FILTER_EN` is 1.
3. If the address range is enabled, judge whether the master has read permission for the second group of address ranges in REE1 mode, that is, whether `HP_APM_REGION1_R1_R` in `HP_APM_REGION1_ATTR_REG` is valid (that is, 1). If valid, the read request will be allowed. Otherwise it will return 0.

When the HP power domain (see chapter *Low-Power Management [to be added later]*) powered down and restarted, the LP CPU does not have access to HP_MEM by default. The master must be in the TEE mode to configure `LP_TEE_FORCE_ACC_HPMEM_EN` in the LP power domain. When `LP_TEE_FORCE_ACC_HPMEM_EN` is enabled, the LP CPU can access the HP_MEM without the permission management of APM controller.

The address ranges configured above may overlap. For example, region 1 and region 2 overlap. If region 1 is set to be unreadable and region 2 is set to be readable, in this case the overlapping area of region 1 and region 2 is readable. The same rules apply for write and execute permissions.

Note:

- When powered up, only the HP CPU is in TEE mode by default, and the other masters are in REE2 mode. By default, APM controller blocks access requests from all master in REE0, REE1, and REE2 modes.
- All registers listed in 15.6 *Register Summary* can only be configured by the master in TEE security mode.

15.4 Programming Procedure

- Configure the HP CPU to machine mode (ie. TEE mode).
- Choose the security mode of the master by configuring `TEE_MnMODE` or `LP_TEE_MnMODE`. *n* here equals to the master ID in Table 17-5.
- Configure the start and end address for access address ranges by setting `HP_APM_REGIONnADDR_START`, `HP_APM_REGIONnADDR_END`, or

[LP_APM0_REGION \$n\$ _ADDR_START](#), [LP_APM0_REGION \$n\$ _ADDR_END](#), or
[LP_APM_REGION \$n\$ _ADDR_START](#), [LP_APM_REGION \$n\$ _ADDR_END](#).

- Configure the access permissions of each region in different security mode by configuring [HP_APM_REGION \$n\$ _ATTR_REG](#) or [LP_APM_REGION \$n\$ _ATTR_REG](#) or [LP_APM0_REGION \$n\$ _ATTR_REG](#).
- Set the bit n of [HP_APM_REGION_FILTER_EN_REG](#) or [LP_APM_REGION_FILTER_EN_REG](#) or [LP_APM0_REGION_FILTER_EN_REG](#) to enable region n .
- Configure [HP_APM_FUNC_CTRL_REG](#) [LP_APM_FUNC_CTRL_REG](#) or [LP_APM0_FUNC_CTRL_REG](#) enable permission management of different access paths (enabled by default).

Take I2S accessing HP_MEM via GDMA as an example, assuming that it is only allowed to read and write in the fourth group address range 0x40805000 ~ 0x4080F000 address range:

- Configure the HP CPU to machine mode (ie. TEE mode).
- According to the ID number in the table 17-5, set the [TEE_M19_MODE](#) to be 1, so as to set the security mode for I2S access via GDMA to REE0 mode.
- Configure the start address to 0x40805000 and end address to 0x4080F000 for the access address range by configuring [HP_APM_REGION3_ADDR_START](#) and [HP_APM_REGION3_ADDR_END](#) respectively.
- Set [HP_APM_REGION3_R0_W](#) and [HP_APM_REGION3_R0_R](#) to 1.
- Set the bit 3 of [HP_APM_REGION_FILTER_EN](#) to 1.
- Set [HP_APM_M1_FUNC_EN](#) to 1.

Through the above configuration, I2S can read and write in the address range of 0x40805000 ~ 0x4080F000 in HP_MEM via GDMA.

15.5 Illegal access and interrupts

If the information carried on the bus is inconsistent with the configuration, ESP32-C6 will regard it as an illegal access and proceed as follows:

- Deny the access request and return the default value:
 - Returns 0 on instruction execution and read
 - Invalidate the write operation
- Trigger interrupt

The APM controller module will automatically record relevant information about illegal access, including master ID, security mode, access address, reason for illegal access (address out of bounds or permission restrictions), and permission management result of each access path. All these information can be obtained from relevant registers listed in the section 15.6 *Register Summary*.

Take the access path HP_APM M0 as an example. When illegal access occurs:

- [HP_APM_M0_EXCEPTION_ID](#) records the master ID.
- [HP_APM_M0_EXCEPTION_MODE](#) records the security mode.
- [HP_APM_M0_EXCEPTION_ADDR](#) records the access address.
- [HP_APM_M0_EXCEPTION_STATUS](#) records the reason for illegal access.

- If the address requested to access is not among the enabled region of the 16 address ranges configured by `HP_APM_REGION n _ADDR_START`, `HP_APM_REGION n _ADDR_END` and `HP_APM_REGION_FILTER_EN`, bit1 of `HP_APM_M0_EXCEPTION_STATUS` will be set to 1, indicating address out of bounds.
- If the address requested to access is among the enabled region/regions of the 16 address ranges but the master doesn't have the read/write/execute permission within this region/regions, then the bit0 will be set to 1, indicating permission restrictions.
- `HP_APM_M0_EXCEPTION_REGION` records the permission management result of each address range. This register has a total of 16 bits, corresponding to 16 groups of address ranges, and bit0 corresponds to the first group of address ranges. When the address to access is within a particular enabled address range, but the master doesn't have the corresponding read/write/execute permission within this address range, the corresponding bit of this register will be set to 1.

ESP32-C6's APM controller can generate seven interrupt signals, which will be sent to *Interrupt Matrix (INTMTX)*:

- `HP_APM_M0_INTR`
- `HP_APM_M1_INTR`
- `HP_APM_M2_INTR`
- `HP_APM_M3_INTR`
- `LP_APM_M0_INTR`
- `LP_APM_M1_INTR`
- `LP_APM0_M0_INTR`

These seven interrupt signals correspond to the controlled access paths shown in Figure 15-2. If an illegal access occurs in a controlled access path, the corresponding interrupt will be generated.

15.6 Register Summary

15.6.1 High Performance APM Registers (HP_APM_REG)

The addresses in this section are relative to the Access Permission Management Controller (HP_APM) base address provided in Table 5-2 in Chapter 5 *System and Memory*.

The abbreviations given in Column **Access** are explained in Section *Access Types for Registers*.

Name	Description	Address	Access
Region filter enable register			
<code>HP_APM_REGION_FILTER_EN_REG</code>	Region filter enable register	0x0000	R/W
Region address register			
<code>HP_APM_REGIONn_ADDR_START_REG</code> (n : 0-15)	Region address register	0x0004+0xC* n	R/W
<code>HP_APM_REGIONn_ADDR_END_REG</code> (n : 0-15)	Region address register	0x0008+0xC* n	R/W
Region access authority attribute register			

Name	Description	Address	Access
HP_APM_REGION n _ATTR_REG (n : 0-15)	Region access authority attribute register	0x000C+0xC* n	R/W
function control register			
HP_APM_FUNC_CTRL_REG	APM function control register	0x00C4	R/W
M0 status register			
HP_APM_M0_STATUS_REG	M0 status register	0x00C8	RO
M0 status clear register			
HP_APM_M0_STATUS_CLR_REG	M0 status clear register	0x00CC	WT
M0 exception_info0 register			
HP_APM_M0_EXCEPTION_INFO0_REG	M0 exception_info0 register	0x00D0	RO
M0 exception_info1 register			
HP_APM_M0_EXCEPTION_INFO1_REG	M0 exception_info1 register	0x00D4	RO
M1 status register			
HP_APM_M1_STATUS_REG	M1 status register	0x00D8	RO
M1 status clear register			
HP_APM_M1_STATUS_CLR_REG	M1 status clear register	0x00DC	WT
M1 exception_info0 register			
HP_APM_M1_EXCEPTION_INFO0_REG	M1 exception_info0 register	0x00E0	RO
M1 exception_info1 register			
HP_APM_M1_EXCEPTION_INFO1_REG	M1 exception_info1 register	0x00E4	RO
M2 status register			
HP_APM_M2_STATUS_REG	M2 status register	0x00E8	RO
M2 status clear register			
HP_APM_M2_STATUS_CLR_REG	M2 status clear register	0x00EC	WT
M2 exception_info0 register			
HP_APM_M2_EXCEPTION_INFO0_REG	M2 exception_info0 register	0x00F0	RO
M2 exception_info1 register			
HP_APM_M2_EXCEPTION_INFO1_REG	M2 exception_info1 register	0x00F4	RO
M3 status register			
HP_APM_M3_STATUS_REG	M3 status register	0x00F8	RO
M3 status clear register			
HP_APM_M3_STATUS_CLR_REG	M3 status clear register	0x00FC	WT
M3 exception_info0 register			
HP_APM_M3_EXCEPTION_INFO0_REG	M3 exception_info0 register	0x0100	RO
M3 exception_info1 register			
HP_APM_M3_EXCEPTION_INFO1_REG	M3 exception_info1 register	0x0104	RO
APM interrupt enable register			
HP_APM_INT_EN_REG	APM interrupt enable register	0x0108	R/W
Clock gating register			
HP_APM_CLOCK_GATE_REG	Clock gating register	0x010C	R/W
Version control register			
HP_APM_DATE_REG	Version control register	0x07FC	R/W

15.6.2 Low Power APM Registers (LP_APM_REG)

The addresses in this section are relative to the Low-Power Access Permission Management (LP_APM) base address provided in Table 5-2 in Chapter 5 *System and Memory*.

The abbreviations given in Column **Access** are explained in Section *Access Types for Registers*.

Name	Description	Address	Access
Region filter enable register			
LP_APM_REGION_FILTER_EN_REG	Region filter enable register	0x0000	R/W
Region address register			
LP_APM_REGION n _ADDR_START_REG (n : 0-3)	Region address register	0x0004+0xC* n	R/W
LP_APM_REGION n _ADDR_END_REG (n : 0-3)	Region address register	0x0008+0xC* n	R/W
Region access authority attribute register			
LP_APM_REGION n _ATTR_REG (n : 0-3)	Region access authority attribute register	0x000C+0xC* n	R/W
function control register			
LP_APM_FUNC_CTRL_REG	APM function control register	0x00C4	R/W
M0 status register			
LP_APM_M0_STATUS_REG	M0 status register	0x00C8	RO
M0 status clear register			
LP_APM_M0_STATUS_CLR_REG	M0 status clear register	0x00CC	WT
M0 exception_info0 register			
LP_APM_M0_EXCEPTION_INFO0_REG	M0 exception_info0 register	0x00D0	RO
M0 exception_info1 register			
LP_APM_M0_EXCEPTION_INFO1_REG	M0 exception_info1 register	0x00D4	RO
M1 status register			
LP_APM_M1_STATUS_REG	M1 status register	0x00D8	RO
M1 status clear register			
LP_APM_M1_STATUS_CLR_REG	M1 status clear register	0x00DC	WT
M1 exception_info0 register			
LP_APM_M1_EXCEPTION_INFO0_REG	M1 exception_info0 register	0x00E0	RO
M1 exception_info1 register			
LP_APM_M1_EXCEPTION_INFO1_REG	M1 exception_info1 register	0x00E4	RO
APM interrupt enable register			
LP_APM_INT_EN_REG	APM interrupt enable register	0x00E8	R/W
clock gating register			
LP_APM_CLOCK_GATE_REG	clock gating register	0x00EC	R/W
Version control register			
LP_APM_DATE_REG	Version control register	0x00FC	R/W

15.6.3 Low Power APM0 Registers (LP_APM0_REG)

The addresses in this section are relative to the Access Permission Management Controller (HP_APM) base address + 0x1000 provided in Table 5-2 in Chapter 5 *System and Memory*.

The abbreviations given in Column **Access** are explained in Section [Access Types for Registers](#).

Name	Description	Address	Access
Region filter enable register			
LP_APM0_REGION_FILTER_EN_REG	Region filter enable register	0x0000	R/W
Region address register			
LP_APM0_REGIONn_ADDR_START_REG (n : 0-3)	Region address register	0x0004+0xC* n	R/W
LP_APM0_REGIONn_ADDR_END_REG (n : 0-3)	Region address register	0x0008+0xC* n	R/W
Region access authority attribute register			
LP_APM0_REGIONn_ATTR_REG (n : 0-3)	Region access authority attribute register	0x000C+0xC* n	R/W
APM function control register			
LP_APM0_FUNC_CTRL_REG	APM function control register	0x00C4	R/W
M0 status register			
LP_APM0_M0_STATUS_REG	M0 status register	0x00C8	RO
M0 status clear register			
LP_APM0_M0_STATUS_CLR_REG	M0 status clear register	0x00CC	WT
M0 exception_info0 register			
LP_APM0_M0_EXCEPTION_INFO0_REG	M0 exception_info0 register	0x00D0	RO
M0 exception_info1 register			
LP_APM0_M0_EXCEPTION_INFO1_REG	M0 exception_info1 register	0x00D4	RO
APM interrupt enable register			
LP_APM0_INT_EN_REG	APM interrupt enable register	0x00D8	R/W
Clock gating register			
LP_APM0_CLOCK_GATE_REG	Clock gating register	0x00DC	R/W
Version control register			
LP_APM0_DATE_REG	Version control register	0x07FC	R/W

15.6.4 High Performance TEE Registers

The addresses in this section are relative to the Trusted Execution Environment (TEE) Register provided in Table 5-2 in Chapter 5 [System and Memory](#).

The abbreviations given in Column **Access** are explained in Section [Access Types for Registers](#).

Name	Description	Address	Access
Tee mode control register			
TEE_Mn_MODE_CTRL_REG (n : 0-31)	TEE mode control register	0x0000+0x4* n	R/W
clock gating register			
TEE_CLOCK_GATE_REG	Clock gating register	0x0080	R/W
Version control register			
TEE_DATE_REG	Version control register	0x0FFC	R/W

15.6.5 Low Power TEE Registers

The addresses in this section are relative to the Low-power Trusted Execution Environment (LP_TEE) provided in Table 5-2 in Chapter 5 *System and Memory*.

The abbreviations given in Column **Access** are explained in Section *Access Types for Registers*.

Name	Description	Address	Access
Tee mode control register			
LP_TEE_M0_MODE_CTRL_REG	TEE mode control register	0x0000	R/W
clock gating register			
LP_TEE_CLOCK_GATE_REG	Clock gating register	0x0004	R/W
configure_register			
LP_TEE_FORCE_ACC_HP_REG	Force access to hpmem configuration register	0x0090	R/W
Version control register			
LP_TEE_DATE_REG	Version control register	0x00FC	R/W

15.7 Registers

15.7.1 High Performance APM Registers (HP_APM_REG)

Register 15.1. HP_APM_REGION_FILTER_EN_REG (0x0000)

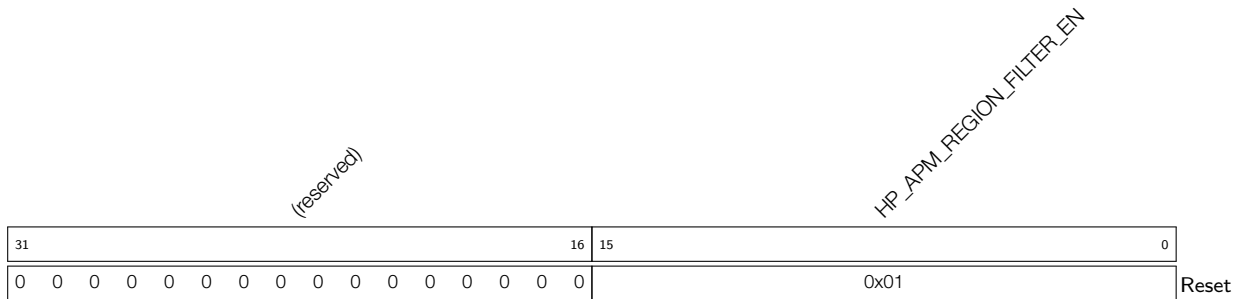

HP_APM_REGION_FILTER_EN Configure bit n (0-15) to enable region n .

0: disable

1: enable

(R/W)

Register 15.2. HP_APM_REGION n _ADDR_START_REG (n : 0-15) (0x0004+0xC* n)

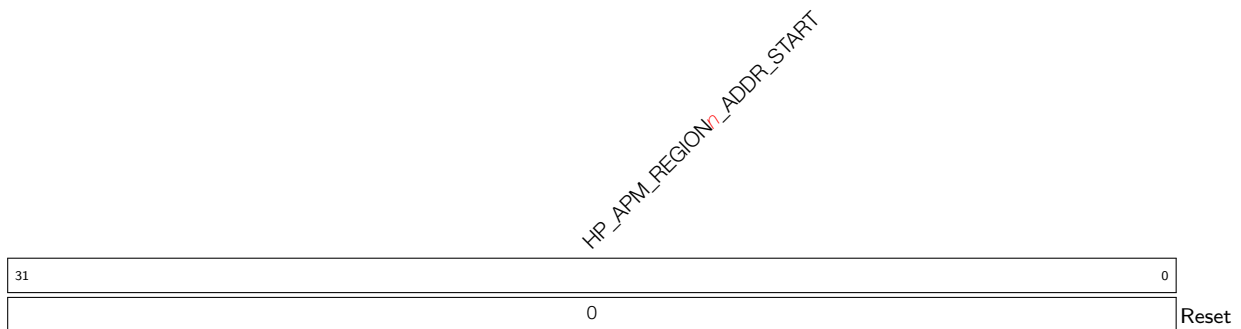

HP_APM_REGION n _ADDR_START Configures start address of region n . (R/W)

Register 15.3. HP_APM_REGION n _ADDR_END_REG (n : 0-15) (0x0008+0xC* n)

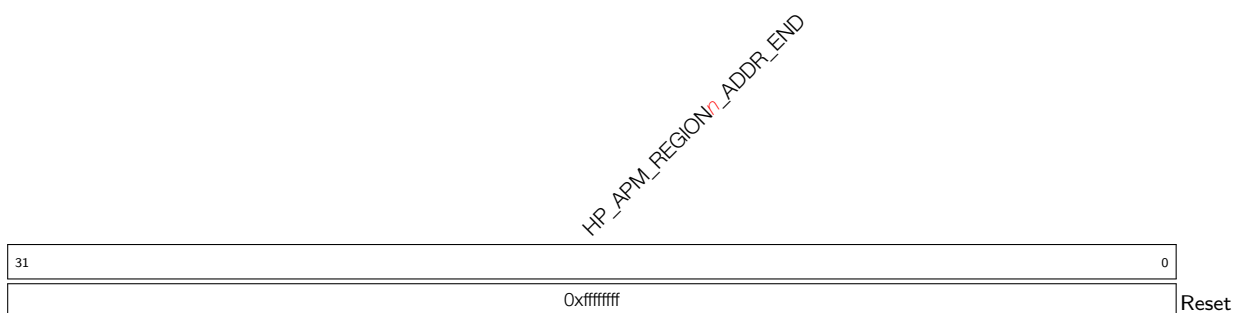

HP_APM_REGION n _ADDR_END Configures end address of region n . (R/W)

Register 15.6. HP_APM_M0_STATUS_REG (0x00C8)

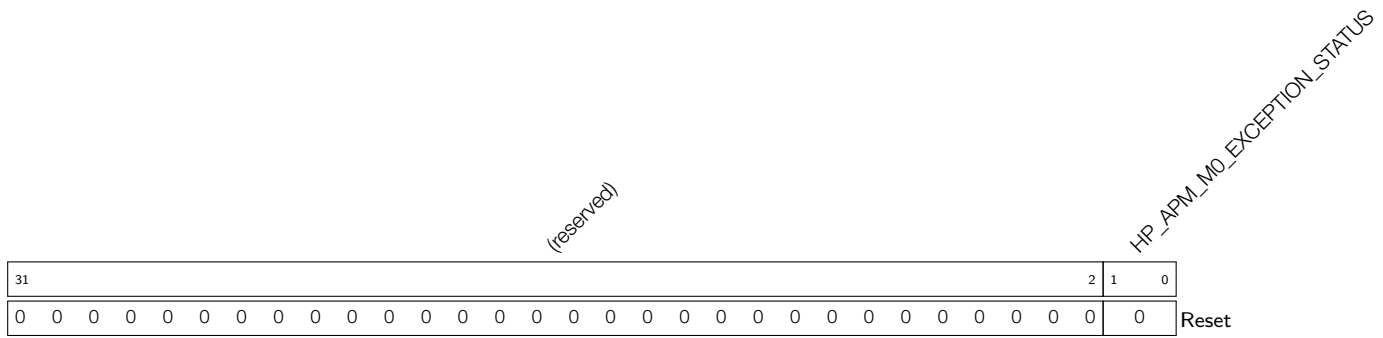

HP_APM_M0_EXCEPTION_STATUS Represents exception status.

bit0: 1 represents authority_exception

bit1: 1 represents space_exception

(RO)

Register 15.7. HP_APM_M0_STATUS_CLR_REG (0x00CC)

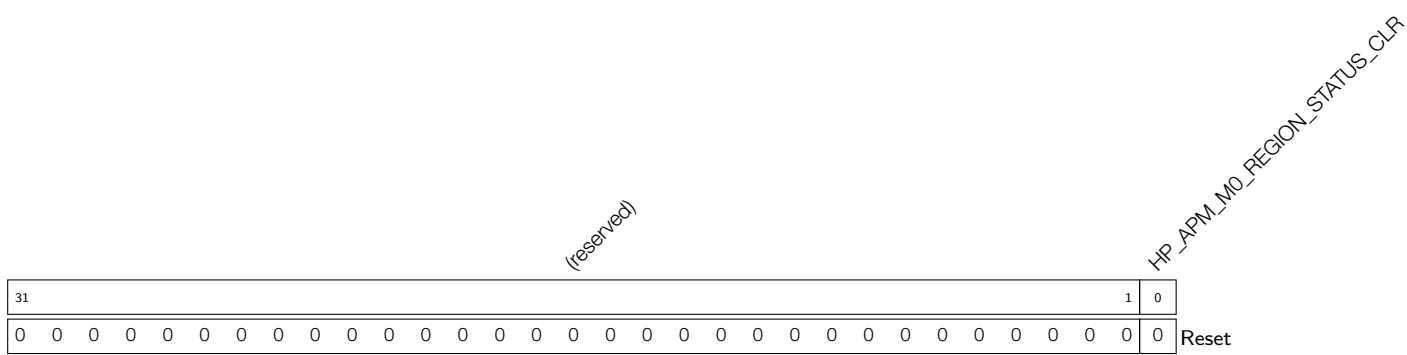

HP_APM_M0_REGION_STATUS_CLR Configures to clear exception status. (WT)

Register 15.8. HP_APM_M0_EXCEPTION_INFO0_REG (0x00D0)

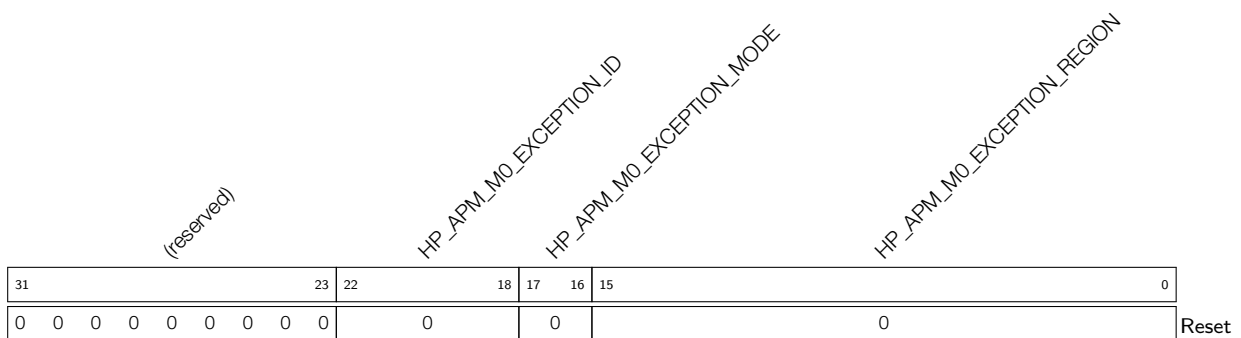

HP_APM_M0_EXCEPTION_REGION Represents exception region. (RO)

HP_APM_M0_EXCEPTION_MODE Represents exception mode. (RO)

HP_APM_M0_EXCEPTION_ID Represents exception id information. (RO)

Register 15.9. HP_APM_M0_EXCEPTION_INFO1_REG (0x00D4)

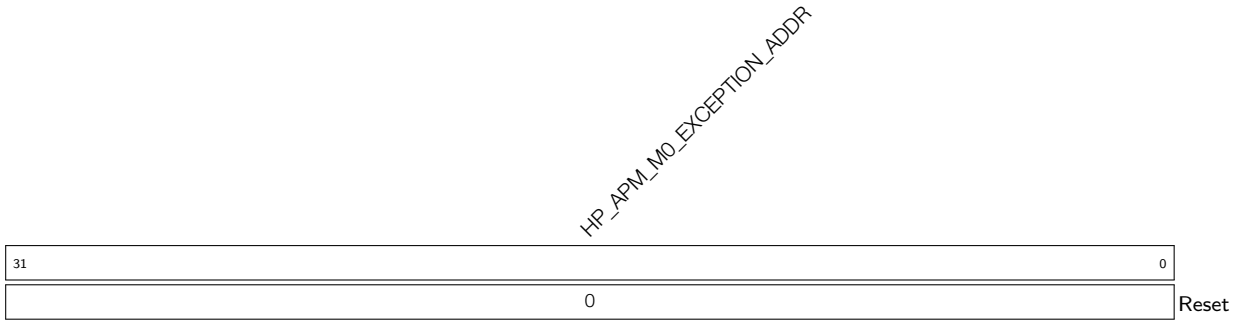

HP_APM_M0_EXCEPTION_ADDR Represents exception addr. (RO)

Register 15.10. HP_APM_M1_STATUS_REG (0x00D8)

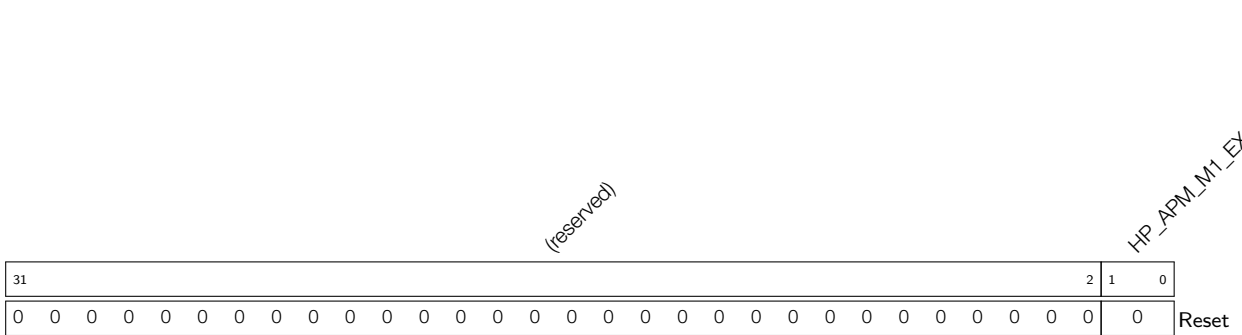

HP_APM_M1_EXCEPTION_STATUS Represents exception status.

bit0: 1 represents authority_exception

bit1: 1 represents space_exception

(RO)

Register 15.11. HP_APM_M1_STATUS_CLR_REG (0x00DC)

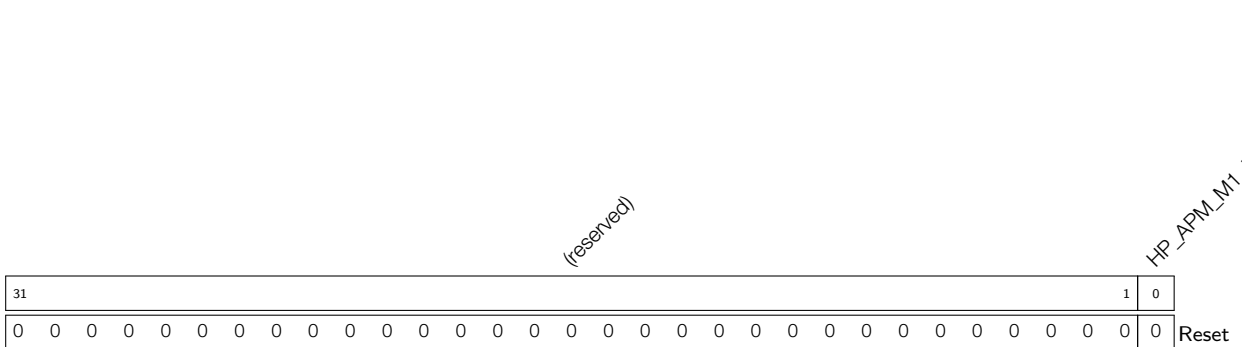

HP_APM_M1_REGION_STATUS_CLR Configures to clear exception status. (WT)

Register 15.12. HP_APM_M1_EXCEPTION_INFO0_REG (0x00E0)

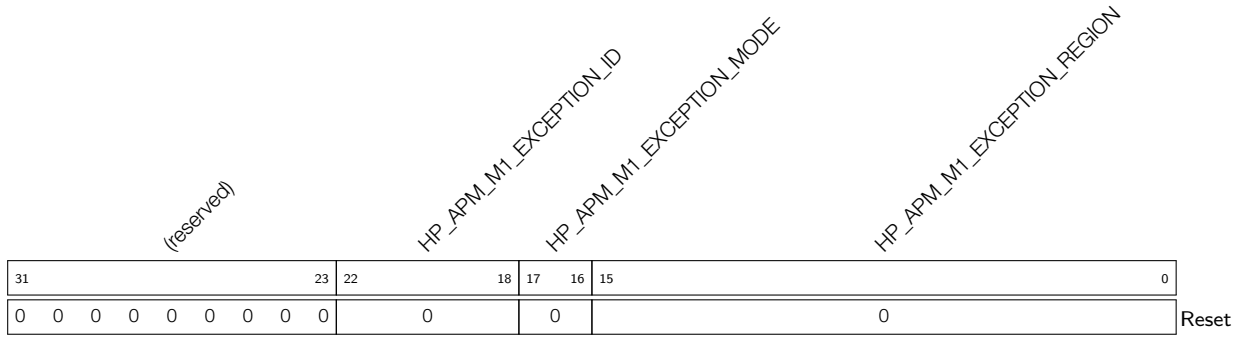

HP_APM_M1_EXCEPTION_REGION Represents exception region. (RO)

HP_APM_M1_EXCEPTION_MODE Represents exception mode. (RO)

HP_APM_M1_EXCEPTION_ID Represents exception id information. (RO)

Register 15.13. HP_APM_M1_EXCEPTION_INFO1_REG (0x00E4)

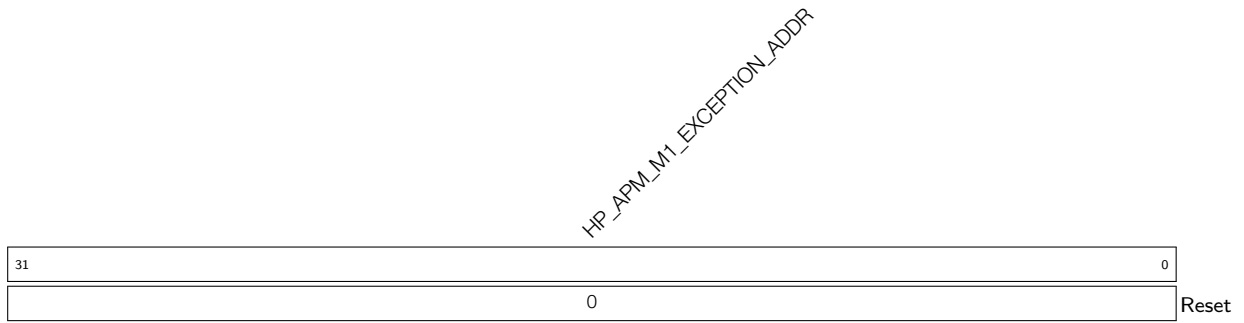

HP_APM_M1_EXCEPTION_ADDR Represents exception addr. (RO)

Register 15.14. HP_APM_M2_STATUS_REG (0x00E8)

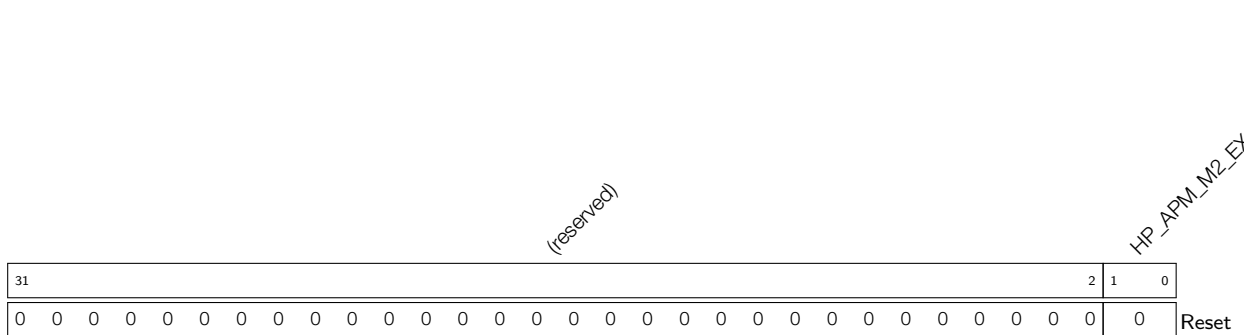

HP_APM_M2_EXCEPTION_STATUS Represents exception status.

bit0: 1 represents authority_exception

bit1: 1 represents space_exception

(RO)

Register 15.15. HP_APM_M2_STATUS_CLR_REG (0x00EC)

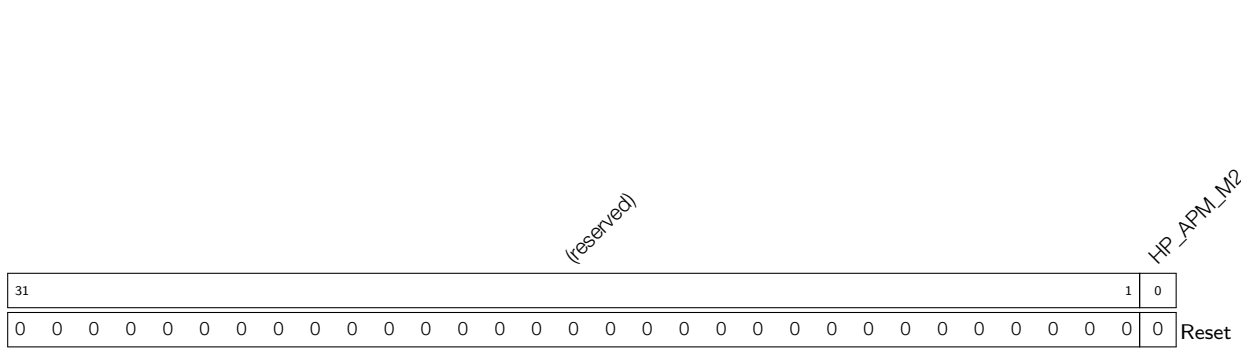

HP_APM_M2_REGION_STATUS_CLR Configures to clear exception status. (WT)

Register 15.16. HP_APM_M2_EXCEPTION_INFO0_REG (0x00F0)

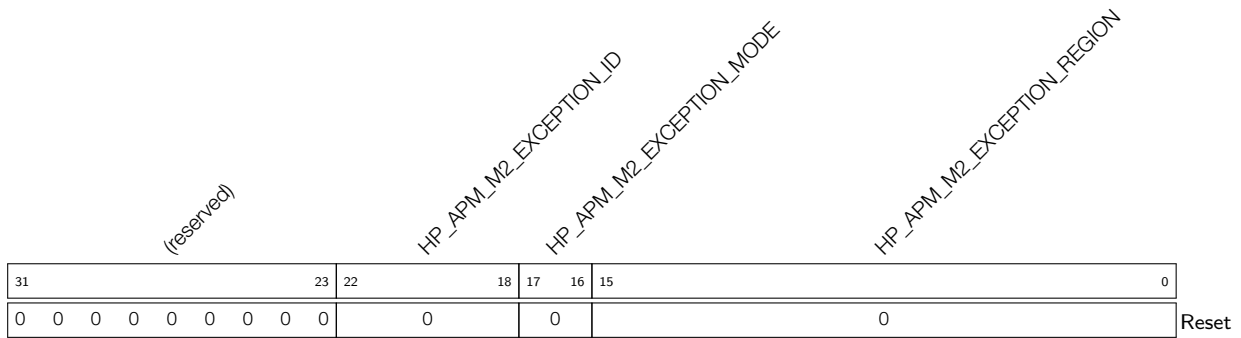

HP_APM_M2_EXCEPTION_REGION Represents exception region. (RO)

HP_APM_M2_EXCEPTION_MODE Represents exception mode. (RO)

HP_APM_M2_EXCEPTION_ID Represents exception id information. (RO)

Register 15.17. HP_APM_M2_EXCEPTION_INFO1_REG (0x00F4)

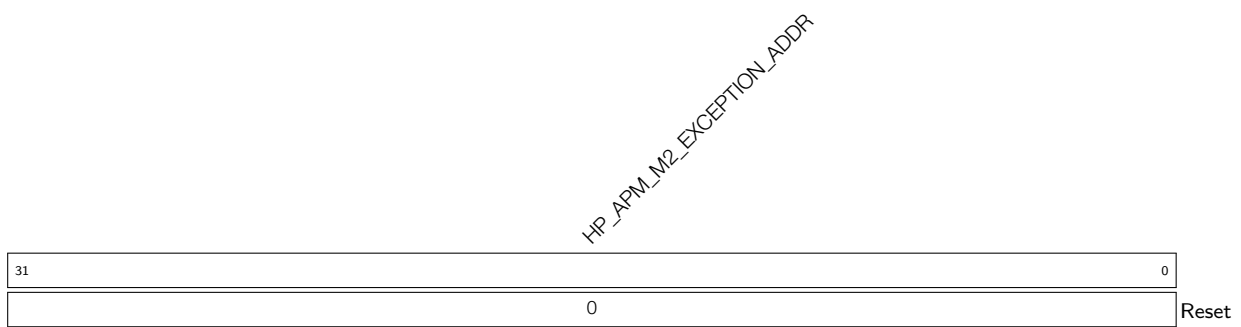

HP_APM_M2_EXCEPTION_ADDR Represents exception addr. (RO)

Register 15.21. HP_APM_M3_EXCEPTION_INFO1_REG (0x0104)

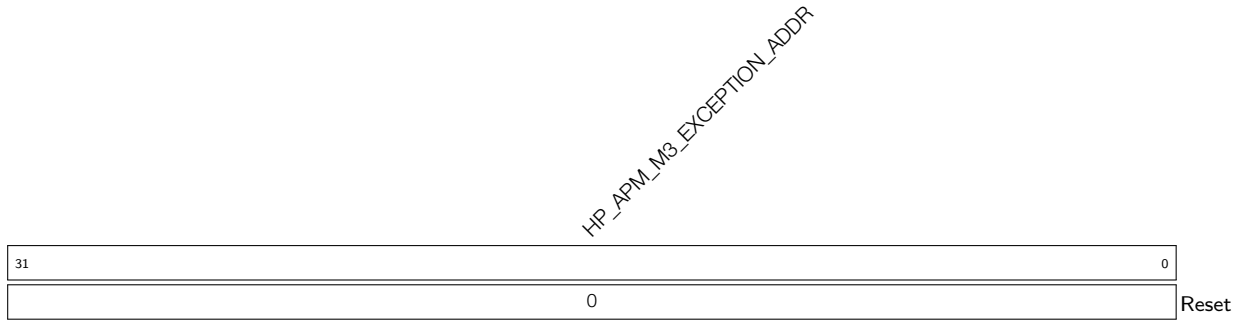

HP_APM_M3_EXCEPTION_ADDR Represents exception addr. (RO)

Register 15.22. HP_APM_INT_EN_REG (0x0108)

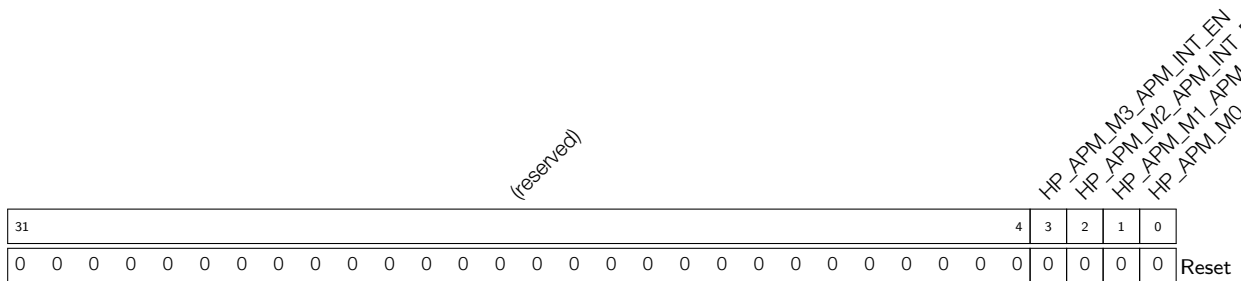

HP_APM_M0_APM_INT_EN Configures to enable APM M0 interrupt.

- 0: disable
 - 1: enable
- (R/W)

HP_APM_M1_APM_INT_EN Configures to enable APM M1 interrupt.

- 0: disable
 - 1: enable
- (R/W)

HP_APM_M2_APM_INT_EN Configures to enable APM M2 interrupt.

- 0: disable
 - 1: enable
- (R/W)

HP_APM_M3_APM_INT_EN Configures to enable APM M3 interrupt.

- 0: disable
 - 1: enable
- (R/W)

Register 15.23. HP_APM_CLOCK_GATE_REG (0x010C)

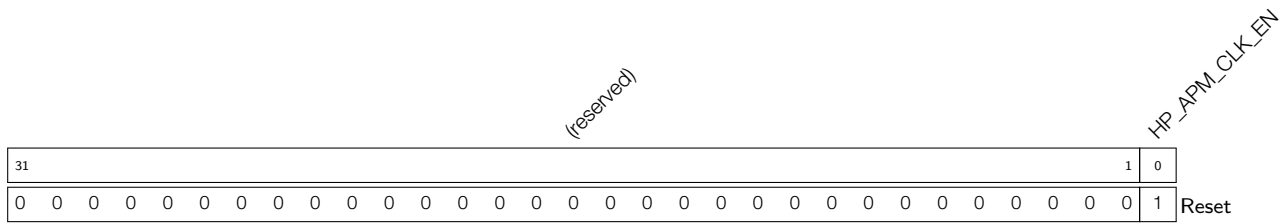

HP_APM_CLK_EN Configures whether to keep the clock always on.
 0: enable automatic clock gating
 1: keep the clock always on
 (R/W)

Register 15.24. HP_APM_DATE_REG (0x07FC)

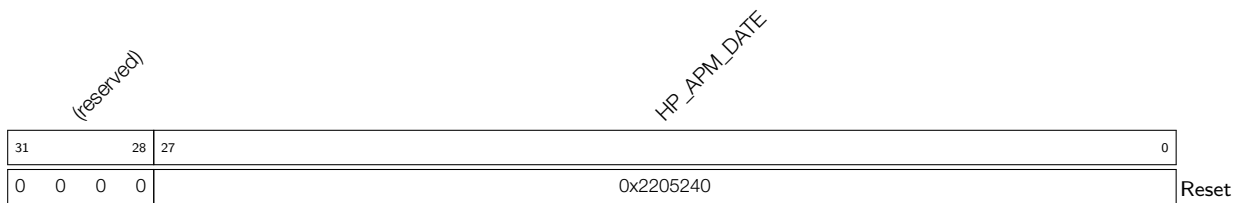

HP_APM_DATE Version control register. (R/W)

15.7.2 Low Power APM Registers (LP_APM_REG)

Register 15.25. LP_APM_REGION_FILTER_EN_REG (0x0000)

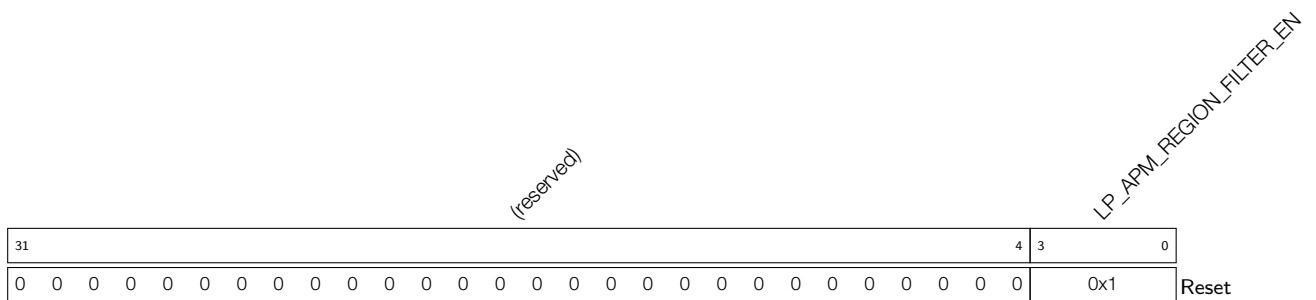

LP_APM_REGION_FILTER_EN Configure bit *n* (0-3) to enable region *n*.
 0: disable
 1: enable
 (R/W)

Register 15.26. LP_APM_REGION n _ADDR_START_REG (n : 0-3) (0x0004+0xC* n)

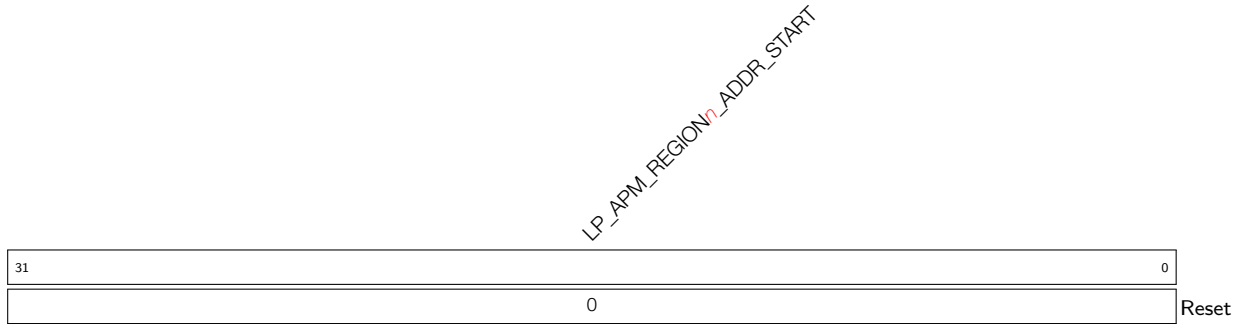

LP_APM_REGION n _ADDR_START Configures start address of region n . (R/W)

Register 15.27. LP_APM_REGION n _ADDR_END_REG (n : 0-3) (0x0008+0xC* n)

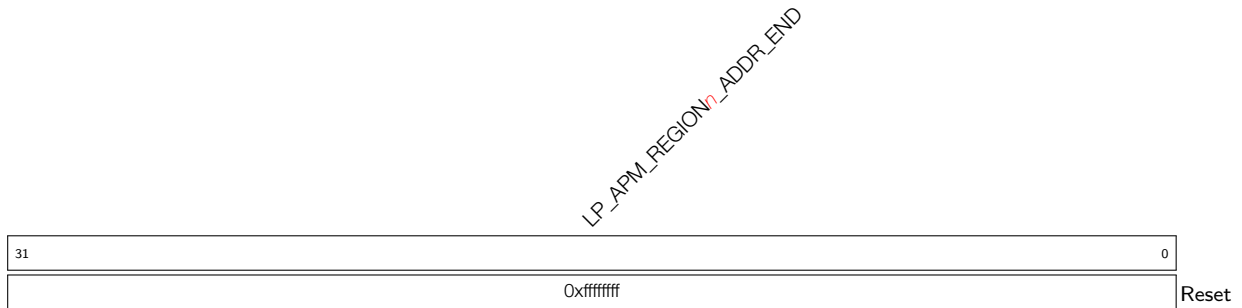

LP_APM_REGION n _ADDR_END Configures end address of region n . (R/W)

Register 15.28. LP_APM_REGION n _ATTR_REG (n : 0-3) (0x000C+0xC* n)

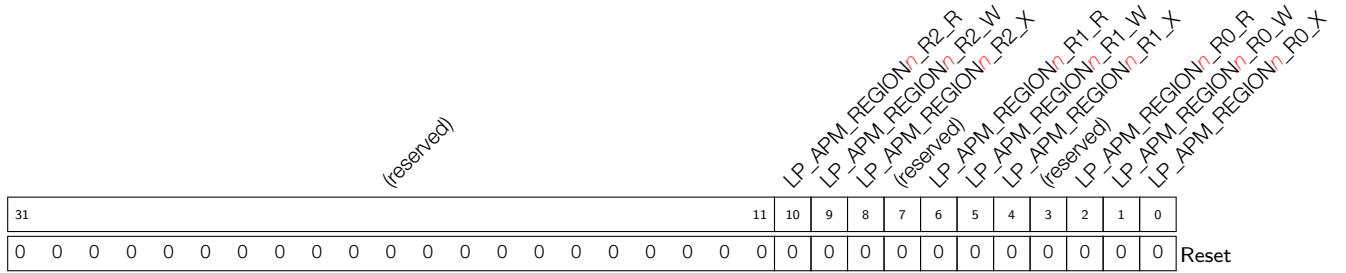

- LP_APM_REGION n _R0_X** Configures the execution authority of REE_MODE 0 in region n . (R/W)
- LP_APM_REGION n _R0_W** Configures the write authority of REE_MODE 0 in region n . (R/W)
- LP_APM_REGION n _R0_R** Configures the read authority of REE_MODE 0 in region n . (R/W)
- LP_APM_REGION n _R1_X** Configures the execution authority of REE_MODE 1 in region n . (R/W)
- LP_APM_REGION n _R1_W** Configures the write authority of REE_MODE 1 in region n . (R/W)
- LP_APM_REGION n _R1_R** Configures the read authority of REE_MODE 1 in region n . (R/W)
- LP_APM_REGION n _R2_X** Configures the execution authority of REE_MODE 2 in region n . (R/W)
- LP_APM_REGION n _R2_W** Configures the write authority of REE_MODE 2 in region n . (R/W)
- LP_APM_REGION n _R2_R** Configures the read authority of REE_MODE 2 in region n . (R/W)

Register 15.29. LP_APM_FUNC_CTRL_REG (0x00C4)

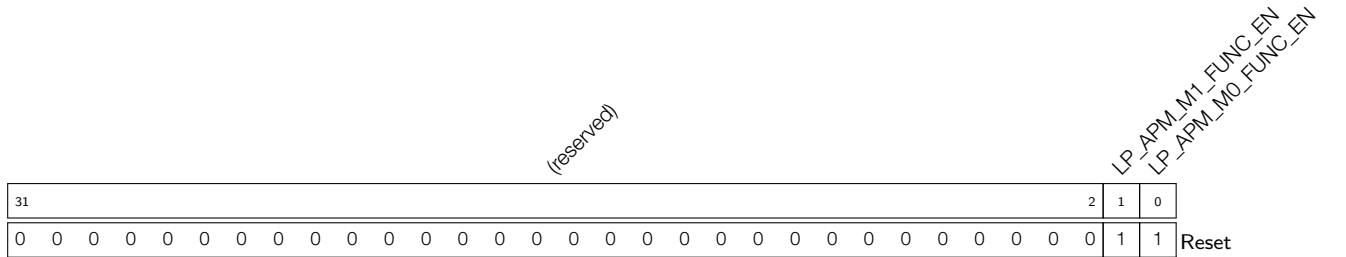

- LP_APM_M0_FUNC_EN** Configures APM M0 function enable. (R/W)
- LP_APM_M1_FUNC_EN** Configures APM M1 function enable. (R/W)

Register 15.30. LP_APM_M0_STATUS_REG (0x00C8)

(reserved)																							LP_APM_M0_EXCEPTION_STATUS			
31																								2	1	0
0																							0			Reset

LP_APM_M0_EXCEPTION_STATUS Represents exception status.

bit0: 1 represents authority_exception

bit1: 1 represents space_exception

(RO)

Register 15.31. LP_APM_M0_STATUS_CLR_REG (0x00CC)

(reserved)																							LP_APM_M0_REGION_STATUS_CLR				
31																										1	0
0																							0		Reset		

LP_APM_M0_REGION_STATUS_CLR Configures to clear exception status. (WT)

Register 15.32. LP_APM_M0_EXCEPTION_INFO0_REG (0x00D0)

(reserved)										LP_APM_M0_EXCEPTION_ID					LP_APM_M0_EXCEPTION_MODE					(reserved)					LP_APM_M0_EXCEPTION_REGION							
31										23	22					18	17	16	15											4	3	0
0										0					0					0					0			Reset				

LP_APM_M0_EXCEPTION_REGION Represents exception region. (RO)

LP_APM_M0_EXCEPTION_MODE Represents exception mode. (RO)

LP_APM_M0_EXCEPTION_ID Represents exception id information. (RO)

Register 15.33. LP_APM_M0_EXCEPTION_INFO1_REG (0x00D4)

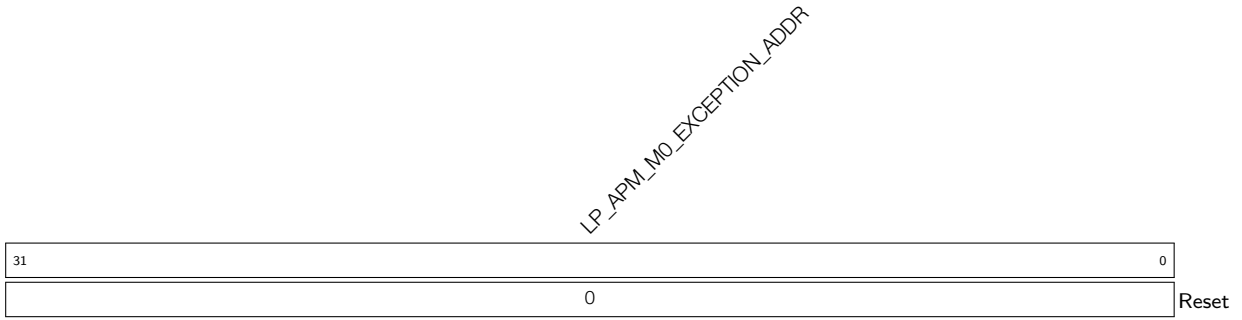

LP_APM_M0_EXCEPTION_ADDR Represents exception addr. (RO)

Register 15.34. LP_APM_M1_STATUS_REG (0x00D8)

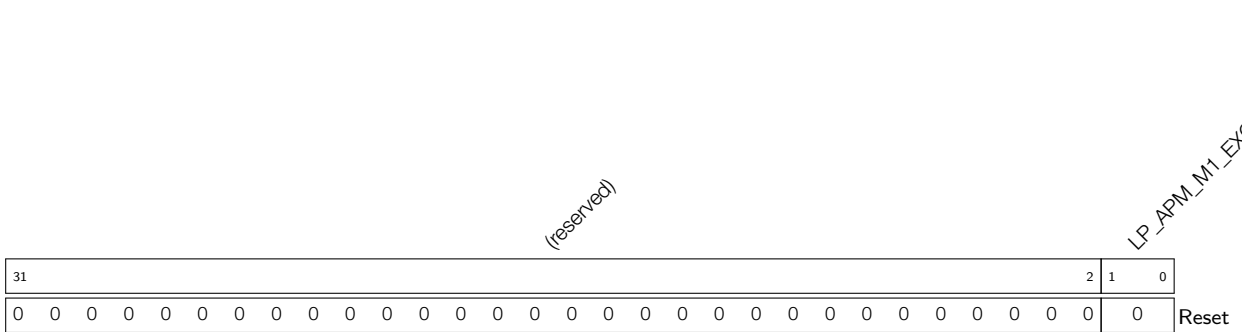

LP_APM_M1_EXCEPTION_STATUS Represents exception status.

bit0: 1 represents authority_exception

bit1: 1 represents space_exception

(RO)

Register 15.35. LP_APM_M1_STATUS_CLR_REG (0x00DC)

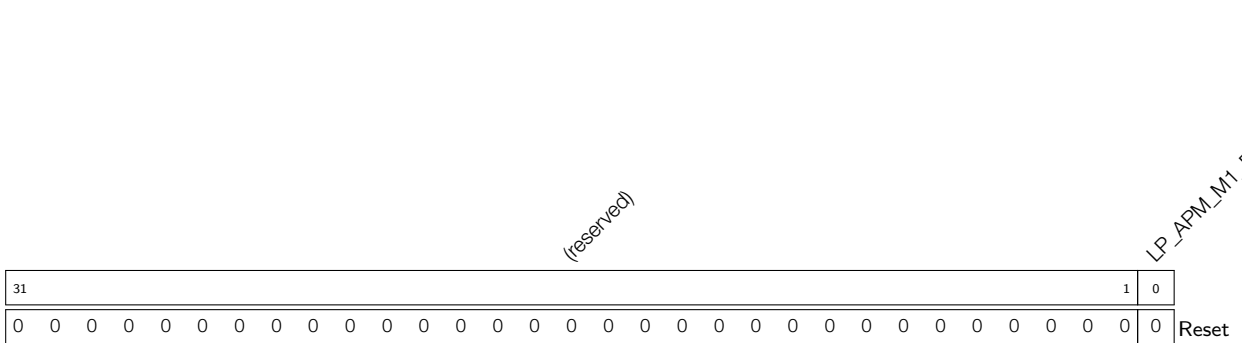

LP_APM_M1_REGION_STATUS_CLR Configures to clear exception status. (WT)

Register 15.36. LP_APM_M1_EXCEPTION_INFO0_REG (0x00E0)

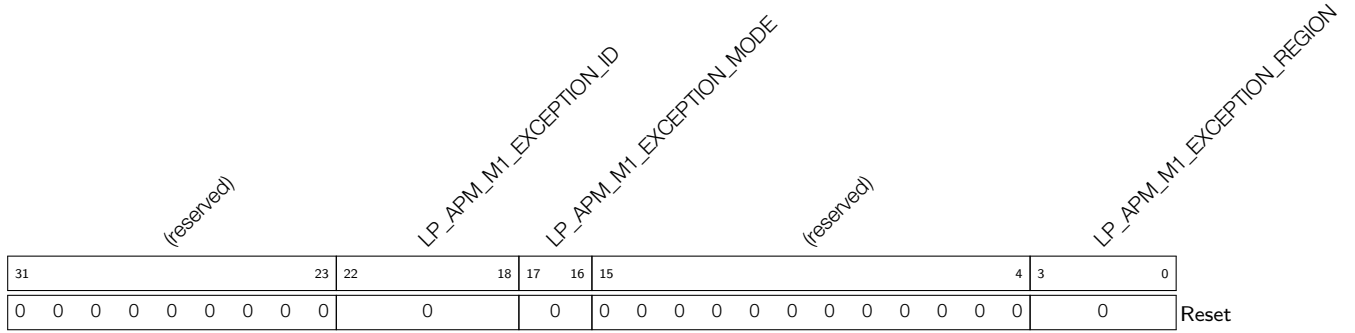

LP_APM_M1_EXCEPTION_REGION Represents exception region. (RO)

LP_APM_M1_EXCEPTION_MODE Represents exception mode. (RO)

LP_APM_M1_EXCEPTION_ID Represents exception id information. (RO)

Register 15.37. LP_APM_M1_EXCEPTION_INFO1_REG (0x00E4)

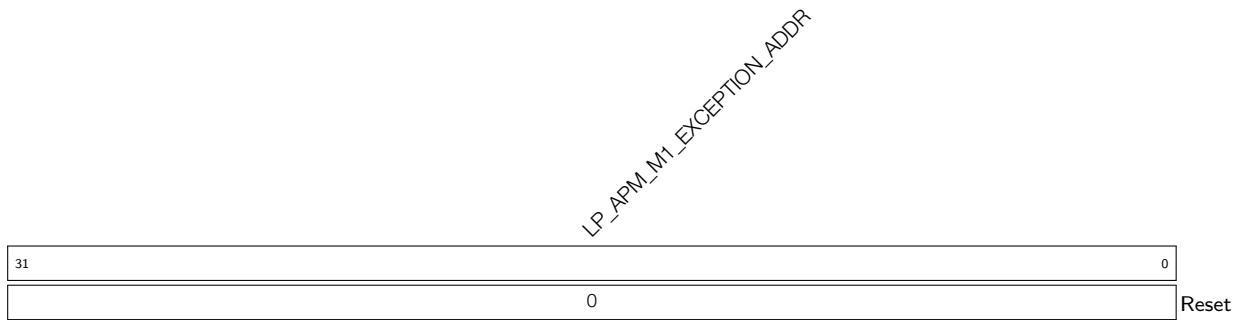

LP_APM_M1_EXCEPTION_ADDR Represents exception addr. (RO)

Register 15.38. LP_APM_INT_EN_REG (0x00E8)

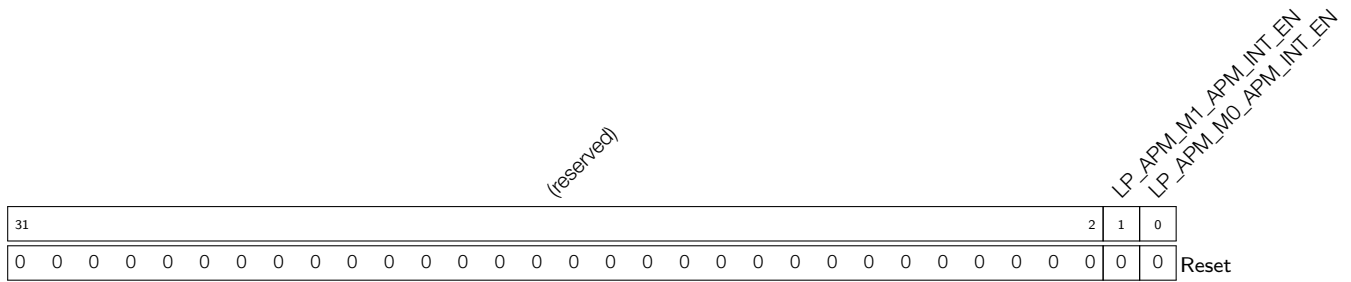

LP_APM_M0_APM_INT_EN Configures to enable APM M0 interrupt.

0: disable

1: enable

(R/W)

LP_APM_M1_APM_INT_EN Configures to enable APM M1 interrupt.

0: disable

1: enable

(R/W)

Register 15.39. LP_APM_CLOCK_GATE_REG (0x00EC)

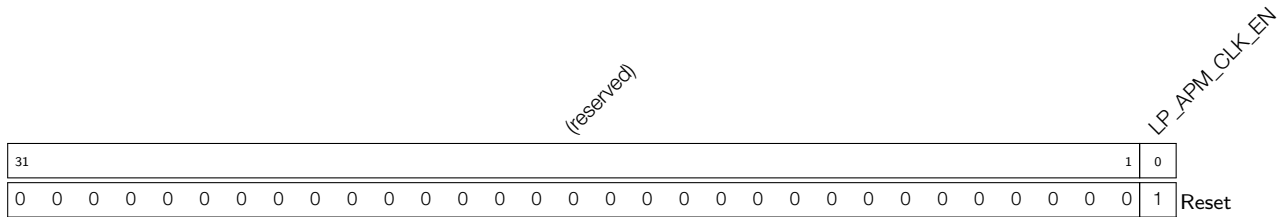

LP_APM_CLK_EN Configures whether to keep the clock always on.

0: enable automatic clock gating

1: keep the clock always on

(R/W)

Register 15.40. LP_APM_DATE_REG (0x00FC)

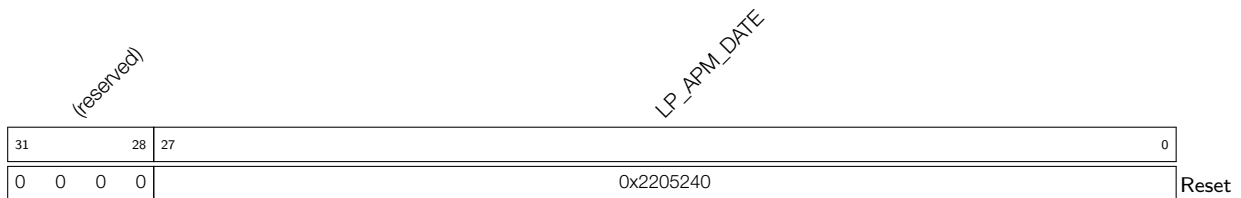

LP_APM_DATE Version control register. (R/W)

15.7.3 Low Power APM0 Registers (LP_APM0_REG)

Register 15.41. LP_APM0_REGION_FILTER_EN_REG (0x0000)

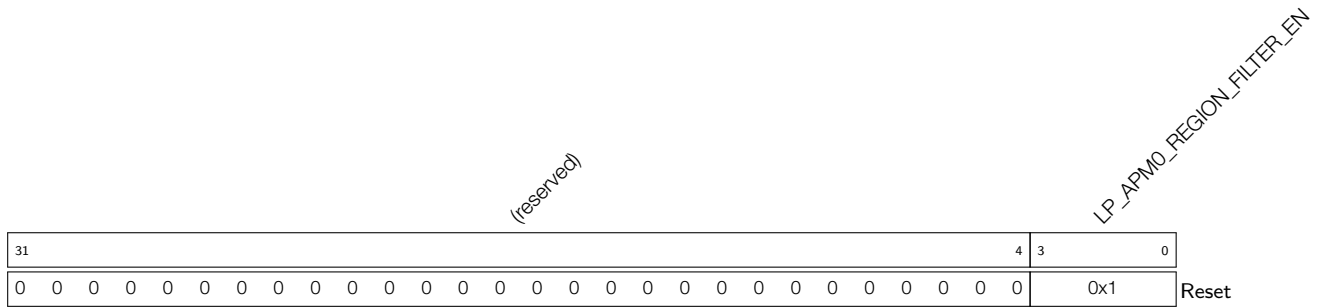

LP_APM0_REGION_FILTER_EN Configure bit n (0-3) to enable region n .
 0: disable
 1: enable
 (R/W)

Register 15.42. LP_APM0_REGION n _ADDR_START_REG (n : 0-3) (0x0004+0xC* n)

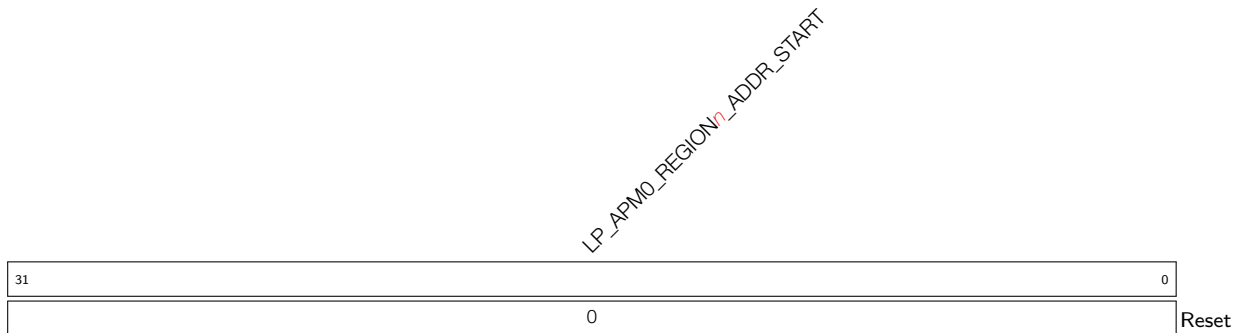

LP_APM0_REGION n _ADDR_START Configures start address of region n (R/W)

Register 15.43. LP_APM0_REGION n _ADDR_END_REG (n : 0-3) (0x0008+0xC* n)



LP_APM0_REGION n _ADDR_END Configures end address of region n (R/W)

Register 15.44. LP_APM0_REGION n _ATTR_REG (n : 0-3) (0x000C+0xC* n)

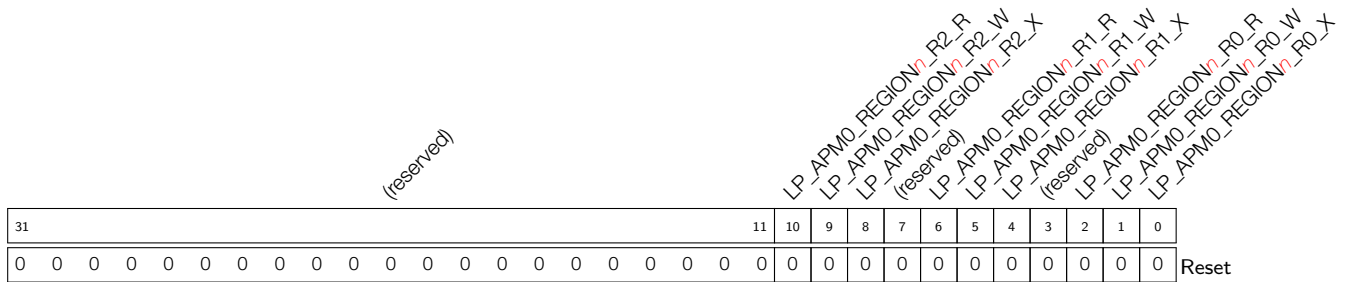

- LP_APM0_REGION n _R0_X** Configures region execute authority in REE_MODE0 (R/W)
- LP_APM0_REGION n _R0_W** Configures region write authority in REE_MODE0 (R/W)
- LP_APM0_REGION n _R0_R** Configures region read authority in REE_MODE0 (R/W)
- LP_APM0_REGION n _R1_X** Configures region execute authority in REE_MODE1 (R/W)
- LP_APM0_REGION n _R1_W** Configures region write authority in REE_MODE1 (R/W)
- LP_APM0_REGION n _R1_R** Configures region read authority in REE_MODE1 (R/W)
- LP_APM0_REGION n _R2_X** Configures region execute authority in REE_MODE2 (R/W)
- LP_APM0_REGION n _R2_W** Configures region write authority in REE_MODE2 (R/W)
- LP_APM0_REGION n _R2_R** Configures region read authority in REE_MODE2 (R/W)

Register 15.45. LP_APM0_FUNC_CTRL_REG (0x00C4)

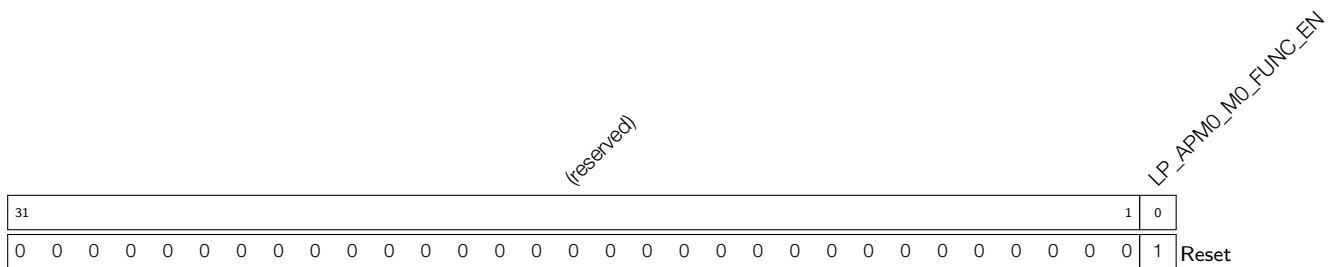

- LP_APM0_M0_FUNC_EN** Configures to enable APM M0 function. (R/W)

Register 15.46. LP_APM0_M0_STATUS_REG (0x00C8)

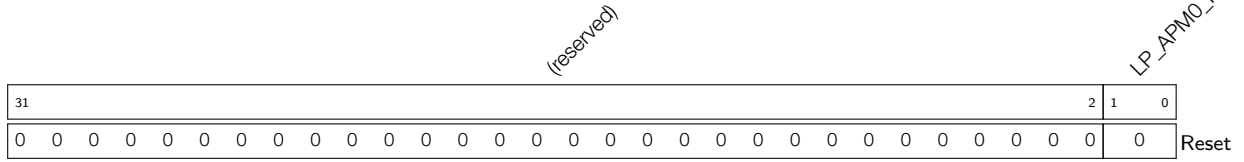

LP_APM0_M0_EXCEPTION_STATUS Represents exception status.

bit0: 1 represents authority_exception

bit1: 1 represents space_exception

(RO)

Register 15.47. LP_APM0_M0_STATUS_CLR_REG (0x00CC)

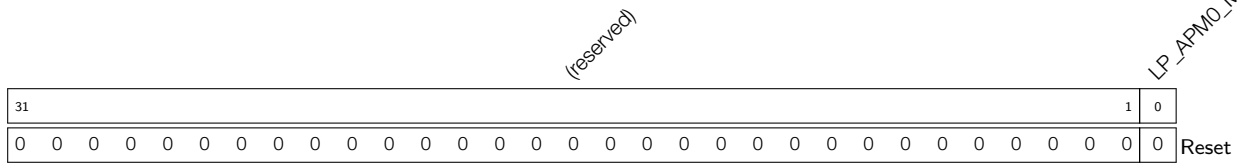

LP_APM0_M0_REGION_STATUS_CLR Configures to clear exception status (WT)

Register 15.48. LP_APM0_M0_EXCEPTION_INFO0_REG (0x00D0)

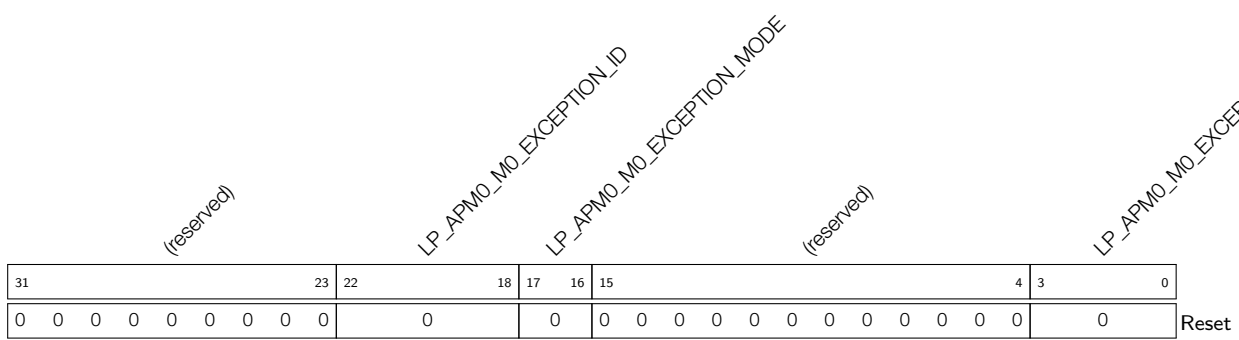

LP_APM0_M0_EXCEPTION_REGION Represents exception region (RO)

LP_APM0_M0_EXCEPTION_MODE Represents exception mode (RO)

LP_APM0_M0_EXCEPTION_ID Represents exception id information (RO)

Register 15.49. LP_APM0_M0_EXCEPTION_INFO1_REG (0x00D4)

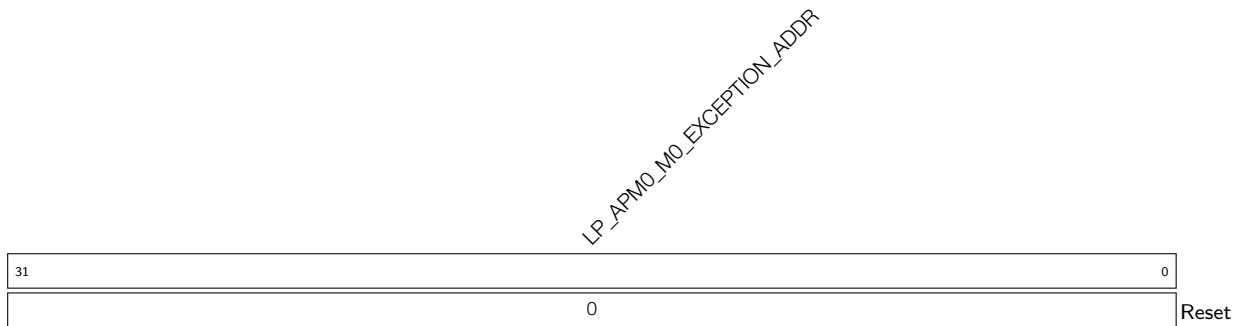

LP_APM0_M0_EXCEPTION_ADDR Represents exception addr (RO)

Register 15.50. LP_APM0_INT_EN_REG (0x00D8)

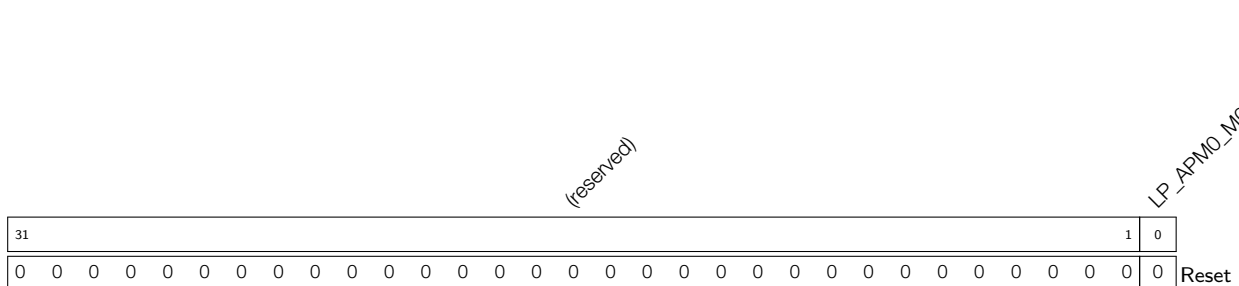

LP_APM0_M0_APM_INT_EN Configures APM M0 interrupt enable.
 0: disable
 1: enable
 (R/W)

Register 15.51. LP_APM0_CLOCK_GATE_REG (0x00DC)

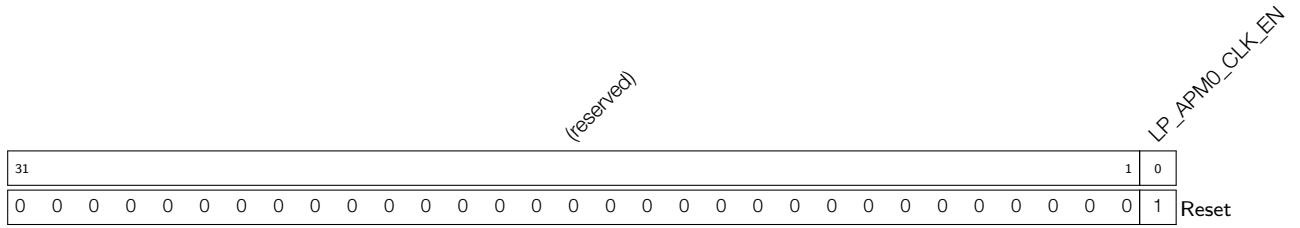

LP_APM0_CLK_EN Configures whether to keep the clock always on.
 0: enable automatic clock gating
 1: keep the clock always on
 (R/W)

Register 15.52. LP_APM0_DATE_REG (0x07FC)

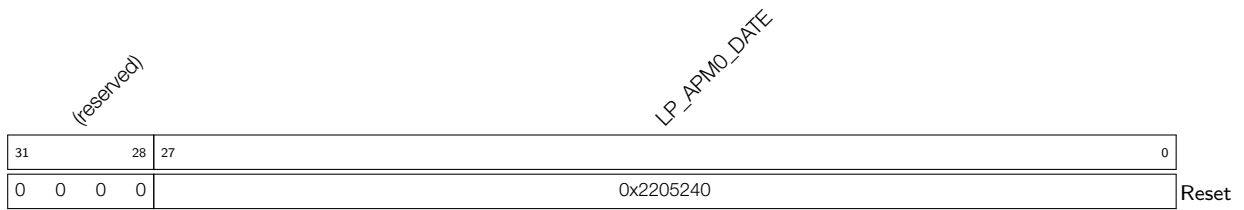

LP_APM0_DATE Version control register (R/W)

15.7.4 High Performance TEE Registers

Register 15.53. TEE_Mn_MODE_CTRL_REG (n: 0-31) (0x0000+0x4*n)

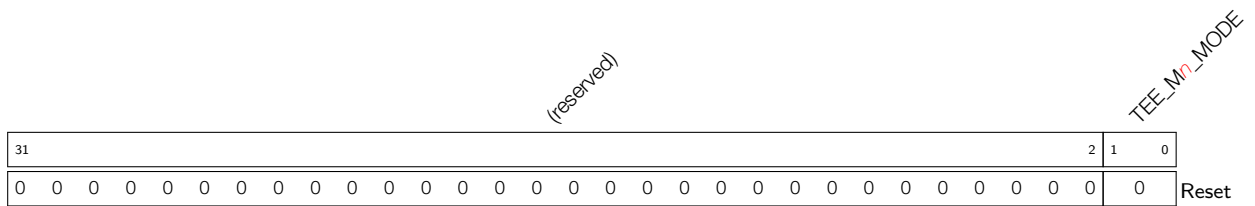

TEE_Mn_MODE Configures Mn security level mode.
 0: tee_mode
 1: ree_mode0
 2: ree_mode1
 3: ree_mode2
 (R/W)

Register 15.54. TEE_CLOCK_GATE_REG (0x0080)



TEE_CLK_EN Configures whether to keep the clock always on.
 0: enable automatic clock gating
 1: keep the clock always on
 (R/W)

Register 15.55. TEE_DATE_REG (0x0FFC)

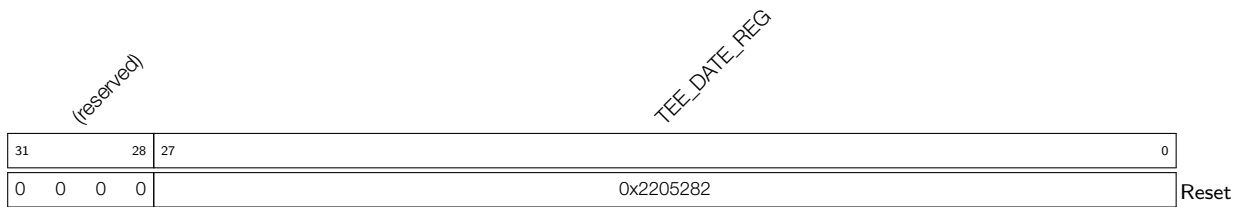

TEE_DATE_REG Version control register (R/W)

15.7.5 Low Power TEE Registers

Register 15.56. LP_TEE_M0_MODE_CTRL_REG (0x0000)

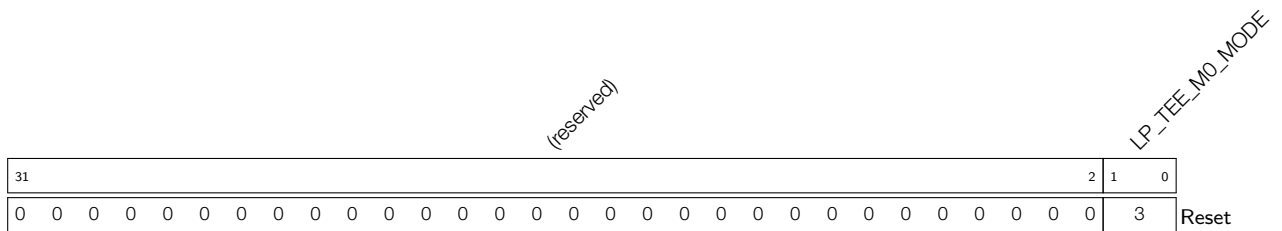

LP_TEE_M0_MODE Configures M0 security level mode.
 0: tee_mode
 1: ree_mode0
 2: ree_mode1
 3: ree_mode2
 (R/W)

Register 15.57. LP_TEE_CLOCK_GATE_REG (0x0004)

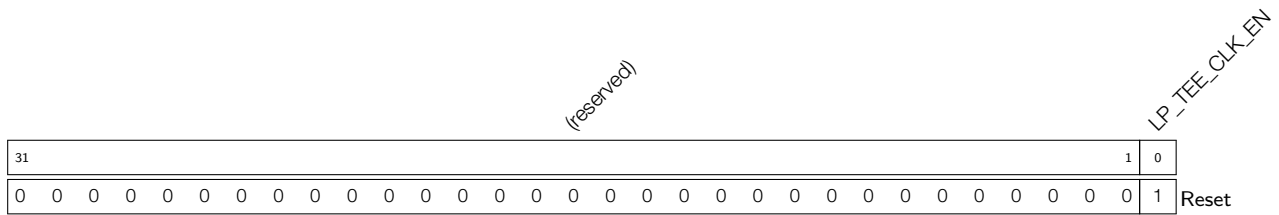

LP_TEE_CLK_EN Configures whether to keep the clock always on.

0: enable automatic clock gating

1: keep the clock always on

(R/W)

Register 15.58. LP_TEE_FORCE_ACC_HP_REG (0x0090)

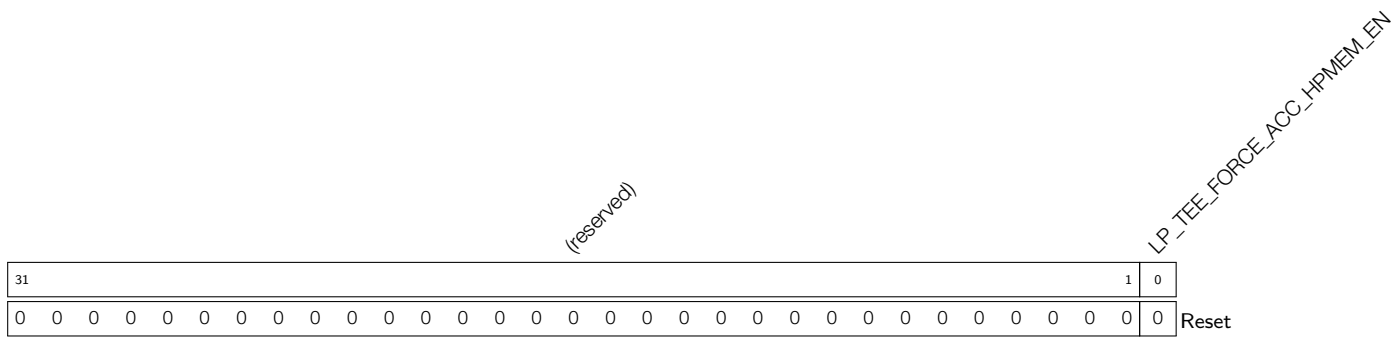

LP_TEE_FORCE_ACC_HPMEM_EN Configures whether to allow LP CPU to force access to HP_MEM regardless of permission management.

0: disable force access HP_MEM

1: enable force access HP_MEM

(R/W)

Register 15.59. LP_TEE_DATE_REG (0x00FC)

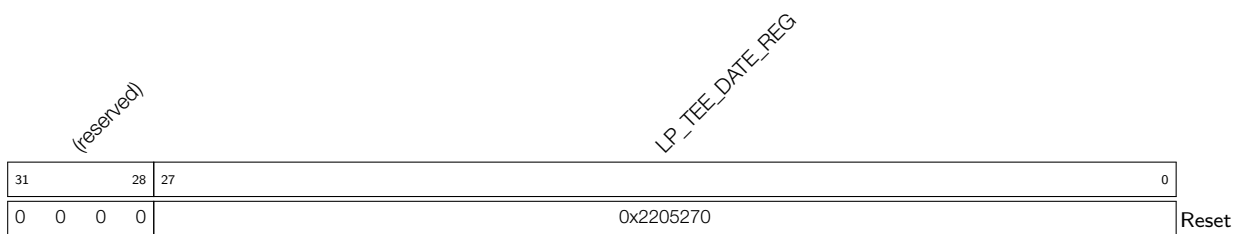

LP_TEE_DATE_REG Version control register (R/W)

16 System Registers (HP_SYSTEM)

16.1 Overview

ESP32-C6 supports a set of auxiliary chip features listed in subsection [16.2 Features](#) below, which are configured via registers. This chapter provides a description of the registers used to configure these features.

16.2 Features

ESP32-C6 system registers can be used to control the following peripheral blocks and core modules:

- External Memory Encryption/Decryption
- Anti-DPA attack security
- Software ROM Table Register
- HP Core/LP Core debug
- Bus timeout protection

16.3 Function Description

16.3.1 External Memory Encryption/Decryption Configuration

[HP_SYSTEM_EXTERNAL_DEVICE_ENCRYPT_DECRYPT_CONTROL_REG](#) configures encryption and decryption options of the external memory. For details, please refer to Chapter [24 External Memory Encryption and Decryption \(XTS_AES\)](#).

16.3.2 Anti-DPA Attack Security Control

ESP32-C6 has a dual protection mechanism against Differential Power Analysis (DPA) attacks at the hardware level.

- First, a mask mechanism is introduced in the symmetric encryption operation process, which interferes with the power consumption trajectory by masking the real data in the operation process. This security mechanism cannot be turned off.
- Second, the clock selected for the operation will change dynamically in real time, blurring the power consumption trajectory during the operation. For this security mechanism, ESP32-C6 provides 4 security levels for users to choose to adapt to different applications.

Table 16-1. Security Level

Security-Level Name	Security-Level Value	PLL_CLK (MHz)	XTAL_CLK (MHz)
SEC_DPA_OFF	0	160	40
SEC_DPA_LOW	1	(120,160] ^A	(20,40] ^A
SEC_DPA_MIDDLE	2	(96,160] ^A	(33.3,40] ^A
SEC_DPA_HIGH	3	(80,160] ^A	(10,40] ^A

^A (x,y] means the operating frequency is greater than x Hz, and equal to or less than y Hz.

By default, the field `HP_SYSTEM_SEC_DPA_CFG_SEL` in register `HP_SYSTEM_SEC_DPA_CONF_REG` is 0. In this case, the security-level is decided by the eFuse field `EFUSE_SEC_DPA_LEVEL`. If the field `HP_SYSTEM_SEC_DPA_CFG_SEL` is set to 1, the security-level is decided by `HP_SYSTEM_SEC_DPA_CFG_LEVEL` in register `HP_SYSTEM_SEC_DPA_CONF_REG`.

16.3.3 Software ROM Table Register

ESP32-C6 provides two special registers: `HP_SYSTEM_ROM_TABLE_LOCK_REG` and `HP_SYSTEM_ROM_TABLE_REG`. The value of `HP_SYSTEM_ROM_TABLE_LOCK_REG` can only be 0 or 1. `HP_SYSTEM_ROM_TABLE_REG` contains 32 available bits which can be modified/read by the users.

When the value of `HP_SYSTEM_ROM_TABLE_LOCK_REG` is 0, the value of the `HP_SYSTEM_ROM_TABLE_REG` register can be repeatedly modified or read by software. After the value of `HP_SYSTEM_ROM_TABLE_LOCK_REG` is written to 1, the value of `HP_SYSTEM_ROM_TABLE_LOCK_REG` cannot be modified and can only be read.

These two registers can be used as a supplement to ROM to store some special/important configuration values.

It should be noted that while Core Reset would reset `HP_SYSTEM_ROM_TABLE_LOCK_REG` and `HP_SYSTEM_ROM_TABLE_REG`, CPU Reset is unable to reset these two registers. For more information on reset types, please refer to the Subsection [8.1.3 Features](#) in Chapter [8 Reset and Clock](#).

16.3.4 HP Core/LP Core Debug Control

The following register is used to debug between HP CPU and LP CPU. For more information on how to debug HP CPU and LP CPU, please refer to the Subsection [1.10 Debug](#) in Chapter [1 High-Performance CPU](#).

- `HP_SYSTEM_CORE_DEBUG_RUNSTALL_ENABLE`: Enable this bit to enable debug RunStall feature between HP CPU and LP CPU.

16.3.5 Bus Timeout Protection

The Bus Timeout Protection function can be enabled and the timeout threshold can be configured through the configuration register. When a transfer is initiated, the counter inside the Timeout Protection module will increase by one every clock cycle. When the accumulated value is less than the timeout threshold and the bus receives a response from the slave, the internal counter is cleared. When the accumulated value is greater than the timeout threshold, if the slave device has not responded to the transfer, the Timeout Protection module will force the bus return signal to be pulled high. At the same time, it will report the interrupt and record the abnormal access address and master ID.

16.3.5.1 CPU Peripheral Timeout Protection Register

`HP_SYSTEM_CPU_PERI_TIMEOUT_CONF_REG` is the timeout protection configuration register for accessing CPU peripheral registers. CPU peripherals refer to the peripherals or modules whose addresses are in the range of `0x600C_0000 ~ 0x600C_FFFF`. For corresponding peripheral information, please refer to Subsection [5.3.5 Modules/Peripherals Address Mapping](#) in Chapter [5 System and Memory](#).

When a timeout occurs, the `CPU_PERI_TIMEOUT_INTR` interrupt will be asserted.

- `HP_SYSTEM_CPU_PERI_TIMEOUT_CONF_REG`: Enables timeout protection and configures the timeout threshold.

- [HP_SYSTEM_CPU_PERI_TIMEOUT_ADDR_REG](#): When a timeout occurs, this register will record the address of the timeout.
- [HP_SYSTEM_CPU_PERI_TIMEOUT_UID_REG](#): When a timeout occurs, this register will record the address of the timeout.

16.3.5.2 HP Peripheral Timeout Protection Register

[HP_SYSTEM_HP_PERI_TIMEOUT_CONF_REG](#) is the timeout protection configuration register for accessing HP peripheral registers.

HP peripherals refer to the peripherals or modules whose addresses are in the range of 0x6000_0000 ~ 0x6009_FFFF. For corresponding peripheral information, please refer to Subsection [5.3.5 Modules/Peripherals Address Mapping](#) in Chapter [5 System and Memory](#).

When a timeout occurs, the [HP_PERI_TIMEOUT_INTR](#) interrupt will be asserted.

- [HP_SYSTEM_HP_PERI_TIMEOUT_CONF_REG](#): Enables timeout protection and configures the timeout threshold.
- [HP_SYSTEM_HP_PERI_TIMEOUT_ADDR_REG](#): When a timeout occurs, this register will record the address of the timeout.
- [HP_SYSTEM_HP_PERI_TIMEOUT_UID_REG](#): When a timeout occurs, this register will record the Master-ID of the timeout.

16.3.5.3 LP Peripheral Timeout Protection Register

[LP_PERI_BUS_TIMEOUT_CONF_REG](#) is the timeout protection configuration register for accessing LP peripheral registers. LP peripherals refer to the peripherals or modules whose addresses are in the range of 0x600B_0000 ~ 0x600B_FFFF. For corresponding peripheral information, please refer to Subsection [5.3.5 Modules/Peripherals Address Mapping](#) in Chapter [5 System and Memory](#).

When a timeout occurs, the [LP_PERI_TIMEOUT_INTR](#) interrupt will be asserted.

- [LP_PERI_BUS_TIMEOUT_CONF_REG](#): Enables timeout protection and configures the timeout threshold.
- [LP_PERI_BUS_TIMEOUT_ADDR_REG](#): When a timeout occurs, this register will record the address of the timeout.
- [LP_PERI_BUS_TIMEOUT_UID_REG](#): When a timeout occurs, this register will record the Master-ID of the timeout.

16.4 Register Summary

The addresses in this section are relative to System Registers base address provided in Table 5-2 in Chapter 5 *System and Memory*.

The abbreviations given in Column **Access** are explained in Section *Access Types for Registers*.

Name	Description	Address	Access
Configuration Register			
HP_SYSTEM_EXTERNAL_DEVICE_ENCRYPT_DECRYPT_CONTROL_REG	External device encryption/decryption configuration register	0x0000	R/W
HP_SYSTEM_SEC_DPA_CONF_REG	HP anti-DPA security configuration register	0x0008	R/W
HP_SYSTEM_ROM_TABLE_LOCK_REG	ROM-Table lock register	0x0038	R/W
HP_SYSTEM_ROM_TABLE_REG	ROM-Table register	0x003C	R/W
HP_SYSTEM_CORE_DEBUG_RUNSTALL_CONF_REG	Core Debug RunStall configuration register	0x0040	R/W
CPU Peripheral Timeout Register			
HP_SYSTEM_CPU_PERI_TIMEOUT_CONF_REG	CPU Peripheral Timeout configuration register	0x000C	varies
HP_SYSTEM_CPU_PERI_TIMEOUT_ADDR_REG	Abnormal access address register	0x0010	RO
HP_SYSTEM_CPU_PERI_TIMEOUT_UID_REG	Master ID and permission register	0x0014	WTC
HP Peripheral Timeout Register			
HP_SYSTEM_HP_PERI_TIMEOUT_CONF_REG	HP Peripheral Timeout configuration register	0x0018	varies
HP_SYSTEM_HP_PERI_TIMEOUT_ADDR_REG	Abnormal access address register	0x001C	RO
HP_SYSTEM_HP_PERI_TIMEOUT_UID_REG	Master ID and permission register	0x0020	WTC
LP Peripheral Timeout Register			
LP_PERI_BUS_TIMEOUT_CONF_REG	LP Peripheral timeout configuration register	0x0010	varies
LP_PERI_BUS_TIMEOUT_ADDR_REG	LP Peripheral abnormal access address register	0x0014	RO
LP_PERI_BUS_TIMEOUT_UID_REG	LP Peripheral Master ID and permission register	0x0018	WTC
Version Register			
HP_SYSTEM_DATE_REG	Date control and version control register	0x03FC	R/W

16.5 Registers

The addresses in this section are relative to System Registers base address provided in Table 5-2 in Chapter 5 *System and Memory*.

Register 16.1. HP_SYSTEM_EXTERNAL_DEVICE_ENCRYPT_DECRYPT_CONTROL_REG (0x0000)

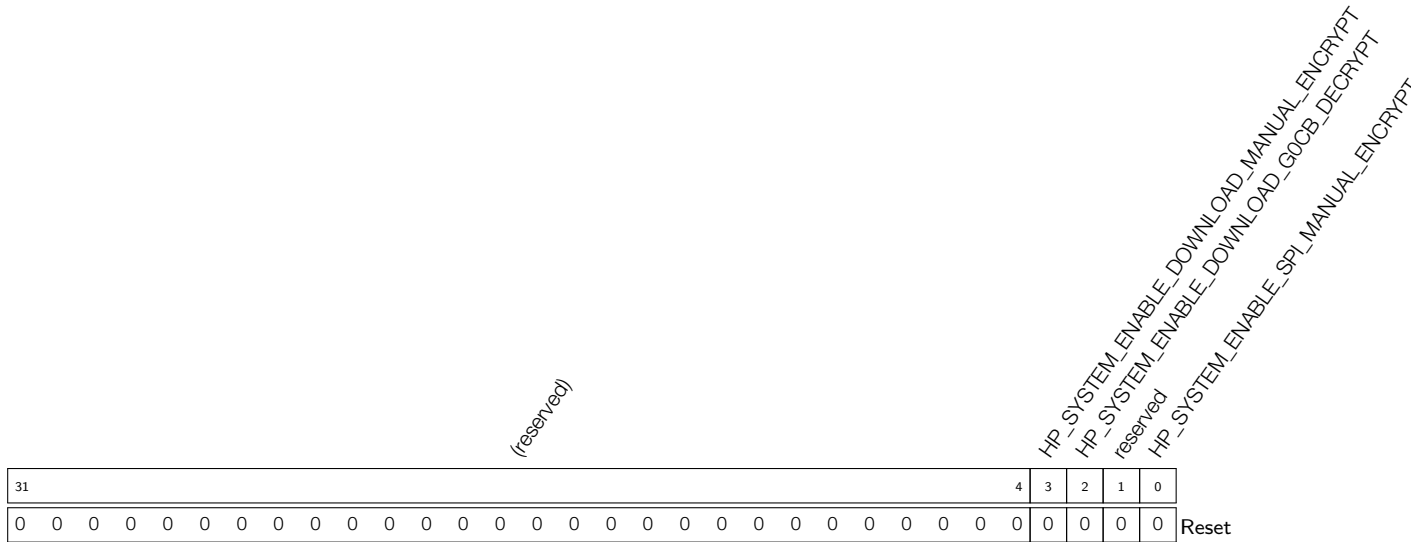

HP_SYSTEM_ENABLE_SPI_MANUAL_ENCRYPT Configures whether or not to enable MSPI XTS manual encryption in SPI boot mode.
 0: Disable
 1: Enable
 (R/W)

HP_SYSTEM_ENABLE_DOWNLOAD_G0CB_DECRYPT Configures whether or not to enable MSPI XTS auto decryption in download boot mode.
 0: Disable
 1: Enable
 (R/W)

HP_SYSTEM_ENABLE_DOWNLOAD_MANUAL_ENCRYPT Configures whether or not to enable MSPI XTS manual encryption in download boot mode.
 0: Disable
 1: Enable
 (R/W)

Register 16.2. HP_SYSTEM_SEC_DPA_CONF_REG (0x0008)

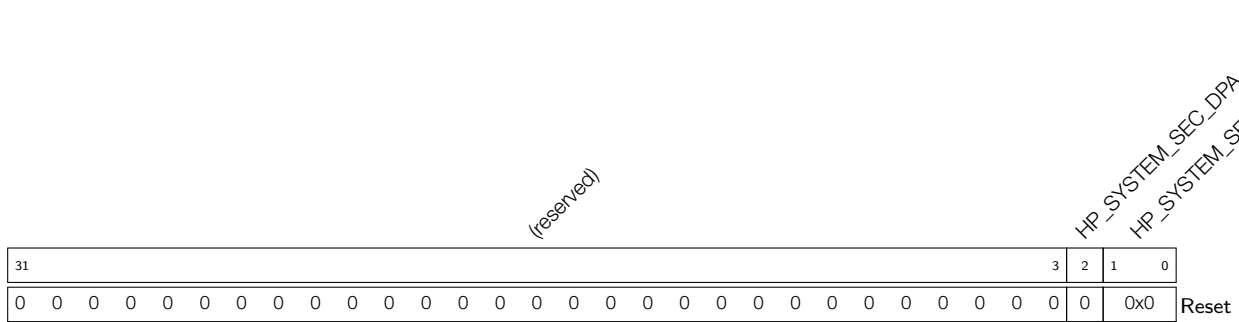

HP_SYSTEM_SEC_DPA_LEVEL Configures whether or not to enable anti-DPA attack. Valid only when [HP_SYSTEM_SEC_DPA_CFG_SEL](#) is 0.

0: Disable

1-3: Enable. The larger the number, the higher the security level, which represents the ability to resist DPA attacks, with increased computational overhead of the hardware crypto-accelerators at the same time.

(R/W)

HP_SYSTEM_SEC_DPA_CFG_SEL Configures whether to select [HP_SYSTEM_SEC_DPA_LEVEL](#) or [EFUSE_SEC_DPA_LEVEL](#) (from eFuse) to control DPA level.

0: Select [EFUSE_SEC_DPA_LEVEL](#)

1: Select [HP_SYSTEM_SEC_DPA_LEVEL](#)

(R/W)

Register 16.3. HP_SYSTEM_ROM_TABLE_LOCK_REG (0x0038)

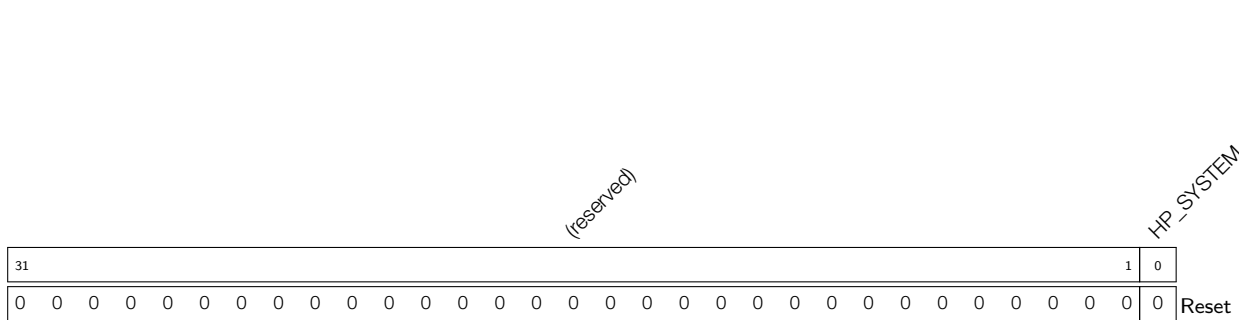

HP_SYSTEM_ROM_TABLE_LOCK Configures whether or not to lock the value contained in [HP_SYSTEM_ROM_TABLE](#).

0: Unlock

1: Lock

(R/W)

Register 16.4. HP_SYSTEM_ROM_TABLE_REG (0x003C)

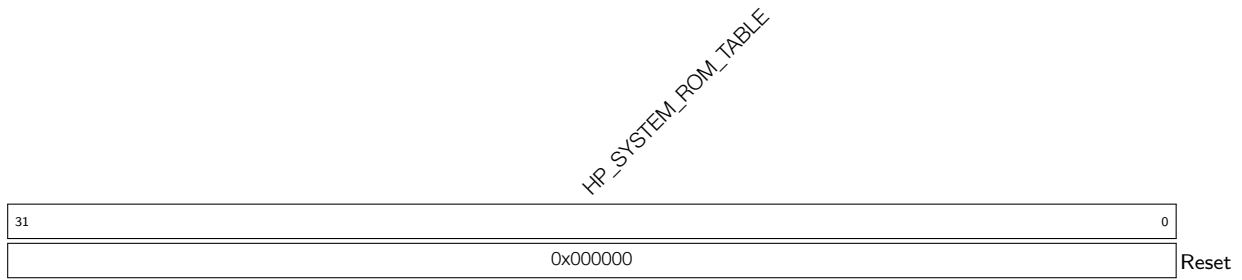

HP_SYSTEM_ROM_TABLE Software ROM-Table register, whose content can be modified only when [HP_SYSTEM_ROM_TABLE_LOCK](#) is 0. (R/W)

Register 16.5. HP_SYSTEM_CORE_DEBUG_RUNSTALL_CONF_REG (0x0040)

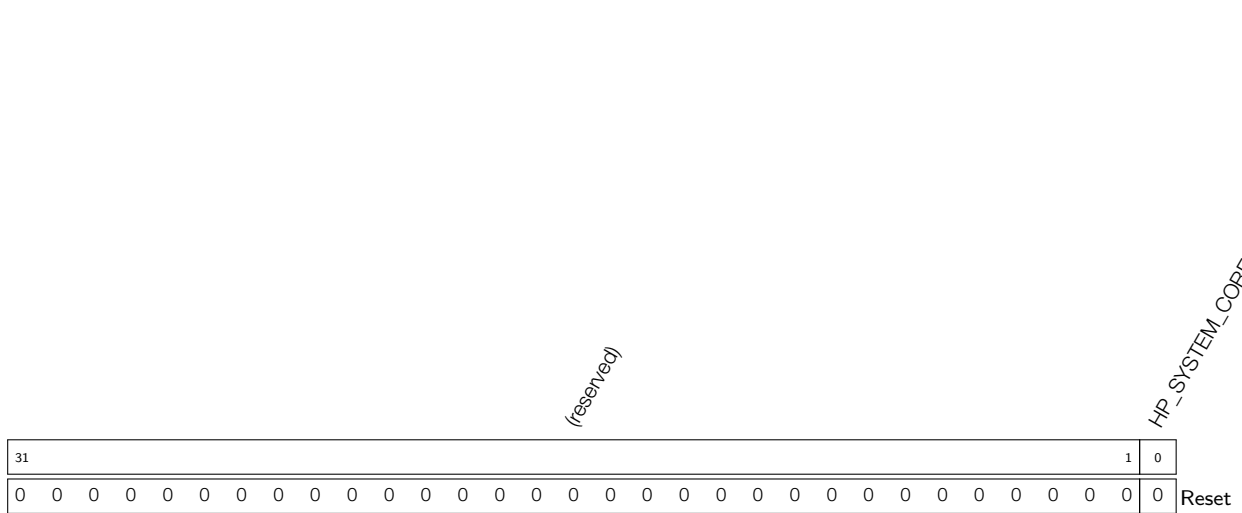

HP_SYSTEM_CORE_DEBUG_RUNSTALL_ENABLE Configures whether or not to enable debug RunStall functionality between HP CPU and LP CPU.
 0: Disable
 1: Enable
 (R/W)

Register 16.6. HP_SYSTEM_CPU_PERI_TIMEOUT_CONF_REG (0x000C)

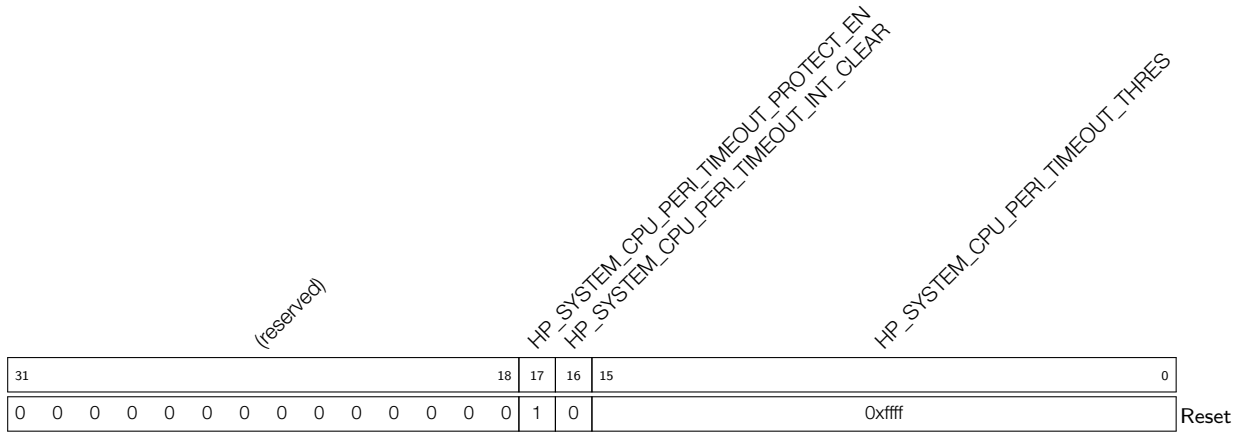

HP_SYSTEM_CPU_PERI_TIMEOUT_THRES Configures the timeout threshold for bus access for accessing CPU peripheral register in the number of clock cycles of the clock domain. (R/W)

HP_SYSTEM_CPU_PERI_TIMEOUT_INT_CLEAR Write 1 to clear timeout interrupt. (WT)

HP_SYSTEM_CPU_PERI_TIMEOUT_PROTECT_EN Configures whether or not to enable timeout protection for accessing CPU peripheral registers.

0: Disable

1: Enable

(R/W)

Register 16.7. HP_SYSTEM_CPU_PERI_TIMEOUT_ADDR_REG (0x0010)

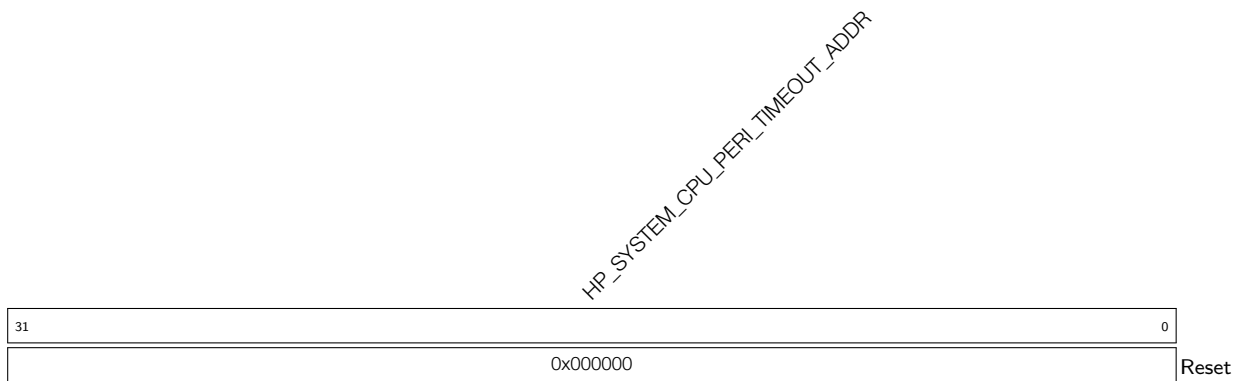

HP_SYSTEM_CPU_PERI_TIMEOUT_ADDR Represents the address information of abnormal access. (RO)

Register 16.8. HP_SYSTEM_CPU_PERI_TIMEOUT_UID_REG (0x0014)

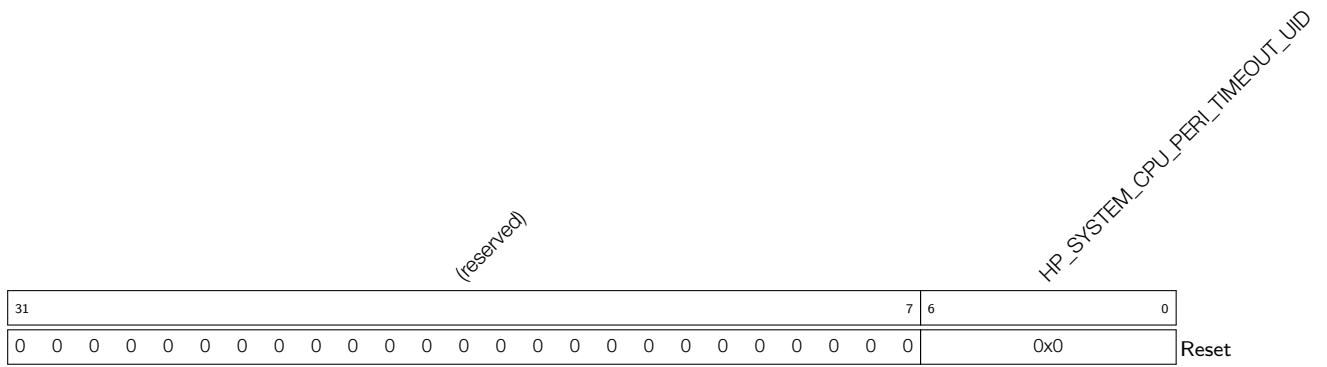

HP_SYSTEM_CPU_PERI_TIMEOUT_UID Represents the master id[4:0] and master permission[6:5] when trigger timeout. This register will be cleared after the interrupt is cleared. (WTC)

Register 16.9. HP_SYSTEM_HP_PERI_TIMEOUT_CONF_REG (0x0018)

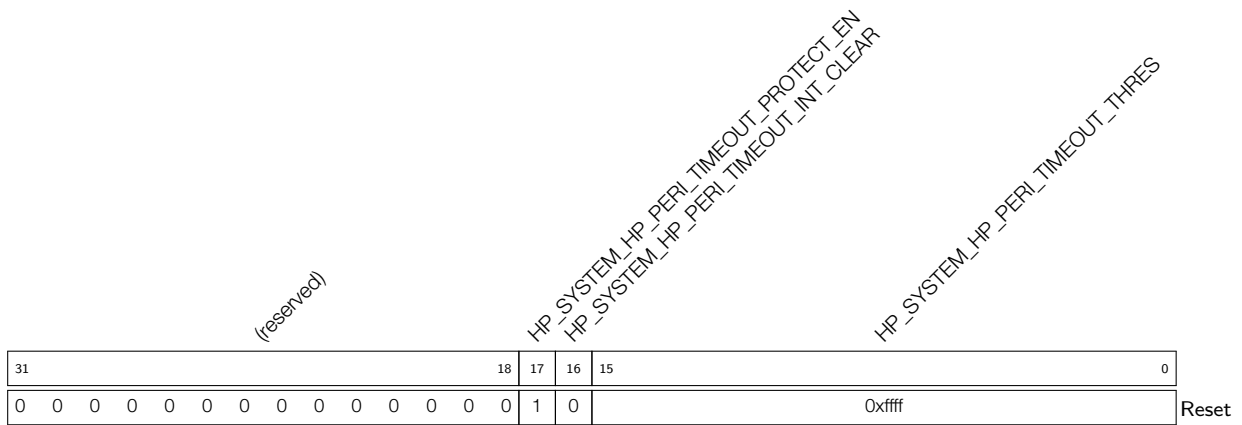

HP_SYSTEM_HP_PERI_TIMEOUT_THRES Configures the timeout threshold for bus access for accessing HP peripheral register, corresponding to the number of clock cycles of the clock domain. (R/W)

HP_SYSTEM_HP_PERI_TIMEOUT_INT_CLEAR Configures whether or not to clear timeout interrupt.
 0: No effect
 1: Clear timeout interrupt
 (WT)

HP_SYSTEM_HP_PERI_TIMEOUT_PROTECT_EN Configures whether or not to enable timeout protection for accessing HP peripheral registers.
 0: Disable
 1: Enable
 (R/W)

Register 16.10. HP_SYSTEM_HP_PERI_TIMEOUT_ADDR_REG (0x001C)

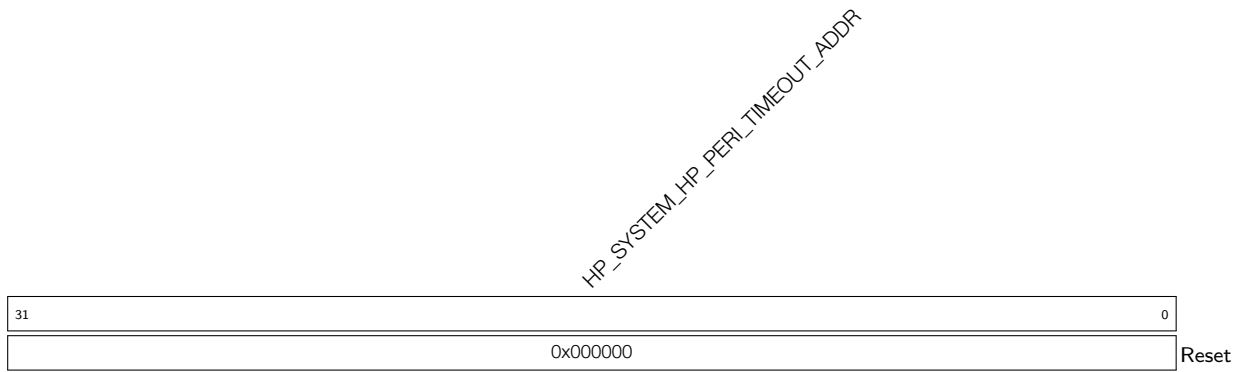

HP_SYSTEM_HP_PERI_TIMEOUT_ADDR Represents the address information of abnormal access.
(RO)

Register 16.11. HP_SYSTEM_HP_PERI_TIMEOUT_UID_REG (0x0020)

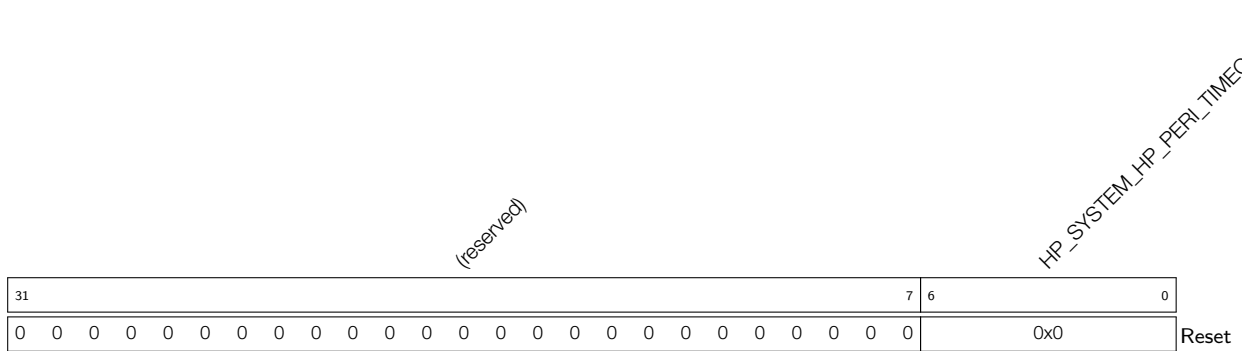

HP_SYSTEM_HP_PERI_TIMEOUT_UID Represents the master id[4:0] and master permission[6:5] when trigger timeout. This register will be cleared after the interrupt is cleared. (WTC)

Register 16.14. LP_PERI_BUS_TIMEOUT_UID_REG (0x0018)

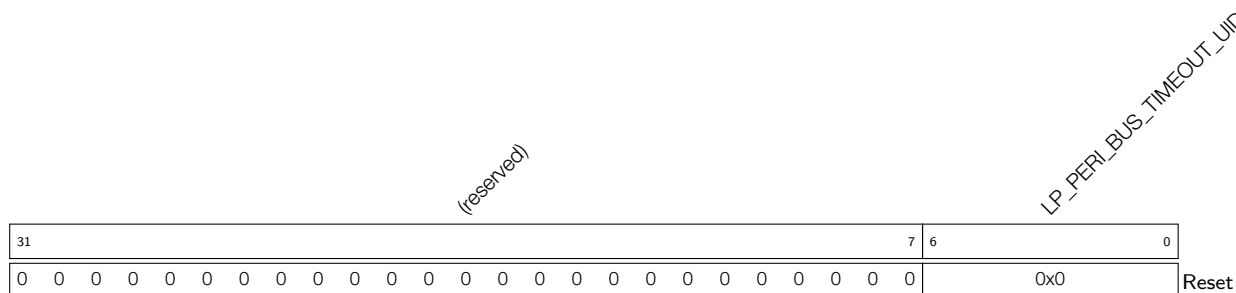

LP_PERI_BUS_TIMEOUT_UID Represents the master id[4:0] and master permission[6:5] when trigger timeout. This register will be cleared after the interrupt is cleared. (WTC)

Register 16.15. HP_SYSTEM_DATE_REG (0x03FC)

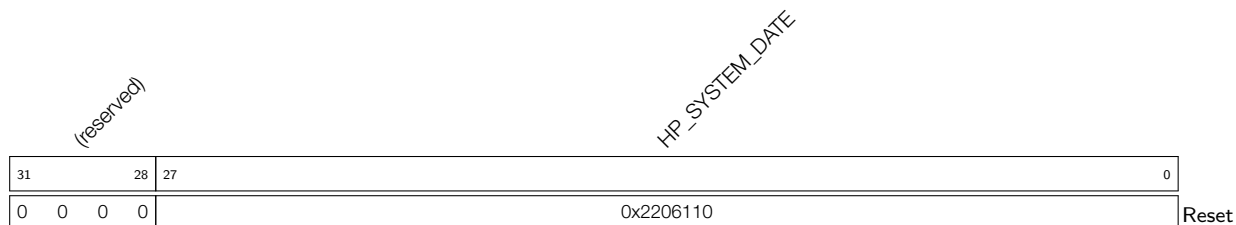

HP_SYSTEM_DATE Version control register. (R/W)

17 Debug Assistant (ASSIST_DEBUG)

17.1 Overview

Debug Assistant is an auxiliary module that features a set of functions to help locate bugs and issues during software debugging.

17.2 Features

- **Read/write monitoring:** Monitors whether the High-Performance CPU (HP CPU) bus reads from or writes to a specified memory address space. A detected read or write in the monitored address space will trigger an interrupt.
- **Stack pointer (SP) monitoring:** Monitors whether the SP exceeds the specified address space. A bounds violation will trigger an interrupt.
- **Program counter (PC) logging:** Records PC value. The developer can get the last PC value at the most recent HP CPU reset.
- **Bus access logging:** Records the information about bus access. When the HP CPU, LP CPU, or Direct Memory Access controller (DMA) writes a specified value, the Debug Assistant module will record the data type, address of this write operation, and additionally the PC value when the write is performed by the HP CPU, and push such information to the HP SRAM.

17.3 Functional Description

17.3.1 Region Read/Write Monitoring

The Debug Assistant module can monitor reads/writes performed by the HP CPU over Data bus and Peripheral bus in a certain address space, i.e., memory region. Whenever the bus reads or writes in the specified address space, an interrupt will be triggered. The Data bus can monitor two memory regions (assuming they are region 0 and region 1, defined by developers' needs) at the same time, and so can Peripheral Bus.

17.3.2 SP Monitoring

The Debug Assistant module can monitor the SP so as to prevent stack overflow or erroneous push/pop. When the stack pointer exceeds the minimum or maximum threshold, the module will record the PC pointer and generate an interrupt. The threshold is configured by software.

17.3.3 PC Logging

In some cases, software developers want to know the PC at the last HP CPU reset. For instance, when the program is stuck and can only be reset, the developer may want to know where the program got stuck in order to debug. The Debug Assistant module can record the PC at the last HP CPU reset, which can be then read for software debugging.

17.3.4 CPU/DMA Bus Access Logging

The Debug Assistant module can record the information about the HP CPU Data bus's, LP CPU bus's, and DMA bus's write behaviors in real time. When a write operation occurs in or a specific value is written to a specified

address space, the module will record the bus type, the address, PC (only when the write is performed by the HP CPU will PC be recorded), and other information, and then store the data in the HP SRAM in a certain format.

17.4 Recommended Operation

17.4.1 Region Monitoring and SP Monitoring Configuration

The Debug Assistant module can monitor reads and writes performed by the HP CPU's Data bus and Peripheral bus. Two memory regions on each bus can be monitored at the same time. All the monitoring modes supported by the Debug Assistant module are listed below:

- Monitoring of the read/write operations performed by Data bus
 - Data bus reads in region 0
 - Data bus writes in region 0
 - Data bus reads in region 1
 - Data bus writes in region 1
- Monitoring of the read/write operations performed by Peripheral bus
 - Peripheral bus reads in region 0
 - Peripheral bus writes in region 0
 - Peripheral bus reads in region 1
 - Peripheral bus writes in region 1
- Monitoring of exceeding the SP bounds
 - SP exceeds the upper bound address
 - SP exceeds the lower bound address

The configuration process for region monitoring and SP monitoring is as follows:

1. Configure monitored region and SP threshold.
 - Configure Data bus region 0 with [ASSIST_DEBUG_CORE_0_AREA_DRAM0_0_MIN_REG](#) and [ASSIST_DEBUG_CORE_0_AREA_DRAM0_0_MAX_REG](#).
 - Configure Data bus region 1 with [ASSIST_DEBUG_CORE_0_AREA_DRAM0_1_MIN_REG](#) and [ASSIST_DEBUG_CORE_0_AREA_DRAM0_1_MAX_REG](#).
 - Configure Peripheral bus region 0 with [ASSIST_DEBUG_CORE_0_AREA_PIF_0_MIN_REG](#) and [ASSIST_DEBUG_CORE_0_AREA_PIF_0_MAX_REG](#).
 - Configure Peripheral bus region 1 with [ASSIST_DEBUG_CORE_0_AREA_PIF_1_MIN_REG](#) and [ASSIST_DEBUG_CORE_0_AREA_PIF_1_MAX_REG](#).
 - Configure SP threshold with [ASSIST_DEBUG_CORE_0_SP_MIN_REG](#) and [ASSIST_DEBUG_CORE_0_SP_MAX_REG](#).
2. Configure interrupts.
 - Configure [ASSIST_DEBUG_CORE_0_INTR_ENA_REG](#) to enable the interrupt of a monitoring mode.

- Configure [ASSIST_DEBUG_CORE_0_INTR_RAW_REG](#) to get the interrupt status of a monitoring mode.
 - Configure [ASSIST_DEBUG_CORE_0_INTR_CLR_REG](#) to clear the interrupt of a monitoring mode.
3. Configure [ASSIST_DEBUG_CORE_0_MONTR_ENA_REG](#) to enable the monitoring mode(s). Various monitoring modes can be enabled at the same time.

Assuming that Debug Assistant module needs to monitor whether Data bus has written to [A ~ B] address space, the user can enable monitoring in either Data bus region 0 or region 1. The following configuration process is based on region 0:

1. Configure [ASSIST_DEBUG_CORE_0_RCD_PDEBUGEN](#) to 1 to enable HP CPU to update the PC signals to the Debug Assistant module.
2. Configure [ASSIST_DEBUG_CORE_0_AREA_DRAM0_0_MIN_REG](#) to Address A.
3. Configure [ASSIST_DEBUG_CORE_0_AREA_DRAM0_0_MAX_REG](#) to Address B.
4. Configure [ASSIST_DEBUG_CORE_0_INTR_ENA_REG](#) bit[1] to enable the interrupt for write operations by Data bus in region 0.
5. Configure [ASSIST_DEBUG_CORE_0_MONTR_ENA_REG](#) bit[1] to enable monitoring write operations by Data bus in region 0.
6. Configure interrupt matrix to map ASSIST_DEBUG_INT into HP CPU interrupt (please refer to Chapter 10 *Interrupt Matrix (INTMTX)*).
7. After the interrupt is triggered:
 - Read [ASSIST_DEBUG_CORE_0_INTR_RAW_REG](#) to learn which operation triggered the interrupt.
 - If the interrupt is triggered by region monitoring, read [ASSIST_DEBUG_CORE_0_AREA_PC_REG](#) for the PC value, and [ASSIST_DEBUG_CORE_0_AREA_SP_REG](#) for the SP.
 - If the interrupt is triggered by stack monitoring, read [ASSIST_DEBUG_CORE_0_SP_PC_REG](#) for the PC value.
 - Write 1 to the corresponding bits of [ASSIST_DEBUG_CORE_0_INTR_RAW_REG](#) to clear the interrupts.

17.4.2 PC Logging Configuration

Configure [ASSIST_DEBUG_CORE_0_RCD_PDEBUGEN](#) to 1 to enable HP CPU to update the PC signals to the Debug Assistant module. If [ASSIST_DEBUG_CORE_0_RCD_RECORDEN](#) is also configured to 1, [ASSIST_DEBUG_CORE_0_RCD_PDEBUGPC_REG](#) will record the HP CPU's PC signal and [ASSIST_DEBUG_CORE_0_RCD_PDEBUGSP_REG](#) will record the SP value. Otherwise, the two registers keep the original values.

When the CPU resets, [ASSIST_DEBUG_CORE_0_RCD_EN_REG](#) will reset, while [ASSIST_DEBUG_CORE_0_RCD_PDEBUGPC_REG](#) and [ASSIST_DEBUG_CORE_0_RCD_PDEBUGSP_REG](#) will not. Therefore, the two registers will keep the PC value and SP value at the CPU reset.

17.4.3 CPU/DMA Bus Access Logging Configuration

The configuration process for CPU/DMA bus access logging is described below.

1. Configure monitored address space.
 - Configure [MEM_MONITOR_LOG_MIN_REG](#) and [MEM_MONITOR_LOG_MAX_REG](#) to specify monitored address space.
2. Configure the monitoring mode with [MEM_MONITOR_LOG_MODE](#):
 - write monitoring (whether the bus has write operations)
 - word monitoring (whether the bus writes a specific word)
 - halfword monitoring (whether the bus writes a specific halfword)
 - byte monitoring (whether the bus writes a specific byte)
3. Configure the specific values to be monitored.
 - In word monitoring mode, [MEM_MONITOR_LOG_CHECK_DATA_REG](#) specifies the monitored word.
 - In halfword monitoring mode, [MEM_MONITOR_LOG_CHECK_DATA_REG](#)[15:0] specifies the monitored halfword.
 - In byte monitoring mode, [MEM_MONITOR_LOG_CHECK_DATA_REG](#)[7:0] specifies the monitored byte.
 - [MEM_MONITOR_LOG_DATA_MASK_REG](#) is used to mask the byte specified in [MEM_MONITOR_LOG_CHECK_DATA_REG](#). A masked byte can be any value. For example, in word monitoring, if [MEM_MONITOR_LOG_CHECK_DATA_REG](#) is configured to 0x01020304 and [MEM_MONITOR_LOG_DATA_MASK_REG](#) is configured to 0x1, then any writes of the data matching the 0x010203XX pattern by the bus will be recorded.
4. Configure the storage space for recorded data.
 - [MEM_MONITOR_LOG_MEM_START_REG](#) and [MEM_MONITOR_LOG_MEM_END_REG](#) specify the storage space for recorded data. The storage space must be in the range of 0x4080_0000 ~ 0x4087_FFFF.
 - Set [MEM_MONITOR_LOG_MEM_ADDR_UPDATE_REG](#) to update the value in [MEM_MONITOR_LOG_MEM_START_REG](#) to [MEM_MONITOR_LOG_MEM_CURRENT_ADDR_REG](#).
 - Configure the permission for the Debug Assistant module to access the internal HP SRAM. Only when the access permission is enabled can the Debug Assistant module access the internal HP SRAM. For more information, please refer to Chapter [15 Permission Control \(PMS\)](#).
5. Configure the writing mode for the recorded data: loop mode or non-loop mode.
 - In loop mode, writing to the specified address space is performed in loops. When writing reaches the end address, it will return to the starting address and continue, overwriting the previously recorded data. Set [MEM_MONITOR_LOG_MEM_LOOP_ENABLE](#) to enable loop mode. For example, there are 10 write operations (1 ~ 10) to address space 0 ~ 4 during bus access. After the 5th operation writes to address 4, the 6th operation will start writing from address 0. The 6th to 10th operations will overwrite the previous data written by the 1th to 5th operations.
 - In non-loop mode, when writing reaches the end address, it will stop at the end address and dump the remaining data, not overwriting the previously recorded data. Clear [MEM_MONITOR_LOG_MEM_LOOP_ENABLE](#) to use non-loop mode.

For example, there are 10 write operations (1 ~ 10) to address space 0 ~ 4 during bus access. After the 5th operation writes to address 4, the 6th to 10th write operations will stop at address 4 and will not be performed any more. Therefore, the address 0 ~ 4 stores the values written by the 1 ~ 5 operations and the values of the 6 ~ 10 operations are dumped.

6. Configure bus enable registers.

- Enable HP CPU, LP CPU, or DMA bus access logging with [MEM_MONITOR_LOG_ENA](#). They can be enabled at the same time.

The Debug Assistant module first writes the recorded data to an internal buffer, and then fetches the data from the buffer and writes it to the configured memory space. When the monitored behaviors are triggered continuously, the generated recording packets may fully occupy the buffer, making it unable to take any incoming packets. At this time, the module dumps these incoming packets and buffers a LOST packet instead before the buffer reaches its capacity. However, the bus type and the number of these dumped packets are unknown.

When bus access logging is finished, the recorded data can be read from memory for decoding. The recorded data is in four packet formats, namely HP CPU packet (corresponding to HP CPU Data bus), LP CPU packet (corresponding to LP CPU bus), DMA packet (corresponding to DMA bus), and LOST packet. The packet formats are shown in Table 17-1, 17-2, 17-3, and 17-4.

Table 17-1. HP CPU Packet Format

Bit[63:34]	Bit[33:32]	Bit[31:4]	Bit[3:2]	Bit[1:0]
pc_offset	anchored(2)	addr_offset	format	anchored(1)

Table 17-2. LP CPU Packet Format

Bit[31:4]	Bit[3:2]	Bit[1:0]
addr_offset	format	anchored(1)

Table 17-3. DMA Packet Format

Bit[31:9]	Bit[8:4]	Bit[3:2]	Bit[1:0]
addr_offset	dma_source	format	anchored(1)

Table 17-4. LOST Packet Format

Bit[31:4]	Bit[3:2]	Bit[1:0]
reserved	format	anchored(1)

It can be seen from the data packet formats that the HP CPU packet size is 64 bits, LP CPU packet 32 bits, DMA packet size 32 bits, and LOST packet 32 bits. These packets contain the following fields:

- **format** – the packet type. 0: HP CPU packet; 1: DMA packet; 2: LP CPU packet; 3: LOST packet.
- **pc_offset** - the offset of the PC register at the time of access. Actual PC = pc_offset + 0x4000_0000.
- **addr_offset** - the address offset of a write operation. Actual address = addr_offset + [MEM_MONITOR_LOG_MIN_REG](#).

- **dma_source** - the source of DMA access. Refer to Table 17-5. For more information on the values 16 ~ 31 in the table, please refer to 4 *GDMA Controller (GDMA)*.
- **anchored** - the location of the 32 bits in the data packet. 1 indicates the lower 32 bits. 2 indicates the higher 32 bits.

Table 17-5. DMA Access Source

Value	Source
0	HP CPU
1	LP CPU
2	reserved
3	SDIO_SLV
4	reserved
5	MEM_MONITOR
6	TRACE
7 ~ 15	reserved
16 ~ 31	See the peripherals corresponding to the values 0 ~ 15 in Chapter 4 <i>GDMA Controller (GDMA)</i> > Table 4-1 <i>Peripheral-to-Memory and Memory-to-Peripheral Data Transfer</i> . For example, the source corresponding to the value 16 is the peripheral corresponding to the value 0 in that table, the source corresponding to 17 is the peripheral corresponding to 1 in that table, and etc.

The internal buffer of the module is 32 bits wide. When the HP CPU, LP CPU, or DMA bus access logging are all enabled at the same time and the record data is generated at the same time, the DMA data packets are first buffered, then the HP CPU packets, and finally the LP CPU packets. This priority of buffering packets also applies to the case where only two types of packets are generated at the same time. The Debug Assistant will automatically fetch the buffered data and store it in 32-bit data width into the specified memory space.

In loop mode, data looping several times in the storage memory may cause residual data, which can interfere with packet parsing. For example, the lower 32 bits of a HP CPU packet are overwritten, thus making its higher 32 bits residual data. Therefore, users need to filter out the possible residual data in order to determine the starting position of the first valid packet with `MEM_MONITOR_LOG_MEM_CURRENT_ADDR_REG`. Once the starting position of the packet is identified, check the anchored bit value of the packet. If it is 1, the data will be retained. If it is 2, it will be dumped.

The process of packet parsing is described below:

- Determine whether there is a data overflow with `MEM_MONITOR_LOG_MEM_FULL_FLAG`. If no, the address space to read is `MEM_MONITOR_LOG_MEM_START_REG ~ MEM_MONITOR_LOG_MEM_CURRENT_ADDR_REG - 4`. If yes and the loop mode is enabled, the address space is `MEM_MONITOR_LOG_MEM_CURRENT_ADDR_REG ~ MEM_MONITOR_LOG_MEM_END_REG` and `MEM_MONITOR_LOG_MEM_START_REG ~ MEM_MONITOR_LOG_MEM_CURRENT_ADDR_REG - 4`. If yes and loop mode is not enabled, the address space is `MEM_MONITOR_LOG_MEM_START_REG ~ MEM_MONITOR_LOG_MEM_END_REG`.

- Read and parse data from the starting address. Read 32 bits each time.

After packet parsing is completed, clear the [MEM_MONITOR_LOG_MEM_FULL_FLAG](#) flag bit by setting [MEM_MONITOR_CLR_LOG_MEM_FULL_FLAG](#).

17.5 Register Summary

The addresses of **bus logging configuration registers** (see 17.5.1) in this section are relative to the **MEM_MONITOR** base address. The addresses of other registers (see 17.5.2) are relative to the **ASSIST_DEBUG** base address. Both base addresses are provided in Table 5-2 in Chapter 5 *System and Memory*.

The abbreviations given in Column **Access** are explained in Section *Access Types for Registers*.

17.5.1 Summary of Bus Logging Configuration Registers

Name	Description	Address	Access
Bus access logging configuration registers			
MEM_MONITOR_LOG_SETTING_REG	Bus access logging configuration register	0x0000	R/W
MEM_MONITOR_LOG_CHECK_DATA_REG	Configures monitored data in Bus access logging	0x0004	R/W
MEM_MONITOR_LOG_DATA_MASK_REG	Configures masked data in Bus access logging	0x0008	R/W
MEM_MONITOR_LOG_MIN_REG	Configures monitored address space in Bus access logging	0x000C	R/W
MEM_MONITOR_LOG_MAX_REG	Configures monitored address space in Bus access logging	0x0010	R/W
MEM_MONITOR_LOG_MEM_START_REG	Configures the starting address of the storage memory for recorded data	0x0014	R/W
MEM_MONITOR_LOG_MEM_END_REG	Configures the end address of the storage memory for recorded data	0x0018	R/W
MEM_MONITOR_LOG_MEM_CURRENT_ADDR_REG	Represents the address for the next write	0x001C	RO
MEM_MONITOR_LOG_MEM_ADDR_UPDATE_REG	Updates the address for the next write with the starting address for the recorded data	0x0020	R/W
MEM_MONITOR_LOG_MEM_FULL_FLAG_REG	Logging overflow status register	0x0024	varies
Clock control register			
MEM_MONITOR_CLOCK_GATE_REG	Register clock control	0x0028	R/W
Version control register			
MEM_MONITOR_DATE_REG	Version control register	0x03FC	R/W

17.5.2 Summary of Other Registers

Name	Description	Address	Access
Monitor configuration registers			
ASSIST_DEBUG_CORE_0_MONTR_ENA_REG	Monitoring enable register	0x0000	R/W

Name	Description	Address	Access
ASSIST_DEBUG_CORE_0_AREA_DRAM0_0_MIN_REG	Configures lower boundary address of region 0 monitored on Data bus	0x0010	R/W
ASSIST_DEBUG_CORE_0_AREA_DRAM0_0_MAX_REG	Configures upper boundary address of region 0 monitored on Data bus	0x0014	R/W
ASSIST_DEBUG_CORE_0_AREA_DRAM0_1_MIN_REG	Configures lower boundary address of region 1 monitored on Data bus	0x0018	R/W
ASSIST_DEBUG_CORE_0_AREA_DRAM0_1_MAX_REG	Configures upper boundary address of region 1 monitored on Data bus	0x001C	R/W
ASSIST_DEBUG_CORE_0_AREA_PIF_0_MIN_REG	Configures lower boundary address of region 0 monitored on Peripheral bus	0x0020	R/W
ASSIST_DEBUG_CORE_0_AREA_PIF_0_MAX_REG	Configures upper boundary address of region 0 monitored on Peripheral bus	0x0024	R/W
ASSIST_DEBUG_CORE_0_AREA_PIF_1_MIN_REG	Configures lower boundary address of region 1 monitored on Peripheral bus	0x0028	R/W
ASSIST_DEBUG_CORE_0_AREA_PIF_1_MAX_REG	Configures upper boundary address of region 1 monitored on Peripheral bus	0x002C	R/W
ASSIST_DEBUG_CORE_0_AREA_PC_REG	Region monitoring HP CPU PC status register	0x0030	RO
ASSIST_DEBUG_CORE_0_AREA_SP_REG	Region monitoring HP CPU SP status register	0x0034	RO
ASSIST_DEBUG_CORE_0_SP_MIN_REG	Configures stack monitoring lower boundary address	0x0038	R/W
ASSIST_DEBUG_CORE_0_SP_MAX_REG	Configures stack monitoring upper boundary address	0x003C	R/W
ASSIST_DEBUG_CORE_0_SP_PC_REG	Stack monitoring HP CPU PC status register	0x0040	RO
Interrupt configuration registers			
ASSIST_DEBUG_CORE_0_INTR_RAW_REG	Interrupt status register	0x0004	RO
ASSIST_DEBUG_CORE_0_INTR_ENA_REG	Interrupt enable register	0x0008	R/W
ASSIST_DEBUG_CORE_0_INTR_CLR_REG	Interrupt clear register	0x000C	R/W

Name	Description	Address	Access
PC logging configuration register			
ASSIST_DEBUG_CORE_0_RCD_EN_REG	HP CPU PC logging enable register	0x0044	R/W
PC logging status registers			
ASSIST_DEBUG_CORE_0_RCD_PDEBUGPC_REG	PC logging register	0x0048	RO
ASSIST_DEBUG_CORE_0_RCD_PDEBUGSP_REG	PC logging register	0x004C	RO
CPU status registers			
ASSIST_DEBUG_CORE_0_LASTPC_BEFORE_EXCEPTION_REG	PC of the last command before HP CPU enters exception	0x0070	RO
ASSIST_DEBUG_CORE_0_DEBUG_MODE_REG	HP CPU debug mode status register	0x0074	RO
Clock control register			
ASSIST_DEBUG_CLOCK_GATE_REG	Register clock control	0x0078	R/W
Version register			
ASSIST_DEBUG_DATE_REG	Version control register	0x03FC	R/W

17.6 Registers

The addresses of **bus logging configuration registers** (see [17.6.1](#)) in this section are relative to **MEM_MONITOR** base address. The addresses of other registers (see [17.6.2](#)) are relative to the **ASSIST_DEBUG** base address. Both base addresses are provided in Table [5-2](#) in Chapter [5 System and Memory](#).

17.6.1 Bus Logging Configuration Registers

Register 17.1. MEM_MONITOR_LOG_SETTING_REG (0x0000)

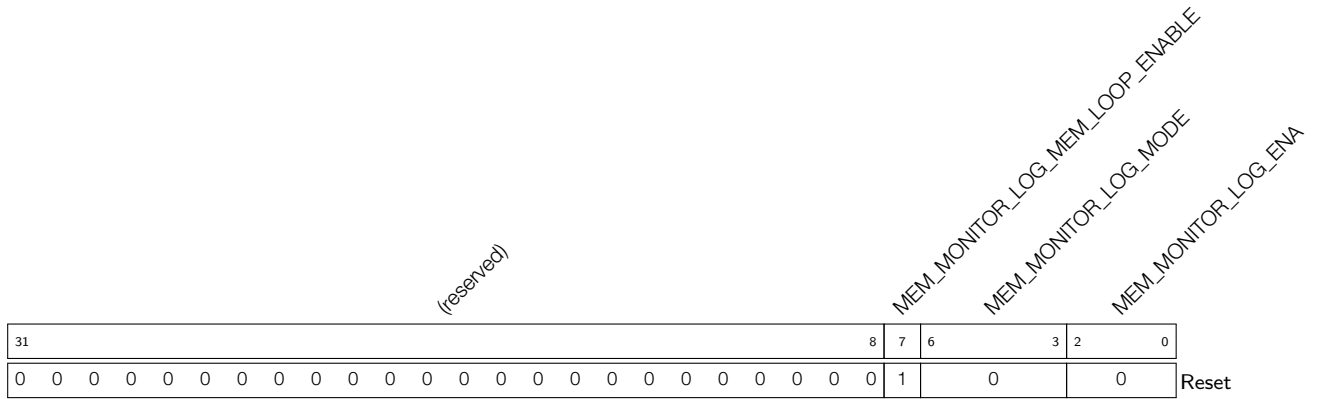

MEM_MONITOR_LOG_ENA Configures whether to enable CPU or DMA bus access logging.

bit[0]: Configures whether to enable HP CPU bus access logging.

0: Disable

1: Enable

bit[1]: Configures whether to enable LP CPU bus access logging.

0: Disable

1: Enable

bit[2]: Configures whether to enable DMA bus access logging.

0: Disable

1: Enable

(R/W)

MEM_MONITOR_LOG_MODE Configures monitoring modes.

bit[0]: Configures write monitoring.

0: Disable

1: Enable

bit[1]: Configures word monitoring.

0: Disable

1: Enable

bit[2]: Configures halfword monitoring.

0: Disable

1: Enable

bit[3]: Configures byte monitoring.

0: Disable

1: Enable

(R/W)

MEM_MONITOR_LOG_MEM_LOOP_ENABLE Configures the writing mode for recorded data.

1: Loop mode

0: Non-loop mode

(R/W)

Register 17.2. MEM_MONITOR_LOG_CHECK_DATA_REG (0x0004)

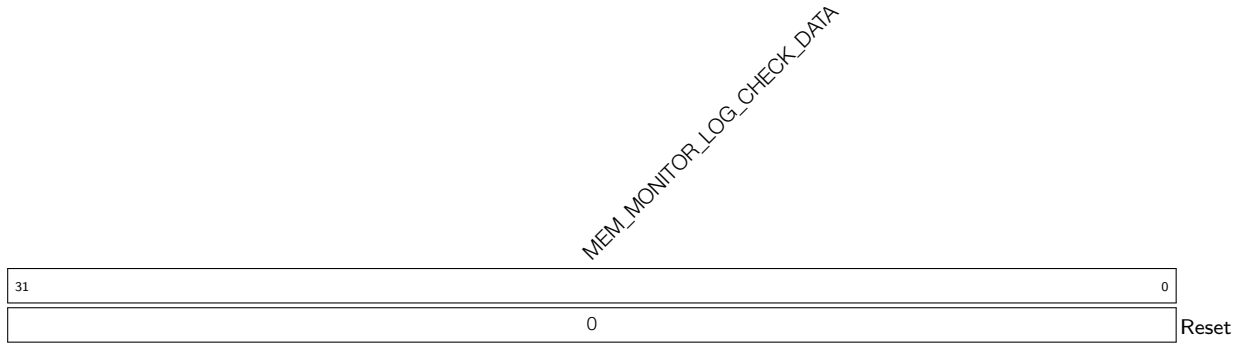

MEM_MONITOR_LOG_CHECK_DATA Configures the data to be monitored during bus accessing.
(R/W)

Register 17.3. MEM_MONITOR_LOG_DATA_MASK_REG (0x0008)

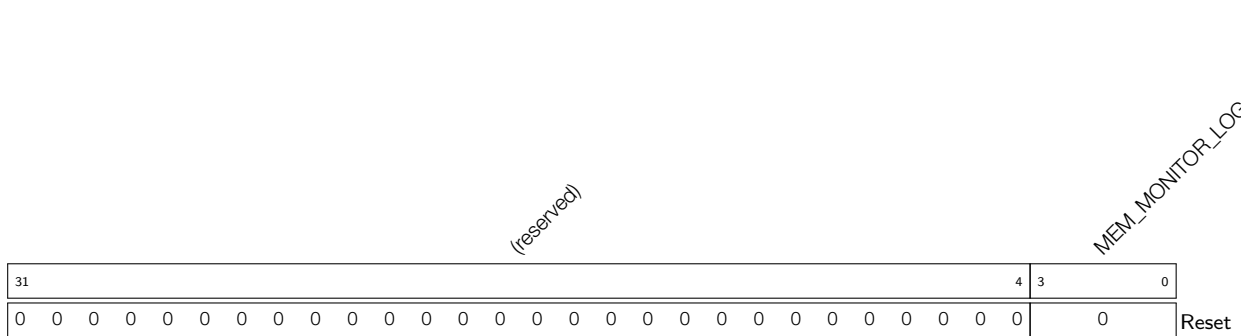

MEM_MONITOR_LOG_DATA_MASK Configures which byte(s) in [MEM_MONITOR_LOG_CHECK_DATA_REG](#) to mask.

bit[0]: Configures whether to mask the least significant byte of [MEM_MONITOR_LOG_CHECK_DATA_REG](#).
0: Not mask
1: Mask

bit[1]: Configures whether to mask the second least significant byte of [MEM_MONITOR_LOG_CHECK_DATA_REG](#).
0: Not mask
1: Mask

bit[2]: Configures whether to mask the second most significant byte of [MEM_MONITOR_LOG_CHECK_DATA_REG](#).
0: Not mask
1: Mask

bit[3]: Configures whether to mask the most significant byte of [MEM_MONITOR_LOG_CHECK_DATA_REG](#).
0: Not mask
1: Mask

(R/W)

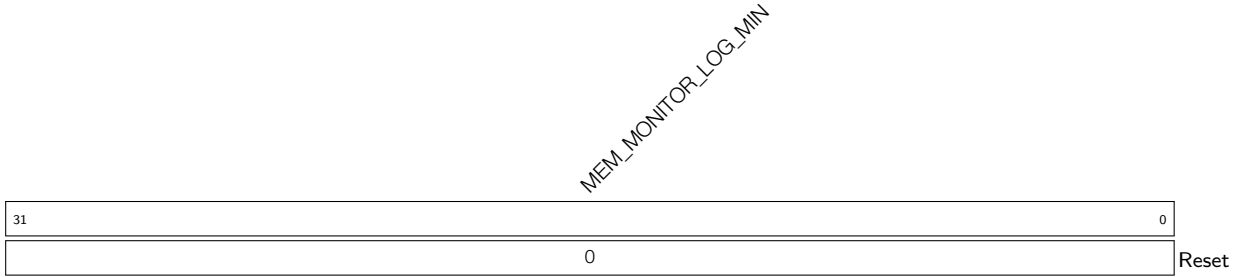
Register 17.4. MEM_MONITOR_LOG_MIN_REG (0x000C)

MEM_MONITOR_LOG_MIN Configures the lower bound address of the monitored address space.
(R/W)

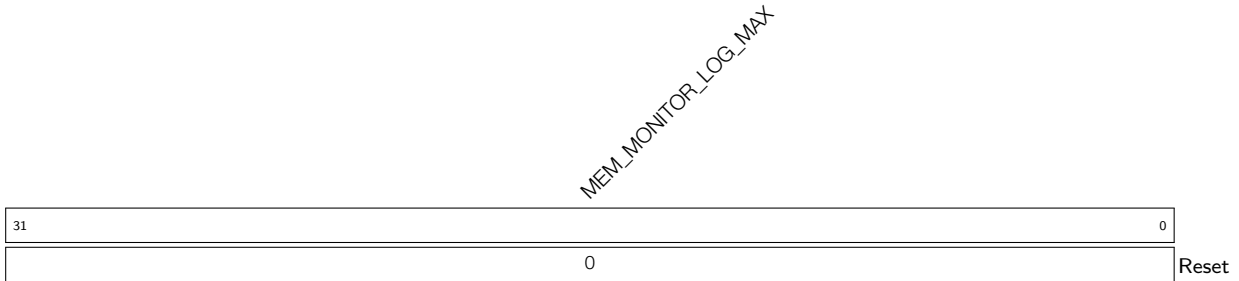
Register 17.5. MEM_MONITOR_LOG_MAX_REG (0x0010)

MEM_MONITOR_LOG_MAX Configures the upper bound address of the monitored address space.
(R/W)

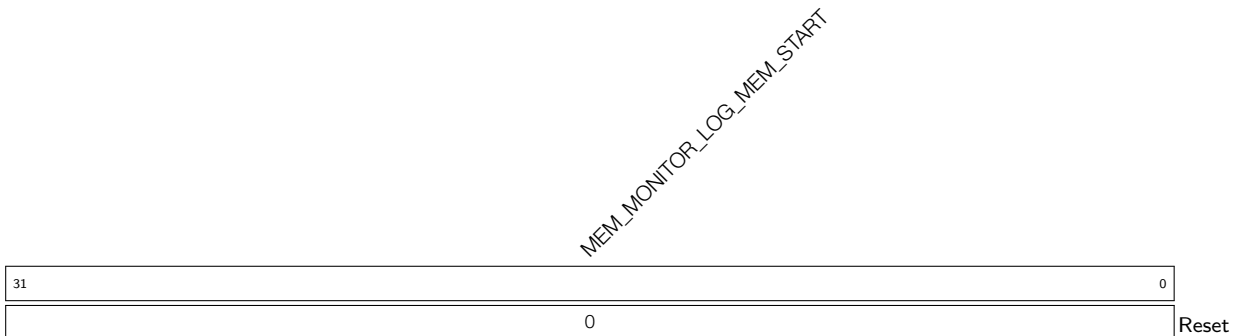
Register 17.6. MEM_MONITOR_LOG_MEM_START_REG (0x0014)

MEM_MONITOR_LOG_MEM_START Configures the starting address of the storage space for recorded data. (R/W)

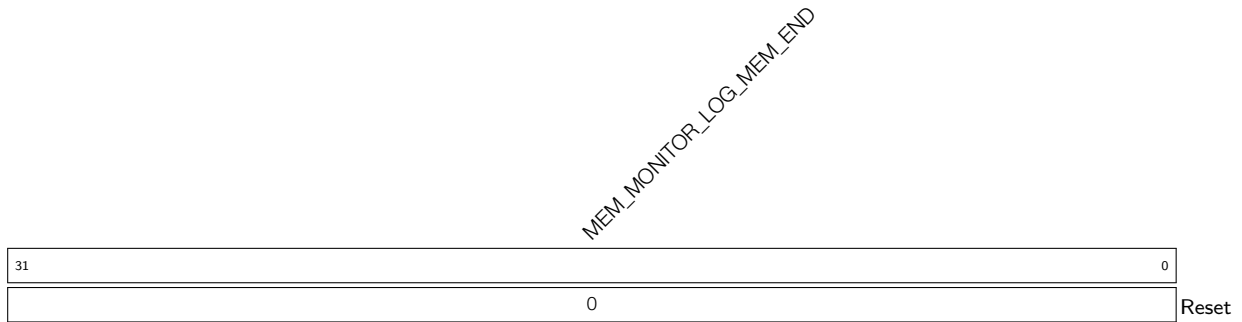
Register 17.7. MEM_MONITOR_LOG_MEM_END_REG (0x0018)

MEM_MONITOR_LOG_MEM_END Configures the ending address of the storage space for recorded data. (R/W)

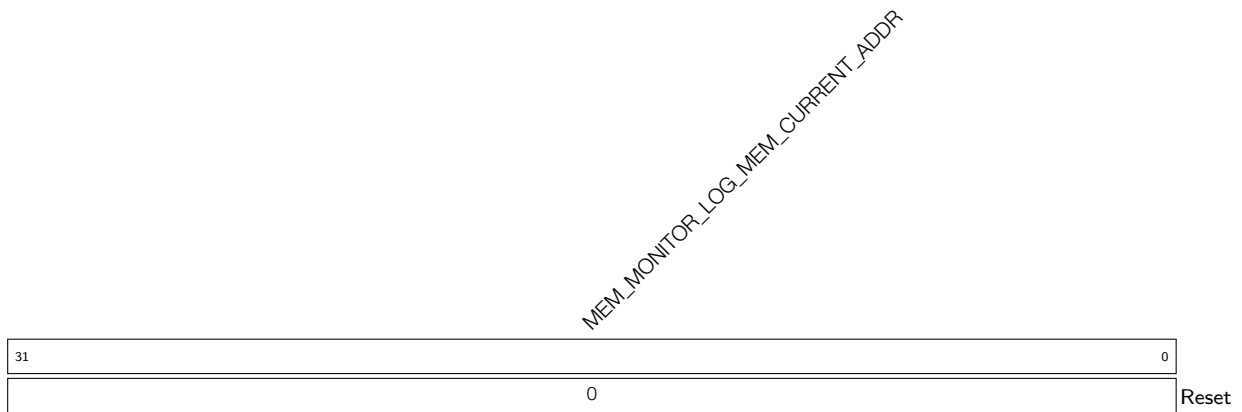
Register 17.8. MEM_MONITOR_LOG_MEM_CURRENT_ADDR_REG (0x001C)

MEM_MONITOR_LOG_MEM_CURRENT_ADDR Represents the address of the next write. (RO)

Register 17.9. MEM_MONITOR_LOG_MEM_ADDR_UPDATE_REG (0x0020)

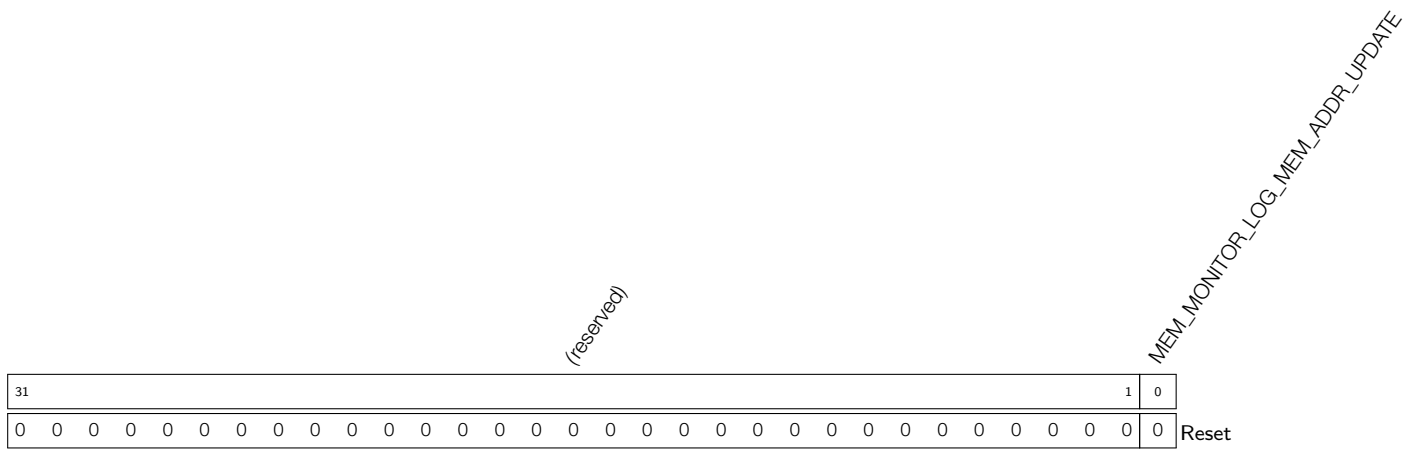

MEM_MONITOR_LOG_MEM_ADDR_UPDATE Configures whether to update the value in [MEM_MONITOR_LOG_MEM_START_REG](#) to [MEM_MONITOR_LOG_MEM_CURRENT_ADDR_REG](#).

1: Update
 0: Not update (default)
 (R/W)

Register 17.10. MEM_MONITOR_LOG_MEM_FULL_FLAG_REG (0x0024)

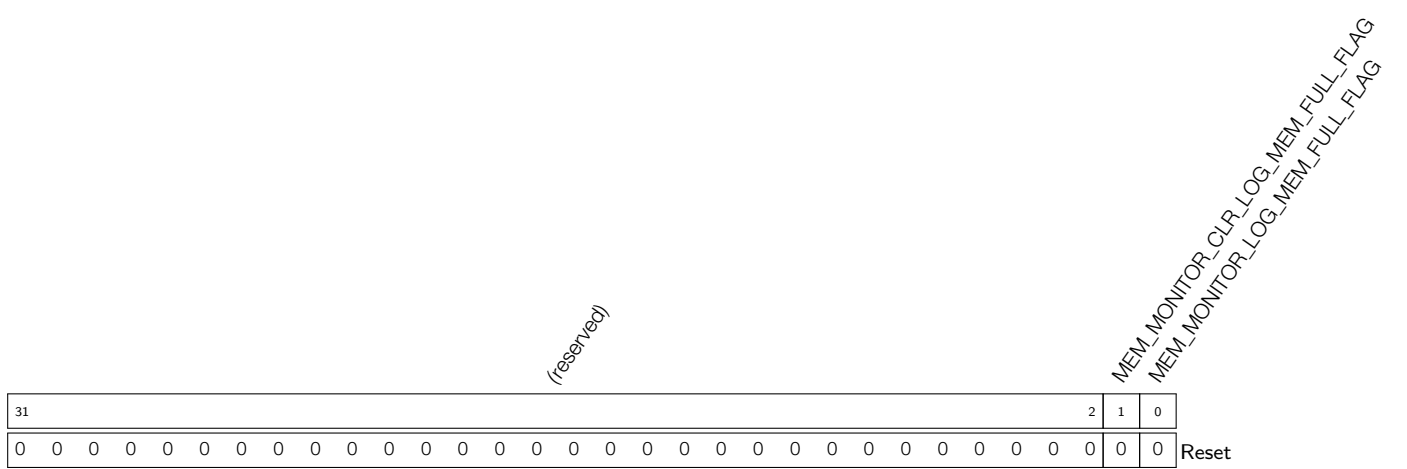

MEM_MONITOR_LOG_MEM_FULL_FLAG Represents whether data overflows the storage space

0: Not Overflow
 1: Overflow
 (RO)

MEM_MONITOR_CLR_LOG_MEM_FULL_FLAG Configures whether to clear the [MEM_MONITOR_LOG_MEM_FULL_FLAG](#) flag bit.

0: Not clear
 1: Clear
 (R/W)

Register 17.11. MEM_MONITOR_CLOCK_GATE_REG (0x0028)

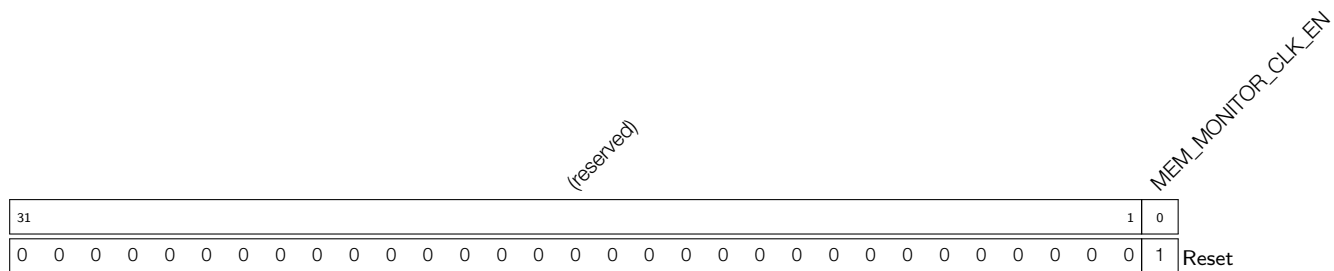

MEM_MONITOR_CLK_EN Configures whether to enable the register clock gating.

0: Disable

1: Enable

(R/W)

Register 17.12. MEM_MONITOR_DATE_REG (0x03FC)

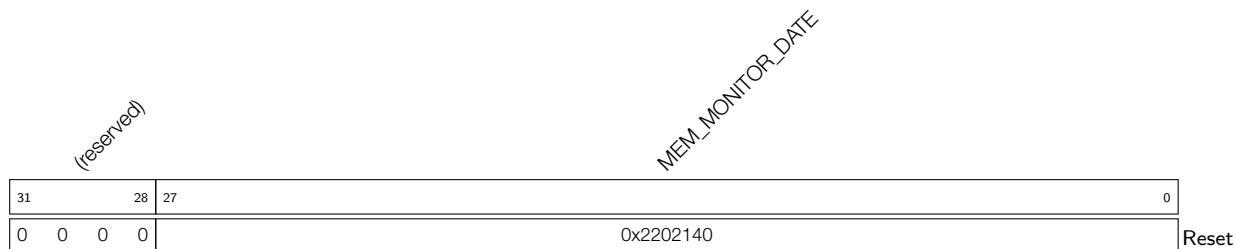

MEM_MONITOR_DATE Version control register. (R/W)

Register 17.13. ASSIST_DEBUG_CORE_0_MONTR_ENA_REG (0x0000)

Continued from the previous page...

ASSIST_DEBUG_CORE_0_AREA_PIF_0_WR_ENA Configures whether to monitor write operations in region 0 by the Peripheral bus.

0: Not Monitor

1: Monitor

(R/W)

ASSIST_DEBUG_CORE_0_AREA_PIF_1_RD_ENA Configures whether to monitor read operations in region 1 by the Peripheral bus.

0: Not Monitor

1: Monitor

(R/W)

ASSIST_DEBUG_CORE_0_AREA_PIF_1_WR_ENA Configures whether to monitor write operations in region 1 by the Peripheral bus.

0: Not Monitor

1: Monitor

(R/W)

ASSIST_DEBUG_CORE_0_SP_SPILL_MIN_ENA Configures whether to monitor SP exceeding the lower bound address of SP monitored region.

0: Not Monitor

1: Monitor

(R/W)

ASSIST_DEBUG_CORE_0_SP_SPILL_MAX_ENA Configures whether to monitor SP exceeding the upper bound address of SP monitored region.

0: Not Monitor

1: Monitor

(R/W)

Register 17.14. ASSIST_DEBUG_CORE_0_AREA_DRAM0_0_MIN_REG (0x0010)

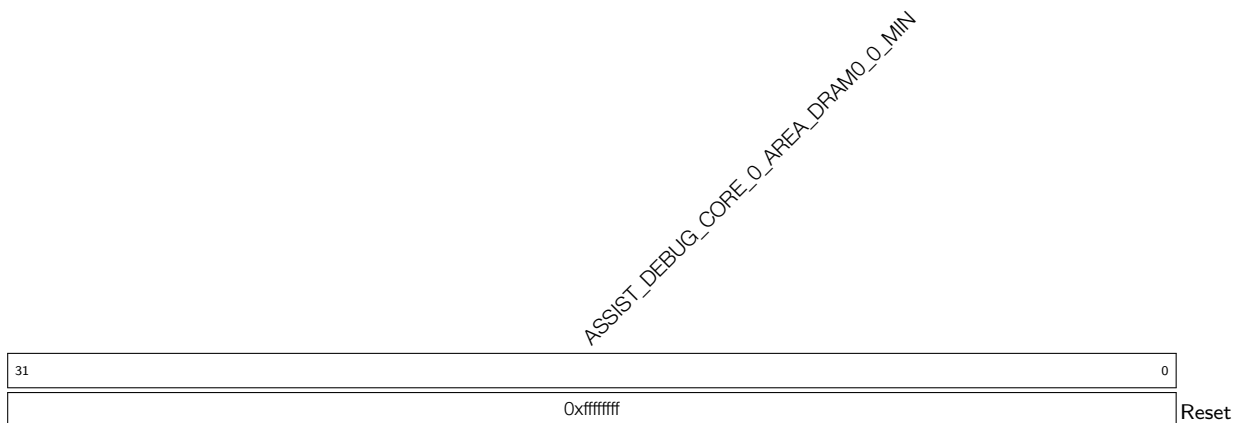

ASSIST_DEBUG_CORE_0_AREA_DRAM0_0_MIN Configures the lower bound address of Data bus region 0. (R/W)

Register 17.15. ASSIST_DEBUG_CORE_0_AREA_DRAM0_0_MAX_REG (0x0014)

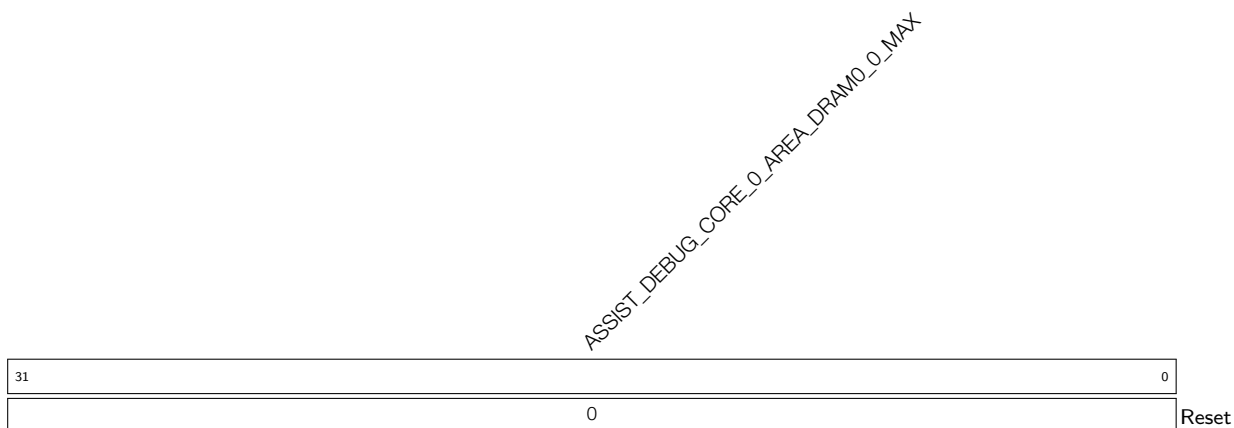

ASSIST_DEBUG_CORE_0_AREA_DRAM0_0_MAX Configures the upper bound address of Data bus region 0. (R/W)

Register 17.16. ASSIST_DEBUG_CORE_0_AREA_DRAM0_1_MIN_REG (0x0018)

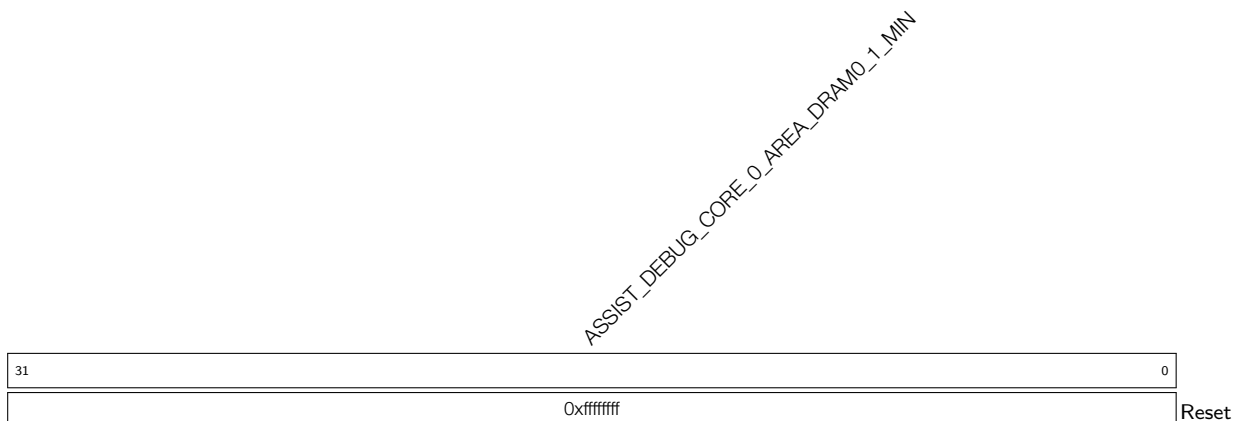

ASSIST_DEBUG_CORE_0_AREA_DRAM0_1_MIN Configures the lower bound address of Data bus region 1. (R/W)

Register 17.17. ASSIST_DEBUG_CORE_0_AREA_DRAM0_1_MAX_REG (0x001C)

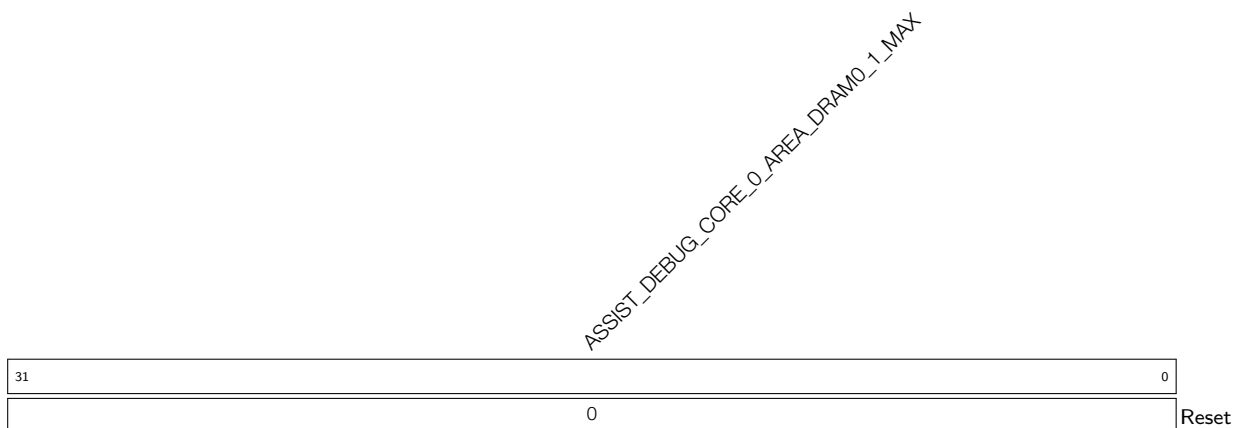

ASSIST_DEBUG_CORE_0_AREA_DRAM0_1_MAX Configures the upper bound address of Data bus region 1. (R/W)

Register 17.18. ASSIST_DEBUG_CORE_0_AREA_PIF_0_MIN_REG (0x0020)



ASSIST_DEBUG_CORE_0_AREA_PIF_0_MIN Configures the lower bound address of Peripheral bus region 0. (R/W)

Register 17.19. ASSIST_DEBUG_CORE_0_AREA_PIF_0_MAX_REG (0x0024)

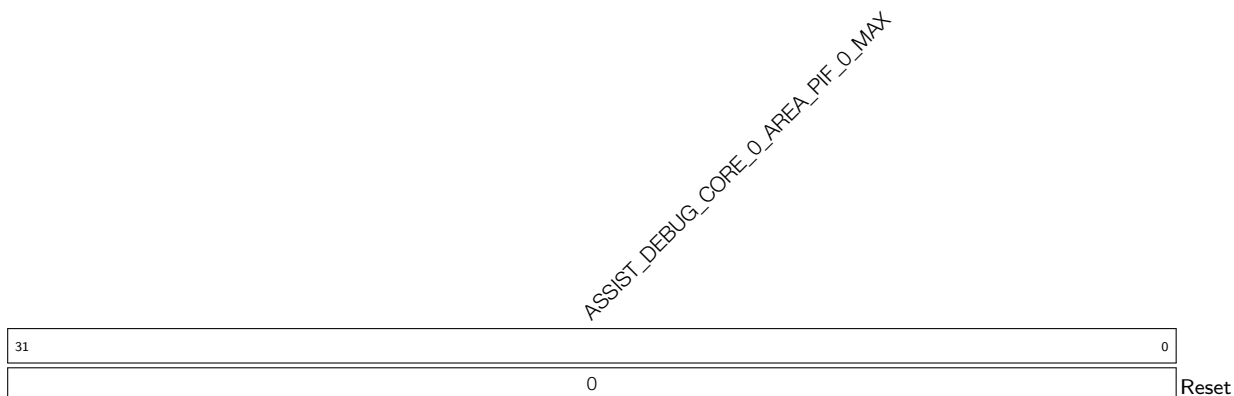

ASSIST_DEBUG_CORE_0_AREA_PIF_0_MAX Configures the upper bound address of Peripheral bus region 0. (R/W)

Register 17.20. ASSIST_DEBUG_CORE_0_AREA_PIF_1_MIN_REG (0x0028)

ASSIST_DEBUG_CORE_0_AREA_PIF_1_MIN Configures the lower bound address of Peripheral bus region 1. (R/W)

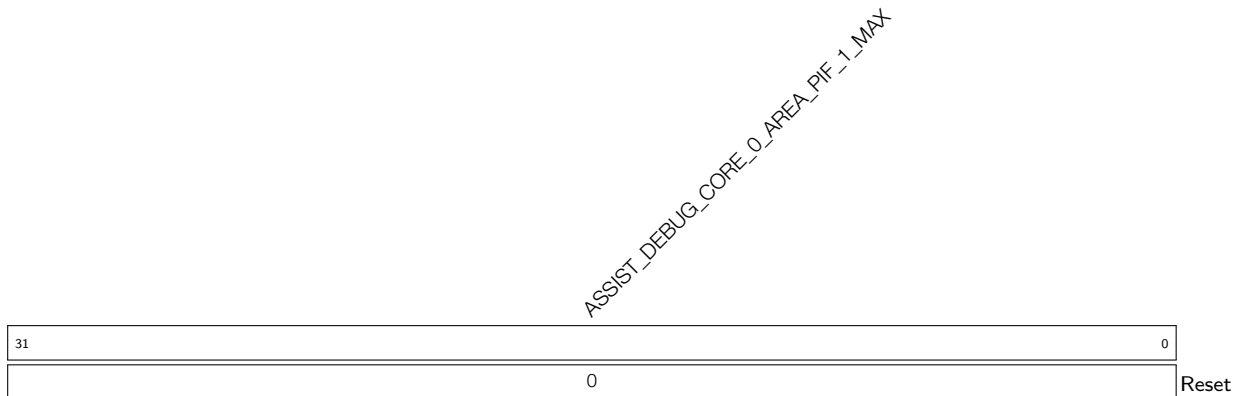
Register 17.21. ASSIST_DEBUG_CORE_0_AREA_PIF_1_MAX_REG (0x002C)

ASSIST_DEBUG_CORE_0_AREA_PIF_1_MAX Configures the upper bound address of Peripheral bus region 1. (R/W)

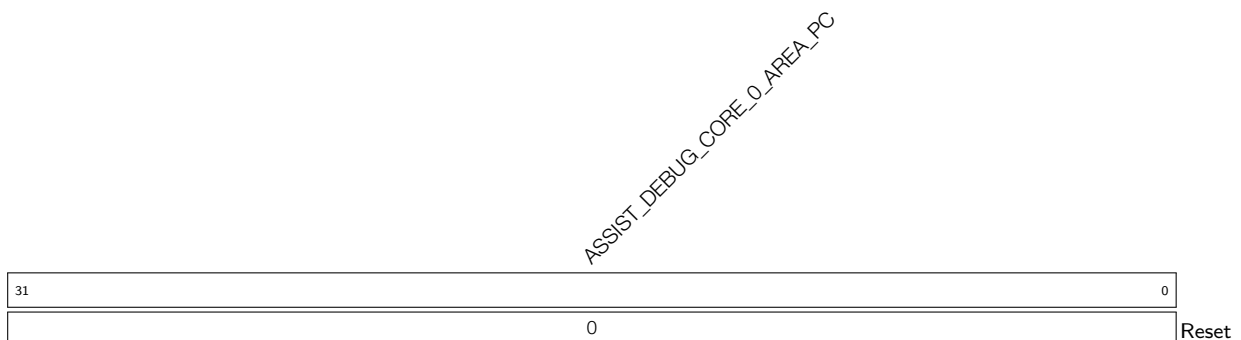
Register 17.22. ASSIST_DEBUG_CORE_0_AREA_PC_REG (0x0030)

ASSIST_DEBUG_CORE_0_AREA_PC Represents the PC value when an interrupt is triggered during region monitoring. (RO)

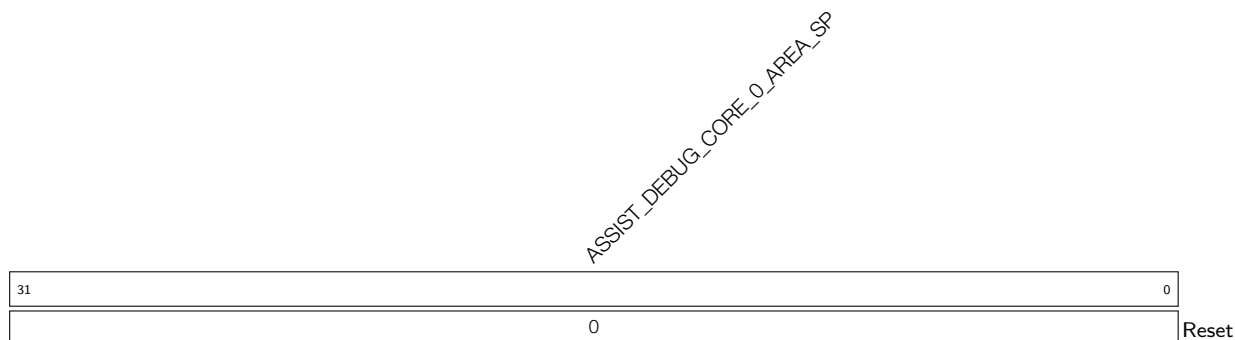
Register 17.23. ASSIST_DEBUG_CORE_0_AREA_SP_REG (0x0034)

ASSIST_DEBUG_CORE_0_AREA_SP Represents the SP value when an interrupt is triggered during region monitoring. (RO)

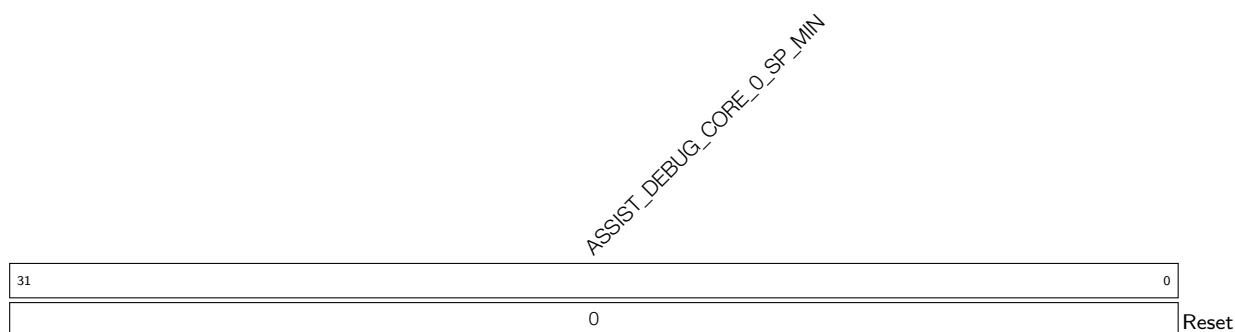
Register 17.24. ASSIST_DEBUG_CORE_0_SP_MIN_REG (0x0038)

ASSIST_DEBUG_CORE_0_SP_MIN Configures the lower bound address of SP. (R/W)

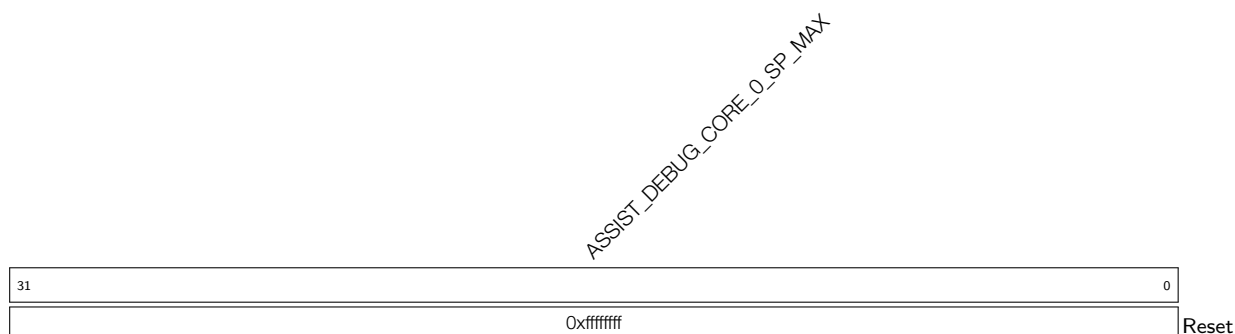
Register 17.25. ASSIST_DEBUG_CORE_0_SP_MAX_REG (0x003C)

ASSIST_DEBUG_CORE_0_SP_MAX Configures the upper bound address of SP. (R/W)

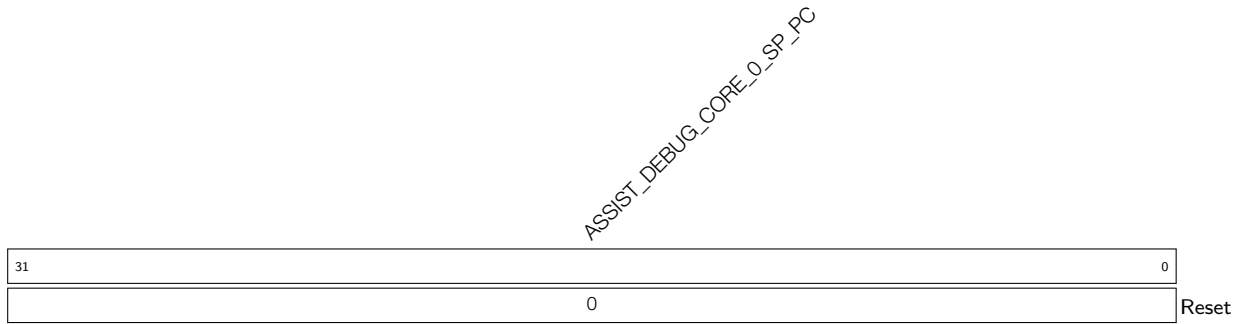
Register 17.26. ASSIST_DEBUG_CORE_0_SP_PC_REG (0x0040)

ASSIST_DEBUG_CORE_0_SP_PC Represents the PC value during stack monitoring. (RO)

Register 17.27. ASSIST_DEBUG_CORE_0_INTR_RAW_REG (0x0004)

(reserved)										ASSIST_DEBUG_CORE_0_SP_SPILL_MAX_RAW ASSIST_DEBUG_CORE_0_SP_SPILL_MIN_RAW ASSIST_DEBUG_CORE_0_AREA_PIF_1_WR_RAW ASSIST_DEBUG_CORE_0_AREA_PIF_1_RD_RAW ASSIST_DEBUG_CORE_0_AREA_PIF_0_WR_RAW ASSIST_DEBUG_CORE_0_AREA_PIF_0_RD_RAW ASSIST_DEBUG_CORE_0_AREA_DRAM0_1_WR_RAW ASSIST_DEBUG_CORE_0_AREA_DRAM0_1_RD_RAW ASSIST_DEBUG_CORE_0_AREA_DRAM0_0_WR_RAW ASSIST_DEBUG_CORE_0_AREA_DRAM0_0_RD_RAW										
31										10	9	8	7	6	5	4	3	2	1	0
0 0 0 0 0 0 0 0 0 0										0 0 0 0 0 0 0 0 0 0										Reset

- ASSIST_DEBUG_CORE_0_AREA_DRAM0_0_RD_RAW** The raw interrupt status of read operations in region 0 by Data bus. (RO)
- ASSIST_DEBUG_CORE_0_AREA_DRAM0_0_WR_RAW** The raw interrupt status of write operations in region 0 by Data bus. (RO)
- ASSIST_DEBUG_CORE_0_AREA_DRAM0_1_RD_RAW** The raw interrupt status of read operations in region 1 by Data bus. (RO)
- ASSIST_DEBUG_CORE_0_AREA_DRAM0_1_WR_RAW** The raw interrupt status of write operations in region 1 by Data bus. (RO)
- ASSIST_DEBUG_CORE_0_AREA_PIF_0_RD_RAW** The raw interrupt status of read operations in region 0 by Peripheral bus. (RO)
- ASSIST_DEBUG_CORE_0_AREA_PIF_0_WR_RAW** The raw interrupt status of write operations in region 0 by Peripheral bus. (RO)
- ASSIST_DEBUG_CORE_0_AREA_PIF_1_RD_RAW** The raw interrupt status of read operations in region 1 by Peripheral bus. (RO)
- ASSIST_DEBUG_CORE_0_AREA_PIF_1_WR_RAW** The raw interrupt status of write operations in region 1 by Peripheral bus. (RO)
- ASSIST_DEBUG_CORE_0_SP_SPILL_MIN_RAW** The raw interrupt status of SP exceeding the lower bound address of SP monitored region. (RO)
- ASSIST_DEBUG_CORE_0_SP_SPILL_MAX_RAW** The raw interrupt status of SP exceeding the upper bound address of SP monitored region. (RO)

Register 17.28. ASSIST_DEBUG_CORE_0_INTR_ENA_REG (0x0008)

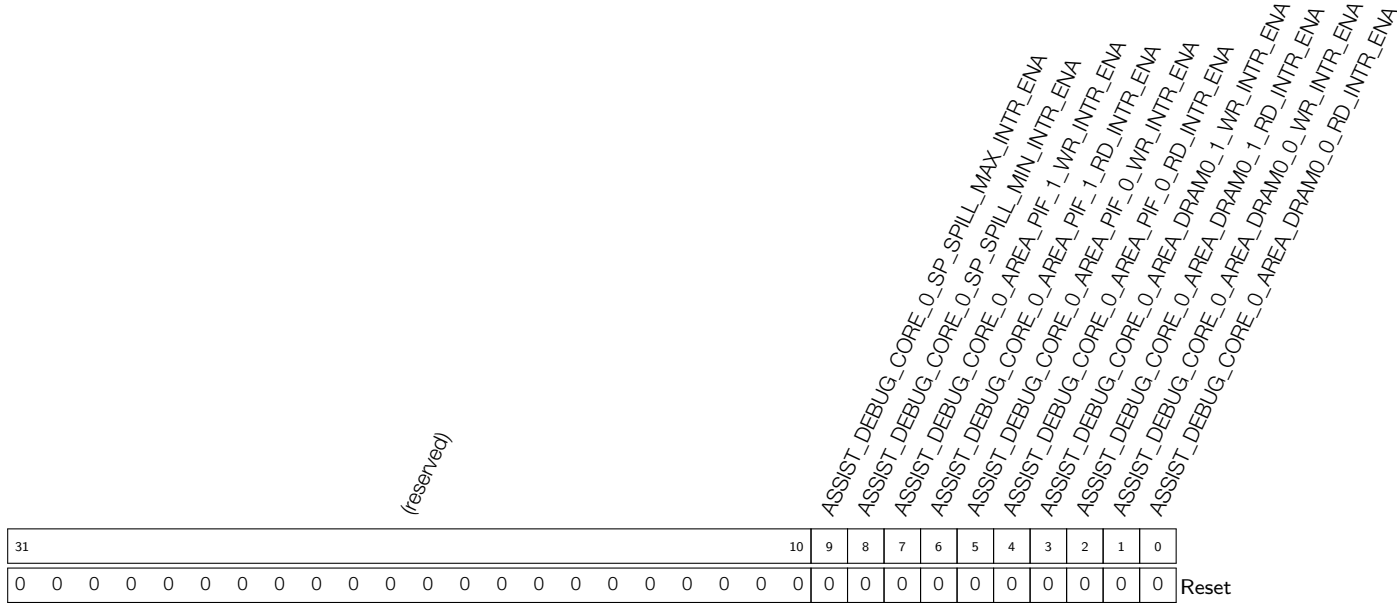

- ASSIST_DEBUG_CORE_0_AREA_DRAM0_0_RD_INTR_ENA** Write 1 to enable the interrupt for read operations in region 0 by Data bus. (R/W)
- ASSIST_DEBUG_CORE_0_AREA_DRAM0_0_WR_INTR_ENA** Write 1 to enable the interrupt for write operations in region 0 by Data bus. (R/W)
- ASSIST_DEBUG_CORE_0_AREA_DRAM0_1_RD_INTR_ENA** Write 1 to enable the interrupt for read operations in region 1 by Data bus. (R/W)
- ASSIST_DEBUG_CORE_0_AREA_DRAM0_1_WR_INTR_ENA** Write 1 to enable the interrupt for write operations in region 1 by Data bus. (R/W)
- ASSIST_DEBUG_CORE_0_AREA_PIF_0_RD_INTR_ENA** Write 1 to enable the interrupt for read operations in region 0 by Peripheral bus. (R/W)
- ASSIST_DEBUG_CORE_0_AREA_PIF_0_WR_INTR_ENA** Write 1 to enable the interrupt for write operations in region 0 by Peripheral bus. (R/W)
- ASSIST_DEBUG_CORE_0_AREA_PIF_1_RD_INTR_ENA** Write 1 to enable the interrupt for read operations in region 1 by Peripheral bus. (R/W)
- ASSIST_DEBUG_CORE_0_AREA_PIF_1_WR_INTR_ENA** Write 1 to enable the interrupt for write operations in region 1 by Peripheral bus. (R/W)
- ASSIST_DEBUG_CORE_0_SP_SPILL_MIN_INTR_ENA** Write 1 to enable the interrupt for SP exceeding the lower bound address of SP monitored region. (R/W)
- ASSIST_DEBUG_CORE_0_SP_SPILL_MAX_INTR_ENA** Write 1 to enable the interrupt for SP exceeding the upper bound address of SP monitored region. (R/W)

Register 17.29. ASSIST_DEBUG_CORE_0_INTR_CLR_REG (0x000C)

(reserved)										ASSIST_DEBUG_CORE_0_SP_SPILL_MAX_CLR ASSIST_DEBUG_CORE_0_SP_SPILL_MIN_CLR ASSIST_DEBUG_CORE_0_AREA_PIF_0_WR_CLR ASSIST_DEBUG_CORE_0_AREA_PIF_0_RD_CLR ASSIST_DEBUG_CORE_0_AREA_PIF_1_WR_CLR ASSIST_DEBUG_CORE_0_AREA_PIF_1_RD_CLR ASSIST_DEBUG_CORE_0_AREA_DRAM0_0_WR_CLR ASSIST_DEBUG_CORE_0_AREA_DRAM0_0_RD_CLR ASSIST_DEBUG_CORE_0_AREA_DRAM0_1_WR_CLR ASSIST_DEBUG_CORE_0_AREA_DRAM0_1_RD_CLR										
31										10	9	8	7	6	5	4	3	2	1	0
0										0										Reset

- ASSIST_DEBUG_CORE_0_AREA_DRAM0_0_RD_CLR** Write 1 to clear the interrupt for read operations in region 0 by Data bus. (R/W)
- ASSIST_DEBUG_CORE_0_AREA_DRAM0_0_WR_CLR** Write 1 to clear the interrupt for write operations in region 0 by Data bus. (R/W)
- ASSIST_DEBUG_CORE_0_AREA_DRAM0_1_RD_CLR** Write 1 to clear the interrupt for read operations in region 1 by Data bus. (R/W)
- ASSIST_DEBUG_CORE_0_AREA_DRAM0_1_WR_CLR** Write 1 to clear the interrupt for write operations in region 1 by Data bus. (R/W)
- ASSIST_DEBUG_CORE_0_AREA_PIF_0_RD_CLR** Write 1 to clear the interrupt for read operations in region 0 by Peripheral bus. (R/W)
- ASSIST_DEBUG_CORE_0_AREA_PIF_0_WR_CLR** Write 1 to clear the interrupt for write operations in region 0 by Peripheral bus. (R/W)
- ASSIST_DEBUG_CORE_0_AREA_PIF_1_RD_CLR** Write 1 to clear the interrupt for read operations in region 1 by Peripheral bus. (R/W)
- ASSIST_DEBUG_CORE_0_AREA_PIF_1_WR_CLR** Write 1 to clear the interrupt for write operations in region 1 by Peripheral bus. (R/W)
- ASSIST_DEBUG_CORE_0_SP_SPILL_MIN_CLR** Write 1 to clear the interrupt for SP exceeding the lower bound address of SP monitored region. (R/W)
- ASSIST_DEBUG_CORE_0_SP_SPILL_MAX_CLR** Write 1 to clear the interrupt for SP exceeding the upper bound address of SP monitored region. (R/W)

Register 17.30. ASSIST_DEBUG_CORE_0_RCD_EN_REG (0x0044)

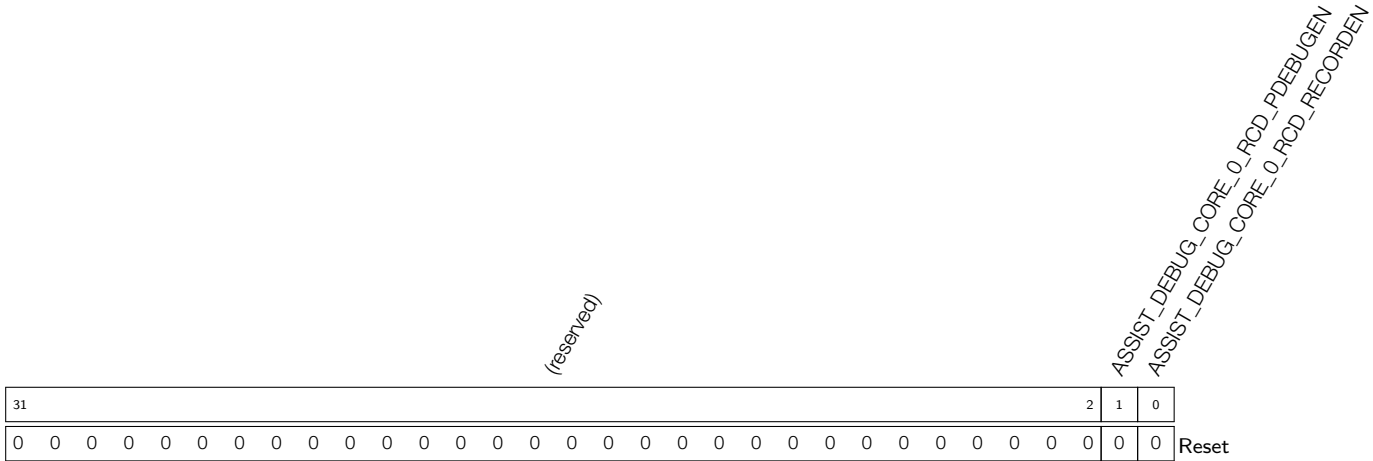

ASSIST_DEBUG_CORE_0_RCD_RECORDEREN Configures whether to enable PC logging.

0: Disable

1: [ASSIST_DEBUG_CORE_0_RCD_PDEBUGPC_REG](#) starts to record PC in real time

(R/W)

ASSIST_DEBUG_CORE_0_RCD_PDEBUGEN Configures whether to enable HP CPU debugging.

0: Disable

1: HP CPU outputs PC

(R/W)

Register 17.31. ASSIST_DEBUG_CORE_0_RCD_PDEBUGPC_REG (0x0048)



ASSIST_DEBUG_CORE_0_RCD_PDEBUGPC Represents the PC value at HP CPU reset. (RO)

Register 17.32. ASSIST_DEBUG_CORE_0_RCD_PDEBUGSP_REG (0x004C)

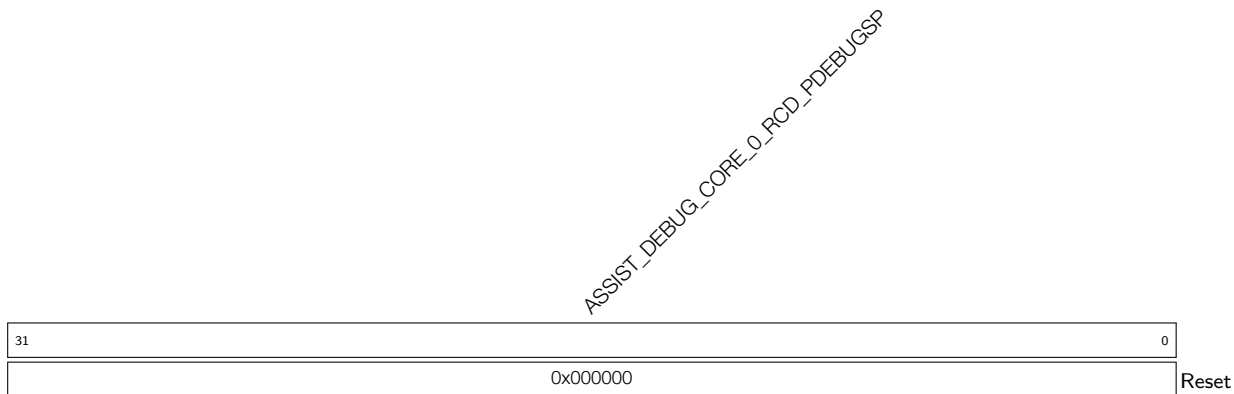

ASSIST_DEBUG_CORE_0_RCD_PDEBUGSP Represents SP. (RO)

Register 17.33. ASSIST_DEBUG_CORE_0_LASTPC_BEFORE_EXCEPTION_REG (0x0070)

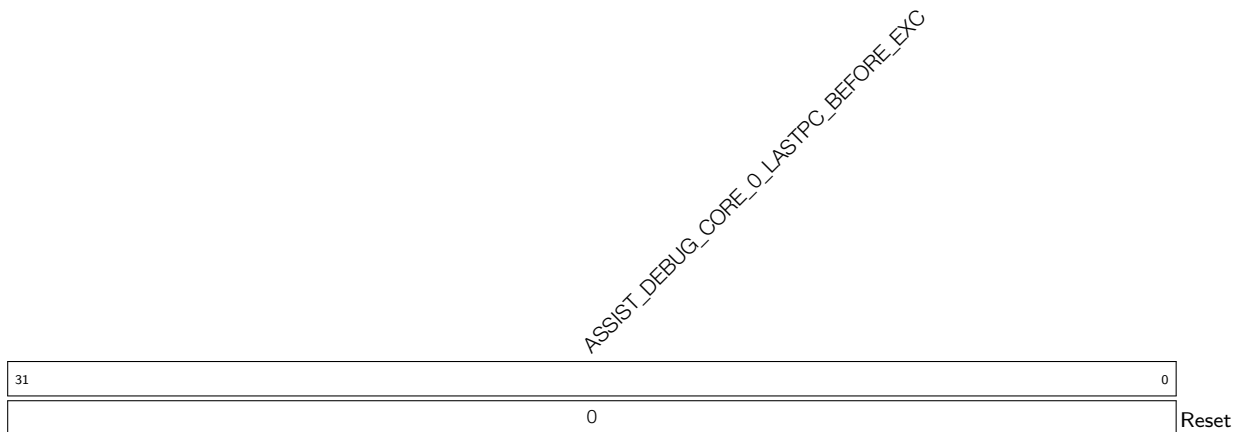

ASSIST_DEBUG_CORE_0_LASTPC_BEFORE_EXC Represents the PC of the last command before the HP CPU enters exception. (RO)

Register 17.34. ASSIST_DEBUG_CORE_0_DEBUG_MODE_REG (0x0074)

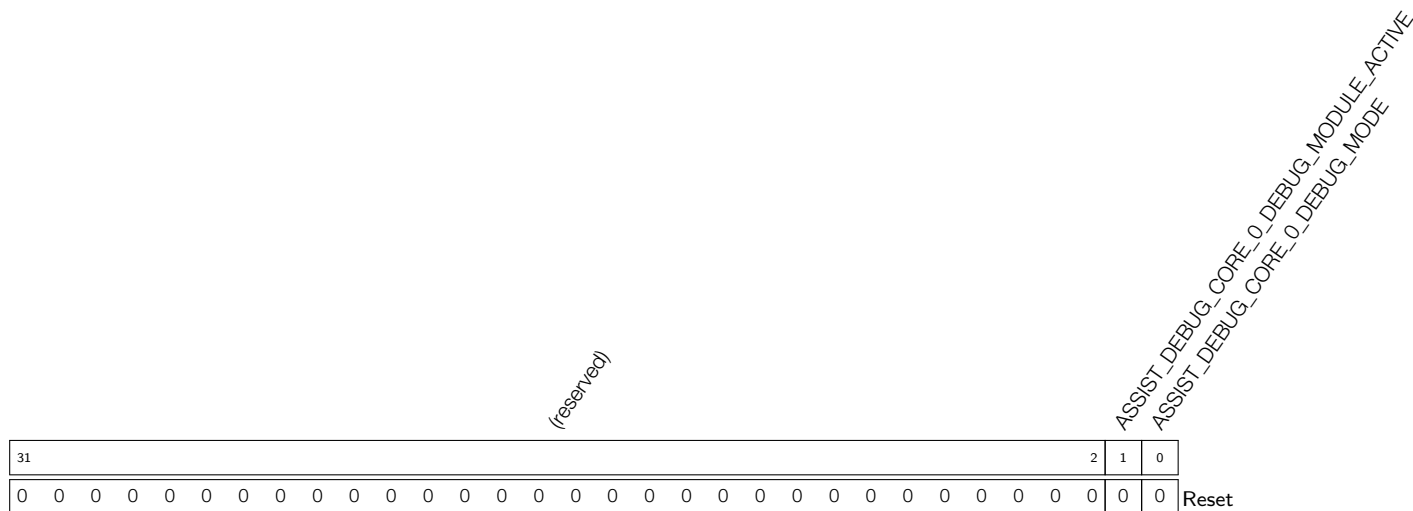

ASSIST_DEBUG_CORE_0_DEBUG_MODE Represents whether RISC-V CPU (HP CPU) is in debugging mode.
 1: In debugging mode
 0: Not in debugging mode
 (RO)

ASSIST_DEBUG_CORE_0_DEBUG_MODULE_ACTIVE Represents the status of the RISC-V CPU (HP CPU) debug module.
 1: Active status
 Other: Inactive status
 (RO)

Register 17.35. ASSIST_DEBUG_CLOCK_GATE_REG (0x0078)

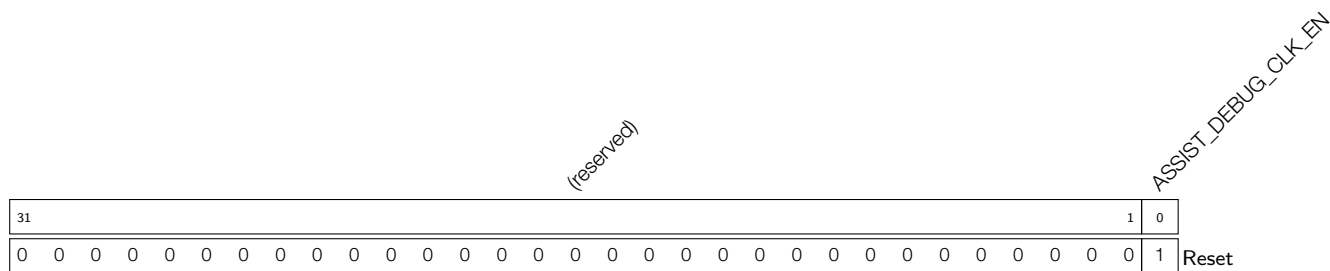

ASSIST_DEBUG_CLK_EN Configures whether to enable the register clock gating.
 0: Disable
 1: Enable
 (R/W)

Register 17.36. ASSIST_DEBUG_DATE_REG (0x03FC)

<i>(reserved)</i>				<i>ASSIST_DEBUG_DATE</i>												
31	28	27													0	
0	0	0	0	0x2109130												Reset

ASSIST_DEBUG_DATE Version control register. (R/W)

18 AES Accelerator (AES)

18.1 Introduction

ESP32-C6 integrates an Advanced Encryption Standard (AES) accelerator, which is a hardware device that speeds up computation using AES algorithm significantly, compared to AES algorithms implemented solely in software. The AES accelerator integrated in ESP32-C6 has two working modes, which are [Typical AES](#) and [DMA-AES](#).

18.2 Features

The following functionality is supported:

- Typical AES working mode
 - AES-128/AES-256 encryption and decryption
- DMA-AES working mode
 - AES-128/AES-256 encryption and decryption
 - Block cipher mode
 - * ECB (Electronic Codebook)
 - * CBC (Cipher Block Chaining)
 - * OFB (Output Feedback)
 - * CTR (Counter)
 - * CFB8 (8-bit Cipher Feedback)
 - * CFB128 (128-bit Cipher Feedback)
 - Interrupt on completion of computation

18.3 AES Working Modes

The AES accelerator integrated in ESP32-C6 has two working modes, which are [Typical AES](#) and [DMA-AES](#).

- Typical AES Working Mode:
 - Supports encryption and decryption using cryptographic keys of 128 and 256 bits, specified in [NIST FIPS 197](#).

In this working mode, the plaintext and ciphertext is written and read via CPU directly.

- DMA-AES Working Mode:
 - Supports encryption and decryption using cryptographic keys of 128 and 256 bits, specified in [NIST FIPS 197](#);
 - Supports block cipher modes ECB/CBC/OFB/CTR/CFB8/CFB128 under [NIST SP 800-38A](#).

In this working mode, the plaintext and ciphertext are written and read via DMA. An interrupt will be generated when operation completes.

The AES accelerator is activated by setting the [PCR_AES_CLK_EN](#) bit and clearing the [PCR_AES_RST_EN](#) bit in the [PCR_AES_CONF_REG](#) register. Additionally, users also need to clear [PCR_DS_RST_EN](#) bit to reset [Digital Signature \(DS\)](#).

Users can choose the working mode for AES accelerator by configuring the [AES_DMA_ENABLE_REG](#) register according to Table 18-1 below.

Table 18-1. AES Accelerator Working Mode

AES_DMA_ENABLE_REG	Working Mode
0	Typical AES
1	DMA-AES

Users can choose the length of cryptographic keys and encryption / decryption by configuring the [AES_MODE_REG](#) register according to Table 18-2 below.

Table 18-2. Key Length and Encryption/Decryption

AES_MODE_REG [2:0]	Key Length and Encryption / Decryption
0	AES-128 encryption
1	reserved
2	AES-256 encryption
3	reserved
4	AES-128 decryption
5	reserved
6	AES-256 decryption
7	reserved

For detailed introduction on these two working modes, please refer to Section 18.4 and Section 18.5 below.

Notice:

ESP32-C6's [Digital Signature \(DS\)](#) module will call the AES accelerator. Therefore, users cannot access the AES accelerator when [Digital Signature \(DS\)](#) module is working.

18.4 Typical AES Working Mode

In the Typical AES working mode, users can check the working status of the AES accelerator by inquiring the `AES_STATE_REG` register and comparing the return value against the Table 18-3 below.

Table 18-3. Working Status under Typical AES Working Mode

<code>AES_STATE_REG</code>	Status	Description
0	IDLE	The AES accelerator is idle or completed operation.
1	WORK	The AES accelerator is in the middle of an operation.

18.4.1 Key, Plaintext, and Ciphertext

The encryption or decryption key is stored in `AES_KEY_n_REG`, which is a set of eight 32-bit registers.

- For AES-128 encryption/decryption, the 128-bit key is stored in `AES_KEY_0_REG` ~ `AES_KEY_3_REG`.
- For AES-256 encryption/decryption, the 256-bit key is stored in `AES_KEY_0_REG` ~ `AES_KEY_7_REG`.

The plaintext and ciphertext are stored in `AES_TEXT_IN_m_REG` and `AES_TEXT_OUT_m_REG`, which are two sets of four 32-bit registers.

- For AES-128/AES-256 encryption, the `AES_TEXT_IN_m_REG` registers are initialized with plaintext. Then, the AES accelerator stores the ciphertext into `AES_TEXT_OUT_m_REG` after operation.
- For AES-128/AES-256 decryption, the `AES_TEXT_IN_m_REG` registers are initialized with ciphertext. Then, the AES accelerator stores the plaintext into `AES_TEXT_OUT_m_REG` after operation.

18.4.2 Endianness

Text Endianness

In Typical AES working mode, the AES accelerator uses cryptographic keys to encrypt and decrypt data in blocks of 128 bits. When filling data into `AES_TEXT_IN_m_REG` register or reading result from `AES_TEXT_OUT_m_REG` registers, users should follow the text endianness type specified in Table 18-4.

Table 18-4. Text Endianness Type for Typical AES

State ¹		Plaintext/Ciphertext			
		c ²			
		0	1	2	3
r	0	<code>AES_TEXT_x_0_REG[7:0]</code>	<code>AES_TEXT_x_1_REG[7:0]</code>	<code>AES_TEXT_x_2_REG[7:0]</code>	<code>AES_TEXT_x_3_REG[7:0]</code>
	1	<code>AES_TEXT_x_0_REG[15:8]</code>	<code>AES_TEXT_x_1_REG[15:8]</code>	<code>AES_TEXT_x_2_REG[15:8]</code>	<code>AES_TEXT_x_3_REG[15:8]</code>
	2	<code>AES_TEXT_x_0_REG[23:16]</code>	<code>AES_TEXT_x_1_REG[23:16]</code>	<code>AES_TEXT_x_2_REG[23:16]</code>	<code>AES_TEXT_x_3_REG[23:16]</code>
	3	<code>AES_TEXT_x_0_REG[31:24]</code>	<code>AES_TEXT_x_1_REG[31:24]</code>	<code>AES_TEXT_x_2_REG[31:24]</code>	<code>AES_TEXT_x_3_REG[31:24]</code>

¹ The definition of "State (including c and r)" is described in Section 3.4 The State in [NIST FIPS 197](#).

² Where *x* = IN or OUT.

Key Endianness

In Typical AES working mode, when filling key into `AES_KEY_m_REG` registers, users should follow the key endianness type specified in Table 18-5 and Table 18-6.

Table 18-5. Key Endianness Type for AES-128 Encryption and Decryption

Bit ¹	w[0]	w[1]	w[2]	w[3] ²
[31:24]	AES_KEY_0_REG[7:0]	AES_KEY_1_REG[7:0]	AES_KEY_2_REG[7:0]	AES_KEY_3_REG[7:0]
[23:16]	AES_KEY_0_REG[15:8]	AES_KEY_1_REG[15:8]	AES_KEY_2_REG[15:8]	AES_KEY_3_REG[15:8]
[15:8]	AES_KEY_0_REG[23:16]	AES_KEY_1_REG[23:16]	AES_KEY_2_REG[23:16]	AES_KEY_3_REG[23:16]
[7:0]	AES_KEY_0_REG[31:24]	AES_KEY_1_REG[31:24]	AES_KEY_2_REG[31:24]	AES_KEY_3_REG[31:24]

¹ Column “Bit” specifies the bytes of each word stored in w[0] ~ w[3].

² w[0] ~ w[3] are “the first Nk words of the expanded key” as specified in Section 5.2 Key Expansion in [NIST FIPS 197](#).

Table 18-6. Key Endianness Type for AES-256 Encryption and Decryption

Bit ¹	w[0]	w[1]	w[2]	w[3]	w[4]	w[5]	w[6]	w[7] ²
[31:24]	AES_KEY_0_REG[7:0]	AES_KEY_1_REG[7:0]	AES_KEY_2_REG[7:0]	AES_KEY_3_REG[7:0]	AES_KEY_4_REG[7:0]	AES_KEY_5_REG[7:0]	AES_KEY_6_REG[7:0]	AES_KEY_7_REG[7:0]
[23:16]	AES_KEY_0_REG[15:8]	AES_KEY_1_REG[15:8]	AES_KEY_2_REG[15:8]	AES_KEY_3_REG[15:8]	AES_KEY_4_REG[15:8]	AES_KEY_5_REG[15:8]	AES_KEY_6_REG[15:8]	AES_KEY_7_REG[15:8]
[15:8]	AES_KEY_0_REG[23:16]	AES_KEY_1_REG[23:16]	AES_KEY_2_REG[23:16]	AES_KEY_3_REG[23:16]	AES_KEY_4_REG[23:16]	AES_KEY_5_REG[23:16]	AES_KEY_6_REG[23:16]	AES_KEY_7_REG[23:16]
[7:0]	AES_KEY_0_REG[31:24]	AES_KEY_1_REG[31:24]	AES_KEY_2_REG[31:24]	AES_KEY_3_REG[31:24]	AES_KEY_4_REG[31:24]	AES_KEY_5_REG[31:24]	AES_KEY_6_REG[31:24]	AES_KEY_7_REG[31:24]

¹ Column “Bit” specifies the bytes of each word stored in w[0] ~ w[7].

² w[0] ~ w[7] are “the first Nk words of the expanded key” as specified in Chapter 5.2 Key Expansion in [NIST FIPS 197](#).

18.4.3 Operation Process

Single Operation

1. Write 0 to the [AES_DMA_ENABLE_REG](#) register.
2. Initialize registers [AES_MODE_REG](#), [AES_KEY_n_REG](#), [AES_TEXT_IN_m_REG](#).
3. Start operation by writing 1 to the [AES_TRIGGER_REG](#) register.
4. Wait till the content of the [AES_STATE_REG](#) register becomes 0, which indicates the operation is completed.
5. Read results from the [AES_TEXT_OUT_m_REG](#) register.

Consecutive Operations

In consecutive operations, primarily the input [AES_TEXT_IN_m_REG](#) and output [AES_TEXT_OUT_m_REG](#) registers are being written and read, while the content of [AES_DMA_ENABLE_REG](#), [AES_MODE_REG](#), [AES_KEY_n_REG](#) is kept unchanged. Therefore, the initialization can be simplified during the consecutive operation.

1. Write 0 to the [AES_DMA_ENABLE_REG](#) register before starting the first operation.
2. Initialize registers [AES_MODE_REG](#) and [AES_KEY_n_REG](#) before starting the first operation.
3. Update the content of [AES_TEXT_IN_m_REG](#).
4. Start operation by writing 1 to the [AES_TRIGGER_REG](#) register.
5. Wait till the content of the [AES_STATE_REG](#) register becomes 0, which indicates the operation completes.
6. Read results from the [AES_TEXT_OUT_m_REG](#) register, and return to Step 3 to continue the next operation.

18.5 DMA-AES Working Mode

In the DMA-AES working mode, the AES accelerator supports six block cipher modes including ECB/CBC/OFB/CTR/CFB8/CFB128. Users can choose the block cipher mode by configuring the [AES_BLOCK_MODE_REG](#) register according to Table 18-7 below.

Table 18-7. Block Cipher Mode

AES_BLOCK_MODE_REG [2:0]	Block Cipher Mode
0	ECB (Electronic Codebook)
1	CBC (Cipher Block Chaining)
2	OFB (Output Feedback)
3	CTR (Counter)
4	CFB8 (8-bit Cipher Feedback)
5	CFB128 (128-bit Cipher Feedback)
6	reserved
7	reserved

Users can check the working status of the AES accelerator by inquiring the [AES_STATE_REG](#) register and comparing the return value against the Table 18-8 below.

Table 18-8. Working Status under DMA-AES Working mode

AES_STATE_REG[1:0]	Status	Description
0	IDLE	The AES accelerator is idle.
1	WORK	The AES accelerator is in the middle of an operation.
2	DONE	The AES accelerator completed operations.

When working in the DMA-AES working mode, the AES accelerator supports interrupt on the completion of computation. To enable this function, write 1 to the [AES_INT_ENA_REG](#) register. By default, the interrupt function is disabled. Also, note that the interrupt should be cleared by software after use.

18.5.1 Key, Plaintext, and Ciphertext

Block Operation

During the block operations, the AES accelerator reads source data from DMA, and write result data to DMA after the computation.

- For encryption, DMA reads plaintext from memory, then passes it to AES as source data. After computation, AES passes ciphertext as result data back to DMA to write into memory.
- For decryption, DMA reads ciphertext from memory, then passes it to AES as source data. After computation, AES passes plaintext as result data back to DMA to write into memory.

During block operations, the lengths of the source data and result data are the same. The total computation time is reduced because the DMA data operation and AES computation can happen concurrently.

The length of source data for AES accelerator under DMA-AES working mode must be 128 bits or the integral multiples of 128 bits. Otherwise, trailing zeros will be added to the original source data, so the length of source data equals to the nearest integral multiples of 128 bits. Please see details in [Table 18-9](#) below.

Table 18-9. TEXT-PADDING

Function : TEXT-PADDING()	
Input	: X , bit string.
Output	: $Y = \text{TEXT-PADDING}(X)$, whose length is the nearest integral multiples of 128 bits.
Steps	
Let us assume that X is a data-stream that can be split into n parts as following:	
$X = X_1 X_2 \dots X_{n-1} X_n$	
Here, the lengths of X_1, X_2, \dots, X_{n-1} all equal to 128 bits, and the length of X_n is t ($0 <= t <= 127$).	
If $t = 0$, then	
$\text{TEXT-PADDING}(X) = X;$	
If $0 < t <= 127$, define a 128-bit block, X_n^* , and let $X_n^* = X_n 0^{128-t}$, then	
$\text{TEXT-PADDING}(X) = X_1 X_2 \dots X_{n-1} X_n^* = X 0^{128-t}$	

18.5.2 Endianness

Under the DMA-AES working mode, the transmission of source data and result data for AES accelerator is solely controlled by DMA. Therefore, the AES accelerator cannot control the Endianness of the source data and result

data, but does have requirement on how these data should be stored in memory and on the length of the data.

For example, let us assume DMA needs to write the following data into memory at address 0x0280.

- Data represented in hexadecimal:
 - 0102030405060708090A0B0C0D0E0F101112131415161718191A1B1C1D1E1F20
- Data Length:
 - Equals to 2 blocks.

Then, this data will be stored in memory as shown in Table 18-10 below.

Table 18-10. Text Endianness for DMA-AES

Address	Byte	Address	Byte	Address	Byte	Address	Byte
0x0280	0x01	0x0281	0x02	0x0282	0x03	0x0283	0x04
0x0284	0x05	0x0285	0x06	0x0286	0x07	0x0287	0x08
0x0288	0x09	0x0289	0x0A	0x028A	0x0B	0x028B	0x0C
0x028C	0x0D	0x028D	0x0E	0x028E	0x0F	0x028F	0x10
0x0290	0x11	0x0291	0x12	0x0292	0x13	0x0293	0x14
0x0294	0x15	0x0295	0x16	0x0296	0x17	0x0297	0x18
0x0298	0x19	0x0299	0x1A	0x029A	0x1B	0x029B	0x1C
0x029C	0x1D	0x029D	0x1E	0x029E	0x1F	0x029F	0x20

18.5.3 Standard Incrementing Function

AES accelerator provides two Standard Incrementing Functions for the CTR block operation, which are INC_{32} and INC_{128} Standard Incrementing Functions. By setting the `AES_INC_SEL_REG` register to 0 or 1, users can choose the INC_{32} or INC_{128} functions respectively. For details on the Standard Incrementing Function, please see Chapter B.1 The Standard Incrementing Function in [NIST SP 800-38A](#).

18.5.4 Block Number

Register `AES_BLOCK_NUM_REG` stores the Block Number of plaintext P or ciphertext C . The length of this register equals to $\text{length}(\text{TEXT-PADDING}(P))/128$ or $\text{length}(\text{TEXT-PADDING}(C))/128$. The AES accelerator only uses this register when working in the DMA-AES mode.

18.5.5 Initialization Vector

`AES_IV_MEM` is a 16-byte memory, which is only available for AES accelerator working in block operations. For CBC/OFB/CFB8/CFB128 operations, the `AES_IV_MEM` memory stores the Initialization Vector (IV). For the CTR operation, the `AES_IV_MEM` memory stores the Initial Counter Block (ICB).

Both IV and ICB are 128-bit strings, which can be divided into Byte0, Byte1, Byte2 ... Byte15 (from left to right). `AES_IV_MEM` stores data following the Endianness pattern presented in Table 18-10, i.e. the most significant (i.e., left-most) byte Byte0 is stored at the lowest address while the least significant (i.e., right-most) byte Byte15 at the highest address.

For more details on IV and ICB, please refer to [NIST SP 800-38A](#).

18.5.6 Block Operation Process

1. Select one of DMA channels to connect with AES, configure the DMA chained list, and then start DMA. For details, please refer to Chapter 4 *GDMA Controller (GDMA)*.
2. Initialize the AES accelerator-related registers:
 - Write 1 to the [AES_DMA_ENABLE_REG](#) register.
 - Configure the [AES_INT_ENA_REG](#) register to enable or disable the interrupt function.
 - Initialize registers [AES_MODE_REG](#) and [AES_KEY_n_REG](#).
 - Select block cipher mode by configuring the [AES_BLOCK_MODE_REG](#) register. For details, see Table 18-7.
 - Initialize the [AES_BLOCK_NUM_REG](#) register. For details, see Section 18.5.4.
 - Initialize the [AES_INC_SEL_REG](#) register (only needed when AES accelerator is working under CTR block operation).
 - Initialize the [AES_IV_MEM](#) memory (This is always needed except for ECB block operation).
3. Start operation by writing 1 to the [AES_TRIGGER_REG](#) register.
4. Wait for the completion of computation, which happens when the content of [AES_STATE_REG](#) becomes 2 or the AES interrupt occurs.
5. Check if DMA completes data transmission from AES to memory. At this time, DMA had already written the result data in memory, which can be accessed directly. For details on DMA, please refer to Chapter 4 *GDMA Controller (GDMA)*.
6. Clear interrupt by writing 1 to the [AES_INT_CLEAR_REG](#) register, if any AES interrupt occurred during the computation.
7. Release the AES accelerator by writing 1 to the [AES_DMA_EXIT_REG](#) register. After this, the content of the [AES_STATE_REG](#) register becomes 0. Note that, you can release DMA earlier, but only after Step 4 is completed.

18.6 Memory Summary

The addresses in this section are relative to the AES accelerator base address provided in Table 5-2 in Chapter 5 *System and Memory*.

The abbreviations given in Column **Access** are explained in Section *Access Types for Registers*.

Name	Description	Size (byte)	Starting Address	Ending Address	Access
AES_IV_MEM	Memory IV	16 bytes	0x0050	0x005F	R/W

18.7 Register Summary

The addresses in this section are relative to the AES accelerator base address provided in Table 5-2 in Chapter 5 *System and Memory*.

The abbreviations given in Column **Access** are explained in Section *Access Types for Registers*.

Name	Description	Address	Access
Key Registers			
AES_KEY_0_REG	AES key data register 0	0x0000	R/W
AES_KEY_1_REG	AES key data register 1	0x0004	R/W
AES_KEY_2_REG	AES key data register 2	0x0008	R/W
AES_KEY_3_REG	AES key data register 3	0x000C	R/W
AES_KEY_4_REG	AES key data register 4	0x0010	R/W
AES_KEY_5_REG	AES key data register 5	0x0014	R/W
AES_KEY_6_REG	AES key data register 6	0x0018	R/W
AES_KEY_7_REG	AES key data register 7	0x001C	R/W
TEXT_IN Registers			
AES_TEXT_IN_0_REG	Source text data register 0	0x0020	R/W
AES_TEXT_IN_1_REG	Source text data register 1	0x0024	R/W
AES_TEXT_IN_2_REG	Source text data register 2	0x0028	R/W
AES_TEXT_IN_3_REG	Source text data register 3	0x002C	R/W
TEXT_OUT Registers			
AES_TEXT_OUT_0_REG	Result text data register 0	0x0030	RO
AES_TEXT_OUT_1_REG	Result text data register 1	0x0034	RO
AES_TEXT_OUT_2_REG	Result text data register 2	0x0038	RO
AES_TEXT_OUT_3_REG	Result text data register 3	0x003C	RO
Control / Configuration Registers			
AES_MODE_REG	Defines key length and encryption / decryption	0x0040	R/W
AES_DMA_ENABLE_REG	Selects the working mode of the AES accelerator	0x0090	R/W
AES_BLOCK_MODE_REG	Defines the block cipher mode	0x0094	R/W
AES_BLOCK_NUM_REG	Block number configuration register	0x0098	R/W
AES_INC_SEL_REG	Standard incrementing function register	0x009C	R/W
AES_TRIGGER_REG	Operation start controlling register	0x0048	WO
AES_DMA_EXIT_REG	Operation exit controlling register	0x00B8	WO
Status Register			
AES_STATE_REG	Operation status register	0x004C	RO
Interrupt Registers			
AES_INT_CLEAR_REG	DMA-AES interrupt clear register	0x00AC	WO
AES_INT_ENA_REG	DMA-AES interrupt enable register	0x00B0	R/W

18.8 Registers

The addresses in this section are relative to the AES accelerator base address provided in Table 5-2 in Chapter 5 *System and Memory*.

Register 18.1. AES_KEY_n_REG ($n: 0-7$) ($0x0000+4*n$)

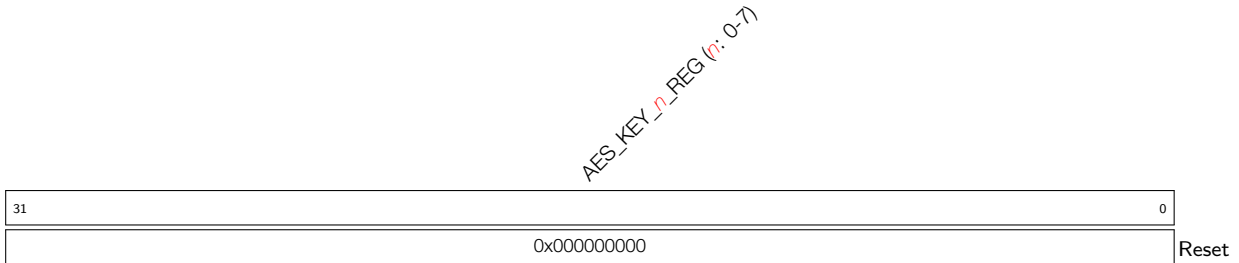

AES_KEY_n_REG ($n: 0-7$) Represents AES key data. (R/W)

Register 18.2. AES_TEXT_IN_m_REG ($m: 0-3$) ($0x0020+4*m$)

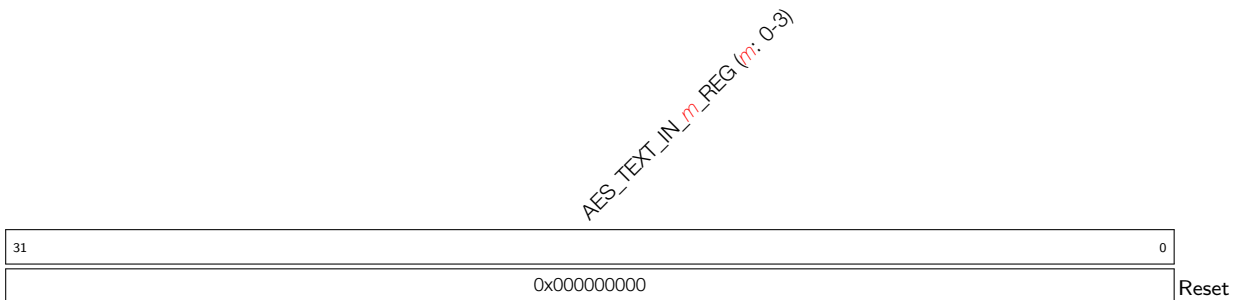

AES_TEXT_IN_m_REG ($m: 0-3$) Represents the source text data when the AES accelerator operates in the Typical AES working mode. (R/W)

Register 18.3. AES_TEXT_OUT_m_REG ($m: 0-3$) ($0x0030+4*m$)

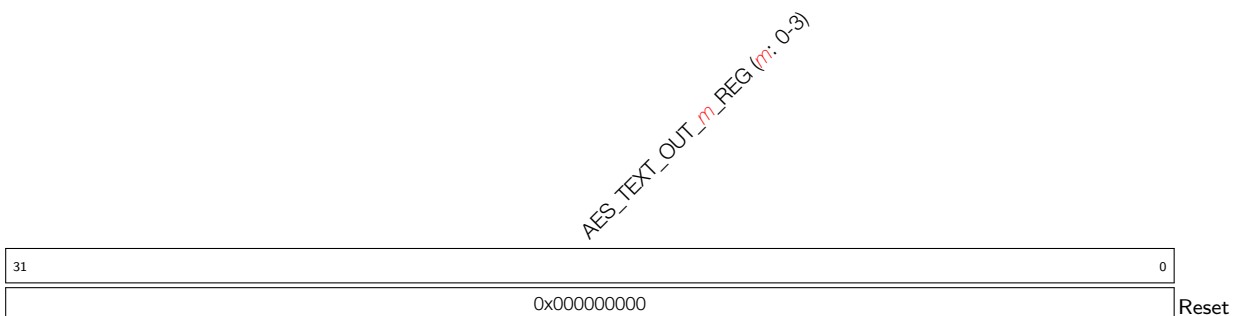

AES_TEXT_OUT_m_REG ($m: 0-3$) Represents the result text data when the AES accelerator operates in the Typical AES working mode. (RO)

Register 18.4. AES_MODE_REG (0x0040)

31	(reserved)	3	2	0	AES_MODE
0x00000000				0	Reset

AES_MODE Configures the key length and encryption / decryption of the AES accelerator.

- 0: AES-128 encryption
 - 1: Reserved
 - 2: AES-256 encryption
 - 3: Reserved
 - 4: AES-128 decryption
 - 5: Reserved
 - 6: AES-256 decryption
 - 7: Reserved
- (R/W)

Register 18.5. AES_DMA_ENABLE_REG (0x0090)

31	(reserved)	1	0	AES_DMA_ENABLE	
0x00000000				0	Reset

AES_DMA_ENABLE Configures the working mode of the AES accelerator.

- 0: Typical AES
 - 1: DMA-AES
- (R/W)

Register 18.6. AES_BLOCK_MODE_REG (0x0094)

31	(reserved)	3	2	0	
0x00000000				0	Reset

AES_BLOCK_MODE Configures the block cipher mode of the AES accelerator operating under the DMA-AES working mode.

- 0: ECB (Electronic Code Block)
- 1: CBC (Cipher Block Chaining)
- 2: OFB (Output FeedBack)
- 3: CTR (Counter)
- 4: CFB8 (8-bit Cipher FeedBack)
- 5: CFB128 (128-bit Cipher FeedBack)
- 6: Reserved
- 7: Reserved

(R/W)

Register 18.7. AES_BLOCK_NUM_REG (0x0098)

31	AES_BLOCK_NUM	0
0x00000000		Reset

AES_BLOCK_NUM Represents the Block Number of plaintext or ciphertext when the AES accelerator operates under the DMA-AES working mode. For details, see Section 18.5.4. (R/W)

Register 18.8. AES_INC_SEL_REG (0x009C)

31	(reserved)	1	0	
0x00000000			0	Reset

AES_INC_SEL Configures the Standard Incrementing Function for CTR block operation.

- 0: INC₃₂
- 1: INC₁₂₈

(R/W)

Register 18.9. AES_TRIGGER_REG (0x0048)

31	<i>(reserved)</i>	1	0	
0x00000000				x
				Reset

AES_TRIGGER Configures whether or not to start AES operation.

0: No effect

1: Start

(WO)

Register 18.10. AES_STATE_REG (0x004C)

31	<i>(reserved)</i>	2	1	0	
0x00000000				0x0	
				Reset	

AES_STATE Represents the working status of the AES accelerator.

In Typical AES working mode:

0: IDLE

1: WORK

2: No effect

3: No effect

In DMA-AES working mode:

0: IDLE

1: WORK

2: DONE

3: No effect

(RO)

Register 18.11. AES_DMA_EXIT_REG (0x00B8)

31	<i>(reserved)</i>	1	0	<i>AES_DMA_EXIT</i>
0x00000000				

AES_DMA_EXIT Configures whether or not to exit AES operation.

0: No effect

1: Exit

Only valid for DMA-AES operation. (WO)

Register 18.12. AES_INT_CLEAR_REG (0x00AC)

31	<i>(reserved)</i>	1	0	<i>AES_INT_CLEAR</i>
0x00000000				

AES_INT_CLEAR Configures whether or not to clear AES interrupt.

0: No effect

1: Clear

(WO)

Register 18.13. AES_INT_ENA_REG (0x00B0)

31	<i>(reserved)</i>	1	0	<i>AES_INT_ENA</i>
0x00000000				

AES_INT_ENA Configures whether or not to enable AES interrupt.

0: Disable

1: Enable

(R/W)

19 ECC Accelerator (ECC)

19.1 Introduction

Elliptic Curve Cryptography (ECC) is an approach to public-key cryptography based on the algebraic structure of elliptic curves. ECC allows smaller keys compared to RSA cryptography while providing equivalent security.

ESP32-C6's ECC Accelerator can complete various calculations based on different elliptic curves, thus accelerating the ECC algorithm and ECC-derived algorithms (such as ECDSA).

19.2 Features

ESP32-C6's ECC Accelerator has the following features:

- Two different elliptic curves, namely P-192 and P-256 defined in [FIPS 186-3](#)
- Six working modes
- Interrupt upon completion of calculation

19.3 Terminology

This section covers terminology used to describe ECC Accelerator.

19.3.1 ECC Basics

19.3.1.1 Elliptic Curve and Points on the Curves

The ECC algorithm is based on elliptic curves over prime fields, which can be represented as:

$$y^2 = x^3 + ax + b \pmod{p}$$

where,

- p is a prime number,
- a and b are two non-negative integers smaller than p ,
- and (x, y) is a point on the curve satisfying the representation.

19.3.1.2 Affine Coordinates and Jacobian Coordinates

An elliptic curve can be represented as below:

- In affine coordinates:

$$y^2 = x^3 + ax + b \pmod{p}$$

- In a Jacobian coordinates:

$$Y^2 = X^3 + aXZ^4 + bZ^6 \pmod{p}$$

To convert affine coordinates (x, y) to/from Jacobian coordinates (X, Y, Z) :

- From Jacobian to Affine coordinates

$$x = X/Z^2 \bmod p$$

$$y = Y/Z^3 \bmod p$$

- From Affine to Jacobian coordinates

$$X = x$$

$$Y = y$$

$$Z = 1$$

19.3.2 Definitions of ESP32-C6's ECC

19.3.2.1 Memory Blocks

ECC's memory blocks store input data and output data of the ECC operation.

Table 19-1. ECC Accelerator Memory Blocks

Memory	Size (byte)	Starting Address*	Ending Address*	Access
ECC_Mem_k	32	0x100	0x11F	R/W
ECC_Mem_Px	32	0x120	0x13F	R/W
ECC_Mem_Py	32	0x140	0x15F	R/W

* Address offset related to ECC accelerator base address is provided in Table 5-2 in Chapter 5 *System and Memory*.

19.3.2.2 Data and Data Block

ESP32-C6's ECC operates on data of 256 bits. This data ($D[255 : 0]$) can be divided into eight 32-bit data blocks $D[n][31 : 0]$ ($n = 0, 1, \dots, 7$). Data blocks with the smaller serial number correspond to the lower binary bits. To be specific:

$$D[255 : 0] = D[7][31 : 0], D[6][31 : 0], D[5][31 : 0], D[4][31 : 0], D[3][31 : 0], D[2][31 : 0], D[1][31 : 0], D[0][31 : 0]$$

19.3.2.3 Write Data

Write data means writing data to an ECC memory block and using this data as the input to the ECC algorithm. To be specific, write data to an ECC memory block means writing $D[n][31 : 0]$ ($n = 0, 1, \dots, 7$) to the "starting address of this ECC memory block + $4 \times n$ " successively:

- write $D[0]$ to "starting address"
- write $D[1]$ to "starting address + 4"
- ...
- write $D[7]$ to "starting address + 28"

Note:

When the key size of 192 bits is used, you need to append 0 before 192 bits of data and write 256 bits of data.

19.3.2.4 Read Data

Read data means reading data from the starting address of an ECC memory block and using this data as the output from the ECC algorithm. To be specific, read data from an ECC memory block means reading $D[n][31 : 0]$ ($n = 0, 1, \dots, 7$) from the “starting address of this ECC memory block + $4 \times n$ ” successively:

- read $D[0]$ from “starting address”
- read $D[1]$ from “starting address + 4”
- ...
- read $D[7]$ from “starting address + 28”

Note:

When the key size of 192 bits is used, only read the low 192 bits (6 blocks) of data.

19.3.2.5 Standard Calculation and Jacobian Calculation

ESP32-C6’s ECC performs Base Point Calculation (including Base Point Verification and Base Point Multiplication) using the affine coordinates and Jacobian Calculation (including Jacobian Point Verification and Jacobian Point Multiplication) using the Jacobian coordinates.

19.4 Function Description

19.4.1 Key Size

ESP32-C6’s ECC supports acceleration based on two key sizes (corresponding to two different elliptic curves). By configuring the `ECC_KEY_LENGTH` field, users can select the desired key size. For details, see Table 19-2 below.

Table 19-2. ECC Accelerator Key Size Selection

<code>ECC_KEY_LENGTH</code>	Elliptic Curves*
1'b0	FIPS P-192
1'b1	FIPS P-256

* See definition of FIPS P-192 and P-256 in [FIPS 186-3](#).

19.4.2 Working Modes

ESP32-C6’s ECC accelerator supports six working modes based on two elliptic curves described in the above section. By configuring the `ECC_WORK_MODE` field, users can choose the desired working mode. For details, see Table 19-3.

Table 19-3. ECC Accelerator's Working Modes

ECC_WORK_MODE	Working Modes	ECC_WORK_MODE	Working Modes
3'd0	Point Multi	3'd4	Jacobian Point Multi
3'd1	Reserved	3'd5	Reserved
3'd2	Point Verif	3'd6	Jacobian Point Verif
3'd3	Point Verif + Multi	3'd7	Point Verif + Jacobian Point Multi

Detailed descriptions about different working modes are provided in the following sections.

19.4.2.1 Base Point Multiplication (Point Multi Mode)

Base Point Multiplication can be represented as:

$$(Q_x, Q_y) = k \cdot (P_x, P_y)$$

where,

- Input: P_x , P_y , and k are stored in `ECC_Mem_Px`, `ECC_Mem_Py`, and `ECC_Mem_k` respectively.
- Output: Q_x and Q_y are stored in `ECC_Mem_Px` and `ECC_Mem_Py` respectively.

19.4.2.2 Base Point Verification (Point Verif Mode)

Base Point Verification can be used to verify if a point (P_x, P_y) is on a selected elliptic curve.

- Input: P_x and P_y are stored in `ECC_Mem_Px` and `ECC_Mem_Py` respectively.
- Output: the verification result is stored in the `ECC_VERIFICATION_RESULT` field.

19.4.2.3 Base Point Verification + Base Point Multiplication (Point Verif + Multi Mode)

In this working mode, ECC first verifies if Point (P_x, P_y) is on the selected elliptic curve. If so, the following multiplication is performed:

$$(Q_x, Q_y) = k \cdot (P_x, P_y)$$

where,

- Input: P_x , P_y , and k are stored in `ECC_Mem_Px`, `ECC_Mem_Py`, and `ECC_Mem_k` respectively.
- Output:
 - the verification result is stored in the `ECC_VERIFICATION_RESULT` field.
 - Q_x and Q_y are stored in `ECC_Mem_Px` and `ECC_Mem_Py` respectively.

19.4.2.4 Jacobian Point Multiplication (Jacobian Point Multi Mode)

Jacobian Point Multiplication can be represented as:

$$(Q_x, Q_y, Q_z) = k \cdot (P_x, P_y, 1)$$

where,

- (Q_x, Q_y, Q_z) is a Jacobian point on the selected elliptic curve.

- 1 in the point's Jacobian coordinates is auto completed by hardware.
- Input: P_x , P_y , and k are stored in `ECC_Mem_Px`, `ECC_Mem_Py`, and `ECC_Mem_k` respectively.
- Output: Q_x , Q_y , and Q_z are stored in `ECC_Mem_Px`, `ECC_Mem_Py`, and `ECC_Mem_k` respectively.

19.4.2.5 Jacobian Point Verification (Jacobian Point Verif Mode)

Jacobian Point Verification can be used to verify if a point (Q_x, Q_y, Q_z) is on a selected elliptic curve.

- (Q_x, Q_y, Q_z) is the point in Jacobian Coordinates.
- Input: Q_x , Q_y , and Q_z are stored in `ECC_Mem_Px`, `ECC_Mem_Py`, and `ECC_Mem_k` respectively.
- Output: the verification result is stored in the `ECC_VERIFICATION_RESULT` field.

19.4.2.6 Base Point Verification + Jacobian Point Multiplication (Point Verif + Jacobian Point Multi Mode)

In this working mode, ECC first verifies if Point (P_x, P_y) is on the selected elliptic curve. If so, the following multiplication is performed:

$$(Q_x, Q_y, Q_z) = k \cdot (P_x, P_y, 1)$$

where,

- (Q_x, Q_y, Q_z) is a Jacobian point on the selected elliptic curve.
- 1 in the point's Jacobian coordinates is auto completed by hardware.
- Input: P_x , P_y , and k are stored in `ECC_Mem_Px`, `ECC_Mem_Py`, and `ECC_Mem_k`.
- Output:
 - the verification result is stored in the `ECC_VERIFICATION_RESULT` field.
 - Q_x , Q_y , and Q_z are stored in `ECC_Mem_Px`, `ECC_Mem_Py`, and `ECC_Mem_k`.

19.5 Clocks and Resets

ESP32-C6's ECC only has one clock module (CRYPTO_ECC_CLK) and one reset module (CRYPTO_ECC_RST). Users should enable the ECC clock and disable the ECC reset before starting the ECC accelerator. For details on how to configure the ECC clock and reset, please refer to Chapter 8 [Reset and Clock](#).

19.6 Interrupts

ESP32-C6's ECC accelerator can generate one interrupt signal `ECC_INTR` and send it to [Interrupt Matrix](#).

Note:

Each interrupt signal is generated by any of its interrupt sources, i.e., any of its interrupt sources triggered can generate the interrupt signal.

`ECC_INTR` has only one interrupt source, i.e., `ECC_CALC_DONE_INT`, which is triggered on the completion of an ECC calculation. This `ECC_CALC_DONE_INT` interrupt source is configured by the following registers:

- [ECC_CALC_DONE_INT_RAW](#): stores the raw interrupt status of ECC_CALC_DONE_INT.
- [ECC_CALC_DONE_INT_ST](#): indicates the status of the ECC_CALC_DONE_INT interrupt. This field is generated by enabling/disabling the [ECC_CALC_DONE_INT_RAW](#) field via [ECC_CALC_DONE_INT_ENA](#).
- [ECC_CALC_DONE_INT_ENA](#): enables/disables the ECC_CALC_DONE_INT interrupt.
- [ECC_CALC_DONE_INT_CLR](#): set this bit to clear the ECC_CALC_DONE_INT interrupt status. By setting this bit to 1, fields [ECC_CALC_DONE_INT_RAW](#) and [ECC_CALC_DONE_INT_ST](#) will be cleared.

19.7 Programming Procedures

The programming procedure for configuring ECC is described below:

1. Configure the ECC clock and reset.
2. Choose the key size and working mode as described in Section [19.4](#).
3. Enable the ECC_CALC_DONE_INT interrupt as described in Section [19.6](#).
4. Set the [ECC_START](#) field to start ECC calculation.
5. Wait for the ECC_CALC_DONE_INT interrupt, which indicates the completion of the ECC calculation.
6. Check the result as described in Section [19.4](#).

19.8 Register Summary

The addresses in this section are relative to ECC Accelerator base address provided in Table 5-2 in Chapter 5 *System and Memory*.

The abbreviations given in Column **Access** are explained in Section *Access Types for Registers*.

Name	Description	Address	Access
Interrupt Registers			
ECC_MULT_INT_RAW_REG	ECC raw interrupt status register	0x000C	RO/WTC/SS
ECC_MULT_INT_ST_REG	ECC masked interrupt status register	0x0010	RO
ECC_MULT_INT_ENA_REG	ECC interrupt enable register	0x0014	R/W
ECC_MULT_INT_CLR_REG	ECC interrupt clear register	0x0018	WT
Configuration Register			
ECC_MULT_CONF_REG	ECC configuration register	0x001C	varies
Version Register			
ECC_MULT_DATE_REG	Version control register	0x00FC	R/W

19.9 Registers

The addresses in this section are relative to ECC Accelerator base address provided in Table 5-2 in Chapter 5 *System and Memory*.

Register 19.1. ECC_MULT_INT_RAW_REG (0x000C)

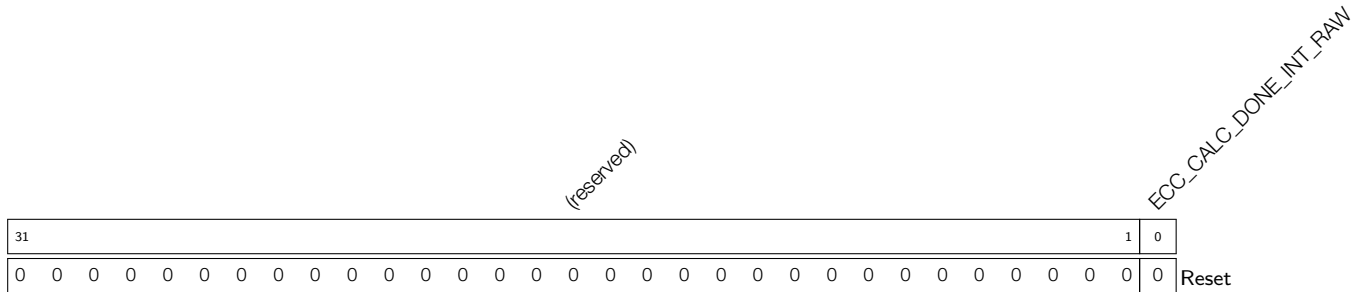

ECC_CALC_DONE_INT_RAW The raw interrupt status of the [ECC_CALC_DONE_INT](#) interrupt. (R/SS/WTC)

Register 19.2. ECC_MULT_INT_ST_REG (0x0010)

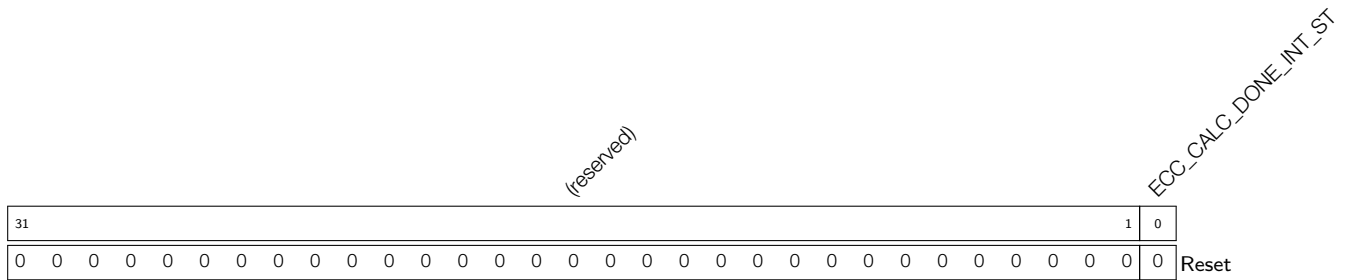

ECC_CALC_DONE_INT_ST The masked interrupt status of the [ECC_CALC_DONE_INT](#) interrupt. (RO)

Register 19.3. ECC_MULT_INT_ENA_REG (0x0014)

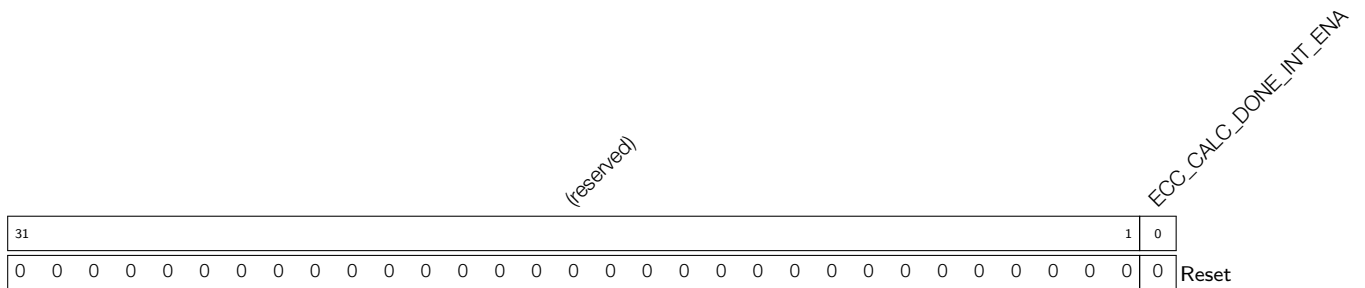

ECC_CALC_DONE_INT_ENA Write 1 to enable the [ECC_CALC_DONE_INT](#) interrupt. (R/W)

Register 19.4. ECC_MULT_INT_CLR_REG (0x0018)

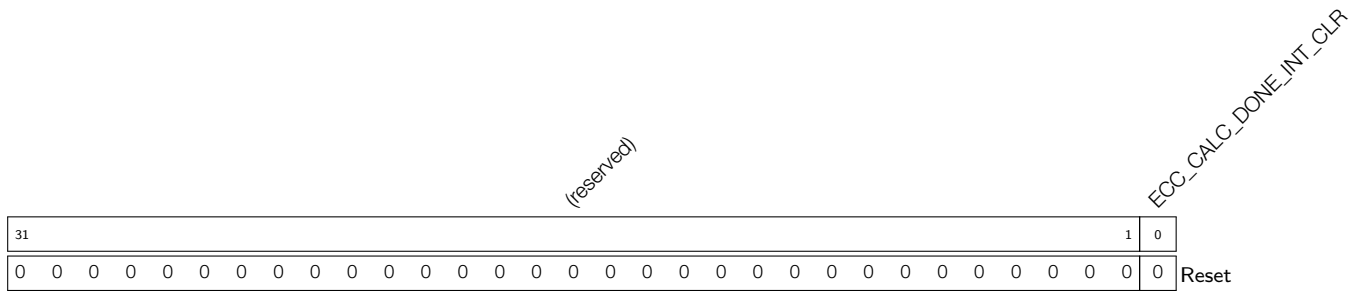

ECC_CALC_DONE_INT_CLR Write 1 to clear the [ECC_CALC_DONE_INT](#) interrupt. (WT)

Register 19.5. ECC_MULT_CONF_REG (0x001C)

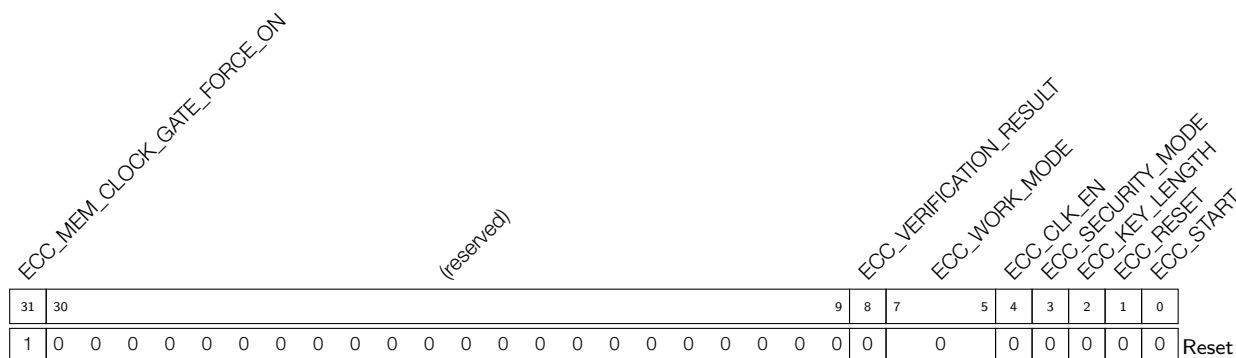

ECC_START Configures whether to start calculation of ECC Accelerator. This bit will be self-cleared after the calculation is done.

- 0: No effect
 - 1: Start calculation of ECC Accelerator
- (R/W/SC)

ECC_RESET Configures whether to reset ECC Accelerator.

- 0: No effect
 - 1: Reset
- (WT)

ECC_KEY_LENGTH Configures the key length mode bit of ECC Accelerator.

- 0: P-192
 - 1: P-256
- (R/W)

ECC_SECURITY_MODE Reserved. (R/W)

ECC_CLK_EN Configures whether to force on register clock gate.

- 0: No effect
 - 1: Force on
- (R/W)

ECC_WORK_MODE Configures the work mode of ECC Accelerator.

- 0: Point Multi mode
 - 1: Reserved
 - 2: Point Verif mode
 - 3: Point Verif + Multi mode
 - 4: Jacobian Point Multi mode
 - 5: Reserved
 - 6: Jacobian Point Verif mode
 - 7: Point Verif + Jacobian Point Multi mode
- (R/W)

ECC_VERIFICATION_RESULT Represents the verification result of ECC Accelerator, valid only when calculation is done. (R/SS)

Continued on the next page...

Register 19.5. ECC_MULT_CONF_REG (0x001C)

Continued from the previous page...

ECC_MEM_CLOCK_GATE_FORCE_ON Configures whether to force on ECC memory clock gate.

0: No effect

1: Force on

(R/W)

Register 19.6. ECC_MULT_DATE_REG (0x00FC)

<i>(reserved)</i>				<i>ECC_DATE</i>																
31	28	27																	0	
0	0	0	0	0x2201240																Reset

ECC_DATE Version control register. (R/W)

20 HMAC Accelerator (HMAC)

The Hash-based Message Authentication Code (HMAC) module computes Message Authentication Codes (MACs) using Hash algorithm SHA-256 and keys as described in RFC 2104. The 256-bit HMAC key is stored in an eFuse key block and can be set as read-protected, i. e., the key is not accessible from outside the HMAC accelerator.

20.1 Main Features

- Standard HMAC-SHA-256 algorithm
- Hash result only accessible by configurable hardware peripheral (in downstream mode)
- Compatibility with challenge-response authentication algorithm
- Required keys for the Digital Signature (DS) peripheral (in downstream mode)
- Re-enabled soft-disabled JTAG (in downstream mode)

20.2 Functional Description

The HMAC module operates in two modes: upstream mode and downstream mode. In upstream mode, users provide the HMAC message and read back the calculation result. In downstream mode, the HMAC module is used as a Key Derivation Function (KDF) for other internal hardware. For instance, the JTAG can be temporarily disabled by burning odd number bits of EFUSE_SOFT_DIS_JTAG in eFuse. In this case, users can temporarily re-enable JTAG using the HMAC module in downstream mode.

After the reset signal being released, the HMAC module will check whether the DS key exists in the eFuse. If the key exists, the HMAC module will enter downstream digital signature mode and finish the DS key calculation automatically.

20.2.1 Upstream Mode

Common use cases for the upstream mode are challenge-response protocols supporting HMAC-SHA-256. Assume the two entities in the challenge-response protocol are A and B respectively, and the data message they expect to exchange is M. The general authentication process of this protocol is as follows:

- A calculates a unique random number M.
- A sends M to B.
- B calculates the HMAC (through M and KEY) and sends the result to A.
- A calculates the HMAC (through M and KEY) internally.
- A compares the two results. If the results are the same, then the identity of B is authenticated.

To calculate the HMAC value, users should perform the following steps:

1. Initialize the HMAC module, and enter upstream mode.
2. Write the correctly padded message to the HMAC, one block at a time.
3. Read back the result from HMAC.

For details of this process, please see Section [20.2.5](#).

PRELIMINARY

20.2.2 Downstream JTAG Enable Mode

JTAG debugging can be disabled in a way which allows later re-enabling using the HMAC module. The HMAC module will expect the user to supply the HMAC result for one of the eFuse keys. The HMAC module will check whether the supplied HMAC matches the one calculated from the chosen key. If both HMACs are the same, JTAG will be enabled until the user calls the HMAC module to clear the results and consequently disable JTAG again.

There are two parameters in eFuse memory to disable JTAG: `EFUSE_DIS_PAD_JTAG` and `EFUSE_SOFT_DIS_JTAG`. Write 1 to `EFUSE_DIS_PAD_JTAG` to disable JTAG permanently, and write odd numbers of 1 to `EFUSE_SOFT_DIS_JTAG` to disable JTAG temporarily. For more details, please see Chapter 6 *eFuse Controller*. After bit `EFUSE_SOFT_DIS_JTAG` is set, the key to re-enable JTAG can be calculated in HMAC module's downstream mode. JTAG is re-enabled when the result configured by the user is the same as the HMAC result.

To re-enable JTAG, users should perform the following steps:

1. Enable the HMAC module by initializing clock and reset signals of HMAC, and enter downstream JTAG enable mode by configuring `HMAC_SET_PARA_PURPOSE_REG`. Then, wait for the calculation to complete. Please see Section 20.2.5 for more details.
2. Write 1 to the `HMAC_SOFT_JTAG_CTRL_REG` register to enter JTAG re-enable compare mode.
3. Write the 256-bit HMAC value to register `HMAC_WR_JTAG_REG`. This value is obtained by performing a local HMAC calculation from the 32-byte 0x00 using SHA-256 and the generated key. It needs to be written by 8 times and 32-bit each time in big-endian word order.
4. If the HMAC result matches the value that users calculated locally, then JTAG is re-enabled. Otherwise, JTAG remains disabled.
5. After writing 1 to `HMAC_SET_INVALIDATE_JTAG_REG` or resetting the chip, JTAG will be disabled. If users want to re-enable JTAG again, please repeat the above steps again.

20.2.3 Downstream Digital Signature Mode

The Digital Signature (DS) module encrypts its parameters using the AES-CBC algorithm. The HMAC module is used as a Key Derivation Function (KDF) to derive the AES key to decrypt these parameters (parameter decryption key). The key used for the HMAC as KDF is stored in one of the eFuse key blocks.

Before starting the DS module, users need to obtain the parameter decryption key for the DS module through HMAC calculation. For more information, please see Chapter 23 *Digital Signature (DS)*. After the chip is powered on, the HMAC module will check whether the key required to calculate the parameter decryption key has been burned in the eFuse block. If the key has been burned, HMAC module will automatically enter the downstream digital signature mode and complete the HMAC calculation based on the chosen key.

20.2.4 HMAC eFuse Configuration

Each HMAC key burned into an eFuse block has a key purpose, specifying for which functionality the key can be used. The HMAC module will not accept a key with a non-matching purpose for any functionality. The HMAC module provides three different functionalities: re-enabling JTAG, DS KDF in downstream mode, and pure HMAC calculation in upstream mode. For each functionality, there exists a corresponding key purpose, listed in Table

20-1. Additionally, another purpose specifies a key which may be used for re-enabling JTAG as well as for serving as DS KDF.

Before enabling HMAC to do calculations, user should make sure the key to be used has been burned in eFuse by reading the registers EFUSE_KEY_PURPOSE_x (We totally have 6 keys in eFuse, so the value of x is 0 ~ 5) from [6 eFuse Controller](#). Take upstream mode as example, if there is no EFUSE_KEY_PURPOSE_HMAC_UP in EFUSE_KEY_PURPOSE_0 ~ 5, it means there is no upstream used key in eFuse. Users can burn key to eFuse as follows:

1. Prepare a secret 256-bit HMAC key and burn the key to an empty eFuse block y . As there are 6 blocks for storing a key in eFuse and the numbers of those blocks range from 4 to 9, the value of y is 4 ~ 9. Hence, when talking about key0, it means eFuse block4. Then, program the purpose to EFUSE_KEY_PURPOSE_ $(y - 4)$. Take upstream mode as an example: after programming the key, the user should program EFUSE_KEY_PURPOSE_HMAC_UP (corresponding value is 6) to EFUSE_KEY_PURPOSE_ $(y - 4)$. Please see Chapter [6 eFuse Controller](#) on how to program eFuse keys.
2. Configure this eFuse key block to be read protected, so that users cannot read its value. A copy of this key should be kept by any party who needs to verify this device.

Please note that the key whose purpose is EFUSE_KEY_PURPOSE_HMAC_DOWN_ALL can be used for both re-enabling JTAG or DS.

Table 20-1. HMAC Purposes and Configuration Value

Purpose	Mode	Value	Description
JTAG Re-enable	Downstream	6	EFUSE_KEY_PURPOSE_HMAC_DOWN_JTAG
DS KDF	Downstream	7	EFUSE_KEY_PURPOSE_HMAC_DOWN_DIGITAL_SIGNATURE
HMAC Calculation	Upstream	8	EFUSE_KEY_PURPOSE_HMAC_UP
Both JTAG Re-enable and DS KDF	Downstream	5	EFUSE_KEY_PURPOSE_HMAC_DOWN_ALL

Configure HMAC Purposes

The correct purpose has to be written to register [HMAC_SET_PARA_PURPOSE_REG](#) (see Section [20.2.5](#)). If there is no valid value in eFuse purpose section, HMAC will terminate calculation.

Select eFuse Key Blocks

The eFuse controller provides six key blocks, i.e., KEY0 ~ 5. To select a particular KEY n for an HMAC calculation, write the key number n to register [HMAC_SET_PARA_KEY_REG](#).

Note that the purpose of the key has also been programmed to eFuse memory. Only when the configured HMAC purpose matches the defined purpose of KEY n , the HMAC module will execute the configured calculation. Otherwise, it will return a matching error and stop the current calculation. For example, suppose a user selects KEY3 for HMAC calculation, and the value programmed to KEY_PURPOSE_3 is 6 (EFUSE_KEY_PURPOSE_HMAC_DOWN_JTAG). Based on [Table 20-1](#), KEY3 can be used to re-enable JTAG. If the value written to register [HMAC_SET_PARA_PURPOSE_REG](#) is also 6, then the HMAC module will start the process to re-enable JTAG.

20.2.5 HMAC Process (Detailed)

The process for users to call HMAC in ESP32-C6 is as follows:

1. Enable HMAC module:
 - (a) Set the peripheral clock bits for HMAC and SHA peripherals in register `SYSTEM_PERIP_CLK_EN1_REG`, and clear the corresponding peripheral reset bits in register `SYSTEM_PERIP_RST_EN1_REG`. For information on those registers, please see Chapter 5 *System and Memory*.
 - (b) Write 1 to register `HMAC_SET_START_REG`.
2. Configure HMAC keys and key purposes:
 - (a) Write the key purpose m to register `HMAC_SET_PARA_PURPOSE_REG`. The possible key purpose values are shown in Table 20-1. For more information, please refer to Section 20.2.4.
 - (b) Select `KEY n` in eFuse memory as the key by writing n (ranges from 0 to 5) to register `HMAC_SET_PARA_KEY_REG`. For more information, please refer to Section 20.2.4.
 - (c) Write 1 to register `HMAC_SET_PARA_FINISH_REG` to complete the configuration.
 - (d) Read register `HMAC_QUERY_ERROR_REG`. If its value is 1, it means the purpose of the selected block does not match the configured key purpose and the calculation will not proceed. If its value is 0, it means the purpose of the selected block matches the configured key purpose, and then the calculation can proceed.
 - (e) When the value of `HMAC_SET_PARA_PURPOSE_REG` is not 8, it means the HMAC module is in downstream mode, proceed with step 3. When the value is 8, it means the HMAC module is in upstream mode, proceed with step 4.
3. Downstream mode:
 - (a) Poll Status register `HMAC_QUERY_BUSY_REG` until it reads 0.
 - (b) To clear the result and make further usage of the dependent hardware (JTAG or DS) impossible, write 1 to either register `HMAC_SET_INVALIDATE_JTAG_REG` to clear the result generated by the JTAG key; or to register `HMAC_SET_INVALIDATE_DS_REG` to clear the result generated by DS key. Afterwards, the HMAC Process needs to be restarted to re-enable any of the dependent peripherals.
4. Transmit message block `Block $_n$` ($n \geq 1$) in upstream mode:
 - (a) Poll Status register `HMAC_QUERY_BUSY_REG` until it reads 0.
 - (b) Write the 512-bit `Block $_n$` to register `HMAC_WDATA0~15_REG`. Write 1 to register `HMAC_SET_MESSAGE_ONE_REG`, to trigger the processing of this message block.
 - (c) Poll Status register `HMAC_QUERY_BUSY_REG` until it reads 0.
 - (d) Different message blocks will be generated, depending on whether the size of the to-be-processed message is a multiple of 512 bits.
 - If the bit length of the message is a multiple of 512 bits, there are three possible options:
 - i. If `Block $_{n+1}$` exists, write 1 to register `HMAC_SET_MESSAGE_ING_REG` to make $n = n + 1$, and then jump to step 4.(b).
 - ii. If `Block $_n$` is the last block of the message and users expects to apply SHA padding in hardware, write 1 to register `HMAC_SET_MESSAGE_END_REG`, and then jump to step 6.

- iii. If Block_n is the last block of the padded message and SHA padding has been applied by users, write 1 to register [HMAC_SET_MESSAGE_PAD_REG](#), and then jump to step 5.
 - If the bit length of the message is not a multiple of 512 bits, there are three possible options as follows. Note that in this case, the user is required to apply SHA padding to the message, after which the padded message length should be a multiple of 512 bits.
 - i. If there is only one message block in total which has included all padding bits, write 1 to register [HMAC_ONE_BLOCK_REG](#), and then jump to step 6.
 - ii. If Block_n is the second last padded block, write 1 to register [HMAC_SET_MESSAGE_PAD_REG](#), and then jump to step 5.
 - iii. If Block_n is neither the last nor the second last message block, write 1 to register [HMAC_SET_MESSAGE_ING_REG](#) and define $n = n + 1$, and then jump to step 4.(b).
5. Apply SHA padding to message:
- (a) Users apply SHA padding to the last message block as described in Section [20.3.1](#), write this block to register [HMAC_WDATA0~15_REG](#), and then write 1 to register [HMAC_SET_MESSAGE_ONE_REG](#). Then the HMAC module will process this message block.
 - (b) Jump to step 6.
6. Read hash result in upstream mode:
- (a) Poll Status register [HMAC_QUERY_BUSY_REG](#) until it reads 0.
 - (b) Read hash result from register [HMAC_RDATA0~7_REG](#).
 - (c) Write 1 to register [HMAC_SET_RESULT_FINISH_REG](#) to finish calculation. The result will be cleared at the same time.
 - (d) Upstream mode operation is completed.

Note:

The SHA accelerator can be called directly, or used internally by the DS module and the HMAC module. However, they can not share the hardware resources simultaneously. Therefore, the SHA module must not be called neither by the CPU nor by the DS module when the HMAC module is in use.

20.3 HMAC Algorithm Details

20.3.1 Padding Bits

The HMAC module uses SHA-256 as hash algorithm. If the input message is not a multiple of 512 bits, the user must apply a SHA-256 padding algorithm in software. The SHA-256 padding algorithm is the same as described in Section *Padding the Message* of [FIPS PUB 180-4](#). In downstream mode, users do not need to input any message or apply padding. The HMAC module uses a default 32-byte pattern of 0x00 for re-enabling JTAG and a 32-byte pattern of 0xff for deriving the AES key for the DS module.

As shown in Figure [20-1](#), suppose the length of the unpadded message is m bits. Padding steps are as follows:

1. Append one bit of value “1” to the end of the unpadded message.

2. Append k bits of value "0", where k is the smallest non-negative number which satisfies $m + 1 + k \equiv 448 \pmod{512}$.
3. Append a 64-bit integer value as a binary block. This block consists of the length of the unpadded message as a big-endian binary integer value m .

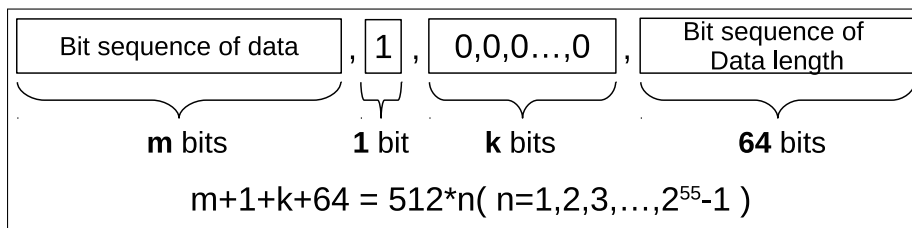

Figure 20-1. HMAC SHA-256 Padding Diagram

In upstream mode, if the length of the unpadded message is a multiple of 512 bits, users can configure hardware to apply SHA padding by writing 1 to `HMAC_SET_MESSGAE_END_REG` or do padding work themselves by writing 1 to `HMAC_SET_MESSAGE_PAD_REG`. If the length is not a multiple of 512 bits, SHA padding must be manually applied by the user. After the user prepared the padding data, they should complete the subsequent configuration according to the Section 20.2.5.

20.3.2 HMAC Algorithm Structure

The structure of the implemented algorithm in the HMAC module is shown in Figure 20-2. This is the standard HMAC algorithm as described in RFC 2104.

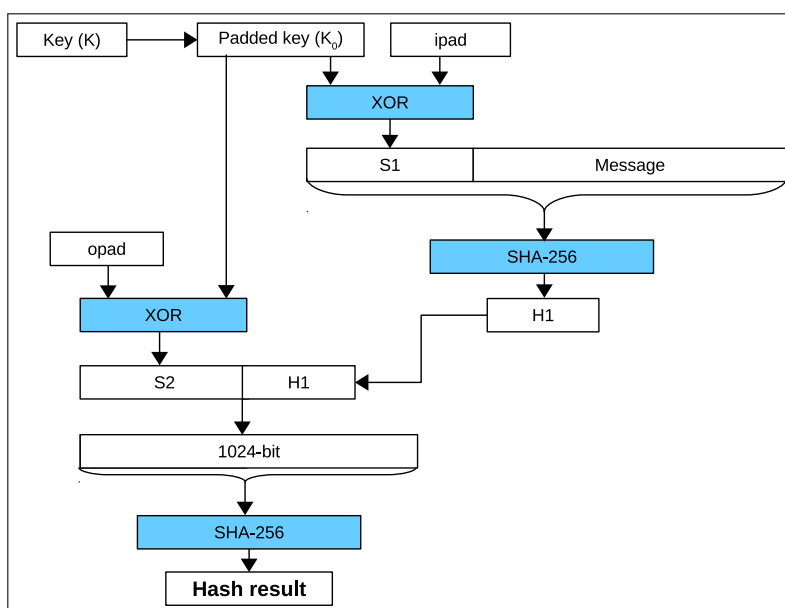

Figure 20-2. HMAC Structure Schematic Diagram

In Figure 20-2:

1. ipad is a 512-bit message block composed of 64 bytes of 0x36.
2. opad is a 512-bit message block composed of 64 bytes of 0x5c.

The HMAC module appends a 256-bit 0 sequence after the bit sequence of the 256-bit key K in order to get a 512-bit K_0 . Then, the HMAC module XORs K_0 with ipad to get the 512-bit S1. Afterwards, the HMAC module appends the input message (multiple of 512 bits) after the 512-bit S1, and exercises the SHA-256 algorithm to get the 256-bit H1.

The HMAC module appends the 256-bit SHA-256 hash result H1 to the 512-bit S2 value, which is calculated using the XOR operation of K_0 and opad. A 768-bit sequence will be generated. Then, the HMAC module uses the SHA padding algorithm described in Section 20.3.1 to pad the 768-bit sequence to a 1024-bit sequence, and applies the SHA-256 algorithm to get the final hash result (256-bit).

20.4 Register Summary

The addresses in this section are relative to HMAC Accelerator base address provided in Table 5-2 in Chapter 5 *System and Memory*.

The abbreviations given in Column **Access** are explained in Section *Access Types for Registers*.

Name	Description	Address	Access
Control/Status Registers			
HMAC_SET_START_REG	HMAC start control register	0x0040	WO
HMAC_SET_PARA_FINISH_REG	HMAC configuration completion register	0x004C	WO
HMAC_SET_MESSAGE_ONE_REG	HMAC message control register	0x0050	WO
HMAC_SET_MESSAGE_ING_REG	HMAC message continue register	0x0054	WO
HMAC_SET_MESSAGE_END_REG	HMAC message end register	0x0058	WO
HMAC_SET_RESULT_FINISH_REG	HMAC result reading finish register	0x005C	WO
HMAC_SET_INVALIDATE_JTAG_REG	Invalidate JTAG result register	0x0060	WO
HMAC_SET_INVALIDATE_DS_REG	Invalidate digital signature result register	0x0064	WO
HMAC_QUERY_ERROR_REG	Stores matching results between keys generated by users and corresponding purposes	0x0068	RO
HMAC_QUERY_BUSY_REG	Busy state of HMAC module	0x006C	RO
HMAC_SET_MESSAGE_PAD_REG	Software padding register	0x00F0	WO
HMAC_ONE_BLOCK_REG	One block message register	0x00F4	WO
Configuration Registers			
HMAC_SET_PARA_PURPOSE_REG	HMAC parameter configuration register	0x0044	WO
HMAC_SET_PARA_KEY_REG	HMAC parameters configuration register	0x0048	WO
HMAC_SOFT_JTAG_CTRL_REG	Re-enable JTAG register 0	0x00F8	WO
HMAC_WR_JTAG_REG	Re-enable JTAG register 1	0x00FC	WO
HMAC Message Block			
HMAC_WR_MESSAGE_0_REG	Message register 0	0x0080	WO
HMAC_WR_MESSAGE_1_REG	Message register 1	0x0084	WO
HMAC_WR_MESSAGE_2_REG	Message register 2	0x0088	WO
HMAC_WR_MESSAGE_3_REG	Message register 3	0x008C	WO
HMAC_WR_MESSAGE_4_REG	Message register 4	0x0090	WO
HMAC_WR_MESSAGE_5_REG	Message register 5	0x0094	WO
HMAC_WR_MESSAGE_6_REG	Message register 6	0x0098	WO
HMAC_WR_MESSAGE_7_REG	Message register 7	0x009C	WO
HMAC_WR_MESSAGE_8_REG	Message register 8	0x00A0	WO
HMAC_WR_MESSAGE_9_REG	Message register 9	0x00A4	WO
HMAC_WR_MESSAGE_10_REG	Message register 10	0x00A8	WO
HMAC_WR_MESSAGE_11_REG	Message register 11	0x00AC	WO
HMAC_WR_MESSAGE_12_REG	Message register 12	0x00B0	WO
HMAC_WR_MESSAGE_13_REG	Message register 13	0x00B4	WO
HMAC_WR_MESSAGE_14_REG	Message register 14	0x00B8	WO
HMAC_WR_MESSAGE_15_REG	Message register 15	0x00BC	WO
HMAC Upstream Result			
HMAC_RD_RESULT_0_REG	Hash result register 0	0x00C0	RO

Name	Description	Address	Access
HMAC_RD_RESULT_1_REG	Hash result register 1	0x00C4	RO
HMAC_RD_RESULT_2_REG	Hash result register 2	0x00C8	RO
HMAC_RD_RESULT_3_REG	Hash result register 3	0x00CC	RO
HMAC_RD_RESULT_4_REG	Hash result register 4	0x00D0	RO
HMAC_RD_RESULT_5_REG	Hash result register 5	0x00D4	RO
HMAC_RD_RESULT_6_REG	Hash result register 6	0x00D8	RO
HMAC_RD_RESULT_7_REG	Hash result register 7	0x00DC	RO
Version Register			
HMAC_DATE_REG	Version control register	0x00F8	R/W

20.5 Registers

The addresses in this section are relative to HMAC Accelerator base address provided in Table 5-2 in Chapter 5 *System and Memory*.

Register 20.1. HMAC_SET_START_REG (0x0040)

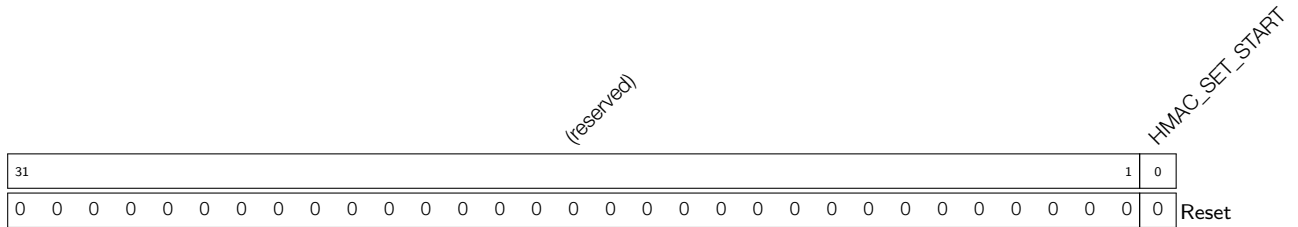

HMAC_SET_START Configures whether or not to enable HMAC.
 0: Disable HMAC
 1: Enable HMAC
 (WO)

Register 20.2. HMAC_SET_PARA_FINISH_REG (0x004C)

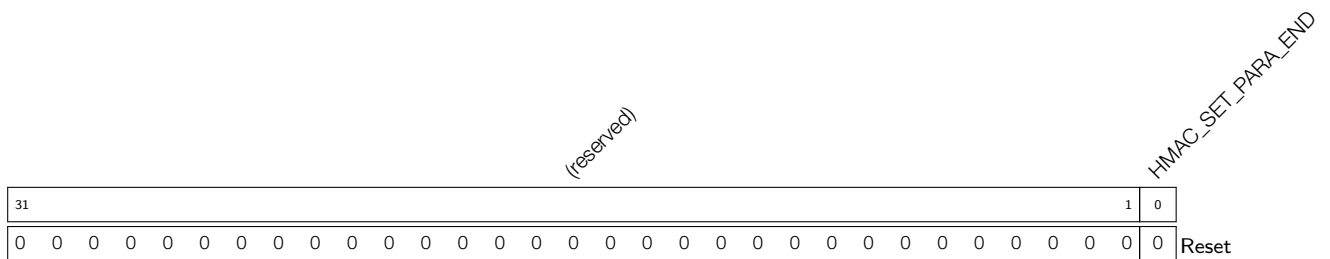

HMAC_SET_PARA_FINISH Configures whether to finish HMAC configuration.
 0: No effect
 1: Finish configuration
 (WO)

Register 20.3. HMAC_SET_MESSAGE_CALC_BLOCK_REG (0x0050)

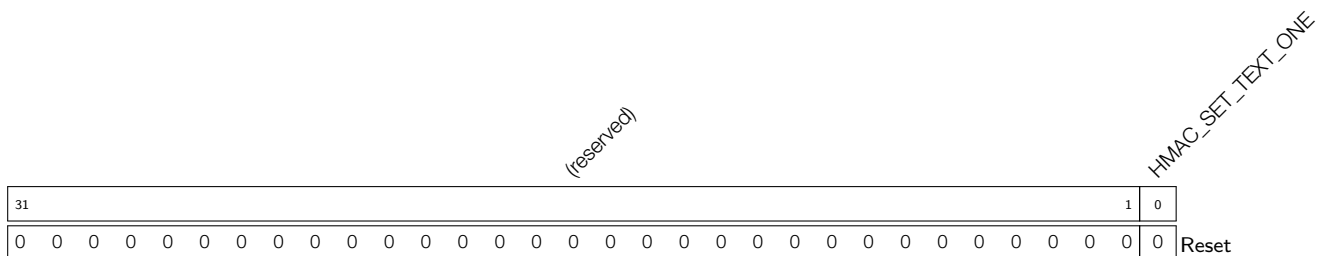

HMAC_SET_MESSAGE_CALC_BLOCK Calls SHA to calculate one message block. (WO)

Register 20.4. HMAC_SET_MESSAGE_ING_REG (0x0054)

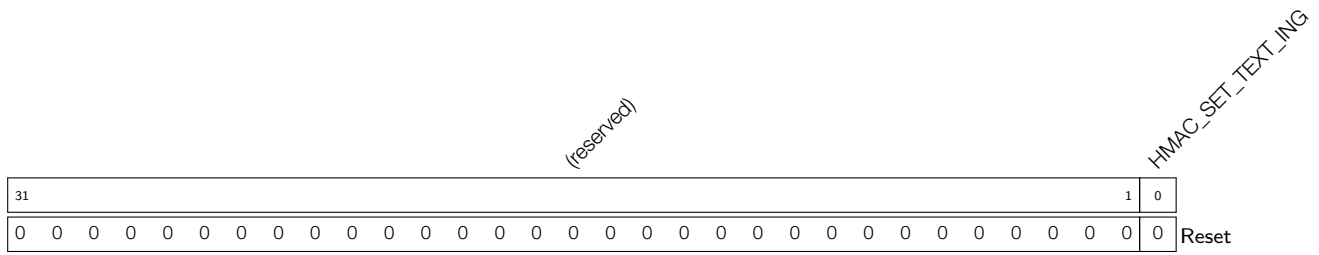

HMAC_SET_TEXT_ING Configures whether or not there are unprocessed message blocks.

- 0: No unprocessed message block
 - 1: There are still some message blocks to be processed.
- (WO)

Register 20.5. HMAC_SET_MESSAGE_END_REG (0x0058)

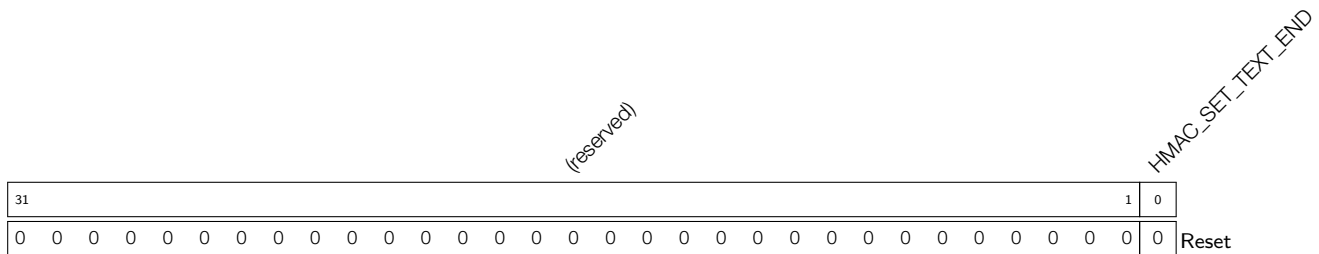

HMAC_SET_TEXT_END Configures whether to start hardware padding.

- 0: No effect
 - 1: Start hardware padding
- (WO)

Register 20.6. HMAC_SET_RESULT_FINISH_REG (0x005C)

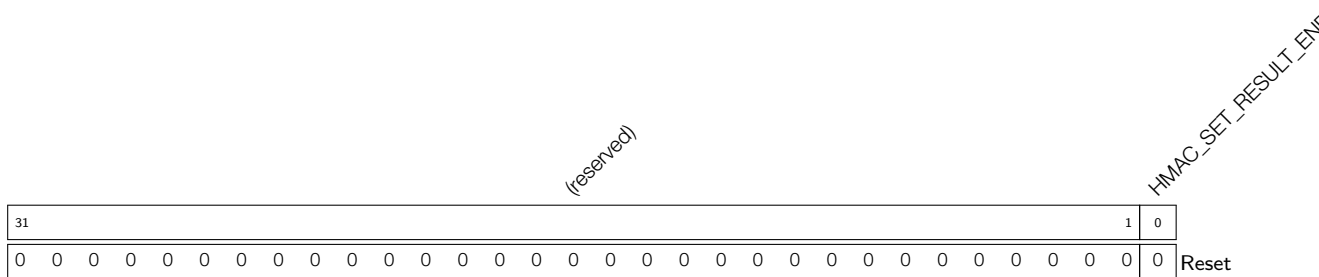

HMAC_SET_RESULT_END Configures whether to exit upstream mode and clear calculation results.

- 0: Not exit
 - 1: Exit upstream mode and clear calculation results.
- (WO)

Register 20.7. HMAC_SET_INVALIDATE_JTAG_REG (0x0060)

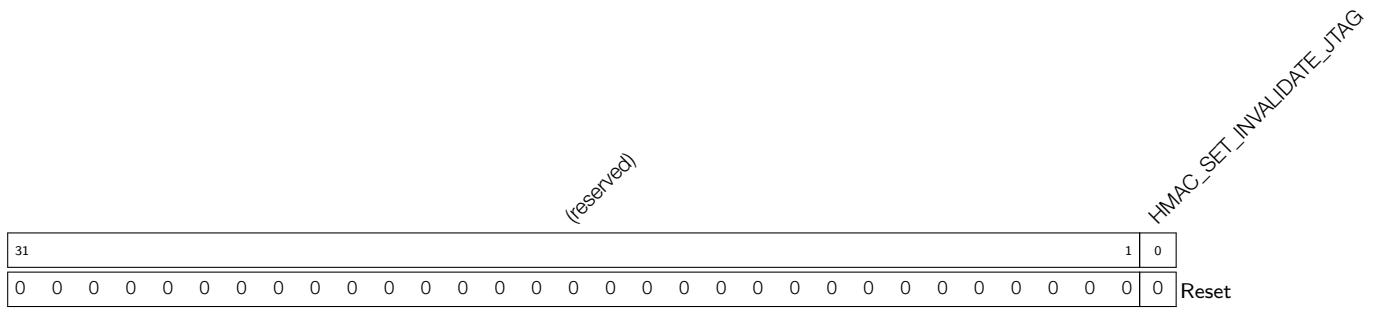

HMAC_SET_INVALIDATE_JTAG Configures whether or not to clear calculation results when re-enabling JTAG in downstream mode.

- 0: Not clear
- 1: Clear calculation results (WO)

Register 20.8. HMAC_SET_INVALIDATE_DS_REG (0x0064)

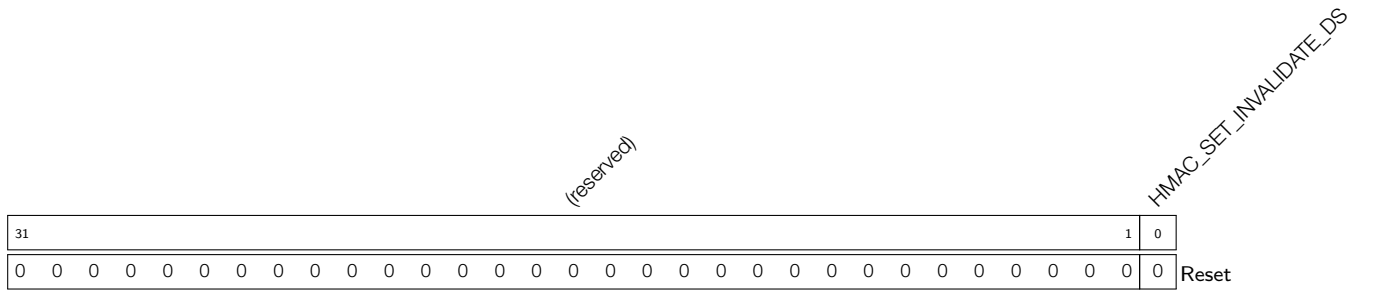

HMAC_SET_INVALIDATE_DS Configures whether or not to clear calculation results of the DS module in downstream mode.

- 0: Not clear
- 1: Clear calculation results (WO)

Register 20.9. HMAC_QUERY_ERROR_REG (0x0068)

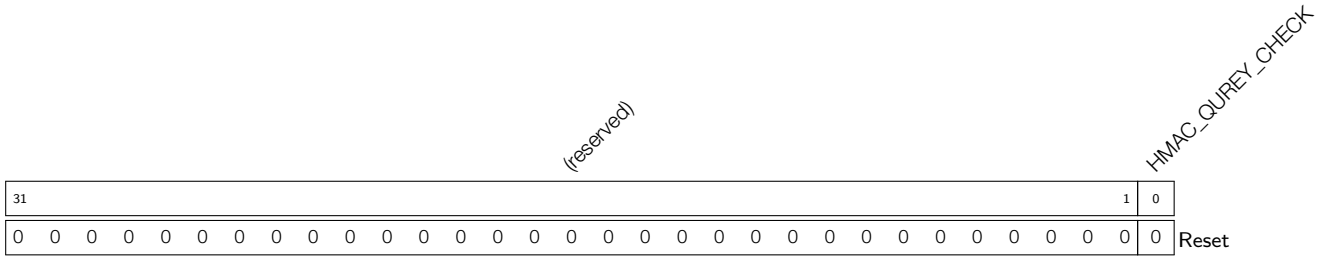

HMAC_QUERY_CHECK Represents whether or not an HMAC key matches the purpose.

0: Match

1: Error

(RO)

Register 20.10. HMAC_QUERY_BUSY_REG (0x006C)

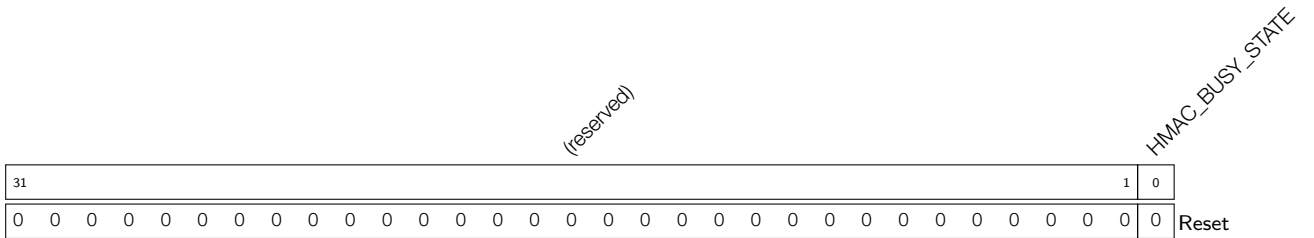

HMAC_BUSY_STATE Represents whether or not HMAC is in a busy state. Before configuring HMAC, please make sure HMAC is in an IDLE state.

0: Idle

1: HMAC is still working on the calculation

(RO)

Register 20.11. HMAC_SET_PARA_PURPOSE_REG (0x0044)

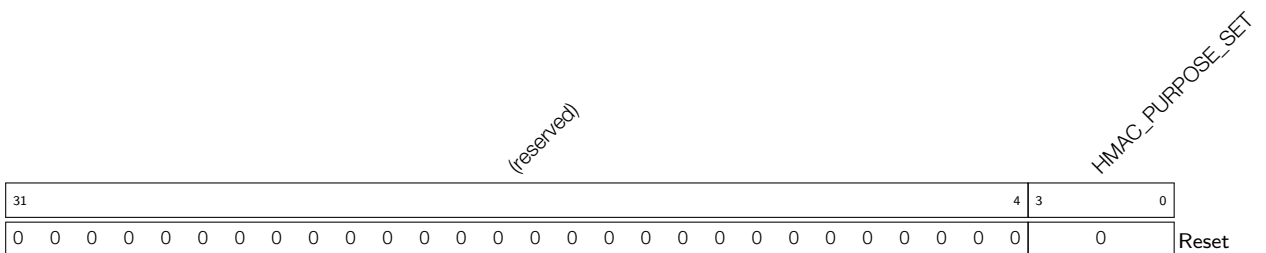

HMAC_PURPOSE_SET Configures the HMAC purpose, refer to the Table 20-1. (WO)

Register 20.12. HMAC_SET_PARA_KEY_REG (0x0048)

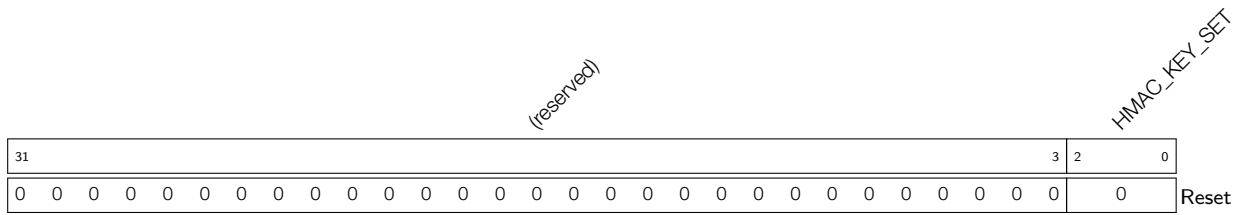

HMAC_KEY_SET Configures HMAC key. There are six keys with index 0~5. Write the index of the selected key to this field. (WO)

Register 20.13. HMAC_WR_MESSAGE_n_REG (n: 0-15) (0x0080+4*n)

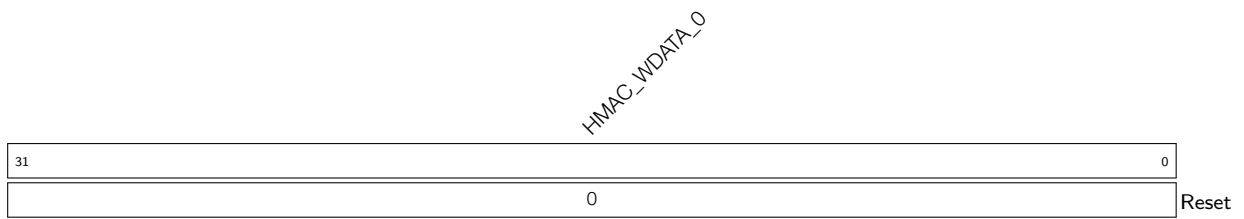

HMAC_WDATA_n Represents the *n*th 32-bit of message. (WO)

Register 20.14. HMAC_RD_RESULT_n_REG (n: 0-7) (0x00C0+4*n)

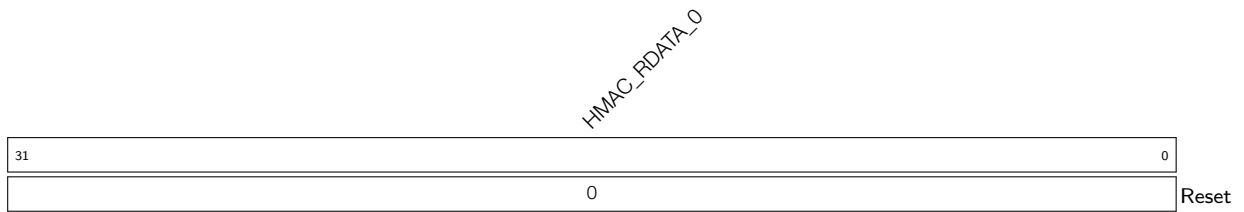

HMAC_RDATA_n Represents the *n*th 32-bit of hash result. (RO)

Register 20.15. HMAC_SET_MESSAGE_PAD_REG (0x00F0)

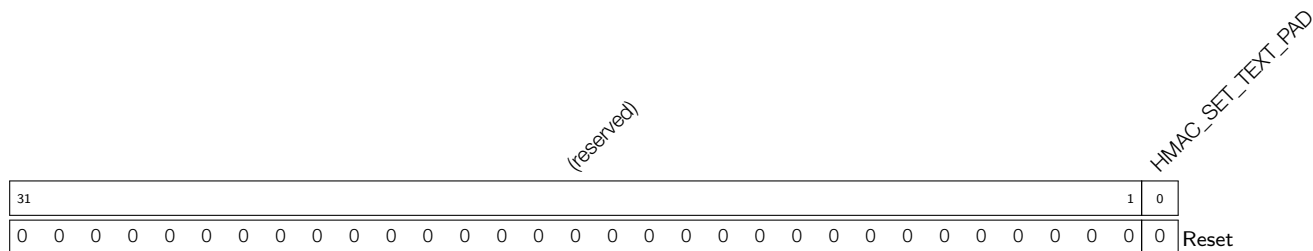

HMAC_SET_TEXT_PAD Configures whether or not the padding is applied by software.

- 0: Not applied by software
 - 1: Applied by software
- (WO)

Register 20.16. HMAC_ONE_BLOCK_REG (0x00F4)

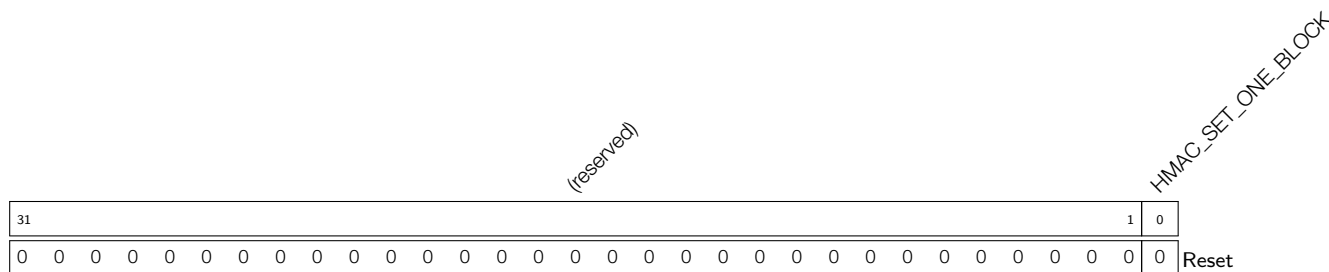

HMAC_SET_ONE_BLOCK Write 1 to indicate there is only one block which already contains padding bits and there is no need for padding. (WO)

Register 20.17. HMAC_SOFT_JTAG_CTRL_REG (0x00F8)

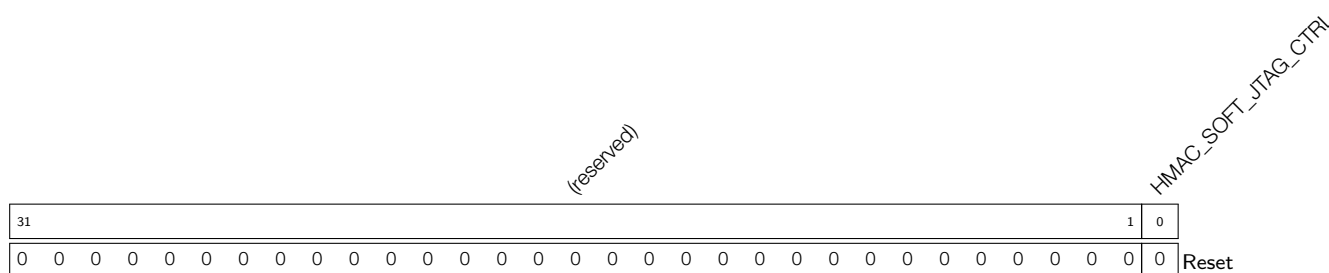

HMAC_SOFT_JTAG_CTRL Configures whether or not to enable JTAG authentication mode.

- 0: Disable
 - 1: Enable
- (WO)

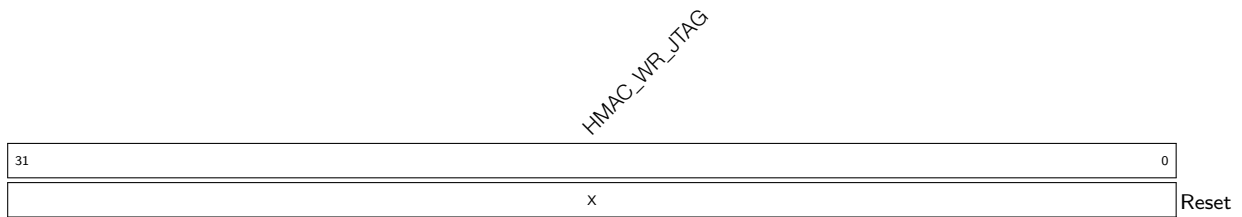
Register 20.18. HMAC_WR_JTAG_REG (0x00FC)

HMAC_WR_JTAG Writes the comparing input used for re-enabling JTAG. (WO)

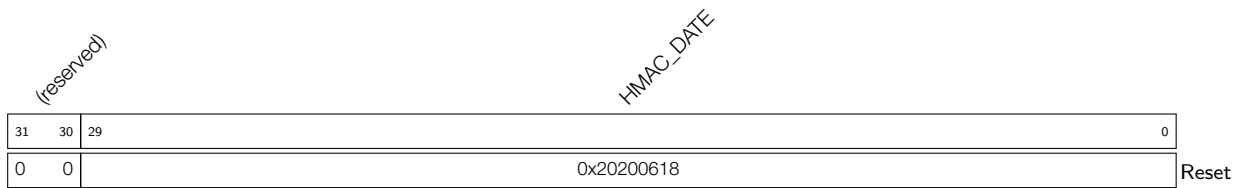
Register 20.19. HMAC_DATE_REG (0x00F8)

HMAC_DATE Version control register. (R/W)

21 RSA Accelerator (RSA)

21.1 Introduction

The RSA accelerator provides hardware support for high-precision computation used in various RSA asymmetric cipher algorithms, significantly improving their run time and reducing their software complexity. Compared with RSA algorithms implemented solely in software, this hardware accelerator can speed up RSA algorithms significantly. The RSA accelerator also supports operands of different lengths, which provides more flexibility during the computation.

21.2 Features

The following functionality is supported:

- Large-number modular exponentiation with two optional acceleration options
- Large-number modular multiplication
- Large-number multiplication
- Operands of different lengths
- Interrupt on completion of computation

21.3 Functional Description

The RSA accelerator is activated by setting the [PCR_RSA_CLK_EN](#) bit and clearing the [PCR_RSA_RST_EN](#) bit in the [PCR_RSA_CONF_REG](#) register. Additionally, users also need to clear [PCR_DS_RST_EN](#) bit to reset [Digital Signature \(DS\)](#).

The RSA accelerator is only available after the [RSA-related memories](#) are initialized. The content of the [RSA_QUERY_CLEAN_REG](#) register is 0 during initialization and will become 1 after the initialization is done. Therefore, wait until [RSA_QUERY_CLEAN_REG](#) becomes 1 before using the RSA accelerator.

The [RSA_INT_ENA_REG](#) register is used to control the interrupt triggered on completion of computation. Write 1 or 0 to this field to enable or disable the interrupt. By default, the interrupt function of the RSA accelerator is enabled.

Notice:

ESP32-C6's [Digital Signature \(DS\)](#) module also calls the RSA accelerator when working. Therefore, users cannot access the RSA accelerator when the [Digital Signature \(DS\)](#) module is working.

21.3.1 Large-number Modular Exponentiation

Large-number modular exponentiation performs $Z = X^Y \bmod M$. The computation is based on Montgomery multiplication. Therefore, aside from the X , Y , and M arguments, two additional ones are needed — \bar{r} and M' , which need to be calculated in advance by software.

The RSA accelerator supports operands of length $N = 32 \times x$, where $x \in \{1, 2, 3, \dots, 96\}$. The bit lengths of arguments Z , X , Y , M , and \bar{r} can be arbitrary N , but all numbers in a calculation must be of the same length.

The bit length of M' must be 32.

To represent the numbers used as operands, let us define a base- b positional notation, as follows:

$$b = 2^{32}$$

Using this notation, each number is represented by a sequence of base- b digits:

$$n = \frac{N}{32}$$

$$Z = (Z_{n-1}Z_{n-2} \cdots Z_0)_b$$

$$X = (X_{n-1}X_{n-2} \cdots X_0)_b$$

$$Y = (Y_{n-1}Y_{n-2} \cdots Y_0)_b$$

$$M = (M_{n-1}M_{n-2} \cdots M_0)_b$$

$$\bar{r} = (\bar{r}_{n-1}\bar{r}_{n-2} \cdots \bar{r}_0)_b$$

Each of the values in $Z_{n-1} \cdots Z_0$, $X_{n-1} \cdots X_0$, $Y_{n-1} \cdots Y_0$, $M_{n-1} \cdots M_0$, $\bar{r}_{n-1} \cdots \bar{r}_0$ represents one base- b digit (a 32-bit word).

Z_{n-1} , X_{n-1} , Y_{n-1} , M_{n-1} and \bar{r}_{n-1} are the most significant bits of Z , X , Y , M , while Z_0 , X_0 , Y_0 , M_0 and \bar{r}_0 are the least significant bits.

If we define $R = b^n$, the additional argument \bar{r} can be calculated as $\bar{r} = R^2 \bmod M$.

Also, argument M' can be calculated using the formula below:

$$M' = -M^{-1} \bmod b$$

where, M^{-1} is the [modular multiplicative inverse](#) of M , and it can be calculated with the extended binary GCD algorithm.

Large-number modular exponentiation on the ESP32-C6 can be implemented as follows:

1. Write 1 or 0 to the [RSA_INT_ENA](#) field to enable or disable the interrupt function.
2. Configure relevant registers:
 - (a) Write $(\frac{N}{32} - 1)$ to the [RSA_MODE_REG](#) register.
 - (b) Write M' to the [RSA_M_PRIME_REG](#) register.
 - (c) Configure registers related to the acceleration options, which are described later in Section 21.3.4.
3. Write X_i , Y_i , M_i and \bar{r}_i for $i \in \{0, 1, \dots, n - 1\}$ to memory blocks [RSA_X_MEM](#), [RSA_Y_MEM](#), [RSA_M_MEM](#) and [RSA_Z_MEM](#). The capacity of each memory block is 96 words. Each word of each memory block can store one base- b digit. The memory blocks use the little endian format for storage, i.e. the least significant digit of each number is in the lowest address.

Users need to write data to each memory block only according to the length of the number; data beyond this length is ignored.

4. Write 1 to the [RSA_SET_START_MODEXP](#) field of the [RSA_SET_START_MODEXP_REG](#) register to start computation.
5. Wait for the completion of computation, which happens when the content of [RSA_QUERY_IDLE](#) becomes 1 or the RSA interrupt occurs.

6. Read the result Z_i for $i \in \{0, 1, \dots, n - 1\}$ from [RSA_Z_MEM](#).
7. Write 1 to [RSA_CLEAR_INTERRUPT](#) to clear the interrupt, if you have the interrupt enabled.

After the computation, the [RSA_MODE_REG](#) register, memory blocks [RSA_Y_MEM](#) and [RSA_M_MEM](#), as well as the [RSA_M_PRIME_REG](#) remain unchanged. However, X_i in [RSA_X_MEM](#) and \bar{r}_i in [RSA_Z_MEM](#) computation are overwritten, and only these overwritten memory blocks need to be re-initialized before starting another computation.

21.3.2 Large-number Modular Multiplication

Large-number modular multiplication performs $Z = X \times Y \bmod M$. This computation is based on Montgomery multiplication. Therefore, similar to the large-number modular exponentiation, two additional arguments are needed – \bar{r} and M' , which need to be calculated in advance by software.

The RSA accelerator supports large-number modular multiplication with operands of 96 different lengths.

The computation can be executed as follows:

1. Write 1 or 0 to the [RSA_INT_ENA_REG](#) register to enable or disable the interrupt function.
2. Configure relevant registers:
 - (a) Write $(\frac{N}{32} - 1)$ to the [RSA_MODE_REG](#) register.
 - (b) Write M' to the [RSA_M_PRIME_REG](#) register.
3. Write X_i , Y_i , M_i , and \bar{r}_i for $i \in \{0, 1, \dots, n - 1\}$ to memory blocks [RSA_X_MEM](#), [RSA_Y_MEM](#), [RSA_M_MEM](#), and [RSA_Z_MEM](#), respectively. The capacity of each memory block is 96 words. Each word of each memory block can store one base- b digit. The memory blocks use the little endian format for storage, i.e., the least significant digit of each number is in the lowest address.

Users need to write data to each memory block only according to the length of the number; data beyond this length are ignored.

4. Write 1 to the [RSA_SET_START_MODMULT](#) field.
5. Wait for the completion of computation, which happens when the content of [RSA_QUERY_IDLE](#) becomes 1 or the RSA interrupt occurs.
6. Read the result Z_i for $i \in \{0, 1, \dots, n - 1\}$ from [RSA_Z_MEM](#).
7. Write 1 to [RSA_CLEAR_INTERRUPT](#) to clear the interrupt, if you have the interrupt enabled.

After the computation, the length of operands in [RSA_MODE_REG](#), the X_i in memory [RSA_X_MEM](#), the Y_i in memory [RSA_Y_MEM](#), the M_i in memory [RSA_M_MEM](#), and the M' in memory [RSA_M_PRIME_REG](#) remain unchanged. However, the \bar{r}_i in memory [RSA_Z_MEM](#) has already been overwritten, and only this overwritten memory block needs to be re-initialized before starting another computation.

21.3.3 Large-number Multiplication

Large-number multiplication performs $Z = X \times Y$. The length of result Z is twice that of operand X and operand Y . Therefore, the RSA accelerator only supports large-number multiplication with operand length $N = 32 \times x$, where $x \in \{1, 2, 3, \dots, 48\}$. The length \hat{N} of result Z is $2 \times N$.

The computation can be executed as follows:

1. Write 1 or 0 to the [RSA_INT_ENA_REG](#) register to enable or disable the interrupt function.
2. Write $(\frac{\hat{N}}{32} - 1)$, i.e. $(\frac{N}{16} - 1)$ to the [RSA_MODE_REG](#) register.
3. Write X_i and Y_i for $i \in \{0, 1, \dots, n - 1\}$ to memory blocks [RSA_X_MEM](#) and [RSA_Z_MEM](#). Each word of each memory block can store one base- b digit. The memory blocks use the little endian format for storage, i.e. the least significant digit of each number is in the lowest address. n is $\frac{N}{32}$.

Write X_i for $i \in \{0, 1, \dots, n - 1\}$ to the address of the i words of the [RSA_X_MEM](#) memory block. Note that Y_i for $i \in \{0, 1, \dots, n - 1\}$ will not be written to the address of the i words of the [RSA_Z_MEM](#) register, but the address of the $n + i$ words, i.e. the base address of the [RSA_Z_MEM](#) memory plus the address offset $4 \times (n + i)$.

Users need to write data to each memory block only according to the length of the number; data beyond this length is ignored.

4. Write 1 to the [RSA_SET_START_MULT](#) register.
5. Wait for the completion of computation, which happens when the content of [RSA_QUERY_IDLE](#) becomes 1 or the RSA interrupt occurs.
6. Read the result Z_i for $i \in \{0, 1, \dots, \hat{n} - 1\}$ from the [RSA_Z_MEM](#) register. \hat{n} is $2 \times n$.
7. Write 1 to [RSA_CLEAR_INTERRUPT](#) to clear the interrupt, if you have the interrupt enabled.

After the computation, the length of operands in [RSA_MODE_REG](#) and the X_i in memory [RSA_X_MEM](#) remain unchanged. However, the Y_i in memory [RSA_Z_MEM](#) has already been overwritten, and only this overwritten memory block needs to be re-initialized before starting another computation.

21.3.4 Options for Additional Acceleration

The ESP32-C6 RSA accelerator also provides [SEARCH](#) and [CONSTANT_TIME](#) options that can be configured to further accelerate the large-number modular exponentiation. By default, both options are configured as no additional acceleration.

Users can choose to use one or two of these options to further accelerate the computation. Note that, even when none of these two options is configured, using the hardware RSA accelerator is still much faster than implementing the RSA algorithm in software.

To be more specific, when neither of these two options are configured for additional acceleration, the time required to calculate $Z = X^Y \bmod M$ is solely determined by the lengths of operands. When either or both of these two options are configured for additional acceleration, the time required is also correlated with the 0/1 distribution of Y .

To better illustrate how these two options work, first assume Y is represented in binaries as

$$Y = (\tilde{Y}_{N-1}\tilde{Y}_{N-2}\cdots\tilde{Y}_{t+1}\tilde{Y}_t\tilde{Y}_{t-1}\cdots\tilde{Y}_0)_2$$

where,

- N is the length of Y ,
- \tilde{Y}_t is 1,

- $\tilde{Y}_{N-1}, \tilde{Y}_{N-2}, \dots, \tilde{Y}_{t+1}$ are all equal to 0,
- and $\tilde{Y}_{t-1}, \tilde{Y}_{t-2}, \dots, \tilde{Y}_0$ are either 0 or 1 but exactly m bits should be equal to 0 and $t-m$ bits 1, i.e. the Hamming weight of $\tilde{Y}_{t-1}\tilde{Y}_{t-2}, \dots, \tilde{Y}_0$ is $t - m$.

When either of these two options is configured for additional acceleration:

- SEARCH Option (Configuring [RSA_SEARCH_ENABLE](#) to 1 for additional acceleration)
 - The accelerator ignores the bit positions of \tilde{Y}_i , where $i > \alpha$. Search position α is set by configuring the [RSA_SEARCH_POS_REG](#) register. Set α to a number smaller than $N-1$, which otherwise leads to the same result as if this option is not used for additional acceleration. The best acceleration performance can be achieved by setting α to t , in which case all the $\tilde{Y}_{N-1}, \tilde{Y}_{N-2}, \dots, \tilde{Y}_{t+1}$ of 0s are ignored during the calculation. Note that if you set α to be less than t , then the result of the modular exponentiation $Z = X^Y \bmod M$ will be incorrect.
 - Note that this option compromises the security because it ignores some bits, which essentially shortens the key length, thus should not be enabled for applications with high security requirement.
- CONSTANT_TIME Option (Configuring [RSA_CONSTANT_TIME_REG](#) to 0 for additional acceleration)
 - The accelerator speeds up the calculation by simplifying the calculation concerning the 0 bits of Y . Therefore, the higher the proportion of bits 0 against bits 1, the better is the acceleration performance.
 - Note that this option also compromises the security because its time cost correlates with the 0/1 distribution of the key, which can be used in a Side Channel Attack (SCA), thus should not be enabled for applications with high security requirement.

Below is an example to demonstrate the performance of the RSA accelerator under different combinations of [SEARCH](#) and [CONSTANT_TIME](#) configuration. Here we perform $Z = X^Y \bmod M$ with $N = 3072$ and $Y = 65537$. Table 21-1 below demonstrates the time costs under different combinations of [SEARCH](#) and [CONSTANT_TIME](#) configuration. Here, we should also mention that, α is set to 16 when the SEARCH option is enabled.

Table 21-1. Acceleration Performance

SEARCH Option	CONSTANT_TIME Option	Time Cost (ms)
No acceleration	No acceleration	752.81
Accelerated	No acceleration	4.52
No acceleration	Acceleration	2.41
Acceleration	Acceleration	2.33

It is obvious that:

- The time cost is biggest when none of these two options is configured for additional acceleration.
- The time cost is smallest when both of these two options are configured for additional acceleration.
- The time cost can be dramatically reduced when either or both option(s) are configured for additional acceleration.

21.4 Memory Summary

The addresses in this section are relative to the RSA accelerator base address provided in Table 5-2 in Chapter 5 *System and Memory*.

The abbreviations given in Column **Access** are explained in Section *Access Types for Registers*.

Table 21-2. RSA Accelerator Memory Blocks

Name	Description	Size (byte)	Starting Address	Ending Address	Access
RSA_M_MEM	Memory M	384	0x0000	0x017F	R/W
RSA_Z_MEM	Memory Z	384	0x0200	0x037F	R/W
RSA_Y_MEM	Memory Y	384	0x0400	0x057F	R/W
RSA_X_MEM	Memory X	384	0x0600	0x077F	R/W

21.5 Register Summary

The addresses in this section are relative to the RSA accelerator base address provided in Table 5-2 in Chapter 5 *System and Memory*.

The abbreviations given in Column **Access** are explained in Section *Access Types for Registers*.

Name	Description	Address	Access
Control / Configuration Registers			
RSA_M_PRIME_REG	Represents M'	0x0800	R/W
RSA_MODE_REG	Configures RSA length	0x0804	R/W
RSA_SET_START_MODEXP_REG	Starts modular exponentiation	0x080C	WT
RSA_SET_START_MODMULT_REG	Starts modular multiplication	0x0810	WT
RSA_SET_START_MULT_REG	Starts multiplication	0x0814	WT
RSA_QUERY_IDLE_REG	Represents the RSA status	0x0818	RO
RSA_CONSTANT_TIME_REG	Configures the constant_time option	0x0820	R/W
RSA_SEARCH_ENABLE_REG	Configures the search option	0x0824	R/W
RSA_SEARCH_POS_REG	Configures the search position	0x0828	R/W
Status Register			
RSA_QUERY_CLEAN_REG	RSA initialization status	0x0808	RO
Interrupt Registers			
RSA_INT_CLR_REG	Clears RSA interrupt	0x081C	WT
RSA_INT_ENA_REG	Enables the RSA interrupt	0x082C	R/W
Version Control Register			
RSA_DATE_REG	Version control register	0x0830	R/W

21.6 Registers

The addresses in this section are relative to the RSA accelerator base address provided in Table 5-2 in Chapter 5 *System and Memory*.

Register 21.1. RSA_M_PRIME_REG (0x0800)

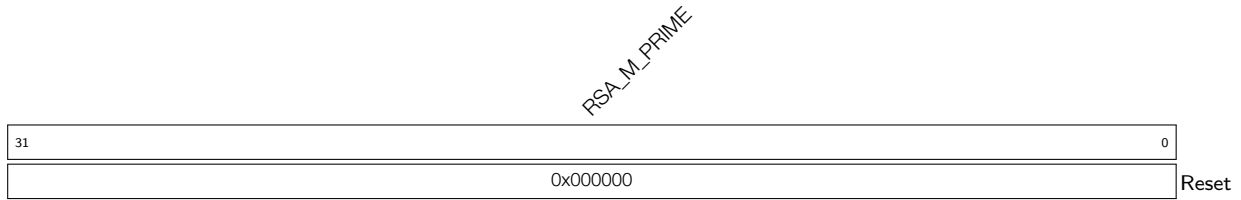

RSA_M_PRIME Represents M' . (R/W)

Register 21.2. RSA_MODE_REG (0x0804)

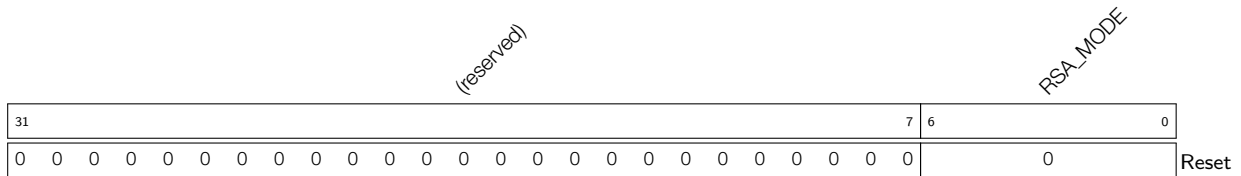

RSA_MODE Configures the RSA length. (R/W)

Register 21.3. RSA_SET_START_MODEXP_REG (0x080C)

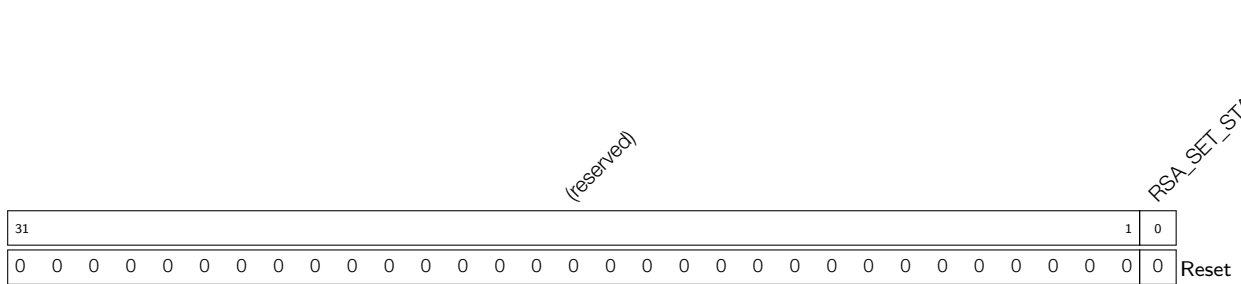

RSA_SET_START_MODEXP Configures whether or not to starts the modular exponentiation.

0: No effect

1: Start

(WT)

Register 21.4. RSA_SET_START_MODMULT_REG (0x0810)

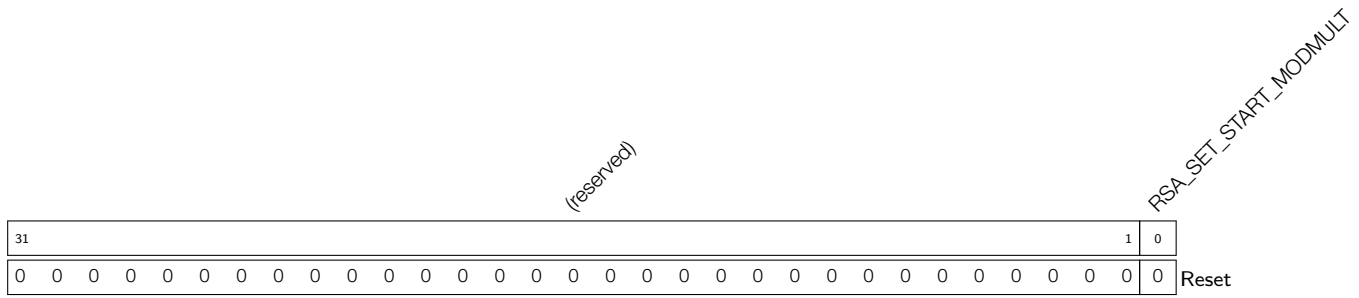

RSA_SET_START_MODMULT Configures whether or not to start the modular multiplication.

- 0: No effect
 - 1: Start
- (WT)

Register 21.5. RSA_SET_START_MULT_REG (0x0814)

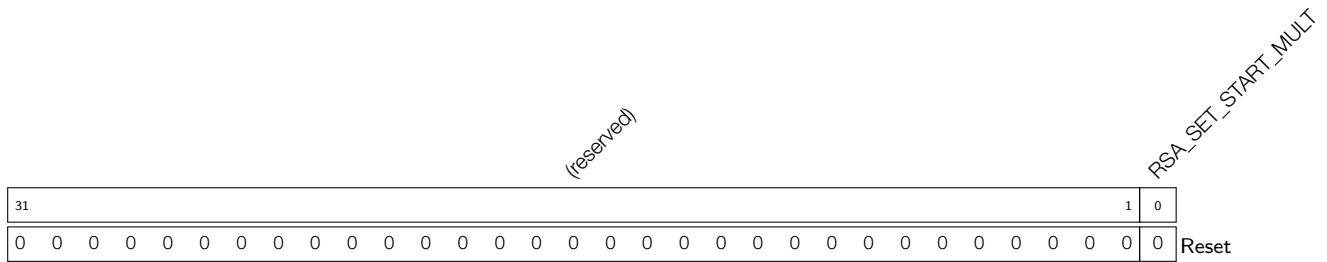

RSA_SET_START_MULT Configures whether or not to start the multiplication.

- 0: No effect
 - 1: Start
- (WT)

Register 21.6. RSA_QUERY_IDLE_REG (0x0818)

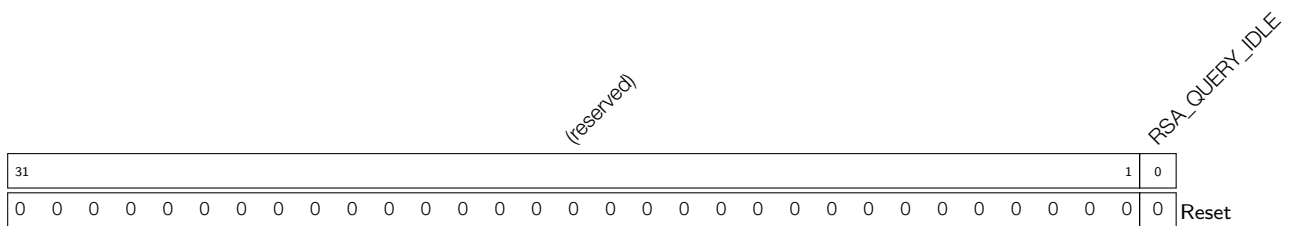

RSA_QUERY_IDLE Represents the RSA status.

- 0: Busy
 - 1: Idle
- (RO)

Register 21.7. RSA_CONSTANT_TIME_REG (0x0820)

(reserved)																RSA_CONSTANT_TIME	
31																1	0
0 0																1	Reset

RSA_CONSTANT_TIME Configures the constant_time option.

0: Acceleration

1: No acceleration (default)

(R/W)

Register 21.8. RSA_SEARCH_ENABLE_REG (0x0824)

(reserved)																RSA_SEARCH_ENABLE	
31																1	0
0 0																0	Reset

RSA_SEARCH_ENABLE Configures the search option.

0: No acceleration (default)

1: Acceleration

This option should be used together with [RSA_SEARCH_POS_REG](#). (R/W)

Register 21.9. RSA_SEARCH_POS_REG (0x0828)

(reserved)																RSA_SEARCH_POS		
31											12	11	0					
0 0																0		Reset

RSA_SEARCH_POS Configures the starting address to start search. This field should be used together with [RSA_SEARCH_ENABLE_REG](#). The field is only valid when [RSA_SEARCH_ENABLE](#) is high. (R/W)

Register 21.10. RSA_QUERY_CLEAN_REG (0x0808)

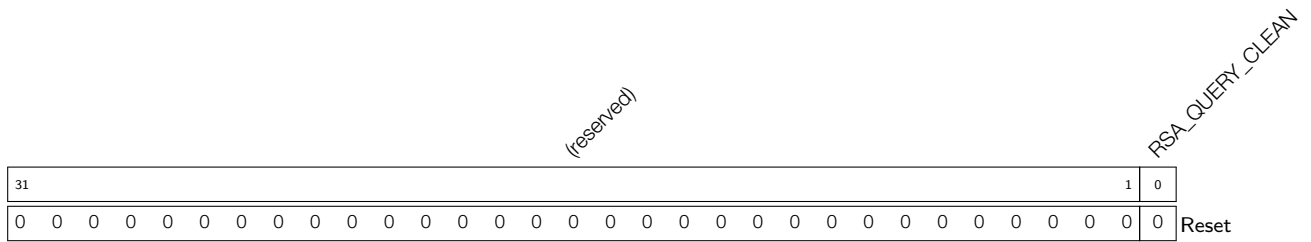

RSA_QUERY_CLEAN Represents whether or not the RSA memory completes initialization.

0: Not complete

1: Completed

(RO)

Register 21.11. RSA_INT_CLR_REG (0x081C)

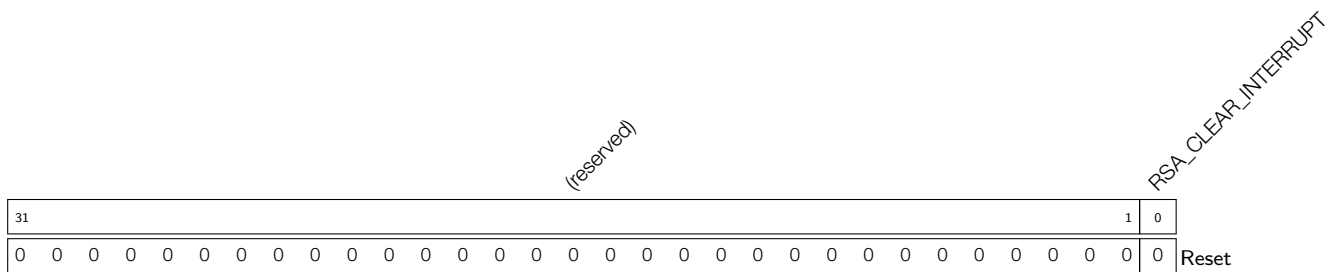

RSA_CLEAR_INTERRUPT Write 1 to clear the RSA interrupt. (WT)

Register 21.12. RSA_INT_ENA_REG (0x082C)

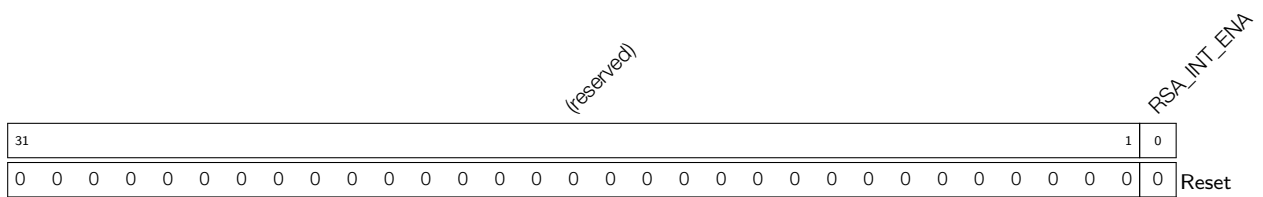

RSA_INT_ENA Write 1 to enable the RSA interrupt. (R/W)

Register 21.13. RSA_DATE_REG (0x0830)

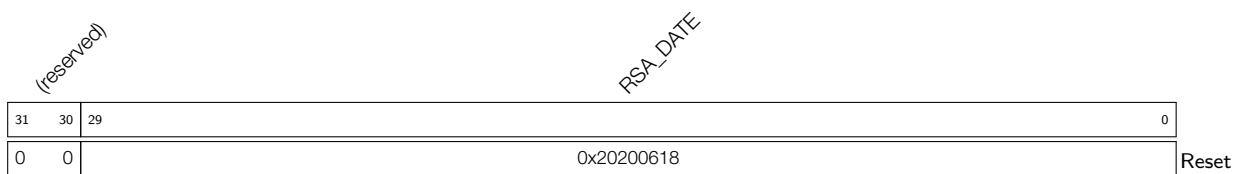

RSA_DATE Version control register. (R/W)

22 SHA Accelerator (SHA)

22.1 Introduction

ESP32-C6 integrates an SHA accelerator, which is a hardware device that speeds up the SHA algorithm significantly, compared to a SHA algorithm implemented solely in software. The SHA accelerator integrated in ESP32-C6 has two working modes, which are [Typical SHA](#) and [DMA-SHA](#).

22.2 Features

The following functionality is supported:

- The following hash algorithms introduced in [FIPS PUB 180-4 Spec.](#)
 - SHA-1
 - SHA-224
 - SHA-256
- Two working modes
 - Typical SHA
 - DMA-SHA
- Interleaved function when working in Typical SHA working mode
- Interrupt function when working in DMA-SHA working mode

22.3 Working Modes

The SHA accelerator integrated in ESP32-C6 has two working modes.

- [Typical SHA Working Mode](#): all the data is written and read via CPU directly.
- [DMA-SHA Working Mode](#): all the data is read via DMA. That is, users can configure the DMA controller to read all the data needed for hash operation, thus releasing CPU for completing other tasks.

The SHA accelerator is activated by setting the [PCR_SHA_CLK_EN](#) bit and clearing the [PCR_SHA_RST_EN](#) bit in the [PCR_SHA_CONF_REG](#) register. Additionally, users also need to clear [PCR_DS_RST_EN](#) and [PCR_HMAC_RST_EN](#) bits to reset [Digital Signature \(DS\)](#) and [HMAC Accelerator \(HMAC\)](#).

Users can start the SHA accelerator with different working modes by configuring registers [SHA_START_REG](#) and [SHA_DMA_START_REG](#). For details, please see [Table 22-1](#).

Table 22-1. SHA Accelerator Working Mode

Working Mode	Configuration Method
Typical SHA	Set SHA_START_REG to 1
DMA-SHA	Set SHA_DMA_START_REG to 1

Users can choose hash algorithms by configuring the [SHA_MODE_REG](#) register. For details, please see Table 22-2.

Table 22-2. SHA Hash Algorithm Selection

Hash Algorithm	SHA_MODE_REG Configuration
SHA-1	0
SHA-224	1
SHA-256	2

Notice:

ESP32-C6's [Digital Signature \(DS\)](#) and [HMAC Accelerator \(HMAC\)](#) modules also call the SHA accelerator. Therefore, users cannot access the SHA accelerator when these modules are working.

22.4 Function Description

The SHA accelerator generates the message digest via two steps: [Preprocessing](#) and [Hash operation](#).

22.4.1 Preprocessing

Preprocessing consists of three steps: [padding the message](#), [parsing the message into message blocks](#) and [setting the initial hash value](#).

22.4.1.1 Padding the Message

The SHA accelerator can only process message blocks of 512 bits. Thus, all the messages should be padded to a multiple of 512 bits before the hash operation.

Suppose that the length of the message M is m bits. Then M shall be padded as introduced below:

1. First, append the bit "1" to the end of the message;
2. Second, append k bits of zeros, where k is the smallest, non-negative solution to the equation $m + 1 + k \equiv 448 \pmod{512}$;
3. Last, append the 64-bit block of value equal to the number m expressed using a binary representation.

For more details, please refer to [FIPS PUB 180-4 Spec](#) > Section "Padding the Message".

22.4.1.2 Parsing the Message

The message and its padding must be parsed into N 512-bit blocks, $M^{(1)}, M^{(2)}, \dots, M^{(N)}$. Since the 512 bits of the input block may be expressed as sixteen 32-bit words, the first 32 bits of message block i are denoted $M_0^{(i)}$, the next 32 bits are $M_1^{(i)}$, and so on up to $M_{15}^{(i)}$.

During the task, all the message blocks are written into the [SHA_M_n_REG](#): $M_0^{(i)}$ is stored in [SHA_M_0_REG](#), $M_1^{(i)}$ stored in [SHA_M_1_REG](#), ..., and $M_{15}^{(i)}$ stored in [SHA_M_15_REG](#).

Note:

For more information about “message block”, please refer to [FIPS PUB 180-4 Spec](#) > Section “Glossary of Terms and Acronyms”.

22.4.1.3 Setting the Initial Hash Value

Before hash operation begins for any secure hash algorithms, the initial Hash value $H(0)$ must be set based on different algorithms. However, the SHA accelerator uses the initial Hash values (constant C) stored in the hardware for hash tasks.

22.4.2 Hash Operation

After the preprocessing, the ESP32-C6 SHA accelerator starts to hash a message M and generates message digest of different lengths, depending on different hash algorithms. As described above, the ESP32-C6 SHA accelerator supports two working modes, which are [Typical SHA](#) and [DMA-SHA](#). The operation process for the SHA accelerator under two working modes is described in the following subsections.

22.4.2.1 Typical SHA Mode Process

Usually, the SHA accelerator will process all blocks of a message and produce a message digest before starting the computation of the next message digest.

However, ESP32-C6 SHA also supports optional “interleaved” message digest calculation in Typical SHA mode, which means before SHA completes all blocks of the current message, users are given a chance to insert new computation of another message digest upon the completion of each individual block of the current message.

Specifically, users can read out the message digest from registers [SHA_H_n_REG](#) after completing part of a message digest calculation, and use the SHA accelerator for a different calculation. After the different calculation completes, users can restore the previous message digest to registers [SHA_H_n_REG](#), and resume the accelerator with the previously paused calculation.

Typical SHA Process

1. Select a hash algorithm.
 - Configure the [SHA_MODE_REG](#) register based on Table [22-2](#).
2. Process the current message block.
 - Write the message block in registers [SHA_M_n_REG](#).
3. Start the SHA accelerator¹.
 - If this is the first time to execute this step, set the [SHA_START_REG](#) register to 1 to start the SHA accelerator. In this case, the accelerator uses the initial hash value stored in hardware for a given algorithm configured in Step 1 to start the calculation;
 - If this is not the first time to execute this step², set the [SHA_CONTINUE_REG](#) register to 1 to start the SHA accelerator. In this case, the accelerator uses the hash value stored in the [SHA_H_n_REG](#) register to start calculation.

4. Check the progress of the current message block.
 - Poll register [SHA_BUSY_REG](#) until the content of this register becomes 0, indicating the accelerator has completed the calculation for the current message block and now is in the “idle” status ³.
5. Decide if you have more message blocks to process:
 - If yes, please go back to Step 2.
 - Otherwise, please continue.
6. Obtain the message digest.
 - Read the message digest from registers [SHA_H_n_REG](#).

Note:

1. In this step, the software can also write the next message block (to be processed) in registers [SHA_M_n_REG](#), if any, while the hardware starts SHA calculation, to save time.
2. You are resuming the SHA accelerator with the previously paused calculation.
3. Here you can decide if you want to insert other calculations. If yes, please go to the [process for interleaved calculations](#) for details.

As mentioned above, ESP32-C6 SHA accelerator supports “interleaving” calculation under the **Typical SHA working mode**.

The process to implement interleaved calculation is described below.

1. Prepare to hand the SHA accelerator over for an interleaved calculation by storing the following data of the previous calculation.
 - The selected hash algorithm configured in the [SHA_MODE_REG](#) register.
 - The message digest stored in registers [SHA_H_n_REG](#).
2. Perform the interleaved calculation. For the detailed process of the interleaved calculation, please refer to [Typical SHA process](#) or [DMA-SHA process](#), depending on the working mode of your interleaved calculation.
3. Prepare to hand the SHA accelerator back to the previously paused calculation by restoring the following data of the previous calculation.
 - Write the previously stored hash algorithm back to register [SHA_MODE_REG](#).
 - Write the previously stored message digest back to registers [SHA_H_n_REG](#).
4. Write the next message block from the previous paused calculation in registers [SHA_M_n_REG](#), and set the [SHA_CONTINUE_REG](#) register to 1 to restart the SHA accelerator with the previously paused calculation.

22.4.2.2 DMA-SHA Mode Process

ESP32-C6 SHA accelerator does not support “interleaving” message digest calculation at the level of individual message blocks when using DMA, which means you cannot insert new calculation before a complete DMA-SHA process (of one or more message blocks) completes. In this case, users who need interleaved operation are recommended to divide the message blocks and perform several DMA-SHA calculations, instead of trying to compute all the messages in one go.

Single DMA-SHA calculation supports up to 63 data blocks.

In contrast to the Typical SHA working mode, when the SHA accelerator is working under the DMA-SHA mode, all data read are completed via DMA. Therefore, users are required to configure the DMA controller following the description in Chapter 4 *GDMA Controller (GDMA)*.

DMA-SHA process

1. Select a hash algorithm.
 - Select a hash algorithm by configuring the [SHA_MODE_REG](#) register. For details, please refer to Table 22-2.
2. Configure the [SHA_IRQ_ENA_REG](#) register to enable or disable interrupt (Set 1 to enable).
3. Configure the number of message blocks.
 - Write the number of message blocks M to the [SHA_DMA_BLOCK_NUM_REG](#) register.
4. Start the DMA-SHA calculation.
 - If the current DMA-SHA calculation follows a previous calculation, firstly write the message digest from the previous calculation to registers [SHA_H_n_REG](#), then write 1 to register [SHA_DMA_CONTINUE_REG](#) to start SHA accelerator;
 - Otherwise, write 1 to register [SHA_DMA_START_REG](#) to start the accelerator.
5. Wait till the completion of the DMA-SHA calculation, which happens when:
 - The content of [SHA_BUSY_REG](#) register becomes 0, or
 - An SHA interrupt occurs. In this case, please clear interrupt by writing 1 to the [SHA_CLEAR_IRQ_REG](#) register.
6. Obtain the message digest:
 - Read the message digest from registers [SHA_H_n_REG](#).

22.4.3 Message Digest

After the hash task completes, the SHA accelerator writes the message digest from the task to registers [SHA_H_n_REG](#) (n : 0~7). The lengths of the generated message digest are different depending on different hash algorithms. For details, see Table 22-3 below:

Table 22-3. The Storage and Length of Message Digest from Different Algorithms

Hash Algorithm	Length of Message Digest (in bits)	Storage ¹
SHA-1	160	SHA_H_0_REG ~ SHA_H_4_REG
SHA-224	224	SHA_H_0_REG ~ SHA_H_6_REG
SHA-256	256	SHA_H_0_REG ~ SHA_H_7_REG

¹ The message digest is stored in registers from most significant bits to the least significant bits, with the first word stored in register [SHA_H_0_REG](#) and the second word stored in register [SHA_H_1_REG](#)... For details, please see subsection 22.4.1.2.

22.4.4 Interrupt

When working in the DMA-SHA mode, SHA supports interrupt on the completion of message digest calculation.

- To enable this function: write 1 to register [SHA_IRQ_ENA_REG](#).
- Note that the interrupt should be cleared by software after use via setting the [SHA_CLEAR_IRQ_REG](#) register to 1.

When working in the Typical SHA mode, SHA completes the calculation quick fast, so interrupt is not necessary. Therefore, SHA does not support interrupt in the Typical SHA mode.

22.5 Register Summary

The addresses in this section are relative to the SHA accelerator base address provided in Table 5-2 in Chapter 5 *System and Memory*.

The abbreviations given in Column **Access** are explained in Section *Access Types for Registers*.

Name	Description	Address	Access
Control/Configuration Registers			
SHA_MODE_REG	Configures SHA algorithm	0x0000	R/W
SHA_CONTINUE_REG	Continues SHA operation (only effective in Typical SHA mode)	0x0014	WO
SHA_DMA_START_REG	Starts the SHA accelerator for DMA-SHA operation	0x001C	WO
SHA_START_REG	Starts the SHA accelerator for Typical SHA operation	0x0010	WO
SHA_DMA_CONTINUE_REG	Continues SHA operation (only effective in DMA-SHA mode)	0x0020	WO
SHA_DMA_BLOCK_NUM_REG	Block number register (only effective for DMA-SHA)	0x000C	R/W
Status Registers			
SHA_BUSY_REG	Represents if SHA Accelerator is busy or not	0x0018	RO
Interrupt Registers			
SHA_CLEAR_IRQ_REG	DMA-SHA interrupt clear register	0x0024	WO
SHA_IRQ_ENA_REG	DMA-SHA interrupt enable register	0x0028	R/W
Data Registers			
SHA_H_0_REG	Hash value	0x0040	R/W
SHA_H_1_REG	Hash value	0x0044	R/W
SHA_H_2_REG	Hash value	0x0048	R/W
SHA_H_3_REG	Hash value	0x004C	R/W
SHA_H_4_REG	Hash value	0x0050	R/W
SHA_H_5_REG	Hash value	0x0054	R/W
SHA_H_6_REG	Hash value	0x0058	R/W
SHA_H_7_REG	Hash value	0x005C	R/W
SHA_M_0_REG	Message	0x0080	R/W
SHA_M_1_REG	Message	0x0084	R/W
SHA_M_2_REG	Message	0x0088	R/W
SHA_M_3_REG	Message	0x008C	R/W
SHA_M_4_REG	Message	0x0090	R/W
SHA_M_5_REG	Message	0x0094	R/W
SHA_M_6_REG	Message	0x0098	R/W
SHA_M_7_REG	Message	0x009C	R/W
SHA_M_8_REG	Message	0x00A0	R/W
SHA_M_9_REG	Message	0x00A4	R/W
SHA_M_10_REG	Message	0x00A8	R/W
SHA_M_11_REG	Message	0x00AC	R/W
SHA_M_12_REG	Message	0x00B0	R/W
SHA_M_13_REG	Message	0x00B4	R/W
SHA_M_14_REG	Message	0x00B8	R/W
SHA_M_15_REG	Message	0x00BC	R/W
Version Register			

Name	Description	Address	Access
SHA_DATE_REG	Version control register	0x002C	R/W

22.6 Registers

The addresses in this section are relative to the SHA accelerator base address provided in Table 5-2 in Chapter 5 *System and Memory*.

Register 22.1. SHA_START_REG (0x0010)

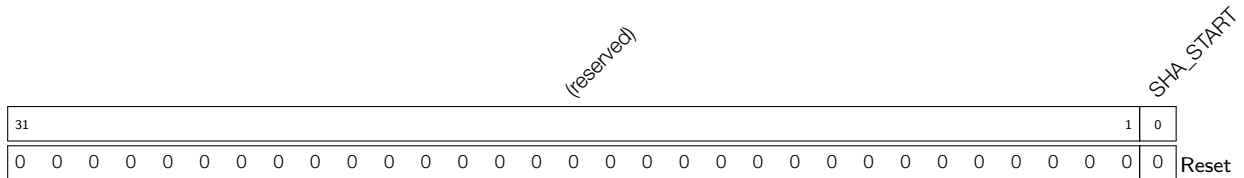

SHA_START Write 1 to start Typical SHA calculation. (WO)

Register 22.2. SHA_CONTINUE_REG (0x0014)

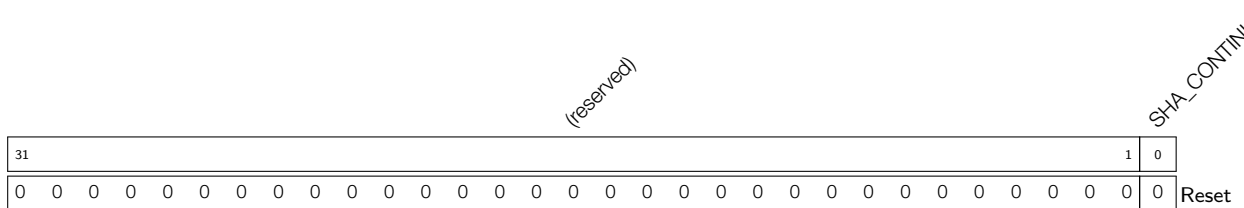

SHA_CONTINUE Write 1 to continue Typical SHA calculation. (WO)

Register 22.3. SHA_BUSY_REG (0x0018)

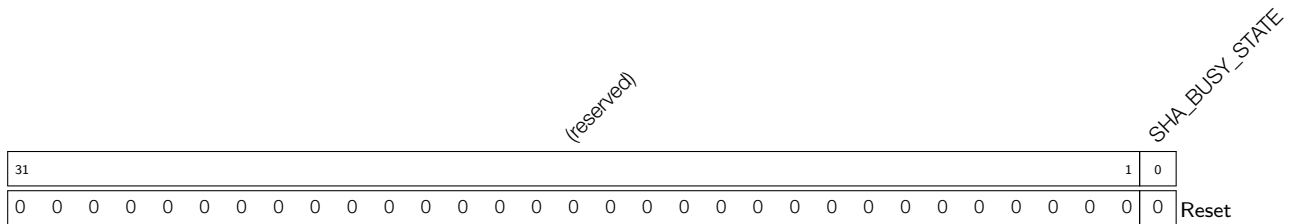

SHA_BUSY_STATE Represents the states of SHA accelerator.

- 0: idle
 - 1: busy
- (RO)

Register 22.4. SHA_DMA_START_REG (0x001C)

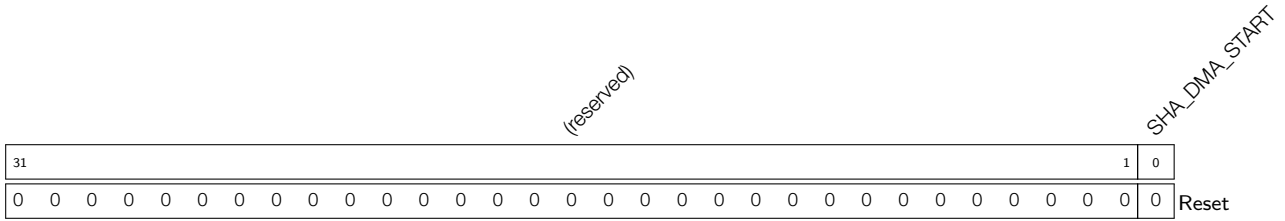

SHA_DMA_START Write 1 to start DMA-SHA calculation. (WO)

Register 22.5. SHA_DMA_CONTINUE_REG (0x0020)

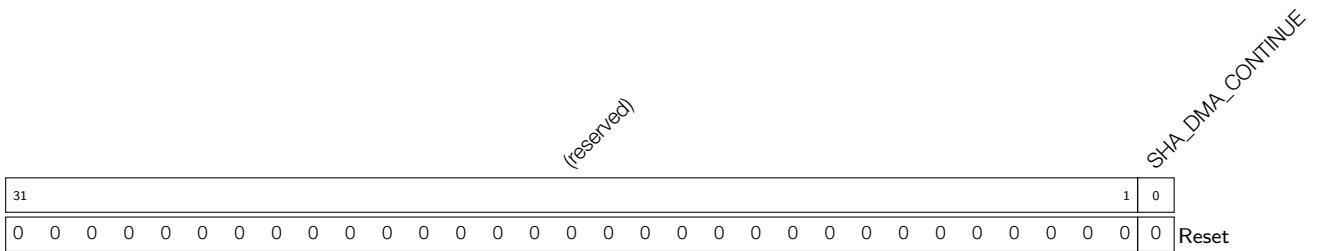

SHA_DMA_CONTINUE Write 1 to continue DMA-SHA calculation. (WO)

Register 22.6. SHA_CLEAR_IRQ_REG (0x0024)

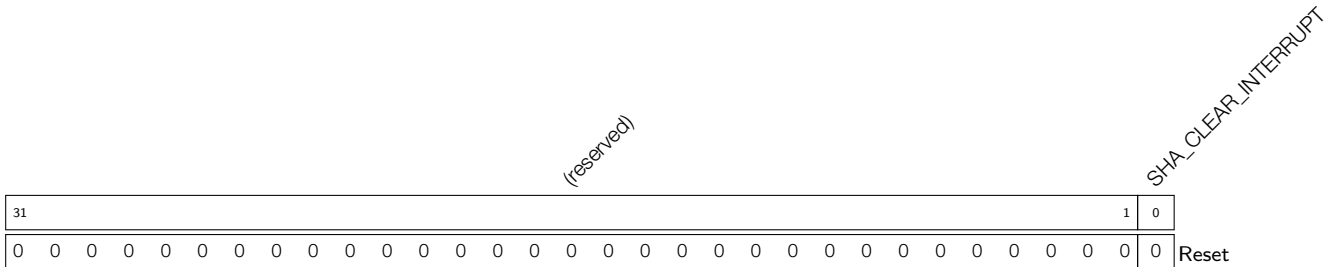

SHA_CLEAR_INTERRUPT Write 1 to clear DMA-SHA interrupt. (WO)

Register 22.7. SHA_IRQ_ENA_REG (0x0028)

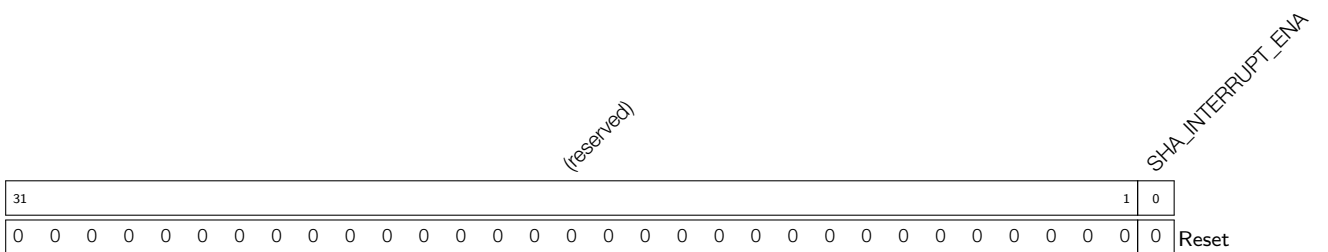

SHA_INTERRUPT_ENA Write 1 to enable DMA-SHA interrupt. (R/W)

Register 22.8. SHA_DATE_REG (0x002C)

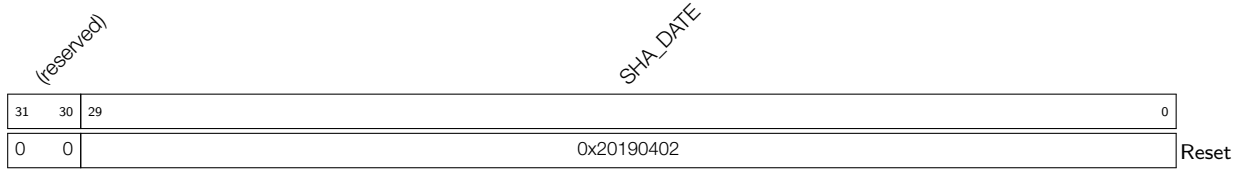

SHA_DATE Version control register. (R/W)

Register 22.9. SHA_MODE_REG (0x0000)

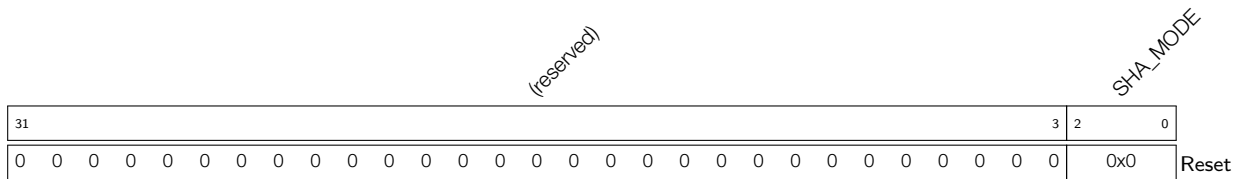

SHA_MODE Configures the SHA algorithm.

- 0: SHA-1
- 1: SHA-224
- 2: SHA-256

(R/W)

Register 22.10. SHA_DMA_BLOCK_NUM_REG (0x000C)

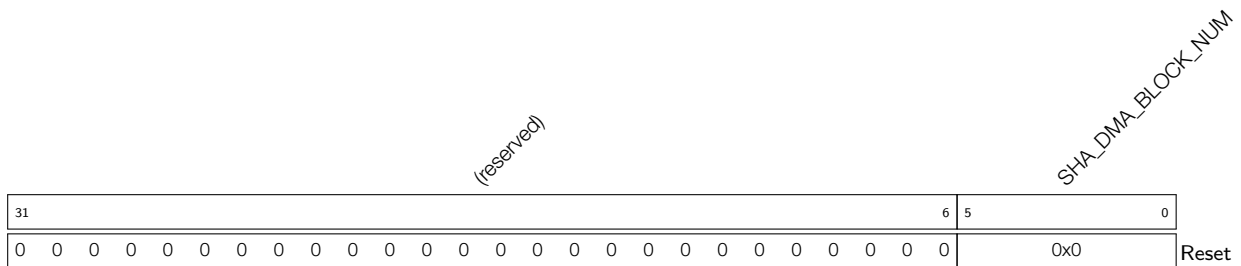

SHA_DMA_BLOCK_NUM Configures the DMA-SHA block number. (R/W)

Register 22.11. SHA_H_n_REG (n: 0-7) (0x0040+4*n)

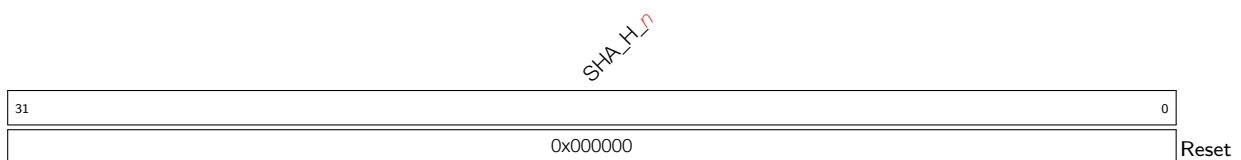

SHA_H_n Represents the *n*th 32-bit piece of the Hash value. (R/W)

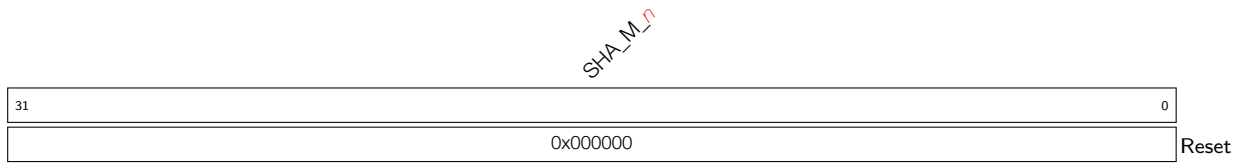
Register 22.12. SHA_M_n_REG (n : 0-15) ($0x0080+4*n$)

SHA_M_n Represents the n th 32-bit piece of the message. (R/W)

23 Digital Signature (DS)

23.1 Overview

A Digital Signature (DS) is used to verify the authenticity and integrity of a message using a cryptographic algorithm. This can be used to validate a device's identity to a server, or to check the integrity of a message.

ESP32-C6 includes a Digital Signature (DS) module providing hardware acceleration of messages' signatures based on RSA. HMAC is used as the key derivation function to output the DS_KEY key using eFuse as the input key. Subsequently, the DS module uses DS_KEY to decrypt the pre-encrypted parameters and calculate the signature. The whole process happens in hardware so that neither the decryption key for the RSA parameters nor the input key for the HMAC key derivation function can be seen by users while calculating the signature.

23.2 Features

- RSA digital signatures with key length up to 3072 bits
- Encrypted private key data, only decryptable by DS module
- SHA-256 digest to protect private key data against tampering by an attacker

23.3 Functional Description

23.3.1 Overview

The DS peripheral calculates RSA signatures as $Z = X^Y \bmod M$, where Z is the signature, X is the input message, and Y and M are the RSA private key parameters.

Private key parameters are stored in flash as ciphertext. They are decrypted using a key (DS_KEY) which can only be calculated by the DS peripheral via the HMAC peripheral. The required inputs ($HMAC_KEY$) to generate the key are only stored in eFuse and can only be accessed by the HMAC peripheral. That is to say, the DS peripheral hardware can decrypt the private key, and the private key in plaintext is never accessed by the software. For more detailed information about eFuse and HMAC peripherals, please refer to Chapter 6 [eFuse Controller](#) and 20 [HMAC Accelerator \(HMAC\)](#) peripheral.

The input message X will be sent directly to the DS peripheral by the software each time a signature is needed. After the RSA signature operation, the signature Z is read back by the software.

For better understanding, we define some symbols and functions here, which are only applicable to this chapter:

- 1^s A bit string consisting of s bits with the value of "1".
- $[x]_s$ A bit string of s bits, in which s is an integer multiple of 8 bits. If x is a number ($x < 2^s$), it is represented in little endian byte order in the bit string. x may be a variable such as $[Y]_{4096}$ or a hexadecimal constant such as $[0x0C]_8$. If necessary, the value $[x]_t$ can be right-padded with $(s - t)$ number of zeros to reach s bits in length, and finally get $[x]_s$. For example, $[0x05]_8 = 00000101$, $[0x05]_{16} = 0000010100000000$, $[0x0005]_{16} = 0000000000000101$, $[0x13]_8 = 00010011$, $[0x13]_{16} = 0001001100000000$, $[0x0013]_{16} = 0000000000010011$.
- $||$ A bit string concatenation operator for joining multiple bit strings into a longer bit string.

PRELIMINARY

23.3.2 Private Key Operands

Private key operands Y (private key exponent) and M (key modulus) are generated by the user. They have a particular RSA key length (up to 3072 bits). Two additional private key operands are needed: \bar{r} and M' . These two operands are derived from Y and M .

Operands Y , M , \bar{r} , and M' are encrypted by the user along with an authentication digest and stored as a single ciphertext C . C is input to the DS peripheral in this encrypted format, decrypted by the hardware, and then used for RSA signature calculation. Detailed description of how to generate C is provided in Section 23.3.3.

The DS peripheral supports RSA signature calculation $Z = X^Y \bmod M$, in which the length of operands should be $N = 32 \times x$ where $x \in \{1, 2, 3, \dots, 96\}$. The bit lengths of arguments Z , X , Y , M , and \bar{r} should be an arbitrary value in N , and all of them in a calculation must be of the same length, while the bit length of M' should always be 32. For more detailed information about RSA calculation, please refer to Section 21.3.1 *Large-number Modular Exponentiation* in Chapter 21 *RSA Accelerator (RSA)*.

23.3.3 Software Prerequisites

If users want to use the DS module, the software needs to do a series of preparations, as shown in Figure 23-1. The left side lists preparations required by the software before the hardware starts RSA signature calculation, while the right side lists the hardware workflow during the entire calculation procedure.

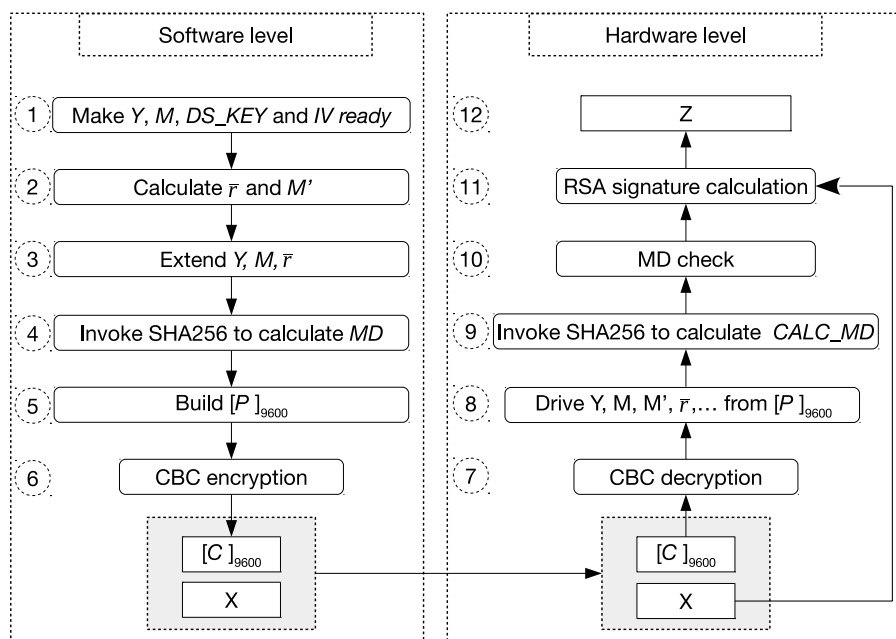

Figure 23-1. Software Preparations and Hardware Working Process

Note:

1. The software preparation (left side in the Figure 23-1) is a one-time operation before any signature is calculated, while the hardware calculation (right side in the Figure 23-1) repeats for every signature calculation.

Users need to follow the steps shown in the left part of Figure 23-1 to calculate C . Detailed instructions are as follows:

- **Step 1:** Prepare operands Y and M whose lengths should meet the requirements in Section 23.3.2.

Define $[L]_{32} = \frac{N}{32}$ (i.e., for RSA 3072, $[L]_{32} == [0x60]_{32}$). Prepare $[HMAC_KEY]_{256}$ and calculate $[DS_KEY]_{256}$ based on $DS_KEY = \text{HMAC-SHA256}([HMAC_KEY]_{256}, 1^{256})$. Generate a random $[IV]_{128}$ which should meet the requirements of the AES-CBC block encryption algorithm. For more information on AES, please refer to Chapter 18 *AES Accelerator (AES)*.

- **Step 2:** Calculate \bar{r} and M' based on M .
- **Step 3:** Extend Y , M , and \bar{r} , in order to get $[Y]_{3072}$, $[M]_{3072}$, and $[\bar{r}]_{3072}$, respectively. This step is only required for Y , M , and \bar{r} whose length are less than 3072 bits, since their largest length are 3072 bits.
- **Step 4:** Calculate MD authentication code using the SHA-256:
 $[MD]_{256} = \text{SHA256}([Y]_{3072} || [M]_{3072} || [\bar{r}]_{3072} || [M']_{32} || [L]_{32} || [IV]_{128})$
- **Step 5:** Build $[P]_{9600} = ([Y]_{3072} || [M]_{3072} || [\bar{r}]_{3072} || [Box]_{384})$, where $[Box]_{384} = ([MD]_{256} || [M']_{32} || [L]_{32} || [\beta]_{64})$ and $[\beta]_{64}$ is a PKCS#7 padding value, i.e., a $[0x0808080808080808]_{64}$ string composed of 8 bytes (0x80). The purpose of $[\beta]_{64}$ is to make the bit length of P a multiple of 128.
- **Step 6:** Calculate $C = [C]_{9600} = \text{AES-CBC-ENC}([P]_{9600}, [DS_KEY]_{256}, [IV]_{128})$, where C is the ciphertext with a length of 1200 bytes. C can also be calculated as $C = [C]_{9600} = ([\hat{Y}]_{3072} || [\hat{M}]_{3072} || [\hat{r}]_{3072} || [\hat{Box}]_{384})$, where $[\hat{Y}]_{3072}$, $[\hat{M}]_{3072}$, $[\hat{r}]_{3072}$, $[\hat{Box}]_{384}$ are the four sub-parameters of C , and correspond to the ciphertext of $[Y]_{3072}$, $[M]_{3072}$, $[\bar{r}]_{3072}$, $[Box]_{384}$ respectively.

23.3.4 DS Operation at the Hardware Level

The hardware operation is triggered each time a digital signature needs to be calculated. The inputs are the pre-generated private key ciphertext C , a unique message X , and IV .

The DS operation at the hardware level can be divided into the following three stages:

1. Decryption: Step 7 and 8 in Figure 23-1

The decryption process is the inverse of Step 6 in figure 23-1. The DS module will call the AES accelerator to decrypt C in CBC block mode and get the resulting plaintext. The decryption process can be represented by $P = \text{AES-CBC-DEC}(C, DS_KEY, IV)$, where IV (i.e., $[IV]_{128}$) is defined by the user. $[DS_KEY]_{256}$ is provided by the HMAC module, derived from $HMAC_KEY$ stored in eFuse. $[DS_KEY]_{256}$, as well as $[HMAC_KEY]_{256}$ are not readable by users.

With P , the DS module can derive $[Y]_{3072}$, $[M]_{3072}$, $[\bar{r}]_{3072}$, $[M']_{32}$, $[L]_{32}$, MD authentication code, and the padding value $[\beta]_{64}$. This process is the inverse of Step 5.

2. Check: Step 9 and 10 in Figure 23-1

The DS module will perform two checks: MD check and padding check. Padding check is not shown in Figure 23-1, as it happens at the same time as MD check.

- MD check: The DS module calls SHA-256 to calculate the hash value $[CALC_MD]_{256}$ ($[CALC_MD]_{256}$ is calculated the same way and with same parameters as $[MD]_{256}$, see step 4). Then, $[CALC_MD]_{256}$ is compared against the MD authentication code $[MD]_{256}$ from step 4. Only when the two match does the MD check pass.
- Padding check: The DS module checks if $[\beta]_{64}$ complies with the aforementioned PKCS#7 format. Only when $[\beta]_{64}$ complies with the format does the padding check pass.

The DS module will only perform subsequent operations if MD check passes. If padding check fails, a warning is generated, but it does not affect the subsequent operations.

3. Calculation: Step 11 and 12 in Figure 23-1

The DS module treats X (input by the user) and Y , M , \bar{r} (decrypted in step 8) as big numbers. With M' , all operands to perform $X^Y \bmod M$ are in place. The operand length is defined by L only. The DS module will calculate the signed result Z by calling RSA to perform $Z = X^Y \bmod M$.

23.3.5 DS Operation at the Software Level

The software steps below should be followed each time a digital signature needs to be calculated. The inputs are the pre-generated private key ciphertext C , a unique message X , and IV . These software steps trigger the hardware steps described in Section 23.3.4.

We assume that the software has called the HMAC peripheral and the HMAC peripheral has calculated DS_KEY based on $HMAC_KEY$.

1. **Prerequisites:** Prepare operands C , X , IV according to Section 23.3.3.
2. **Activate the DS peripheral:** Write 1 to `DS_SET_START_REG`.
3. **Check if DS_KEY is ready:** Poll `DS_QUERY_BUSY_REG` until the software reads 0.

If the software does not read 0 in `DS_QUERY_BUSY_REG` after approximately 1 ms, it indicates a problem with HMAC initialization. In such a case, the software can read register `DS_QUERY_KEY_WRONG_REG` to get more information:

- If the software reads 0 in `DS_QUERY_KEY_WRONG_REG`, it indicates that the HMAC peripheral has not been called.
 - If the software reads any value from 1 to 15 in `DS_QUERY_KEY_WRONG_REG`, it indicates that HMAC was called, but the DS module did not successfully get the DS_KEY value from the HMAC peripheral. This may indicate that the HMAC operation has been interrupted due to a software concurrency problem.
4. **Configure register:** Write IV block to register `DS_IV_m_REG` (m : 0 ~ 3). For more information on the IV block, please refer to Chapter 18 *AES Accelerator (AES)*.
 5. **Write X to memory block DS_X_MEM :** Write X_i ($i \in \{0, 1, \dots, n - 1\}$), where $n = \frac{N}{32}$, to memory block `DS_X_MEM` whose capacity is 96 words. Each word can store one base- b digit. The memory block uses the little endian format for storage, i.e., the least significant digit of the operand is in the lowest address. Words in `DS_X_MEM` block after the configured length of X (N bits, as described in Section 23.3.2), are ignored.
 6. **Write C to corresponding memory blocks:** Write the four sub-parameters of C to corresponding memory blocks:
 - Write \widehat{Y}_i ($i \in \{0, 1, \dots, 95\}$) to `DS_Y_MEM`.
 - Write \widehat{M}_i ($i \in \{0, 1, \dots, 95\}$) to `DS_M_MEM`.
 - Write \widehat{r}_i ($i \in \{0, 1, \dots, 95\}$) to `DS_RB_MEM`.
 - write \widehat{Box}_i ($i \in \{0, 1, \dots, 11\}$) to `DS_BOX_MEM`.

The capacity of `DS_Y_MEM`, `DS_M_MEM`, and `DS_RB_MEM` is 96 words, whereas the capacity of `DS_BOX_MEM` is only 12 words. Each word can store one base- b digit. The memory blocks use the little endian format for storage, i.e., the least significant digit of the operand is in the lowest address.

7. **Start DS operation:** Write 1 to register [DS_SET_ME_REG](#).
8. **Wait for the operation to be completed:** Poll register [DS_QUERY_BUSY_REG](#) until the software reads 0.
9. **Query check result:** Read register [DS_QUERY_CHECK_REG](#) and conduct subsequent operations as illustrated below based on the return value:
 - If the value is 0, it indicates that both padding check and MD check pass. Users can continue to get the signed result Z .
 - If the value is 1, it indicates that the padding check passes but MD check fails. The signed result Z is invalid. The operation will resume directly from Step 11.
 - If the value is 2, it indicates that the padding check fails but MD check passes. Users can continue to get the signed result Z . But please note that the data does not comply with the aforementioned PKCS#7 padding format, which may not be what you want.
 - If the value is 3, it indicates that both padding check and MD check fail. In this case, some fatal errors have occurred and the signed result Z is invalid. The operation will resume directly from Step 11.
10. **Read the signed result:** Read the signed result Z_i ($i \in \{0, 1, \dots, n - 1\}$), where $n = \frac{N}{32}$, from memory block [DS_Z_MEM](#). The memory block stores Z in little-endian byte order.
11. **Exit the operation:** Write 1 to [DS_SET_FINISH_REG](#), and then poll [DS_QUERY_BUSY_REG](#) until the software reads 0.

After the operation, all the input/output registers and memory blocks are cleared.

23.4 Memory Summary

The addresses in this section are relative to the Digital Signature base address provided in Table 5-2 in Chapter 5 *System and Memory*.

Name	Description	Size (byte)	Starting Address	Ending Address	Access
DS_Y_MEM	Memory block Y	384	0x0000	0x017F	WO
DS_M_MEM	Memory block M	384	0x0200	0x037F	WO
DS_RB_MEM	Memory block \bar{r}	384	0x0400	0x057F	WO
DS_BOX_MEM	Memory block Box	48	0x0600	0x062F	WO
DS_X_MEM	Memory block X	384	0x0800	0x097F	WO
DS_Z_MEM	Memory block Z	384	0x0A00	0x0B7F	RO

23.5 Register Summary

The addresses in this section are relative to Digital Signature base address provided in Table 5-2 in Chapter 5 *System and Memory*.

The abbreviations given in Column **Access** are explained in Section *Access Types for Registers*.

Name	Description	Address	Access
Configuration Registers			
DS_IV_0_REG	IV block data	0x0630	WO
DS_IV_1_REG	IV block data	0x0634	WO
DS_IV_2_REG	IV block data	0x0638	WO
DS_IV_3_REG	IV block data	0x063C	WO
Status/Control Registers			
DS_SET_START_REG	Activates the DS module	0x0E00	WO
DS_SET_ME_REG	Starts DS operation	0x0E04	WO
DS_SET_FINISH_REG	Ends DS operation	0x0E08	WO
DS_QUERY_BUSY_REG	Status of the DS module	0x0E0C	RO
DS_QUERY_KEY_WRONG_REG	Checks the reason why <i>DS_KEY</i> is not ready	0x0E10	RO
DS_QUERY_CHECK_REG	Queries DS check result	0x0E14	RO
Version control register			
DS_DATE_REG	Version control register	0x0E20	W/R

23.6 Registers

The addresses in this section are relative to Digital Signature base address provided in Table 5-2 in Chapter 5 *System and Memory*.

Register 23.1. DS_IV_m_REG (m: 0-3) (0x0630+4*n)

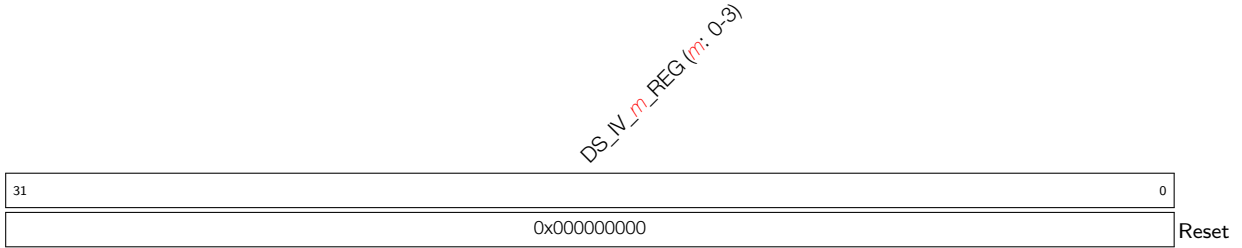

DS_IV_m_REG Writes IV block data. (WO)

Register 23.2. DS_SET_START_REG (0x0E00)

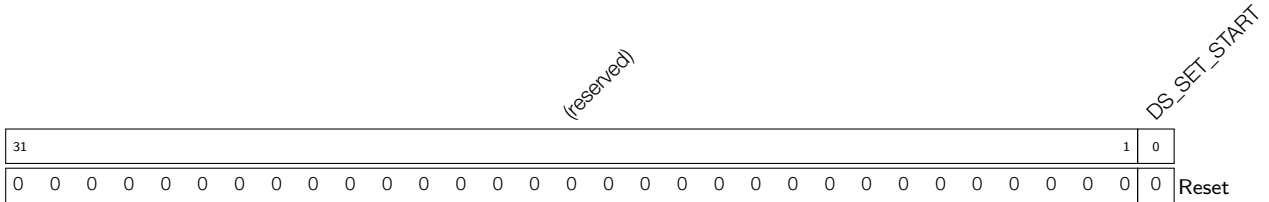

DS_SET_START Configures whether or not to activate the DS peripheral.
0: Invalid
1: Activate the DS peripheral
(WO)

Register 23.3. DS_SET_ME_REG (0x0E04)



DS_SET_ME Configures whether or not to start DS operation.
0: Invalid
1: Start DS operation
(WO)

Register 23.7. DS_QUERY_CHECK_REG (0x0E14)

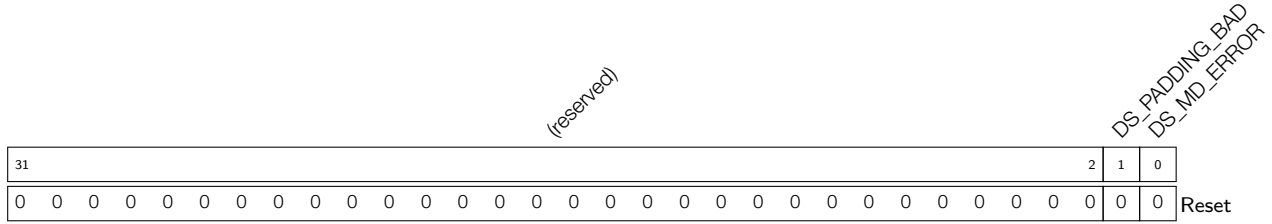

DS_PADDING_BAD Represents whether or not the padding check passes.
 0: The padding check passes
 1: The padding check fails
 (RO)

DS_MD_ERROR Represents whether or not the MD check passes.
 0: The MD check passes
 1: The MD check fails
 (RO)

Register 23.8. DS_DATE_REG (0x0E20)

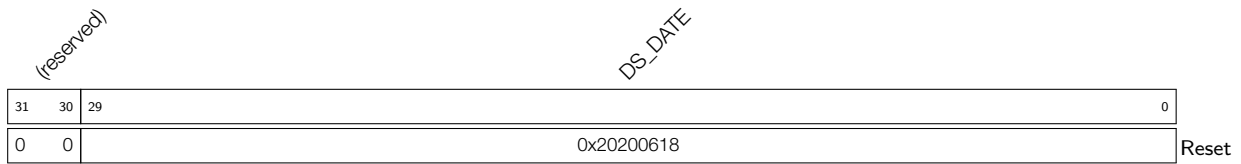

DS_DATE Version control register. (R/W)

24 External Memory Encryption and Decryption (XTS_AES)

24.1 Overview

The ESP32-C6 integrates an External Memory Encryption and Decryption module that complies with the XTS-AES standard algorithm specified in [IEEE Std 1619-2007](#), providing security for users' application code and data stored in the external memory (flash). Users can store proprietary firmware and sensitive data (e.g., credentials for gaining access to a private network) to the external flash.

24.2 Features

- General XTS-AES algorithm, compliant with IEEE Std 1619-2007
- Software-based manual encryption
- High-speed auto decryption without software's participation
- Encryption and decryption functions jointly enabled/disabled by registers configuration, eFuse parameters, and boot mode
- Configurable Anti-DPA

24.3 Module Structure

The External Memory Encryption and Decryption module consists of two blocks, namely the Manual Encryption block and Auto Decryption block. The module architecture is shown in Figure 24-1.

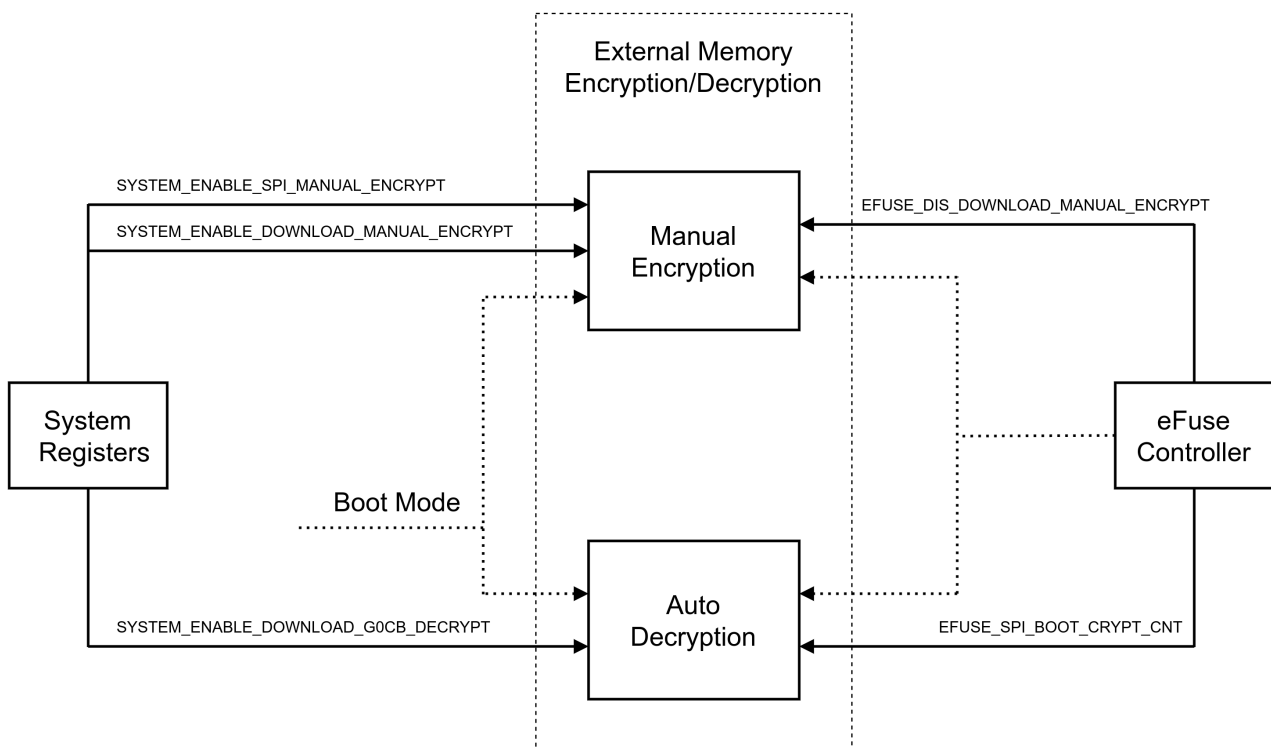

Figure 24-1. Architecture of the External Memory Encryption and Decryption

The Manual Encryption block can encrypt instructions/data which will then be written to the external flash as ciphertext via SPI1.

In the System Registers (HP_SYS) peripheral (see [16 System Registers \(HP_SYSTEM\)](#)), the following three bits in register `HP_SYSTEM_EXTERNAL_DEVICE_ENCRYPT_DECRYPT_CONTROL_REG` are relevant to the external memory encryption and decryption:

- `HP_SYSTEM_ENABLE_DOWNLOAD_MANUAL_ENCRYPT`
- `HP_SYSTEM_ENABLE_DOWNLOAD_GOCB_DECRYPT`
- `HP_SYSTEM_ENABLE_SPI_MANUAL_ENCRYPT`

The XTS_AES module also fetches two parameters from the peripheral eFuse Controller, which are: `EFUSE_DIS_DOWNLOAD_MANUAL_ENCRYPT` and `EFUSE_SPI_BOOT_CRYPT_CNT`. For detailed information, please see Chapter 6 [eFuse Controller](#).

24.4 Functional Description

24.4.1 XTS Algorithm

Both manual encryption and auto decryption use the XTS algorithm. During implementation, the XTS algorithm is characterized by a "data unit" of 1024 bits, defined in the Section *XTS-AES encryption procedure* of [XTS-AES Tweakable Block Cipher](#) Standard. For more information about XTS-AES algorithm, please refer to [IEEE Std 1619-2007](#).

24.4.2 Key

The Manual Encryption block and Auto Decryption block share the same *Key* when implementing XTS algorithm. The *Key* is provided by the eFuse hardware and cannot be accessed by users.

The *Key* is 256-bit long. The value of the *Key* is determined by the content in one eFuse block from BLOCK4 ~ BLOCK9. For easier description, we define:

- Block_A: the block whose key purpose is `EFUSE_KEY_PURPOSE_XTS_AES_128_KEY` (please refer to [Table 6-2 Structure](#)). If Block_A exists, a 256-bit *Key_A* is stored in it.

There are two possibilities of how the *Key* is generated depending on whether Block_A exists or not, as shown in [Table 24-1](#). In each case, the *Key* can be uniquely determined by *Key_A*.

Table 24-1. *Key* generated based on *Key_A*

Block _A	<i>Key</i>	<i>Key</i> Length (bit)
Yes	<i>Key_A</i>	256
No	0 ²⁵⁶	256

Notes:

"YES" indicates that the block exists; "NO" indicates that the block does not exist; "0²⁵⁶" indicates a bit string that consists of 256-bit zeros. Note that using 0²⁵⁶ as *Key* is not secure. We strongly recommend to configure a valid key.

For more information of key purposes, please refer to [Table 6-2 Structure](#) in Chapter 6 [eFuse Controller](#).

24.4.3 Target Memory Space

The target memory space refers to a continuous address space in the external memory (flash) where the ciphertext is stored. The target memory space can be uniquely determined by two relevant parameters: size and base address, whose definitions are listed below.

- Size: the *size* of the target memory space, indicating the number of bytes encrypted in one encryption operation, which supports 16 or 32 bytes.
- Base address: the *base_addr* of the target memory space. It is a 24-bit physical address, with range of 0x0000_0000 ~ 0x00FF_FFFF. It should be aligned to *size*, i.e., $base_addr \% size == 0$.

For example, if there are 16 bytes of instruction data need to be encrypted and written to address 0x130 ~ 0x13F in the external flash, then the target space is 0x130 ~ 0x13F, size is 16 (bytes), and base address is 0x130.

The encryption of any length (must be multiples of 16 bytes) of plaintext instruction/data can be completed separately in multiple operations, and each operation has its individual target memory space and the relevant parameters.

For Auto Decryption blocks, these parameters are automatically determined by hardware. For Manual Encryption blocks, these parameters should be configured by users.

Note:

The “tweak” defined in Section *Data units and tweaks* of [IEEE Std 1619-2007](#) is a 128-bit non-negative integer (*tweak*), which can be generated according to $tweak = (base_addr \& 0x00FFFF80)$. The lowest 7 bits and the highest 97 bits in *tweak* are always zero.

24.4.4 Data Writing

For Auto Decryption blocks, data writing is automatically applied in hardware. For Manual Encryption blocks, data writing should be applied by users. The Manual Encryption block has a register block which consists of 16 registers, i.e., XTS_AES_PLAIN_0_REG (*n*: 0 ~ 15), that are dedicated to data writing and can store up to 256 bits of plaintext at a time.

Actually, the Manual Encryption block does not care where the plaintext comes from, but only where the ciphertext will be stored. Because of the strict correspondence between plaintext and ciphertext, in order to better describe how the plaintext is stored in the register block, we assume that the plaintext is stored in the target memory space in the first place and replaced by ciphertext after encryption. Therefore, the following description in this section no longer has the concept of “plaintext”, but uses “target memory space” instead.

How mapping between target memory space and registers works:

Assume a word in the target memory space is stored in *address*, define $offset = address \% 64$, $n = offset / 4$, then the word will be stored in register XTS_AES_PLAIN_0_REG.

For example, when the *size* is 32, all registers in the register block will be used. The mapping between *offset* and registers now is shown in Table 24-2.

Table 24-2. Mapping Between Offsets and Registers

<i>offset</i>	Register	<i>offset</i>	Register
0x00	XTS_AES_PLAIN_0_REG	0x20	XTS_AES_PLAIN_8_REG

<i>offset</i>	Register	<i>offset</i>	Register
0x04	XTS_AES_PLAIN_1_REG	0x24	XTS_AES_PLAIN_9_REG
0x08	XTS_AES_PLAIN_2_REG	0x28	XTS_AES_PLAIN_10_REG
0x0C	XTS_AES_PLAIN_3_REG	0x2C	XTS_AES_PLAIN_11_REG
0x10	XTS_AES_PLAIN_4_REG	0x30	XTS_AES_PLAIN_12_REG
0x14	XTS_AES_PLAIN_5_REG	0x34	XTS_AES_PLAIN_13_REG
0x18	XTS_AES_PLAIN_6_REG	0x38	XTS_AES_PLAIN_14_REG
0x1C	XTS_AES_PLAIN_7_REG	0x3C	XTS_AES_PLAIN_15_REG

24.4.5 Manual Encryption Block

The Manual Encryption block is a peripheral module. It is equipped with registers and can be accessed by the CPU directly. Registers embedded in this block, the System Registers (HP_SYS) peripheral, eFuse parameters, and boot mode jointly configure and use this module.

The Manual Encryption block is operational only under certain conditions. The operating conditions are:

- In SPI Boot mode:

If bit [HP_SYSTEM_ENABLE_SPI_MANUAL_ENCRYPT](#) in register [HP_SYSTEM_EXTERNAL_DEVICE_ENCRYPT_DECRYPT_CONTROL_REG](#) is 1, the Manual Encryption block can be enabled. Otherwise, it is not operational.

- In Download Boot mode:

If bit [HP_SYSTEM_ENABLE_DOWNLOAD_MANUAL_ENCRYPT](#) in register [HP_SYSTEM_EXTERNAL_DEVICE_ENCRYPT_DECRYPT_CONTROL_REG](#) is 1 and the eFuse parameter [EFUSE_DIS_DOWNLOAD_MANUAL_ENCRYPT](#) is 0, the Manual Encryption block can be enabled. Otherwise, it is not operational.

Note:

Even though the CPU can skip cache and get the encrypted instruction/data directly by reading the external memory, users can by no means access *Key*.

24.4.6 Auto Decryption Block

The Auto Decryption block is not a conventional peripheral, so it does not have any registers and cannot be accessed by the CPU directly. The System Registers (HP_SYS) peripheral, eFuse parameters, and boot mode jointly configure and use this block.

The Auto Decryption block is operational only under certain conditions. The operating conditions are:

- In SPI Boot mode

If the first bit or the third bit in parameter [SPI_BOOT_CRYPT_CNT](#) (3 bits) is set to 1, then the Auto Decryption block can be enabled. Otherwise, it is not operational.

- In Download Boot mode

If bit [HP_SYSTEM_ENABLE_DOWNLOAD_G0CB_DECRYPT](#) in register

HP_SYSTEM_EXTERNAL_DEVICE_ENCRYPT_DECRYPT_CONTROL_REG is 1, the Auto Decryption block can be enabled. Otherwise, it is not operational.

Note:

- When the Auto Decryption block is enabled, it will automatically decrypt the ciphertext if the CPU reads instructions/data from the external memory via cache to retrieve the instructions/data. The entire decryption process does not need software participation and is transparent to the cache. Users can by no means obtain the decryption *Key* during the process.
- When the Auto Decryption block is disabled, it does not have any effect on the contents stored in the external memory, no matter if they are encrypted or not. Therefore, what the CPU reads via cache is the original information stored in the external memory.

24.5 Software Process

When the Manual Encryption block operates, software needs to be involved in the process. The steps are as follows:

1. Configure XTS_AES:

- Set register `XTS_AES_PHYSICAL_ADDRESS_REG` to *base_addr*.
- Set register `XTS_AES_LINESIZE_REG` to $\frac{size}{32}$.

For definitions of *base_addr* and *size*, please refer to Section [24.4.3](#).

2. Write plaintext instructions/data to the registers block `XTS_AES_PLAIN_n_REG` (*n*: 0-15). For detailed information, please refer to Section [24.4.4](#).

Please write data to registers according to your actual needs, and the unused ones could be set to arbitrary values.

3. Wait for Manual Encryption block to be idle. Poll register `XTS_AES_STATE_REG` until it reads 0 that indicates the Manual Encryption block is idle.

4. Trigger manual encryption by writing 1 to register `XTS_AES_TRIGGER_REG`.

5. Wait for the encryption process completion. Poll register `XTS_AES_STATE_REG` until it reads 2.

Step 1 to 5 are the steps of encrypting plaintext instructions/data with the Manual Encryption block using the Key.

6. Write 1 to register `XTS_AES_RELEASE_REG` to grant SPI1 the access to the encrypted ciphertext. After this, the value of register `XTS_AES_STATE_REG` will become 3.

7. Call SPI1 to write the ciphertext in the external flash (see Section [API Reference - Flash Encrypt](#) in [ESP-IDF Programming Guide](#)).

8. Write 1 to register `XTS_AES_DESTROY_REG` to destroy the ciphertext. After this, the value of register `XTS_AES_STATE_REG` will become 0.

Repeat above steps according to the amount of plaintext instructions/data that need to be encrypted.

24.6 Anti-DPA

ESP32-C6 XTS_AES supports Anti-DPA.

The XTS-AES algorithm can be divided into two steps, according to [IEEE Std 1619-2007](#):

- Step 1: Calculating T value. In this section, we define this step as "calculating T".
- Step 2: Calculating Cipher/Plain text. In this section, we define this step as "calculating D".

Different security levels can be configured through registers:

- First we define the below parameters for a better description:
 - *select_reg* = [XTS_AES_CRYPT_DPA_SELECT_REGISTER](#)
 - *reg_d_dpa_en* = [XTS_AES_CRYPT_CALC_D_DPA_EN](#)
 - *efuse_dpa_en* = [EFUSE_CRYPT_DPA_ENABLE](#)
 - *reg_anti_dpa_level* = [XTS_AES_CRYPT_SECURITY_LEVEL](#)
 - *efuse_anti_dpa_level* = 3

- Configure the security level of Anti-DPA for the XTS_AES module:

$$Anti_DPA_level = select_reg ? (reg_anti_dpa_level) : (efuse_dpa_en * efuse_anti_dpa_level)$$

When *Anti_DPA_level* equals to 0, Anti-DPA is disabled. The higher the value of *Anti_DPA_level* is, the stronger the Anti-DPA ability is.

- Configure whether or not to enable Anti-DPA when the XTS-AES algorithm is calculating D:

$$Anti_DPA_enabled_in_calc_D = select_reg ? reg_d_dpa_en : efuse_dpa_en$$

If *Anti_DPA_level* is not 0, when *Anti_DPA_enabled_in_calc_D* equals to 1, Anti-DPA is enabled when XTS-AES algorithm is calculating D.

If *Anti_DPA_level* is not 0, Anti-DPA is always enabled when the XTS-AES algorithm is calculating T.

Note:

Configuring whether or not to enable Anti-DPA will have an impact on the external storage access bandwidth:

- When Anti-DPA is enabled during the calculation of D, the read and write bandwidth will be significantly impacted when the Anti-Attack level ≥ 4 .
- When Anti-DPA is disabled during the calculation of D, the read and write bandwidth will be significantly impacted when the Anti-Attack level ≥ 6 .

24.7 Register Summary

The addresses in this section are relative to External Memory Encryption and Decryption base address provided in Table 5-2 in Chapter 5 *System and Memory*.

The abbreviations given in Column **Access** are explained in Section *Access Types for Registers*.

Name	Description	Address	Access
Plaintext Register Heap			
XTS_AES_PLAIN_0_REG	Plaintext register 0	0x0300	R/W
XTS_AES_PLAIN_1_REG	Plaintext register 1	0x0304	R/W
XTS_AES_PLAIN_2_REG	Plaintext register 2	0x0308	R/W
XTS_AES_PLAIN_3_REG	Plaintext register 3	0x030C	R/W
XTS_AES_PLAIN_4_REG	Plaintext register 4	0x0310	R/W
XTS_AES_PLAIN_5_REG	Plaintext register 5	0x0314	R/W
XTS_AES_PLAIN_6_REG	Plaintext register 6	0x0318	R/W
XTS_AES_PLAIN_7_REG	Plaintext register 7	0x031C	R/W
XTS_AES_PLAIN_8_REG	Plaintext register 8	0x0320	R/W
XTS_AES_PLAIN_9_REG	Plaintext register 9	0x0324	R/W
XTS_AES_PLAIN_10_REG	Plaintext register 10	0x0328	R/W
XTS_AES_PLAIN_11_REG	Plaintext register 11	0x032C	R/W
XTS_AES_PLAIN_12_REG	Plaintext register 12	0x0330	R/W
XTS_AES_PLAIN_13_REG	Plaintext register 13	0x0334	R/W
XTS_AES_PLAIN_14_REG	Plaintext register 14	0x0338	R/W
XTS_AES_PLAIN_15_REG	Plaintext register 15	0x033C	R/W
Configuration Registers			
XTS_AES_LINESIZE_REG	Configures the size of target memory space	0x0340	R/W
XTS_AES_DESTINATION_REG	Configures the type of the external memory	0x0344	R/W
XTS_AES_PHYSICAL_ADDRESS_REG	Physical address	0x0348	R/W
XTS_AES_DPA_CTRL_REG	Configures the Anti-DPA function	0x0388	R/W
Control/Status Registers			
XTS_AES_TRIGGER_REG	Activates AES algorithm	0x034C	WO
XTS_AES_RELEASE_REG	Release control	0x0350	WO
XTS_AES_DESTROY_REG	Destroy control	0x0354	WO
XTS_AES_STATE_REG	Status register	0x0358	RO
Version Register			
XTS_AES_DATE_REG	Version control register	0x035C	R/W

24.8 Registers

The addresses in this section are relative to External Memory Encryption and Decryption base address provided in Table 5-2 in Chapter 5 *System and Memory*.

Register 24.1. XTS_AES_PLAIN_n_REG (n: 0-15) (0x0300+4*n)

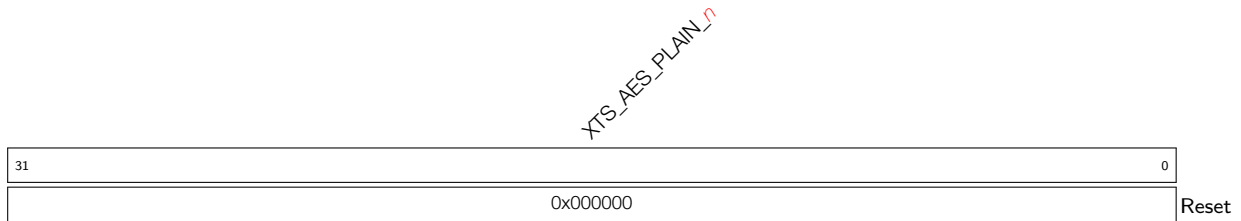

XTS_AES_PLAIN_n Configures the *n*th 32-bit piece of plain text. (R/W)

Register 24.2. XTS_AES_LINESIZE_REG (0x0340)

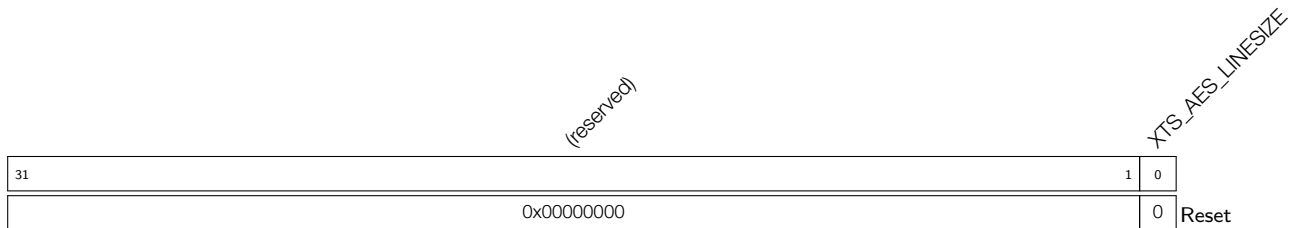

XTS_AES_LINESIZE Configures the data size of one encryption operation.

0: 16 bytes

1: 32 bytes

(R/W)

Register 24.3. XTS_AES_DESTINATION_REG (0x0344)

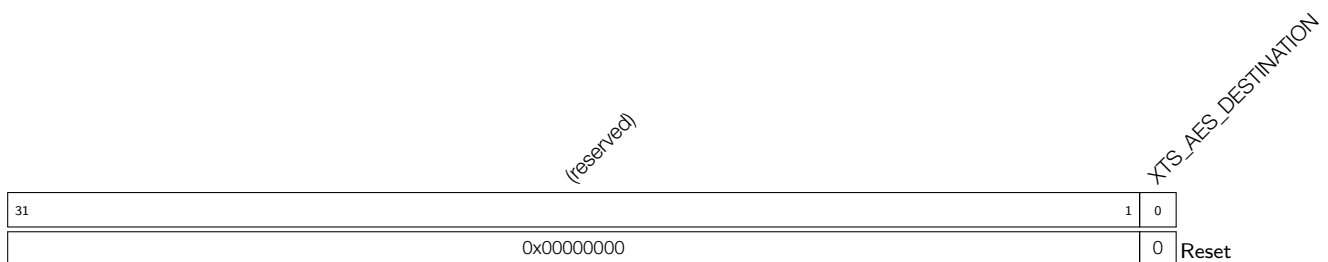

XTS_AES_DESTINATION Configures the type of external memory. Currently, it must be set to 0, as the Manual Encryption block only supports flash encryption. Errors may occur if users write 1.

0: flash

1: external RAM (may cause error)

(R/W)

Register 24.4. XTS_AES_PHYSICAL_ADDRESS_REG (0x0348)

(reserved)		XTS_AES_PHYSICAL_ADDRESS	
31	30	29	0
0x0		0x00000000	
			Reset

XTS_AES_PHYSICAL_ADDRESS Configures physical address. Note that its value should be within the range between 0x0000_0000 and 0x00FF_FFFF). (R/W)

Register 24.5. XTS_AES_DPA_CTRL_REG (0x0388)

(reserved)					XTS_AES_CRYPT_DPA_SELECT_REGISTER			XTS_AES_CRYPT_CALC_D_DPA_EN		XTS_AES_CRYPT_SECURITY_LEVEL	
31					5	4	3	2			
0x00000000					0x0	0x1	0x7				
									Reset		

XTS_AES_CRYPT_DPA_SELECT_REGISTER Configures whether the Anti-DPA function is controlled by eFuse or register.

0: The Anti-DPA function is configured by the register.

1: The Anti-DPA function is configured by eFuse.

(R/W)

XTS_AES_CRYPT_CALC_D_DPA_EN Configures whether to enable Anti-DPA in the XTS_AES algorithm.

0: Enable Anti-DPA only when calculating T

1: Enable Anti-DPA both when calculating T and D

Note that this field is only effective when [XTS_AES_CRYPT_SECURITY_LEVEL](#) is not 0.

(R/W)

XTS_AES_CRYPT_SECURITY_LEVEL Configures the security level of external memory encryption and decryption.

0: Disable the Anti-DPA function

1-7: The bigger the number is, the more secure the encryption and decryption are

(R/W)

Register 24.6. XTS_AES_TRIGGER_REG (0x034C)

31	(reserved)	1	0	
0x00000000				x Reset

XTS_AES_TRIGGER Configures whether or not to enable manual encryption.

0: Disable manual encryption

1: Enable manual encryption

(WO)

Register 24.7. XTS_AES_RELEASE_REG (0x0350)

31	(reserved)	1	0	
0x00000000				x Reset

XTS_AES_RELEASE Configures whether or not to grant SPI1 access to the encrypted result.

0: No effect

1: Grant SPI1 access

(WO)

Register 24.8. XTS_AES_DESTROY_REG (0x0354)

31	(reserved)	1	0	
0x00000000				x Reset

XTS_AES_DESTROY Configures whether or not to destroy the encrypted result.

0: No effect

1: Destroy encrypted result

(WO)

Register 24.9. XTS_AES_STATE_REG (0x0358)

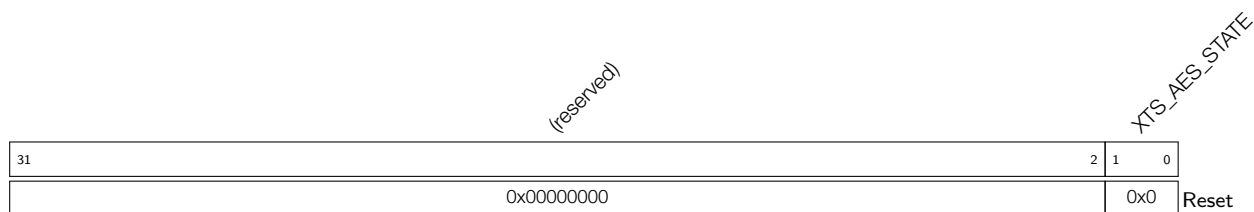

XTS_AES_STATE Represents the status of the Manual Encryption block. 0 (XTS_AES_IDLE): Idle
 1 (XTS_AES_BUSY): Busy with encryption
 2 (XTS_AES_DONE): Encryption completed, but the encrypted result is not accessible to SPI
 3 (XTS_AES_RELEASE): Encrypted result is accessible to SPI
 (RO)

Register 24.10. XTS_AES_DATE_REG (0x035C)

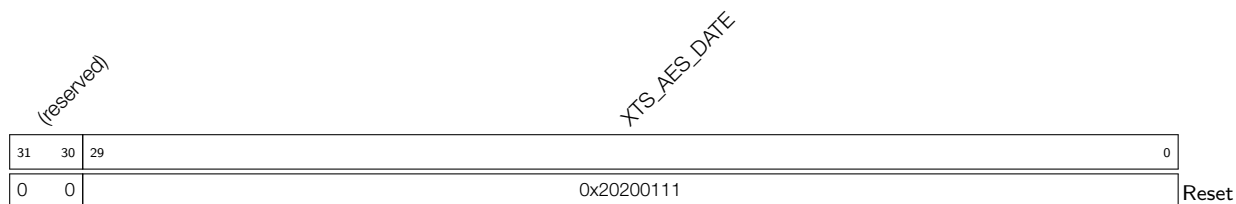

XTS_AES_DATE Version control register. (R/W)

25 Random Number Generator (RNG)

25.1 Introduction

The ESP32-C6 contains a true random number generator, which generates 32-bit random numbers that can be used for cryptographical operations, among other things.

25.2 Features

The random number generator in ESP32-C6 generates true random numbers, which means random numbers generated from a physical process, rather than by means of an algorithm. No number generated within the specified range is more or less likely to appear than any other number.

25.3 Functional Description

Every 32-bit value that the system reads from the `LPPERI_RNG_DATA_REG` register of the random number generator is a true random number. These true random numbers are generated based on the **thermal noise** in the system and the **asynchronous clock mismatch**.

- **Thermal noise** comes from the high-speed ADC or SAR ADC or both. Whenever the high-speed ADC or SAR ADC is enabled, bit streams will be generated and fed into the random number generator through an XOR logic gate as random seeds.
- `RC_FAST_CLK` is an **asynchronous clock** source and it increases the RNG entropy by introducing circuit metastability.

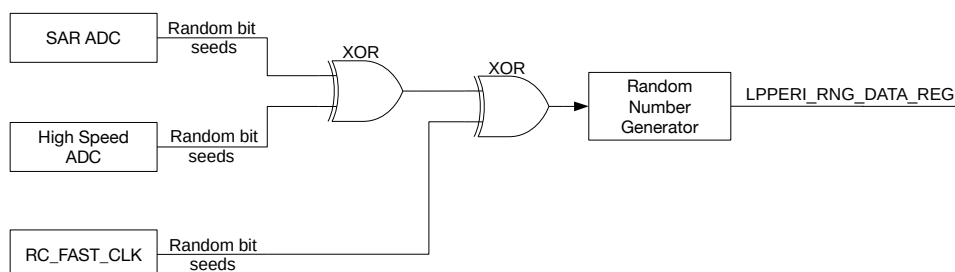

Figure 25-1. Noise Source

When there is noise coming from the SAR ADC, the random number generator is fed with a 2-bit entropy in one clock cycle of `RC_FAST_CLK`, which is generated from an internal RC oscillator (see Chapter 8 *Reset and Clock* for details). Thus, it is advisable to read the `LPPERI_RNG_DATA_REG` register at a maximum rate of 1 MHz to obtain the maximum entropy.

When there is noise coming from the high-speed ADC, the random number generator is fed with a 2-bit entropy in one APB clock cycle, which is normally 80 MHz. Thus, it is advisable to read the `LPPERI_RNG_DATA_REG` register at a maximum rate of 5 MHz to obtain the maximum entropy.

A data sample of 2 GB, which is read from the random number generator at a rate of 5 MHz with only the high-speed ADC being enabled, has been tested using the Dieharder Random Number Test suite (version 3.31.1). The sample passed all tests.

25.4 Programming Procedure

When using the random number generator, make sure at least either the SAR ADC, high-speed ADC¹, or RC_FAST_CLK² is enabled. Otherwise, pseudo-random numbers will be returned.

- SAR ADC can be enabled by using the DIG ADC controller. For details, please refer to Chapter [38 On-Chip Sensor and Analog Signal Processing](#).
- High-speed ADC is enabled automatically when the Wi-Fi or Bluetooth module is enabled.
- RC_FAST_CLK is enabled by setting the [RTC_CNTL_DIG_FOSC_EN](#) bit in the [RTC_CNTL_CLK_CONF_REG](#) register.

Note:

1. Note that, when the Wi-Fi module is enabled, the value read from the high-speed ADC can be saturated in some extreme cases, which lowers the entropy. Thus, it is advisable to also enable the SAR ADC as the noise source for the random number generator for such cases.
2. Enabling RC_FAST_CLK increases the RNG entropy. However, to ensure maximum entropy, it's recommended to always enable an ADC source as well.

When using the random number generator, read the [LPPERI_RNG_DATA_REG](#) register multiple times until sufficient random numbers have been generated. Ensure the rate at which the register is read does not exceed the frequencies described in section [25.3](#) above.

25.5 Register Summary

The abbreviations given in Column **Access** are explained in Section [Access Types for Registers](#).

Name	Description	Address	Access
LPPERI_RNG_DATA_REG	Random number data	0x600B_2808	RO

25.6 Register

Register 25.1. LPPERI_RNG_DATA_REG (0x600B_2808)

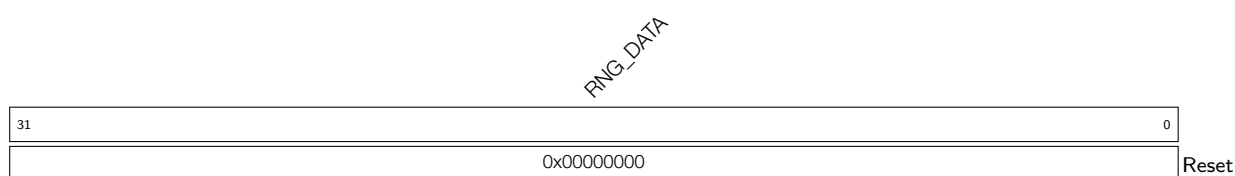

RNG_DATA Random number source. (RO)

26 UART Controller (UART, LP_UART, UHCI)

26.1 Overview

In embedded system applications, data is required to be transferred in a simple way with minimal system resources. This can be achieved by a Universal Asynchronous Receiver/Transmitter (UART), which flexibly exchanges data with other peripheral devices in full-duplex mode. ESP32-C6 has three UART controllers, including two regular UARTs and one low-power LP UART. These UARTs are compatible with various UART devices, and support Infrared Data Association (IrDA) and RS485 communication.

Each of the two regular UART controllers has a group of registers that function identically. In this chapter, the two regular UART controllers are referred to as UART n , in which n denotes 0 or 1. LP UART is the cut-down version of regular UART, with a separate group of registers. For differences between UART and LP UART, please refer to Table 26-1.

A UART is a character-oriented data link for asynchronous communication between devices. Such communication does not add clock signals to the data sent. Therefore, in order to communicate successfully, the transmitter and the receiver must operate at the same baud rate with the same stop bit(s) and a parity bit.

A UART data frame usually begins with one start bit, followed by data bits, one parity bit (optional), and one or more stop bits. UART controllers on ESP32-C6 support various lengths of data bits and stop bits. These controllers also support software and hardware flow control as well as GDMA for high-speed data transfer. This allows developers to use multiple UART ports at minimal software cost.

26.2 Features

Table 26-1 lists the feature comparison between UART and LP UART:

Table 26-1. UART and LP UART Feature Comparison

UART Feature	LP_UART Feature
Programmable baud rate up to 5 MBaud	
132 x 8 bit RAM, shared by TX FIFOs and RX FIFOs of the two UART controllers	20 x 8-bit RAM, shared by the TX FIFO and RX FIFO of LP_UART
Full-duplex asynchronous communication	
Data bits (5 to 8 bits)	
Stop bits (1, 1.5 or 2 bits)	
Parity bit	
Special character AT_CMD detection	
RS485 protocol	—
IrDA protocol	—
High-speed data communication using GDMA	—
Receive timeout	
UART as wake-up source	
Software and hardware flow control	

Cont'd on next page

Table 26-1 – cont'd from previous page

UART Feature	LP_UART Feature
Three prescalable clock sources	Two prescalable clock sources
1. APB_CLK	1. XTAL_CLK
2. XTAL_CLK	2. RC_FAST_CLK
3. RC_FAST_CLK	

The following description mainly covers regular UART controllers.

26.3 UART Structure

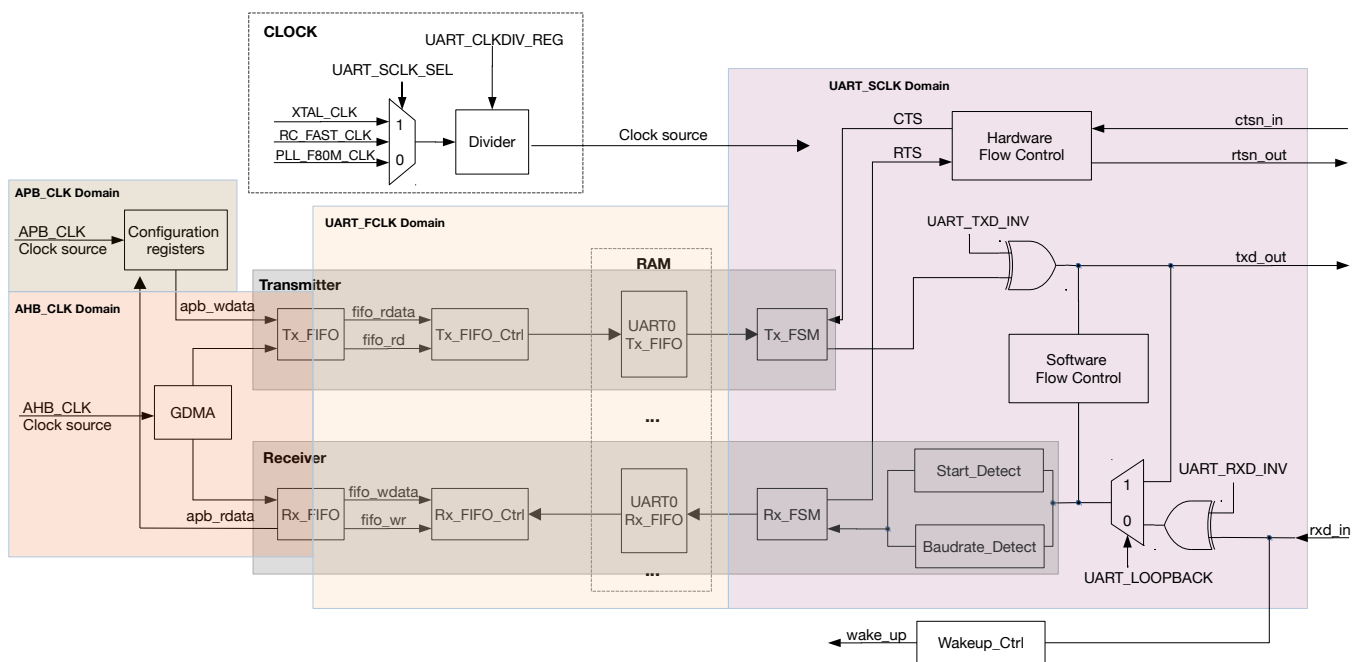

Figure 26-1. UART Structure

Figure 26-1 shows the basic structure of a UART controller. A UART controller works in four clock domains, namely APB_CLK, AHB_CLK, UART_SCLK, and UART_FCLK. APB_CLK and AHB_CLK are synchronized but with different frequencies (APB_CLK is derived from AHB_CLK by division), and likewise UART_SCLK and UART_FCLK are synchronized but with different frequencies (UART_SCLK is derived from UART_FCLK by division). UART_FCLK has three clock sources: an 80 MHz PLL_F80M_CLK, RC_FAST_CLK, and external crystal clock XTAL_CLK (for details, please refer to Chapter 8 *Reset and Clock*), which are selected by configuring `PCR_UARTn_SCLK_SEL`. The selected clock source is divided by a divider to generate UART_SCLK clock signals. The divisor is configured by `PCR_UARTn_SCLK_DIV_NUM` for the integral part, `PCR_UARTn_SCLK_DIV_A` for the denominator of the fractional part, and `PCR_UARTn_SCLK_DIV_B` for the numerator of the fractional part. The divisor ranges from 1 ~ 256.

A UART controller can be broken down into two parts according to functions: a transmitter and a receiver.

The transmitter contains a TX FIFO (i.e. Tx_FIFO in Figure 26-1), which buffers data to be sent. Software can write data to Tx_FIFO via the APB bus, or move data to Tx_FIFO using GDMA. Tx_FIFO_Ctrl controls writing and

reading Tx_FIFO. When Tx_FIFO is not empty, Tx_FSM reads data bits in the data frame via Tx_FIFO_Ctrl, and converts them into a bitstream. The levels of output bitstream signal txd_out can be inverted by configuring the [UART_TXD_INV](#) field.

The receiver contains an RX FIFO (i.e. Rx_FIFO in Figure 26-1), which buffers data to be processed. The input bitstream signal rxd_in is transferred to the UART controller, and its level can be inverted by configuring [UART_RXD_INV](#) field. Baudrate_Detect measures the baud rate of input bitstream signal rxd_in by detecting its minimum pulse width. Start_Detect detects the start bit in a data frame. If the start bit is detected, Rx_FSM stores data bits in the data frame into Rx_FIFO by Rx_FIFO_Ctrl. Software can read data from Rx_FIFO via the APB bus, or receive data using GDMA.

HW_Flow_Ctrl controls rxd_in and txd_out data flows by standard UART RTS and CTS flow control signals (rtsn_out and ctsn_in). SW_Flow_Ctrl controls data flows by adding special characters to outgoing data and detecting special characters in incoming data. When a UART controller is Light-sleep mode (see Chapter 2 [Low-Power Management \[to be added later\]](#) for more details), a wake_up signal can be generated in four ways and sent to RTC, which then wakes up the ESP32-C6 chip. For more information about wakeup, please refer to Section 26.4.8.

26.4 Functional Description

26.4.1 Clock and Reset

UART controllers are asynchronous. Their register configuration module works in the APB_CLK domain. TX FIFO and RX FIFO work across the AHB_CLK and UART_FCLK domains. The UART RAM control unit works in the UART_FCLK domain. The UART transmission and reception control module works in the UART_SCLK domain, i.e. UART Core's clock domain.

When the frequency of the UART_SCLK is higher than the frequency needed to generate the baud rate, the UART Core can be clocked at a lower frequency by the divider, in order to reduce power consumption. Usually, the UART Core's clock frequency is lower than the APB_CLK's frequency, and can be divided by the largest divisor when higher than the frequency needed to generate the baud rate. The frequency of the UART Core's clock can also be at most twice higher than the APB_CLK. The clock for the UART transmitter and the UART receiver can be controlled independently. To enable the clock for the UART transmitter, [UART_TX_SCLK_EN](#) shall be set; to enable the clock for the UART receiver, [UART_RX_SCLK_EN](#) shall be set.

To ensure that the configured register values are synchronized from APB_CLK domain to the UART Core's clock domain, please follow the procedures in Section 26.5.

To reset the whole UART, please:

- Enable the UART Core's clock by setting [PCR_UART \$n\$ _CLK_EN](#) to 1.
- Write 1 to [PCR_UART \$n\$ _RST_EN](#).
- Clear [PCR_UART \$n\$ _RST_EN](#) to 0.

26.4.2 UART FIFO

The two UART controllers on ESP32-C6 instantiate a 256 × 8 bits RAM respectively. They access the RAM via a 4 × 8 bits asynchronous FIFO interface with a fixed address. In other words, two UART controllers have a 132 × 8 bits FIFO in total.

UART0 Tx_FIFO and UART1 Tx_FIFO are reset by setting [UART_TXFIFO_RST](#). UART0 Rx_FIFO and UART1 Rx_FIFO are reset by setting [UART_RXFIFO_RST](#).

Data to be sent is written to TX FIFO via the APB bus or using GDMA, read automatically, and converted from a frame into a bitstream by hardware Tx_FSM. Data received is converted from a bitstream into a frame by hardware Rx_FSM, written into RX FIFO, and then stored into RAM via the APB bus or using GDMA. The two UART controllers share one GDMA channel.

The empty signal threshold for Tx_FIFO is configured by setting [UART_TXFIFO_EMPTY_THRHD](#). When data stored in Tx_FIFO is less than [UART_TXFIFO_EMPTY_THRHD](#), a [UART_TXFIFO_EMPTY_INT](#) interrupt is generated. The full signal threshold for Rx_FIFO is configured by setting [UART_RXFIFO_FULL_THRHD](#). When data stored in Rx_FIFO is greater than [UART_RXFIFO_FULL_THRHD](#), a [UART_RXFIFO_FULL_INT](#) interrupt is generated. In addition, when Rx_FIFO receives more data than its capacity, a [UART_RXFIFO_OVF_INT](#) interrupt is generated.

UART n can access FIFO via register [UART_FIFO_REG](#). You can put data into TX FIFO by writing [UART_RXFIFO_RD_BYTE](#), and get data in RX FIFO by reading [UART_RXFIFO_RD_BYTE](#).

26.4.3 Baud Rate Generation and Detection

26.4.3.1 Baud Rate Generation

Before a UART controller sends or receives data, the baud rate should be configured by setting corresponding registers. The baud rate generator of a UART controller functions by dividing the input clock source. It can divide the clock source by a fractional amount. The divisor is configured by `UART_CLKDIV_SYNC_REG`:

`UART_CLKDIV` for the integral part, and `UART_CLKDIV_FRAG` for the fractional part. When using the 80 MHz input clock, the UART controller supports a maximum baud rate of 5 Mbaud.

The divisor of the baud rate divider is equal to

$$UART_CLKDIV + \frac{UART_CLKDIV_FRAG}{16}$$

meaning that the final baud rate is equal to

$$\frac{INPUT_FREQ}{UART_CLKDIV + \frac{UART_CLKDIV_FRAG}{16}}$$

where `INPUT_FREQ` is the frequency of UART Core's source clock. For example, if `UART_CLKDIV` = 694 and `UART_CLKDIV_FRAG` = 7, then the divisor value is

$$694 + \frac{7}{16} = 694.4375$$

When `UART_CLKDIV_FRAG` is 0, the baud rate generator is an integer clock divider where an output pulse is generated every `UART_CLKDIV` input pulses.

When `UART_CLKDIV_FRAG` is not 0, the divider is fractional and the output baud rate clock pulses are not strictly uniform. As shown in Figure 26-2, for every 16 output pulses, the generator divides either (`UART_CLKDIV` + 1) input pulses or `UART_CLKDIV` input pulses per output pulse. A total of `UART_CLKDIV_FRAG` output pulses are generated by dividing (`UART_CLKDIV` + 1) input pulses, and the remaining (`16 - UART_CLKDIV_FRAG`) output pulses are generated by dividing `UART_CLKDIV` input pulses.

The output pulses are interleaved as shown in Figure 26-2 below, to make the output timing more uniform:

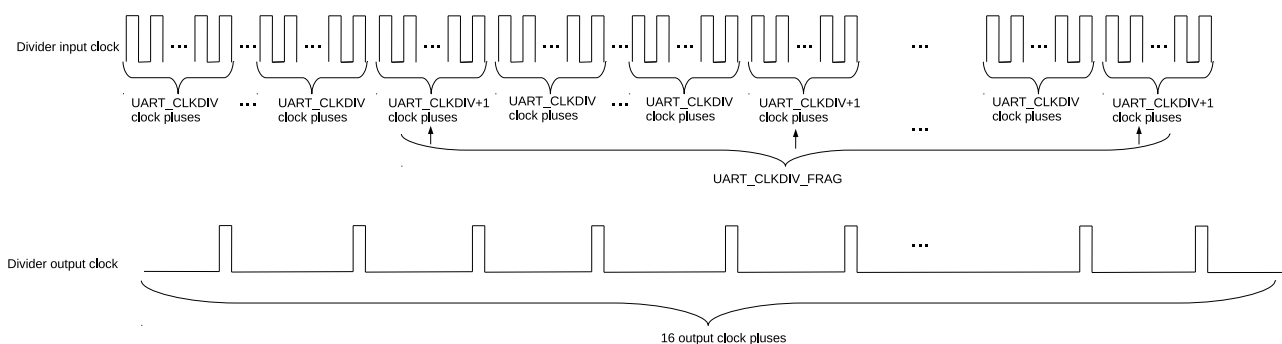

Figure 26-2. UART Controllers Division

To support IrDA (see Section 26.4.7 for details), the fractional clock divider for IrDA data transmission generates clock signals divided by $16 \times \text{UART_CLKDIV_SYNC_REG}$. This divider works similarly as the one elaborated above: it takes `UART_CLKDIV/16` as the integer value and the lowest four bits of `UART_CLKDIV` as the fractional value.

26.4.3.2 Baud Rate Detection

Automatic baud rate detection (Autobaud) on UARTs is enabled by setting `UART_AUTOBAUD_EN`. The Baudrate_Detect module shown in Figure 26-1 filters any noise whose pulse width is shorter than `UART_GLITCH_FILT`.

Before communication starts, the transmitter could send random data to the receiver for baud rate detection. `UART_LOWPULSE_MIN_CNT` stores the minimum low pulse width, `UART_HIGHPULSE_MIN_CNT` stores the minimum high pulse width, `UART_POSEDGE_MIN_CNT` stores the minimum pulse width between two rising edges, and `UART_NEGEDGE_MIN_CNT` stores the minimum pulse width between two falling edges. These four fields are read by software to determine the transmitter's baud rate.

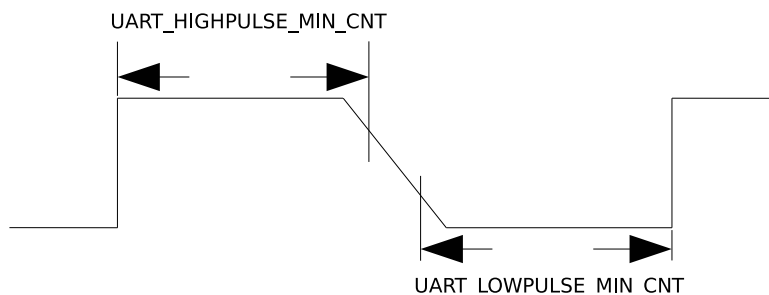

Figure 26-3. The Timing Diagram of Weak UART Signals Along Falling Edges

The baud rate can be determined in the following three ways:

1. Normally, to avoid sampling erroneous data along rising or falling edges in a metastable state, which results in the inaccuracy of `UART_LOWPULSE_MIN_CNT` or `UART_HIGHPULSE_MIN_CNT`, use a weighted average of these two values to eliminate errors for 1-bit pulses. In this case, the baud rate is calculated as follows:

$$B_{\text{uart}} = \frac{f_{\text{clk}}}{(\text{UART_LOWPULSE_MIN_CNT} + \text{UART_HIGHPULSE_MIN_CNT} + 2)/2}$$

2. If UART signals are weak along falling edges as shown in Figure 26-3, which leads to an inaccurate average of `UART_LOWPULSE_MIN_CNT` and `UART_HIGHPULSE_MIN_CNT`, use `UART_POSEDGE_MIN_CNT` to determine the transmitter's baud rate as follows:

$$B_{\text{uart}} = \frac{f_{\text{clk}}}{(\text{UART_POSEDGE_MIN_CNT} + 1)/2}$$

3. If UART signals are weak along rising edges, use `UART_NEGEDGE_MIN_CNT` to determine the transmitter's baud rate as follows:

$$B_{\text{uart}} = \frac{f_{\text{clk}}}{(\text{UART_NEGEDGE_MIN_CNT} + 1)/2}$$

26.4.4 UART Data Frame

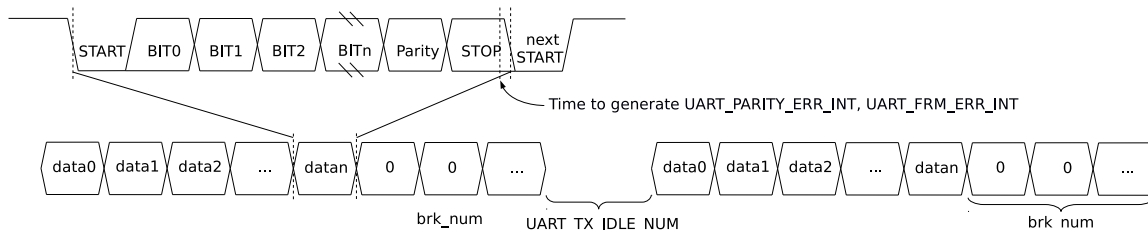

Figure 26-4. Structure of UART Data Frame

Figure 26-4 shows the basic structure of a data frame. A frame starts with one start bit, and ends with stop bits which can be 1, 1.5 or 2 bits long, configured by `UART_STOP_BIT_NUM` (in RS485 mode turnaround delay may be added. See details in Section 26.4.6.2). The start bit is logical low, whereas stop bits are logical high.

The actual data length can be anywhere between 5 ~ 8 bit, configured by `UART_BIT_NUM`. When `UART_PARITY_EN` is set, a parity bit is added after data bits. `UART_PARITY` is used to choose even parity or odd parity. When the receiver detects a parity bit error in the data received, a `UART_PARITY_ERR_INT` interrupt is generated, and the data received will still be stored into RX FIFO. When the receiver detects a data frame error, a `UART_FRM_ERR_INT` interrupt is generated, and the data received by default is stored into RX FIFO.

If all data in `Tx_FIFO` has been sent, a `UART_TX_DONE_INT` interrupt is generated. After this, if the `UART_TXD_BRK` bit is set, then the transmitter will enter the Break condition and send several NULL characters in which the TX data line is logical low. The number of NULL characters is configured by `UART_TX_BRK_NUM`. Once the transmitter has sent all NULL characters, a `UART_TX_BRK_DONE_INT` interrupt is generated. The minimum interval between data frames can be configured using `UART_TX_IDLE_NUM`. If the transmitter stays idle for `UART_TX_IDLE_NUM` or more time, a `UART_TX_BRK_IDLE_DONE_INT` interrupt is generated.

The receiver can also detect the Break conditions when the RX data line remains logical low for one NULL character transmission, and a `UART_BRK_DET_INT` interrupt will be triggered to detect that a Break condition has been completed.

The receiver can detect the current bus state through the timeout interrupt `UART_RXFIFO_TOUT_INT`. The `UART_RXFIFO_TOUT_INT` interrupt will be triggered when the bus is in the idle state for more than `UART_RX_TOUT_THRHD` bit time on current baud rate after the receiver has received at least one byte. You can use this interrupt to detect whether all the data from the transmitter has been sent.

26.4.5 AT_CMD Character Structure

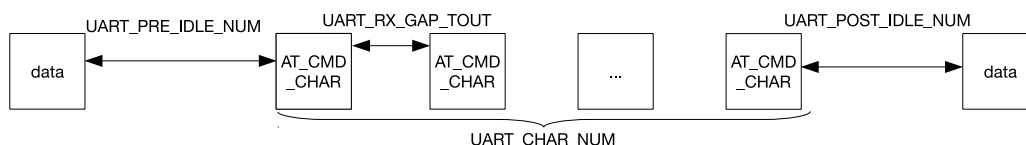

Figure 26-5. AT_CMD Character Structure

Figure 26-5 is the structure of a special character `AT_CMD`. If the receiver constantly receives `AT_CMD_CHAR` and the following conditions are met, a `UART_AT_CMD_CHAR_DET_INT` interrupt is generated.

- The interval between the first AT_CMD_CHAR and the last non-AT_CMD_CHAR character is at least `UART_PRE_IDLE_NUM` cycles.
- The interval between two AT_CMD_CHAR characters is less than `UART_RX_GAP_TOUT` in the unit of baud rate cycles.
- The number of AT_CMD_CHAR characters is equal to or greater than `UART_CHAR_NUM`.
- The interval between the last AT_CMD_CHAR character and next non-AT_CMD_CHAR character is at least `UART_POST_IDLE_NUM` cycles.

Note: Given that the interval between AT_CMD_CHAR characters is less than `UART_RX_GAP_TOUT` in the unit of baud rate cycles, the APB_CLK frequency is suggested not to be lower than 8 MHz.

26.4.6 RS485

The two regular UART controllers support RS485 communication mode. In this mode differential signals are used to transmit data, so it can communicate over longer distances at higher bit rates than RS232. RS485 has two-wire half-duplex and four-wire full-duplex options. UART controllers support two-wire half-duplex transmission and bus snooping.

26.4.6.1 Driver Control

As shown in Figure 26-6, in a two-wire multidrop network, an external RS485 transceiver is needed for differential to single-ended conversion or the other way around. An RS485 transceiver contains a driver and a receiver. When a UART controller is not in transmitter mode, the connection to the differential line can be broken by disabling the driver. When DE is 1, the driver is enabled; when DE is 0, the driver is disabled.

The UART receiver converts differential signals to single-ended signals via an external receiver. RE is the enable control signal for the receiver. When RE is 0, the receiver is enabled; when RE is 1, the receiver is disabled. If RE is configured as 0, the UART controller is allowed to snoop data on the bus, including the data sent by itself.

DE can be controlled by either software or hardware. To reduce the cost of software, in our design DE is controlled by hardware. As shown in Figure 26-6, DE is connected to `dtrn_out` of UART (please refer to Section 26.4.9.1 for more details).

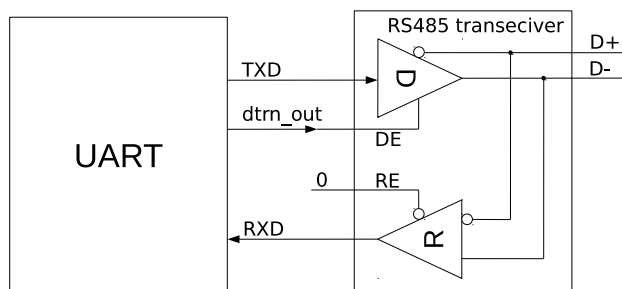

Figure 26-6. Driver Control Diagram in RS485 Mode

26.4.6.2 Turnaround Delay

By default, the two UART controllers work in receiver mode. When a UART controller is switched from transmitter mode to receiver mode, the RS485 protocol requires a turnaround delay of one cycle after the stop bit. The UART transmitter supports adding a turnaround delay of one cycle before the start bit or after the stop bit. When

`UART_DLO_EN` is set, a turnaround delay of one cycle is added before the start bit; when `UART_DL1_EN` is set, a turnaround delay of one cycle is added after the stop bit.

26.4.6.3 Bus Snooping

In a two-wire multidrop network, UART controllers support bus snooping if RE of the external RS485 transceiver is 0. By default, a UART controller is not allowed to transmit and receive data simultaneously. If `UART_RS485TX_RX_EN` is set and the external RS485 transceiver is configured as in Figure 26-6, a UART controller may receive data in transmitter mode and snoop the bus. If `UART_RS485RXBY_TX_EN` is set, a UART controller may transmit data in receiver mode.

The two UART controllers can snoop the data sent by themselves. In transmitter mode, when a UART controller monitors a collision between the data sent and the data received, a `UART_RS485_CLASH_INT` is generated; when a UART controller monitors a data frame error, a `UART_RS485_FRM_ERR_INT` interrupt is generated; when a UART controller monitors a polarity error, a `UART_RS485_PARITY_ERR_INT` is generated.

26.4.7 IrDA

IrDA protocol consists of three layers, namely the physical layer, the link access protocol, and the link management protocol. The two UART controllers implement IrDA's physical layer. In IrDA encoding, a UART controller supports data rates up to 115.2 kbit/s (SIR, or serial infrared mode). As shown in Figure 26-7, the IrDA encoder converts a non-return to zero code (NRZ) signal to a return to zero inverted code (RZI) signal and sends it to the external driver and infrared LED. This encoder uses modulated signals whose pulse width is 3/16 bits to indicate logic “0”, and low levels to indicate logic “1”. The IrDA decoder receives signals from the infrared receiver and converts them to NRZ signals. In most cases, the receiver is high when it is idle, and the encoder output polarity is the opposite of the decoder input polarity. If a low pulse is detected, it indicates that a start bit has been received.

When IrDA function is enabled, one bit is divided into 16 clock cycles. If the bit to be sent is zero, then the 9th, 10th, and 11th clock cycle are high.

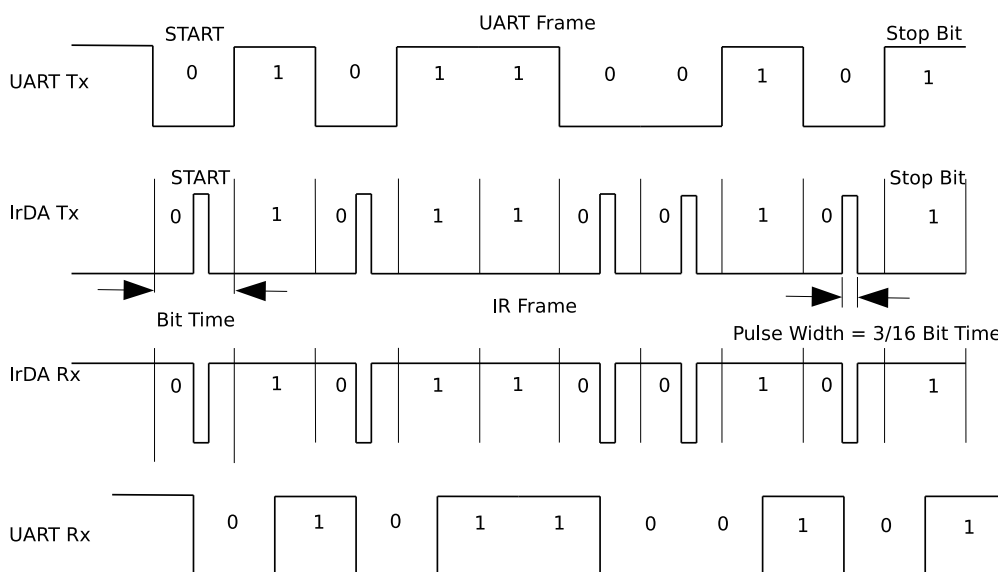

Figure 26-7. The Timing Diagram of Encoding and Decoding in SIR mode

The IrDA transceiver is half-duplex, meaning that it cannot send and receive data simultaneously. As shown in

Figure 26-8, IrDA function is enabled by setting `UART_IRDA_EN`. When `UART_IRDA_TX_EN` is set to 1, the IrDA transceiver is enabled to send data and not allowed to receive data; when `UART_IRDA_TX_EN` is reset to 0, the IrDA transceiver is enabled to receive data and not allowed to send data.

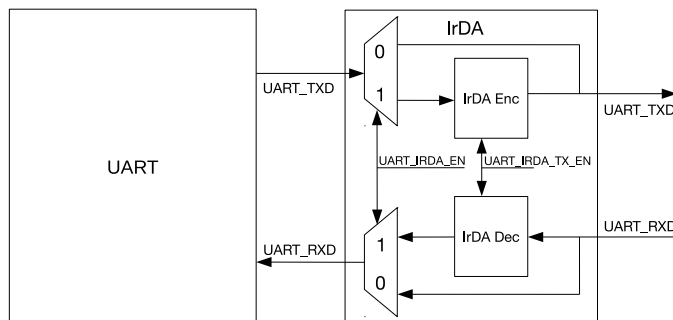

Figure 26-8. IrDA Encoding and Decoding Diagram

26.4.8 Wake-up

UART can be set as wake-up source. When a UART controller is in Light-sleep mode, a wake_up signal can be generated in four ways and be sent to the RTC module, which then wakes up ESP32-C6.

- `UART_WK_MODE_SEL = 0`: When all the clocks are disabled, the chip can be woken up by reverting RXD for multiple cycles until the number of rising edges is greater than `UART_ACTIVE_THRESHOLD`.
- `UART_WK_MODE_SEL = 1`: UART Core keeps working, so the UART receiver can still receive data and store the received data in RX FIFO. When the number of data bytes in RX FIFO is greater than `UART_RX_WAKE_UP_THRHD`, the chip can be woken up from the Light-sleep mode.
- `UART_WK_MODE_SEL = 2`: When the UART receiver detects a start bit, the chip will be woken up.
- `UART_WK_MODE_SEL = 3`: When the UART receiver receives a specific character sequence, the chip will be woken up. The wakeup characters can be defined by configuring `UART_WK_CHAR0`, `UART_WK_CHAR1`, `UART_WK_CHAR2`, `UART_WK_CHAR3`, and `UART_WK_CHAR4`. These four characters can be formed into different character sequences by configuring `UART_CHAR_NUM` and `UART_WK_CHAR_MASK`, as shown in Table 26-2. Once the sequence is detected, the chip will be woken up. For the last configuration in Table 26-2, UART will detects for CHAR0 ~ CHAR4 in order.

Table 26-2. UART_CHAR_WAKEUP Mode Configuration

UART_CHAR_NAME	UART_WP_CHAR_MASK	Character Sequence
1	0xF	CHAR4
2	0x7	CHAR3/CHAR4
3	0x3	CHAR2/CHAR3/CHAR4
4	0x1	CHAR1/CHAR2/CHAR3/CHAR4
5	0x0	CHAR0/CHAR1/CHAR2/CHAR3/CHAR4

26.4.9 Flow Control

UART controllers have two ways to control data flow, namely hardware flow control and software flow control. Hardware flow control is achieved using output signal `rtsn_out` and input signal `ctsn_in`. Software flow control is

achieved by inserting special characters in the data flow sent and detecting special characters in the data flow received.

26.4.9.1 Hardware Flow Control

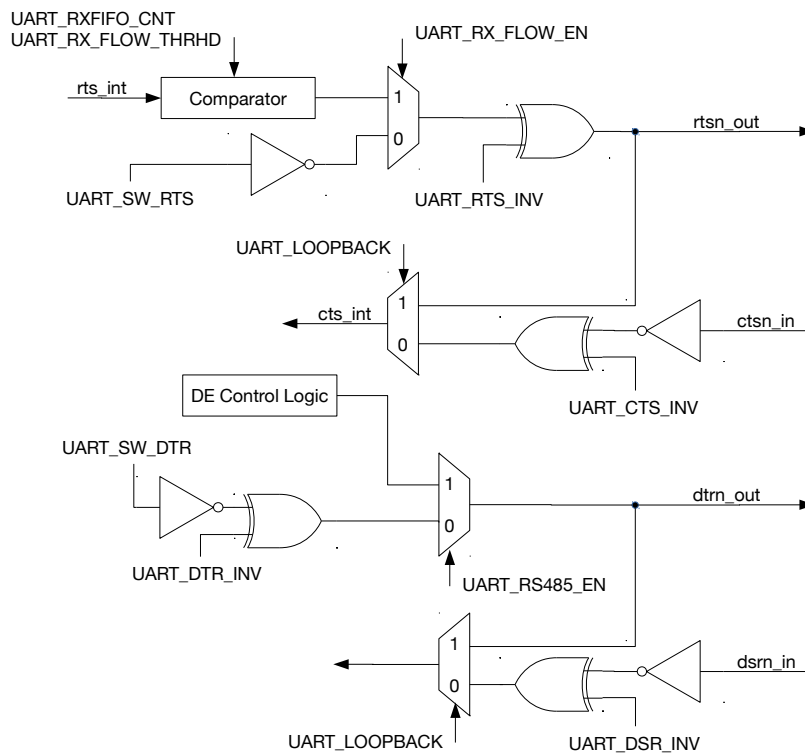

Figure 26-9. Hardware Flow Control Diagram

Figure 26-9 shows the hardware flow control of a UART controller. Hardware flow control uses output signal `rtsn_out` and input signal `dsrn_in`. Figure 26-10 illustrates how these signals are connected between UART on ESP32-C6 (hereinafter referred to as IU0) and the external UART (hereinafter referred to as EU0).

When `rtsn_out` of IU0 is low, EU0 is allowed to send data. When `rtsn_out` of IU0 is high, EU0 is notified to stop sending data until `rtsn_out` of IU0 returns to low. The output signal `rtsn_out` can be controlled in two ways.

- Software control: Enter this mode by clearing `UART_RX_FLOW_EN` to 0. In this mode, the level of `rtsn_out` is changed by configuring `UART_SW_RTS`.
- Hardware control: Enter this mode by setting `UART_RX_FLOW_EN` to 1. In this mode, `rtsn_out` is pulled high when data in `Rx_FIFO` exceeds `UART_RX_FLOW_THRHD`.

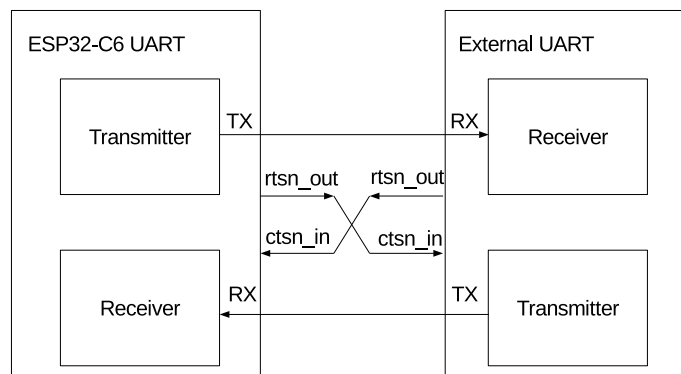

Figure 26-10. Connection between Hardware Flow Control Signals

When `ctsn_in` of IU0 is low, IU0 is allowed to send data; when `ctsn_in` is high, IU0 is not allowed to send data. When IU0 detects an edge change of `ctsn_in`, a `UART_CTS_CHG_INT` interrupt is generated.

If `dtrn_out` of IU0 is high, it indicates that IU0 is ready to transmit data. `dtrn_out` is generated by configuring the `UART_SW_DTR` field. When the IU0 transmitter detects an edge change of `dsrn_in`, a `UART_DSR_CHG_INT` interrupt is generated. After this interrupt is detected, software can obtain the level of input signal `dsrn_in` by reading `UART_DSRN`. If `dsrn_in` is high, it indicates that EU0 is ready to transmit data.

In a two-wire RS485 multidrop network enabled by setting `UART_RS485_EN`, `dtrn_out` is generated by hardware and used for transmit/receive turnaround. When data transmission starts, `dtrn_out` is pulled high and the external driver is enabled; when data transmission completes, `dtrn_out` is pulled low and the external driver is disabled. Please note that when there is a turnaround delay of one cycle added after the stop bit, `dtrn_out` is pulled low after the delay.

UART loopback test is enabled by setting `UART_LOOPBACK`. In the test, UART output signal `txd_out` is connected to its input signal `rxd_in`, `rtsn_out` is connected to `ctsn_in`, and `dtrn_out` is connected to `dsrn_out`. If the data sent matches the data received, it indicates that UART controllers are working properly.

26.4.9.2 Software Flow Control

Instead of CTS/RTS lines, software flow control uses XON/XOFF characters to start or stop data transmission. Such flow control is enabled by setting `UART_SW_FLOW_CON_EN` to 1.

When using software flow control, hardware automatically detects if there are XON/XOFF characters in the data flow received, and generate a `UART_SW_XOFF_INT` or a `UART_SW_XON_INT` interrupt accordingly. If an XOFF character is detected, the transmitter stops data transmission once the current byte has been transmitted; if an XON character is detected, the transmitter starts data transmission. In addition, software can force the transmitter to stop sending data by setting `UART_FORCE_XOFF`, or to start sending data by setting `UART_FORCE_XON`.

Software determines whether to insert flow control characters according to the remaining room in RX FIFO. When `UART_SEND_XOFF` is set, the transmitter sends an XOFF character configured by `UART_XOFF_CHAR` after the current byte in transmission; when `UART_SEND_XON` is set, the transmitter sends an XON character configured by `UART_XON_CHAR` after the current byte in transmission. If the RX FIFO of a UART controller stores more data than `UART_XOFF_THRESHOLD`, `UART_SEND_XOFF` is set by hardware. As a result, the transmitter sends an

XOFF character configured by `UART_XOFF_CHAR` after the current byte in transmission. If the RX FIFO of a UART controller stores less data than `UART_XON_THRESHOLD`, `UART_SEND_XON` is set by hardware. As a result, the transmitter sends an XON character configured by `UART_XON_CHAR` after the current byte in transmission.

In full-duplex mode, when the UART receiver receives an XOFF character, the UART transmitter is not allowed to send any data including XOFF even if the UART receiver receives more data than its threshold. To avoid deadlocks in software flow control or overflow caused thereby, you can set `UART__XON_XOFF_STILL_SEND`. In this way, the UART transmitter can still send an XOFF character when it is not allowed to send any data.

26.4.10 GDMA Mode

The two UART controllers on ESP32-C6 share one TX/RX GDMA (general direct memory access) channel via UHCI. In GDMA mode, UART controllers support the decoding and encoding of HCI data packets. The `UHCI_UART n _CE` field determines which UART controller occupies the GDMA TX/RX channel.

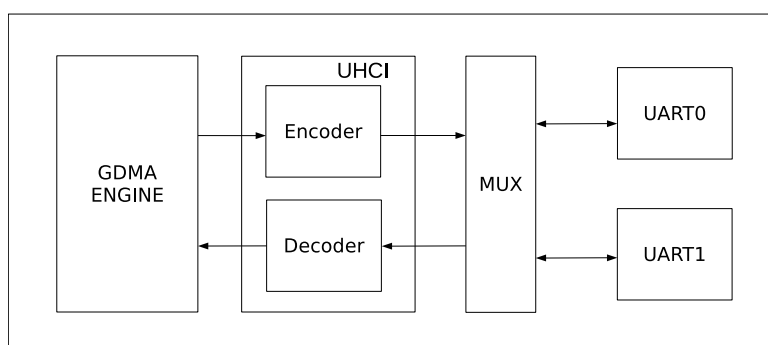

Figure 26-11. Data Transfer in GDMA Mode

Figure 26-11 shows how data is transferred using GDMA. Before GDMA receives data, software prepares an inlink. `GDMA_INLINK_ADDR_CH n` points to the first receive descriptor in the inlink. After `GDMA_INLINK_START_CH n` is set, UHCI sends data that UART has received to the decoder. The decoded data is then stored into the RAM pointed by the inlink under the control of GDMA.

Before GDMA sends data, software prepares an outlink and data to be sent. `GDMA_OUTLINK_ADDR_CH n` points to the first transmit descriptor in the outlink. After `GDMA_OUTLINK_START_CH n` is set, GDMA reads data from the RAM pointed by outlink. The data is then encoded by the encoder, and sent sequentially by the UART transmitter.

HCI data packets have separators at the beginning and the end, with data bits in the middle (separators + data bits + separators). The encoder inserts separators in front of and after data bits, and replaces data bits identical to separators with special characters. The decoder removes separators in front of and after data bits, and replaces special characters with separators. There can be more than one continuous separator at the beginning and the end of a data packet. The separator is configured by `UHCI_SEPER_CHAR`, 0xC0 by default. The special character is configured by `UHCI_ESC_SEQ0_CHAR0` (0xDB by default) and `UHCI_ESC_SEQ0_CHAR1` (0xDD by default). When all data has been sent, a `GDMA_OUT_TOTAL_EOF_CH n _INT` interrupt is generated. When all data has been received, a `GDMA_IN_SUC_EOF_CH n _INT` is generated.

26.4.11 UART Interrupts

- `UART_AT_CMD_CHAR_DET_INT`: Triggered when the receiver detects an AT_CMD character.

- `UART_RS485_CLASH_INT`: Triggered when a collision is detected between the transmitter and the receiver in RS485 mode.
- `UART_RS485_FRM_ERR_INT`: Triggered when an error is detected in the data frame sent by the transmitter in RS485 mode.
- `UART_RS485_PARITY_ERR_INT`: Triggered when an error is detected in the parity bit sent by the transmitter in RS485 mode.
- `UART_TX_DONE_INT`: Triggered when all data in the transmitter's TX FIFO has been sent.
- `UART_TX_BRK_IDLE_DONE_INT`: Triggered when the transmitter stays idle for the minimum interval (threshold) after sending the last data bit.
- `UART_TX_BRK_DONE_INT`: Triggered when the transmitter has sent all NULL characters after all data in TX FIFO had been sent.
- `UART_GLITCH_DET_INT`: Triggered when the receiver detects a glitch in the middle of the start bit.
- `UART_SW_XOFF_INT`: Triggered when `UART_SW_FLOW_CON_EN` is set and the receiver receives a XOFF character.
- `UART_SW_XON_INT`: Triggered when `UART_SW_FLOW_CON_EN` is set and the receiver receives a XON character.
- `UART_RXFIFO_TOUT_INT`: Triggered when the receiver takes more time than `UART_RX_TOUT_THRHD` to receive one byte.
- `UART_BRK_DET_INT`: Triggered when the receiver detects a NULL character (i.e. logic 0 for one NULL character transmission) after stop bits.
- `UART_CTS_CHG_INT`: Triggered when the receiver detects an edge change of CTS_n signals.
- `UART_DSR_CHG_INT`: Triggered when the receiver detects an edge change of DSR_n signals.
- `UART_RXFIFO_OVF_INT`: Triggered when the receiver has received at least one byte, and the bus remains idle for `UART_RX_TOUT_THRHD` bit time.
- `UART_FRM_ERR_INT`: Triggered when the receiver detects a data frame error.
- `UART_PARITY_ERR_INT`: Triggered when the receiver detects a parity error.
- `UART_TXFIFO_EMPTY_INT`: Triggered when TX FIFO stores less data than what `UART_TXFIFO_EMPTY_THRHD` specifies.
- `UART_RXFIFO_FULL_INT`: Triggered when the receiver receives more data than what `UART_RXFIFO_FULL_THRHD` specifies.
- `UART_WAKEUP_INT`: Triggered when UART is woken up.

26.4.12 UHCI Interrupts

- `UHCI_APP_CTRL1_INT`: Triggered when software sets `UHCI_APP_CTRL1_INT_RAW`.
- `UHCI_APP_CTRL0_INT`: Triggered when software sets `UHCI_APP_CTRL0_INT_RAW`.
- `UHCI_OUTLINK_EOF_ERR_INT`: Triggered when an EOF error is detected in a transmit descriptor.
- `UHCI_SEND_A_REG_Q_INT`: Triggered when UHCI has sent a series of short packets using `always_send`.

- UHCI_SEND_S_REG_Q_INT: Triggered when UHCI has sent a series of short packets using `single_send`.
- UHCI_TX_HUNG_INT: Triggered when UHCI takes too long to read RAM using a GDMA transmit channel.
- UHCI_RX_HUNG_INT: Triggered when UHCI takes too long to receive data using a GDMA receive channel.
- UHCI_TX_START_INT: Triggered when GDMA detects a separator character.
- UHCI_RX_START_INT: Triggered when a separator character has been sent.

26.5 Programming Procedures

26.5.1 Register Type

All UART registers are in the APB_CLK domain.

UART configuration registers can be classified into two groups. One group of registers are read in APB_CLK or AHB_CLK domains, so once such registers are configured no extra operations are required. The other group of registers are read in the UART Core's clock domain, and therefore need to implement the clock domain crossing design. Once these registers are configured, the configured values need to be synchronized to the UART Core's clock domain by writing to `UART_REG_UPDATE`. Once all values have been synchronized, `UART_REG_UPDATE` will be automatically cleared by hardware. After configuring registers that need synchronization, it is recommended to check whether `UART_REG_UPDATE` is 0. This is to ensure that register values configured before have already been synchronized.

To distinguish between these two groups of registers easily, all registers that implement the clock domain crossing design have the `_SYNC` suffix, and are put together in Section 26.6. Those without the `_SYNC` suffix in Section 26.6 are configuration registers that require no clock domain crossing.

26.5.2 Detailed Steps

Figure 26-12 illustrates the process to program UART controllers, namely initialize UART, configure registers, enable the UART transmitter or receiver, and finish data transmission.

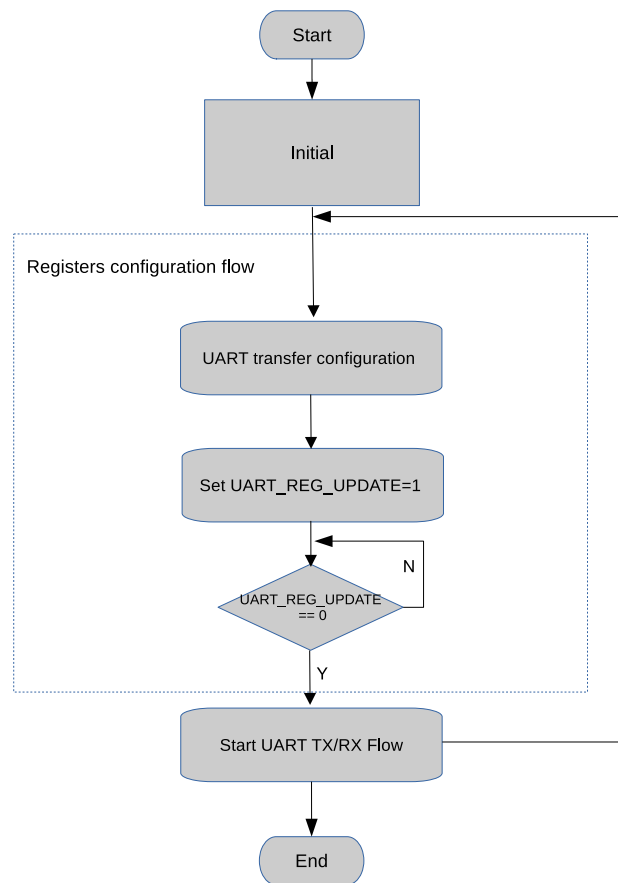

Figure 26-12. UART Programming Procedures

26.5.2.1 Initializing UART n

To initialize UART n :

- Write 1 to `PCR_UART n _RST_EN`.
- Clear `PCR_UART n _RST_EN`.

26.5.2.2 Configuring UART n Communication

To configure UART n communication:

- Wait for `UART_REG_UPDATE` to become 0, which indicates the completion of the last synchronization.
- Select the clock source via `PCR_UART n _SCLK_SEL`.
- Configure divisor of the divider via `PCR_UART n _SCLK_DIV_NUM`, `PCR_UART n _SCLK_DIV_A`, and `PCR_UART n _SCLK_DIV_B`.
- Configure the baud rate for transmission via `UART_CLKDIV` and `UART_CLKDIV_FRAG`.
- Configure data length via `UART_BIT_NUM`.
- Configure odd or even parity check via `UART_PARITY_EN` and `UART_PARITY`.
- Optional steps depending on application ...
- Synchronize the configured values to the Core Clock domain by writing 1 to `UART_REG_UPDATE`.

26.5.2.3 Enabling UART n

To enable UART n transmitter:

- Configure TX FIFO's empty threshold via [UART_TXFIFO_EMPTY_THRHD](#).
- Disable UART_TXFIFO_EMPTY_INT interrupt by clearing [UART_TXFIFO_EMPTY_INT_ENA](#).
- Write data to be sent to [UART_RXFIFO_RD_BYTE](#).
- Clear UART_TXFIFO_EMPTY_INT interrupt by setting [UART_TXFIFO_EMPTY_INT_CLR](#).
- Enable UART_TXFIFO_EMPTY_INT interrupt by setting [UART_TXFIFO_EMPTY_INT_ENA](#).
- Check [UART_TXFIFO_EMPTY_INT_ST](#) and wait for the completion of data transmission.

To enable UART n receiver:

- Configure RX FIFO's full threshold via [UART_RXFIFO_FULL_THRHD](#).
- Enable UART_RXFIFO_FULL_INT interrupt by setting [UART_RXFIFO_FULL_INT_ENA](#).
- Check [UART_RXFIFO_FULL_INT_ST](#) and wait until the RX FIFO is full.
- Read data from RX FIFO via [UART_RXFIFO_RD_BYTE](#), and obtain the number of bytes received in RX FIFO via [UART_RXFIFO_CNT](#).

26.6 Register Summary

26.6.1 UART Register Summary

The addresses in this section are relative to UART Controller base address provided in Table 5-2 in Chapter 5 *System and Memory*.

The abbreviations given in Column **Access** are explained in Section *Access Types for Registers*.

Name	Description	Address	Access
FIFO Configuration			
UART_FIFO_REG	FIFO data register	0x0000	RO
UART_TOUT_CONF_SYNC_REG	UART threshold and allocation configuration	0x0064	R/W
UART Interrupt Register			
UART_INT_RAW_REG	Raw interrupt status	0x0004	R/WTC/SS
UART_INT_ST_REG	Masked interrupt status	0x0008	RO
UART_INT_ENA_REG	Interrupt enable bits	0x000C	R/W
UART_INT_CLR_REG	Interrupt clear bits	0x0010	WT
Configuration Register			
UART_CLKDIV_SYNC_REG	Clock divider configuration	0x0014	R/W
UART_RX_FILT_REG	RX filter configuration	0x0018	R/W
UART_CONF0_SYNC_REG	Configuration register 0	0x0020	R/W
UART_CONF1_REG	Configuration register 1	0x0024	R/W
UART_HWFC_CONF_SYNC_REG	Hardware flow control configuration	0x002C	R/W
UART_SLEEP_CONF0_REG	UART sleep configuration register 0	0x0030	R/W
UART_SLEEP_CONF1_REG	UART sleep configuration register 1	0x0034	R/W
UART_SLEEP_CONF2_REG	UART sleep configuration register 2	0x0038	R/W
UART_SWFC_CONF0_SYNC_REG	Software flow control character configuration	0x003C	varies
UART_SWFC_CONF1_REG	Software flow control character configuration	0x0040	R/W
UART_TXBRK_CONF_SYNC_REG	TX break character configuration	0x0044	R/W
UART_IDLE_CONF_SYNC_REG	Frame end idle time configuration	0x0048	R/W
UART_RS485_CONF_SYNC_REG	RS485 mode configuration	0x004C	R/W
UART_CLK_CONF_REG	UART core clock configuration	0x0088	R/W
UART_REG_UPDATE_REG	UART register configuration update	0x0098	R/W/SC
UART_ID_REG	UART ID register	0x009C	R/W
Status Register			
UART_STATUS_REG	UART status register	0x001C	RO
UART_MEM_TX_STATUS_REG	TX FIFO write and read offset address	0x0068	RO
UART_MEM_RX_STATUS_REG	Rx FIFO write and read offset address	0x006C	RO
UART_FSM_STATUS_REG	UART transmit and receive status	0x0070	RO
UART_AFIFO_STATUS_REG	UART asynchronous FIFO status	0x0090	RO
AT Escape Sequence Selection Configuration			
UART_AT_CMD_PRECNT_SYNC_REG	Pre-sequence timing configuration	0x0050	R/W
UART_AT_CMD_POSTCNT_SYNC_REG	Post-sequence timing configuration	0x0054	R/W
UART_AT_CMD_GAPTOOUT_SYNC_REG	Timeout configuration	0x0058	R/W
UART_AT_CMD_CHAR_SYNC_REG	AT escape sequence detection configuration	0x005C	R/W

Name	Description	Address	Access
Autobaud Register			
UART_POSPULSE_REG	Autobaud high pulse register	0x0074	RO
UART_NEGPULSE_REG	Autobaud low pulse register	0x0078	RO
UART_LOWPULSE_REG	Autobaud minimum low pulse duration register	0x007C	RO
UART_HIGHPULSE_REG	Autobaud minimum high pulse duration register	0x0080	RO
UART_RXD_CNT_REG	Autobaud edge change count register	0x0084	RO
Version Register			
UART_DATE_REG	UART version control register	0x008C	R/W

26.6.2 LP UART Register Summary

The addresses in this section are relative to LP UART base address provided in Table 5-2 in Chapter 5 *System and Memory*.

The abbreviations given in Column **Access** are explained in Section *Access Types for Registers*.

Name	Description	Address	Access
FIFO Configuration			
LP_UART_FIFO_REG	FIFO data register	0x0000	RO
LP_UART_TOUT_CONF_SYNC_REG	LP UART threshold and allocation configuration	0x0064	R/W
LP UART Interrupt Register			
LP_UART_INT_RAW_REG	Raw interrupt status	0x0004	R/WTC/SS
LP_UART_INT_ST_REG	Masked interrupt status	0x0008	RO
LP_UART_INT_ENA_REG	Interrupt enable bits	0x000C	R/W
LP_UART_INT_CLR_REG	Interrupt clear bits	0x0010	WT
Configuration Register			
LP_UART_CLKDIV_SYNC_REG	Clock divider configuration	0x0014	R/W
LP_UART_RX_FILT_REG	RX filter configuration	0x0018	R/W
LP_UART_CONF0_SYNC_REG	Configuration register 0	0x0020	R/W
LP_UART_CONF1_REG	Configuration register 1	0x0024	R/W
LP_UART_HWFC_CONF_SYNC_REG	Hardware flow control configuration	0x002C	R/W
LP_UART_SLEEP_CONF0_REG	LP UART sleep configuration register 0	0x0030	R/W
LP_UART_SLEEP_CONF1_REG	LP UART sleep configuration register 1	0x0034	R/W
LP_UART_SLEEP_CONF2_REG	LP UART sleep configuration register 2	0x0038	R/W
LP_UART_SWFC_CONF0_SYNC_REG	Software flow control character configuration	0x003C	varies
LP_UART_SWFC_CONF1_REG	Software flow control character configuration	0x0040	R/W
LP_UART_TXBRK_CONF_SYNC_REG	TX break character configuration	0x0044	R/W
LP_UART_IDLE_CONF_SYNC_REG	Frame end idle time configuration	0x0048	R/W
LP_UART_DELAY_CONF_SYNC_REG	Delay bit configuration	0x004C	R/W
LP_UART_CLK_CONF_REG	LP UART core clock configuration	0x0088	R/W
LP_UART_REG_UPDATE_REG	LP UART register configuration update register	0x0098	R/W/SC
LP_UART_ID_REG	LP UART ID register	0x009C	R/W
Status Register			
LP_UART_STATUS_REG	LP UART status register	0x001C	RO
LP_UART_MEM_TX_STATUS_REG	TX FIFO write and read offset address	0x0068	RO

Name	Description	Address	Access
LP_UART_MEM_RX_STATUS_REG	RX FIFO write and read offset address	0x006C	RO
LP_UART_FSM_STATUS_REG	LP UART transmit and receive status	0x0070	RO
LP_UART_AFIFO_STATUS_REG	LP UART asynchronous FIFO Status	0x0090	RO
AT Escape Sequence Selection Configuration			
LP_UART_AT_CMD_PRECNT_SYNC_REG	Pre-sequence timing configuration	0x0050	R/W
LP_UART_AT_CMD_POSTCNT_SYNC_REG	Post-sequence timing configuration	0x0054	R/W
LP_UART_AT_CMD_GAPTOOUT_SYNC_REG	Timeout configuration	0x0058	R/W
LP_UART_AT_CMD_CHAR_SYNC_REG	AT escape sequence detection configuration	0x005C	R/W
Version Register			
LP_UART_DATE_REG	LP UART version register	0x008C	R/W

26.6.3 UHCI Register Summary

The addresses in this section are relative to UHCI base address provided in Table 5-2 in Chapter 5 *System and Memory*.

The abbreviations given in Column **Access** are explained in Section *Access Types for Registers*.

Name	Description	Address	Access
Configuration Register			
UHCI_CONF0_REG	UHCI configuration register	0x0000	R/W
UHCI_CONF1_REG	UHCI configuration register	0x0014	varies
UHCI_ESCAPE_CONF_REG	Escape character configuration	0x0020	R/W
UHCI_HUNG_CONF_REG	Timeout configuration	0x0024	R/W
UHCI_ACK_NUM_REG	UHCI ACK number configuration	0x0028	varies
UHCI_QUICK_SENT_REG	UHCI quick send configuration register	0x0030	varies
UHCI_REG_Q0_WORD0_REG	Q0 WORD0 quick send register	0x0034	R/W
UHCI_REG_Q0_WORD1_REG	Q0 WORD1 quick send register	0x0038	R/W
UHCI_REG_Q1_WORD0_REG	Q1 WORD0 quick send register	0x003C	R/W
UHCI_REG_Q1_WORD1_REG	Q1 WORD1 quick send register	0x0040	R/W
UHCI_REG_Q2_WORD0_REG	Q2 WORD0 quick send register	0x0044	R/W
UHCI_REG_Q2_WORD1_REG	Q2 WORD1 quick send register	0x0048	R/W
UHCI_REG_Q3_WORD0_REG	Q3 WORD0 quick send register	0x004C	R/W
UHCI_REG_Q3_WORD1_REG	Q3 WORD1 quick send register	0x0050	R/W
UHCI_REG_Q4_WORD0_REG	Q4 WORD0 quick send register	0x0054	R/W
UHCI_REG_Q4_WORD1_REG	Q4 WORD1 quick send register	0x0058	R/W
UHCI_REG_Q5_WORD0_REG	Q5 WORD0 quick send register	0x005C	R/W
UHCI_REG_Q5_WORD1_REG	Q5 WORD1 quick send register	0x0060	R/W
UHCI_REG_Q6_WORD0_REG	Q6 WORD0 quick send register	0x0064	R/W
UHCI_REG_Q6_WORD1_REG	Q6 WORD1 quick register	0x0068	R/W
UHCI_ESC_CONF0_REG	Escape sequence configuration register 0	0x006C	R/W
UHCI_ESC_CONF1_REG	Escape sequence configuration register 1	0x0070	R/W
UHCI_ESC_CONF2_REG	Escape sequence configuration register 2	0x0074	R/W
UHCI_ESC_CONF3_REG	Escape sequence configuration register 3	0x0078	R/W
UHCI_PKT_THRES_REG	Configuration register for packet length	0x007C	R/W

Name	Description	Address	Access
UHCI Interrupt Register			
UHCI_INT_RAW_REG	Raw interrupt status	0x0004	varies
UHCI_INT_ST_REG	Masked interrupt status	0x0008	RO
UHCI_INT_ENA_REG	Interrupt enable bits	0x000C	R/W
UHCI_INT_CLR_REG	Interrupt clear bits	0x0010	WT
UHCI Status Register			
UHCI_STATE0_REG	UHCI receive status	0x0018	RO
UHCI_STATE1_REG	UHCI transmit status	0x001C	RO
UHCI_RX_HEAD_REG	UHCI packet header register	0x002C	RO
Version Register			
UHCI_DATE_REG	UHCI version control register	0x0080	R/W

26.7 Registers

26.7.1 UART Registers

The addresses in this section are relative to UART Controller base address provided in Table 5-2 in Chapter 5 *System and Memory*.

Register 26.1. UART_FIFO_REG (0x0000)

31	(reserved)	8	7	0	UART_RXFIFO_RD_BYTE	
0 0				0		Reset

UART_RXFIFO_RD_BYTE Represents the data UART n read from FIFO.
Measurement unit: byte. (RO)

Register 26.2. UART_TOUT_CONF_SYNC_REG (0x0064)

31	(reserved)	12	11	2	1	0	UART_RX_TOUT_THRHD	(reserved)	UART_RX_TOUT_EN	
0 0				0xa		0		0		Reset

UART_RX_TOUT_EN Configures whether or not to enable UART receiver's timeout function.
0: Disable
1: Enable
(R/W)

UART_RX_TOUT_THRHD Configures the amount of time that the bus can remain idle before timeout.
Measurement unit: bit time (the time to transmit 1 bit). (R/W)

Register 26.3. UART_INT_RAW_REG (0x0004)

31	(reserved)																			20	19	18	17	16	15	14	13	12	11	10	9	8	7	6	5	4	3	2	1	0	Reset
0	0	0	0	0	0	0	0	0	0	0	0	0	0	0	0	0	0	0	0	0	0	0	0	0	0	0	0	0	0	0	0	1	0								

UART_RXFIFO_FULL_INT_RAW The raw interrupt status of UART_RXFIFO_FULL_INT. (R/WTC/SS)

UART_TXFIFO_EMPTY_INT_RAW The raw interrupt status of UART_TXFIFO_EMPTY_INT. (R/WTC/SS)

UART_PARITY_ERR_INT_RAW The raw interrupt status of UART_PARITY_ERR_INT. (R/WTC/SS)

UART_FRM_ERR_INT_RAW The raw interrupt status of UART_FRM_ERR_INT. (R/WTC/SS)

UART_RXFIFO_OVF_INT_RAW The raw interrupt status of UART_RXFIFO_OVF_INT. (R/WTC/SS)

UART_DSR_CHG_INT_RAW The raw interrupt status of UART_DSR_CHG_INT. (R/WTC/SS)

UART_CTS_CHG_INT_RAW The raw interrupt status of UART_CTS_CHG_INT. (R/WTC/SS)

UART_BRK_DET_INT_RAW The raw interrupt status of UART_BRK_DET_INT. (R/WTC/SS)

UART_RXFIFO_TOUT_INT_RAW The raw interrupt status of UART_RXFIFO_TOUT_INT. (R/WTC/SS)

UART_SW_XON_INT_RAW The raw interrupt status of UART_SW_XON_INT. (R/WTC/SS)

UART_SW_XOFF_INT_RAW UART_SW_XOFF_INT. (R/WTC/SS)

UART_GLITCH_DET_INT_RAW The raw interrupt status of UART_GLITCH_DET_INT. (R/WTC/SS)

UART_TX_BRK_DONE_INT_RAW The raw interrupt status of UART_TX_BRK_DONE_INT. (R/WTC/SS)

UART_TX_BRK_IDLE_DONE_INT_RAW The raw interrupt status of UART_TX_BRK_IDLE_DONE_INT. (R/WTC/SS)

UART_TX_DONE_INT_RAW The raw interrupt status of UART_TX_DONE_INT. (R/WTC/SS)

UART_RS485_PARITY_ERR_INT_RAW The raw interrupt status of UART_RS485_PARITY_ERR_INT. (R/WTC/SS)

UART_RS485_FRM_ERR_INT_RAW The raw interrupt status of UART_RS485_FRM_ERR_INT. (R/WTC/SS)

Continued on the next page...

Register 26.3. UART_INT_RAW_REG (0x0004)

Continued from the previous page...

UART_RS485_CLASH_INT_RAW The raw interrupt status of UART_RS485_CLASH_INT.
(R/WTC/SS)

UART_AT_CMD_CHAR_DET_INT_RAW The raw interrupt status of
UART_AT_CMD_CHAR_DET_INT. (R/WTC/SS)

UART_WAKEUP_INT_RAW The raw interrupt status of UART_WAKEUP_INT. (R/WTC/SS)

Register 26.4. UART_INT_ST_REG (0x0008)

(reserved)												UART_WAKEUP_INT_ST UART_AT_CMD_CHAR_DET_INT_ST UART_RS485_CLASH_INT_ST UART_RS485_FRM_ERR_INT_ST UART_RS485_PARITY_ERR_INT_ST UART_TX_DONE_INT_ST UART_TX_BRK_IDLE_DONE_INT_ST UART_GLITCH_DET_INT_ST UART_SW_XOFF_INT_ST UART_SW_XON_INT_ST UART_RXFIFO_TOUT_INT_ST UART_BRK_DET_INT_ST UART_CTS_CHG_INT_ST UART_DSR_CHG_INT_ST UART_RXFIFO_OVF_INT_ST UART_FRM_ERR_INT_ST UART_PARITY_ERR_INT_ST UART_TXFIFO_EMPTY_INT_ST UART_RXFIFO_FULL_INT_ST																													
31																				20	19	18	17	16	15	14	13	12	11	10	9	8	7	6	5	4	3	2	1	0	Reset
0 0																																									

UART_RXFIFO_FULL_INT_ST The masked interrupt status of UART_RXFIFO_FULL_INT. (RO)

UART_TXFIFO_EMPTY_INT_ST The masked interrupt status of UART_TXFIFO_EMPTY_INT. (RO)

UART_PARITY_ERR_INT_ST The masked interrupt status of UART_PARITY_ERR_INT. (RO)

UART_FRM_ERR_INT_ST The masked interrupt status of UART_FRM_ERR_INT. (RO)

UART_RXFIFO_OVF_INT_ST The masked interrupt status of UART_RXFIFO_OVF_INT. (RO)

UART_DSR_CHG_INT_ST The masked interrupt status of UART_DSR_CHG_INT. (RO)

UART_CTS_CHG_INT_ST The masked interrupt status of UART_CTS_CHG_INT. (RO)

UART_BRK_DET_INT_ST The masked interrupt status of UART_BRK_DET_INT. (RO)

UART_RXFIFO_TOUT_INT_ST The masked interrupt status of UART_RXFIFO_TOUT_INT. (RO)

UART_SW_XON_INT_ST The masked interrupt status of UART_SW_XON_INT. (RO)

UART_SW_XOFF_INT_ST The masked interrupt status of UART_SW_XOFF_INT. (RO)

UART_GLITCH_DET_INT_ST The masked interrupt status of UART_GLITCH_DET_INT. (RO)

UART_TX_BRK_DONE_INT_ST The masked interrupt status of UART_TX_BRK_DONE_INT. (RO)

UART_TX_BRK_IDLE_DONE_INT_ST The masked interrupt status of UART_TX_BRK_IDLE_DONE_INT. (RO)

UART_TX_DONE_INT_ST The masked interrupt status of UART_TX_DONE_INT. (RO)

UART_RS485_PARITY_ERR_INT_ST The masked interrupt status of UART_RS485_PARITY_ERR_INT. (RO)

UART_RS485_FRM_ERR_INT_ST The masked interrupt status of UART_RS485_FRM_ERR_INT. (RO)

UART_RS485_CLASH_INT_ST The masked interrupt status of UART_RS485_CLASH_INT. (RO)

UART_AT_CMD_CHAR_DET_INT_ST The masked interrupt status of UART_AT_CMD_CHAR_DET_INT. (RO)

UART_WAKEUP_INT_ST The masked interrupt status of UART_WAKEUP_INT. (RO)

Register 26.5. UART_INT_ENA_REG (0x000C)

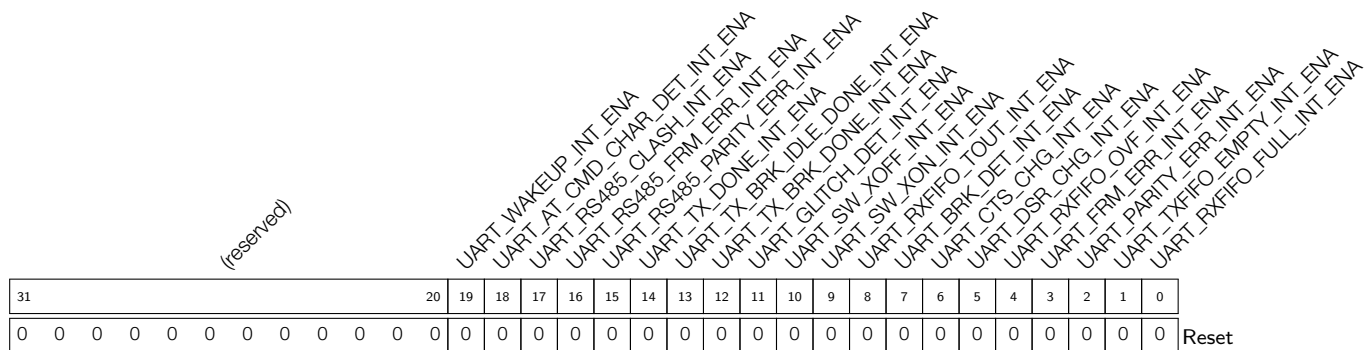

- UART_RXFIFO_FULL_INT_ENA** Write 1 to enable UART_RXFIFO_FULL_INT. (R/W)
- UART_TXFIFO_EMPTY_INT_ENA** Write 1 to enable UART_TXFIFO_EMPTY_INT. (R/W)
- UART_PARITY_ERR_INT_ENA** Write 1 to enable UART_PARITY_ERR_INT. (R/W)
- UART_FRM_ERR_INT_ENA** Write 1 to enable UART_FRM_ERR_INT. (R/W)
- UART_RXFIFO_OVF_INT_ENA** Write 1 to enable UART_RXFIFO_OVF_INT. (R/W)
- UART_DSR_CHG_INT_ENA** Write 1 to enable UART_DSR_CHG_INT. (R/W)
- UART_CTS_CHG_INT_ENA** Write 1 to enable UART_CTS_CHG_INT. (R/W)
- UART_BRK_DET_INT_ENA** Write 1 to enable UART_BRK_DET_INT. (R/W)
- UART_RXFIFO_TOUT_INT_ENA** Write 1 to enable UART_RXFIFO_TOUT_INT. (R/W)
- UART_SW_XON_INT_ENA** Write 1 to enable UART_SW_XON_INT.(R/W)
- UART_SW_XOFF_INT_ENA** Write 1 to enable UART_SW_XOFF_INT. (R/W)
- UART_GLITCH_DET_INT_ENA** Write 1 to enable UART_GLITCH_DET_INT. (R/W)
- UART_TX_BRK_DONE_INT_ENA** Write 1 to enable UART_TX_BRK_DONE_INT. (R/W)
- UART_TX_BRK_IDLE_DONE_INT_ENA** Write 1 to enable UART_TX_BRK_IDLE_DONE_INT. (R/W)
- UART_TX_DONE_INT_ENA** Write 1 to enable UART_TX_DONE_INT. (R/W)
- UART_RS485_PARITY_ERR_INT_ENA** Write 1 to enable UART_RS485_PARITY_ERR_INT. (R/W)
- UART_RS485_FRM_ERR_INT_ENA** Write 1 to enable UART_RS485_FRM_ERR_INT. (R/W)
- UART_RS485_CLASH_INT_ENA** Write 1 to enable UART_RS485_CLASH_INT. (R/W)
- UART_AT_CMD_CHAR_DET_INT_ENA** Write 1 to enable UART_AT_CMD_CHAR_DET_INT. (R/W)
- UART_WAKEUP_INT_ENA** Write 1 to enable UART_WAKEUP_INT. (R/W)

Register 26.6. UART_INT_CLR_REG (0x0010)

31	20	19	18	17	16	15	14	13	12	11	10	9	8	7	6	5	4	3	2	1	0	Reset
0	0	0	0	0	0	0	0	0	0	0	0	0	0	0	0	0	0	0	0	0	0	

(reserved)

UART_WAKEUP_INT_CLR
 UART_AT_CMD_CHAR_DET_INT_CLR
 UART_RS485_CLASH_INT_CLR
 UART_RS485_FRM_ERR_INT_CLR
 UART_RS485_PARITY_ERR_INT_CLR
 UART_TX_DONE_INT_CLR
 UART_TX_BRK_IDLE_DONE_INT_CLR
 UART_GLITCH_DET_INT_CLR
 UART_SW_XOFF_INT_CLR
 UART_SW_XON_INT_CLR
 UART_RXFIFO_TOUT_CLR
 UART_BRK_DET_INT_CLR
 UART_CTS_CHG_INT_CLR
 UART_DSR_CHG_INT_CLR
 UART_RXFIFO_OVF_INT_CLR
 UART_FRM_ERR_INT_CLR
 UART_PARITY_ERR_INT_CLR
 UART_TXFIFO_EMPTY_INT_CLR
 UART_RXFIFO_FULL_INT_CLR

- UART_RXFIFO_FULL_INT_CLR** Write 1 to clear UART_RXFIFO_FULL_INT. (WT)
- UART_TXFIFO_EMPTY_INT_CLR** Write 1 to clear UART_TXFIFO_EMPTY_INT. (WT)
- UART_PARITY_ERR_INT_CLR** Write 1 to clear UART_PARITY_ERR_INT. (WT)
- UART_FRM_ERR_INT_CLR** Write 1 to clear UART_FRM_ERR_INT. (WT)
- UART_RXFIFO_OVF_INT_CLR** Write 1 to clear UART_RXFIFO_OVF_INT. (WT)
- UART_DSR_CHG_INT_CLR** Write 1 to clear UART_DSR_CHG_INT. (WT)
- UART_CTS_CHG_INT_CLR** Write 1 to clear UART_CTS_CHG_INT. (WT)
- UART_BRK_DET_INT_CLR** Write 1 to clear UART_BRK_DET_INT. (WT)
- UART_RXFIFO_TOUT_INT_CLR** Write 1 to clear UART_RXFIFO_TOUT_INT. (WT)
- UART_SW_XON_INT_CLR** Write 1 to clear UART_SW_XON_INT. (WT)
- UART_SW_XOFF_INT_CLR** Write 1 to clear UART_SW_XOFF_INT. (WT)
- UART_GLITCH_DET_INT_CLR** Write 1 to clear UART_GLITCH_DET_INT. (WT)
- UART_TX_BRK_DONE_INT_CLR** Write 1 to clear UART_TX_BRK_DONE_INT. (WT)
- UART_TX_BRK_IDLE_DONE_INT_CLR** Write 1 to clear UART_TX_BRK_IDLE_DONE_INT. (WT)
- UART_TX_DONE_INT_CLR** Write 1 to clear UART_TX_DONE_INT. (WT)
- UART_RS485_PARITY_ERR_INT_CLR** Write 1 to clear UART_RS485_PARITY_ERR_INT. (WT)
- UART_RS485_FRM_ERR_INT_CLR** Write 1 to clear UART_RS485_FRM_ERR_INT. (WT)
- UART_RS485_CLASH_INT_CLR** Write 1 to clear UART_RS485_CLASH_INT. (WT)
- UART_AT_CMD_CHAR_DET_INT_CLR** Write 1 to clear UART_AT_CMD_CHAR_DET_INT. (WT)
- UART_WAKEUP_INT_CLR** Write 1 to clear UART_WAKEUP_INT. (WT)

Register 26.7. UART_CLKDIV_SYNC_REG (0x0014)

(reserved)								UART_CLKDIV_FRAG				(reserved)				UART_CLKDIV				
31						24	23	20	19				12	11				0		
0	0	0	0	0	0	0	0	0	0	0	0	0	0	0	0	0	0	0	0x2b6	Reset

UART_CLKDIV Configures the integral part of the divisor for baud rate generation. (R/W)

UART_CLKDIV_FRAG Configures the fractional part of the divisor for baud rate generation. (R/W)

Register 26.8. UART_RX_FILT_REG (0x0018)

(reserved)																UART_GLITCH_FILT_EN		UART_GLITCH_FILT			
31																9	8	7	0		
0	0	0	0	0	0	0	0	0	0	0	0	0	0	0	0	0	0	0	0	0x8	Reset

UART_GLITCH_FILT Configures the width of a pulse to be filtered.

Measurement unit: UART Core's clock cycle.

Pulses whose width is lower than this value will be ignored. (R/W)

UART_GLITCH_FILT_EN Configures whether or not to enable RX signal filter.

0: Disable

1: Enable(R/W)

Register 26.9. UART_CONF0_SYNC_REG (0x0020)

(reserved)								UART_TXFIFO_RST	UART_RXFIFO_RST	UART_SW_RST	UART_MEM_CLK_EN	UART_AUTOBAUD_EN	UART_ERR_WDR_MASK	UART_DIS_RX_DAT_INV	UART_TXD_INV	UART_RXD_INV	UART_IRDA_EN	UART_TX_FLOW_EN	UART_LOOPBACK	UART_IRDA_RX_INV	UART_IRDA_TX_INV	UART_IRDA_WCTL	UART_IRDA_TX_EN	UART_IRDA_DPLX	UART_TXD_BRK	UART_STOP_BIT_NUM	UART_BIT_NUM	UART_PARITY_EN	UART_PARITY
31	24	23	22	21	20	19	18	17	16	15	14	13	12	11	10	9	8	7	6	5	4	3	2	1	0				
0	0	0	0	0	0	0	0	0	0	0	0	0	0	0	0	0	0	0	0	0	0	0	1	3	0	0		Reset	

UART_PARITY Configures the parity check mode.

0: Even parity

1: Odd parity

(R/W)

UART_PARITY_EN Configures whether or not to enable UART parity check.

0: Disable

1: Enable

(R/W)

UART_BIT_NUM Configures the number of data bits.

0: 5 bits

1: 6 bits

2: 7 bits

3: 8 bits

(R/W)

UART_STOP_BIT_NUM Configures the number of stop bits.

0: Invalid. No effect

1: 1 bit

2: 1.5 bits

3: 2 bits

(R/W)

UART_TXD_BRK Configures whether or not to send NULL characters when finishing data transmission.

0: Not send

1: Send

(R/W)

UART_IRDA_DPLX Configures whether or not to enable IrDA loopback test.

0: Disable

1: Enable

(R/W)

UART_IRDA_TX_EN Configures whether or not to enable the IrDA transmitter.

0: Disable

1: Enable

(R/W)

Continued on the next page...

Register 26.9. UART_CONF0_SYNC_REG (0x0020)

Continued from the previous page...

UART_IRDA_WCTL Configures the 11th bit of the IrDA transmitter.

0: This bit is 0.

1: This bit is the same as the 10th bit.

(R/W)

UART_IRDA_TX_INV Configures whether or not to invert the level of the IrDA transmitter.

0: Not invert

1: Invert

(R/W)

UART_IRDA_RX_INV Configures whether or not to invert the level of the IrDA receiver.

0: Not invert

1: Invert

(R/W)

UART_LOOPBACK Configures whether or not to enable UART loopback test.

0: Disable

1: Enable

(R/W)

UART_TX_FLOW_EN Configures whether or not to enable flow control for the transmitter.

0: Disable

1: Enable

(R/W)

UART_IRDA_EN Configures whether or not to enable IrDA protocol.

0: Disable

1: Enable

(R/W)

UART_RXD_INV Configures whether or not to invert the level of UART RXD signal.

0: Not invert

1: Invert

(R/W)

UART_TXD_INV Configures whether or not to invert the level of UART TXD signal.

0: Not invert

1: Invert

(R/W)

UART_DIS_RX_DAT_OVF Configures whether or not to disable data overflow detection for the UART receiver.

0: Enable

1: Disable

(R/W)

Continued on the next page...

Register 26.9. UART_CONF0_SYNC_REG (0x0020)

Continued from the previous page...

UART_ERR_WR_MASK Configures whether or not to store the received data with errors into FIFO.

- 0: Store
 - 1: Not store
- (R/W)

UART_AUTOBAUD_EN Configures whether or not to enable baud rate detection.

- 0: Disable
 - 1: Enable
- (R/W)

UART_MEM_CLK_EN Configures whether or not to enable clock gating for UART memory.

- 0: Disable
 - 1: Enable
- (R/W)

UART_SW_RTS Configures the RTS signal used in software flow control.

- 0: The UART transmitter is allowed to send data.
 - 1: The UART transmitted is not allowed to send data.
- (R/W)

UART_RXFIFO_RST Configures whether or not to reset the UART RX FIFO.

- 0: Not reset
 - 1: Reset
- (R/W)

UART_TXFIFO_RST Configures whether or not to reset the UART TX FIFO.

- 0: Not reset
 - 1: Reset
- (R/W)

Register 26.10. UART_CONF1_REG (0x0024)

(reserved)										UART_CLK_EN UART_SW_DTR UART_DTR_INV UART_RTS_INV UART_DSR_INV UART_CTS_INV							UART_TXFIFO_EMPTY_THRHD		UART_RXFIFO_FULL_THRHD						
31											22	21	20	19	18	17	16	15			8	7			0
0 0 0 0 0 0 0 0 0 0										0 0 0 0 0 0 0							0x60		0x60		Reset				

UART_RXFIFO_FULL_THRHD Configures the threshold for RX FIFO being full.

Measurement unit: byte. (R/W)

UART_TXFIFO_EMPTY_THRHD Configures the threshold for TX FIFO being empty.

Measurement unit: byte. (R/W)

UART_CTS_INV Configures whether or not to invert the level of UART CTS signal.

0: Not invert

1: Invert

(R/W)

UART_DSR_INV Configures whether or not to invert the level of UART DSR signal.

0: Not invert

1: Invert

(R/W)

UART_RTS_INV Configures whether or not to invert the level of UART RTS signal.

0: Not invert

1: Invert

(R/W)

UART_DTR_INV Configures whether or not to invert the level of UART DTR signal.

0: Not invert

1: Invert

(R/W)

UART_SW_DTR Configures the DTR signal used in software flow control.

0: Data to be transmitted is not ready.

1: Data to be transmitted is ready.

(R/W)

UART_CLK_EN Configures clock gating.

0: Support clock only when the application writes registers.

1: Always force the clock on for registers.

(R/W)

Register 26.11. UART_HWFC_CONF_SYNC_REG (0x002C)

(reserved)																UART_RX_FLOW_EN		UART_RX_FLOW_THRHD		
31															9	8	7	0		
0																0		0x0		Reset

UART_RX_FLOW_THRHD Configures the maximum number of data bytes that can be received during hardware flow control.

Measurement unit: byte. (R/W)

UART_RX_FLOW_EN Configures whether or not to enable the UART receiver.

0: Disable

1: Enable

(R/W)

Register 26.12. UART_SLEEP_CONF0_REG (0x0030)

UART_WK_CHAR4								UART_WK_CHAR3								UART_WK_CHAR2								UART_WK_CHAR1								
31								24	23							16	15			8	7			0								
0x0								0x0								0x0								0x0								Reset

UART_WK_CHAR1 Configures wakeup character 1. (R/W)

UART_WK_CHAR2 Configures wakeup character 2. (R/W)

UART_WK_CHAR3 Configures wakeup character 3. (R/W)

UART_WK_CHAR4 Configures wakeup character 4. (R/W)

Register 26.13. UART_SLEEP_CONF1_REG (0x0034)

(reserved)																UART_WK_CHAR0		
31															8	7	0	
0																0x0		Reset

UART_WK_CHAR0 Configures wakeup character 0. (R/W)

Register 26.14. UART_SLEEP_CONF2_REG (0x0038)

(reserved)				UART_WK_MODE_SEL		UART_WK_CHAR_MASK		UART_WK_CHAR_NUM		UART_RX_WAKE_UP_THRHD		UART_ACTIVE_THRESHOLD		
31	28	27	26	25	21	20	18	17	10	9				
0	0	0	0	0	0x0	0x5	1		0x10				0	Reset

UART_ACTIVE_THRESHOLD Configures the number of RXD edge changes to wake up the chip in wakeup mode 0. (R/W)

UART_RX_WAKE_UP_THRHD Configures the number of received data bytes to wake up the chip in wakeup mode 1. (R/W)

UART_WK_CHAR_NUM Configures the number of wakeup characters. (R/W)

UART_WK_CHAR_MASK Configures whether or not to mask wakeup characters.

0: Not mask

1: Mask

(R/W)

UART_WK_MODE_SEL Configures which wakeup mode to select.

0: Mode 0

1: Mode 1

2: Mode 2

3: Mode 3

(R/W)

Register 26.15. UART_SWFC_CONF0_SYNC_REG (0x003C)

(reserved)										UART_SEND_XOFF										UART_SEND_XON										UART_FORCE_XOFF										UART_FORCE_XON										UART_SW_FLOW_CON_EN										UART_XON_XOFF_STILL_SEND										UART_XOFF_CHAR										UART_XON_CHAR									
31									23	22	21	20	19	18	17	16	15									8	7												0																																																		
0										0										0x13										0x11										Reset																																																	

UART_XON_CHAR Configures the XON character for flow control. (R/W)

UART_XOFF_CHAR Configures the XOFF character for flow control. (R/W)

UART_XON_XOFF_STILL_SEND Configures whether the UART transmitter can send XON or XOFF characters when it is disabled.

0: Cannot send

1: Can send

(R/W)

UART_SW_FLOW_CON_EN Configures whether or not to enable software flow control.

0: Disable

1: Enable

(R/W)

UART_XONOFF_DEL Configures whether or not to remove flow control characters from the received data.

0: Not move

1: Move

(R/W)

UART_FORCE_XON Configures whether the transmitter continues to sending data.

0: Not send

1: Send

(R/W)

UART_FORCE_XOFF Configures whether or not to stop the transmitter from sending data.

0: Not stop

1: Stop

(R/W)

UART_SEND_XON Configures whether or not to send XON characters.

0: Not send

1: Send

(R/W/SS/SC)

UART_SEND_XOFF Configures whether or not to send XOFF characters.

0: Not send

1: Send

(R/W/SS/SC)

Register 26.16. UART_SWFC_CONF1_REG (0x0040)

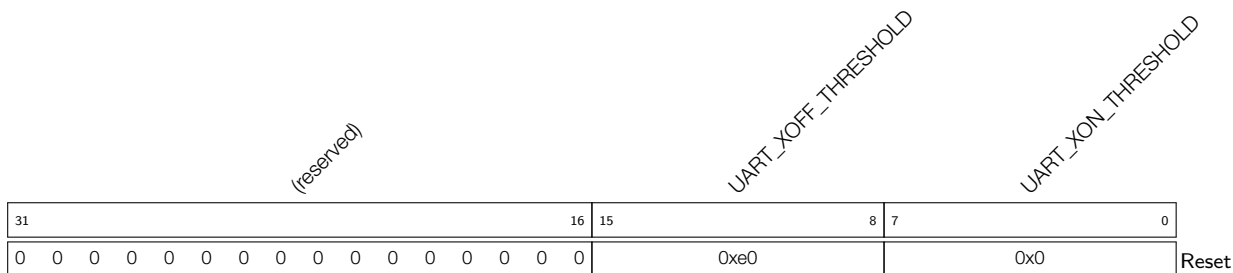

UART_XON_THRESHOLD Configures the threshold for data in RX FIFO to send XON characters in software flow control.
Measurement unit: byte. (R/W)

UART_XOFF_THRESHOLD Configures the threshold for data in RX FIFO to send XOFF characters in software flow control.
Measurement unit: byte. (R/W)

Register 26.17. UART_TXBRK_CONF_SYNC_REG (0x0044)

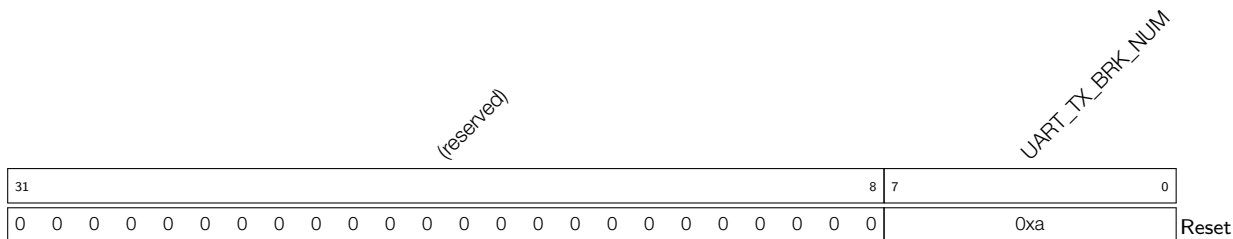

UART_TX_BRK_NUM Configures the number of NULL characters to be sent after finishing data transmission.
Valid only when UART_TXD_BRK is 1. (R/W)

Register 26.18. UART_IDLE_CONF_SYNC_REG (0x0048)

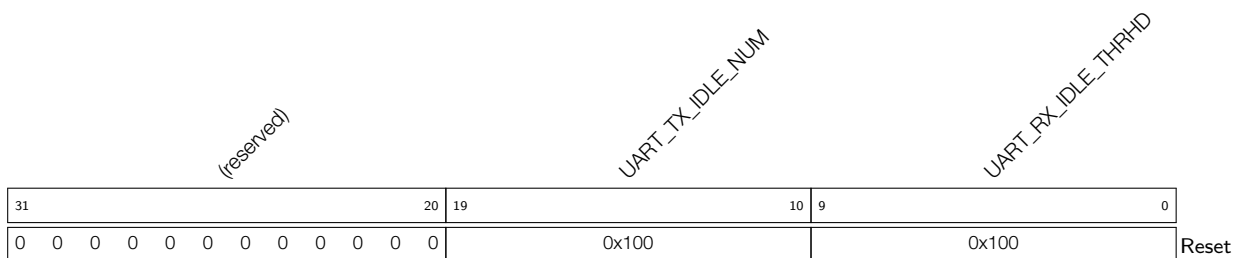

UART_RX_IDLE_THRHD Configures the threshold to generate a frame end signal when the receiver takes more time to receive one data byte data.
Measurement unit: bit time (the time to transmit 1 bit). (R/W)

UART_TX_IDLE_NUM Configures the interval between two data transfers.
Measurement unit: bit time (the time to transmit 1 bit). (R/W)

Register 26.19. UART_RS485_CONF_SYNC_REG (0x004C)

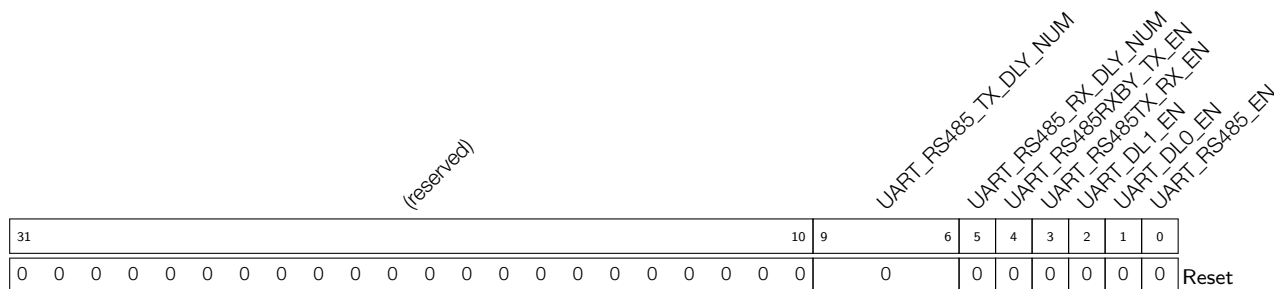

UART_RS485_EN Configures whether or not to enable RS485 mode.

- 0: Disable
 - 1: Enable
- (R/W)

UART_DLO_EN Configures whether or not to add a turnaround delay of 1 bit before the start bit.

- 0: Not add
 - 1: Add
- (R/W)

UART_DL1_EN Configures whether or not to add a turnaround delay of 1 bit after the stop bit.

- 0: Not add
 - 1: Add
- (R/W)

UART_RS485TX_RX_EN Configures whether or not to enable the receiver for data reception when the transmitter is transmitting data in RS485 mode.

- 0: Disable
 - 1: Enable
- (R/W)

UART_RS485RXBY_TX_EN Configures whether to enable the RS485 transmitter for data transmission when the RS485 receiver is busy.

- 0: Disable
 - 1: Enable
- (R/W)

UART_RS485_RX_DLY_NUM Configures the delay of internal data signals in the receiver.

Measurement unit: bit time (the time to transmit 1 bit).. (R/W)

UART_RS485_TX_DLY_NUM Configures the delay of internal data signals in the transmitter.

Measurement unit: bit time (the time to transmit 1 bit). (R/W)

Register 26.20. UART_CLK_CONF_REG (0x0088)

(reserved)				UART_RX_RST_CORE UART_TX_RST_CORE UART_RX_SCLK_EN UART_TX_SCLK_EN				(reserved)				
31	28	27	26	25	24	23					0	
0	0	0	0	0	0	1	1	0				Reset

UART_TX_SCLK_EN Configures whether or not to enable UART TX clock.

0: Disable

1: Enable

(R/W)

UART_RX_SCLK_EN Configures whether or not to enable UART RX clock.

0: Disable

1: Enable

(R/W)

UART_TX_RST_CORE Write 1 and then write 0 to reset UART TX. (R/W)

UART_RX_RST_CORE Write 1 and then write 0 to reset UART RX. (R/W)

Register 26.21. UART_STATUS_REG (0x001C)

UART_TXD UART_RTSN UART_DTRN				(reserved)				UART_TXFIFO_CNT				UART_RXD UART_CTSN UART_DSRN				(reserved)				UART_RXFIFO_CNT									
31	30	29	28					24	23					16	15	14	13	12					8	7					0
1	1	1	0	0	0	0	0	0				1	1	0	0	0	0	0	0	0	0	0	0	0				Reset	

UART_RXFIFO_CNT Represents the number of valid data bytes in RX FIFO. (RO)

UART_DSRN Represents the level of the internal UART DSR signal. (RO)

UART_CTSN Represents the level of the internal UART CTS signal. (RO)

UART_RXD Represents the level of the internal UART RXD signal. (RO)

UART_TXFIFO_CNT Represents the number of valid data bytes in TX FIFO. (RO)

UART_DTRN Represents the level of the internal UART DTR signal. (RO)

UART_RTSN Represents the level of the internal UART RTS signal. (RO)

UART_TXD Represents the level of the internal UART TXD signal. (RO)

Register 26.22. UART_MEM_TX_STATUS_REG (0x0068)

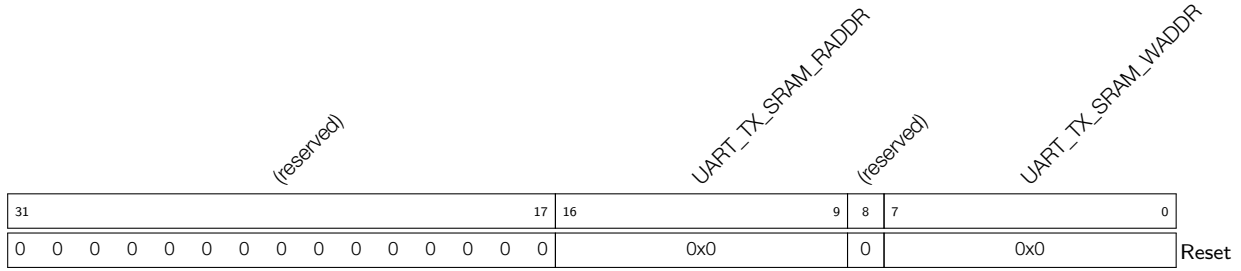

UART_TX_SRAM_WADDR Represents the offset address to write TX FIFO. (RO)

UART_TX_SRAM_RADDR Represents the offset address to read TX FIFO. (RO)

Register 26.23. UART_MEM_RX_STATUS_REG (0x006C)

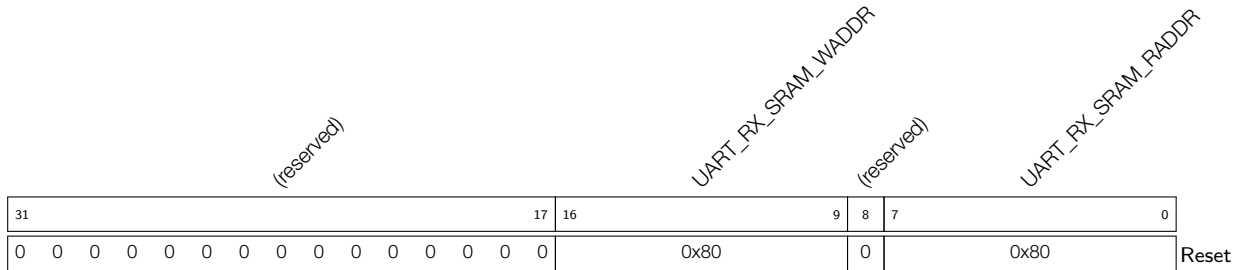

UART_RX_SRAM_RADDR Represents the offset address to read RX FIFO. (RO)

UART_RX_SRAM_WADDR Represents the offset address to write RX FIFO. (RO)

Register 26.24. UART_FSM_STATUS_REG (0x0070)

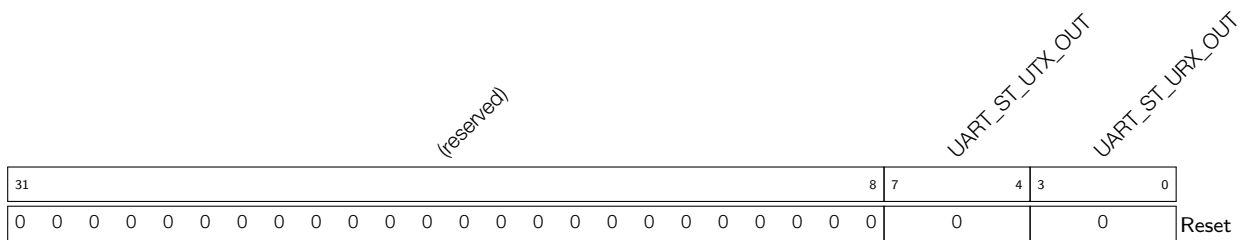

UART_ST_URX_OUT Represents the status of the receiver. (RO)

UART_ST_UTX_OUT Represents the status of the transmitter. (RO)

Register 26.25. UART_AFIFO_STATUS_REG (0x0090)

<i>(reserved)</i>																<i>UART_RX_AFIFO_EMPTY</i>				<i>UART_RX_AFIFO_FULL</i>				<i>UART_TX_AFIFO_EMPTY</i>				<i>UART_TX_AFIFO_FULL</i>																								
31																												4	3	2	1	0																				
0 0																1 0 1 0				Reset																																

UART_TX_AFIFO_FULL Represents whether or not the APB TX asynchronous FIFO is full.
 0: Not full
 1: Full
 (RO)

UART_TX_AFIFO_EMPTY Represents whether or not the APB TX asynchronous FIFO is empty.
 0: Not empty
 1: Empty
 (RO)

UART_RX_AFIFO_FULL Represents whether or not the APB RX asynchronous FIFO is full.
 0: Not full
 1: Full
 (RO)

UART_RX_AFIFO_EMPTY Represents whether or not the APB RX asynchronous FIFO is empty.
 0: Not empty
 1: Empty
 (RO)

Register 26.26. UART_AT_CMD_PRECNT_SYNC_REG (0x0050)

<i>(reserved)</i>																<i>UART_PRE_IDLE_NUM</i>																			
31																	16	15																	0
0 0 0 0 0 0 0 0 0 0 0 0 0 0 0 0 0 0																0x901																Reset			

UART_PRE_IDLE_NUM Configures the idle time before the receiver receives the first AT_CMD.
 Measurement unit: bit time (the time to transmit 1 bit). (R/W)

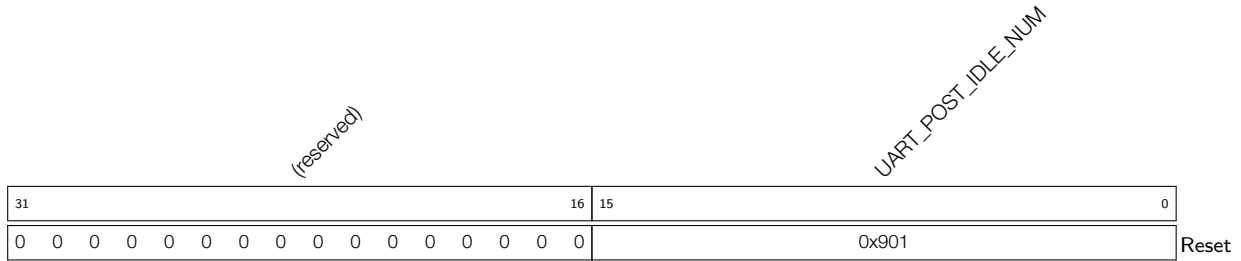
Register 26.27. UART_AT_CMD_POSTCNT_SYNC_REG (0x0054)

UART_POST_IDLE_NUM Configures the interval between the last AT_CMD and subsequent data.
Measurement unit: bit time (the time to transmit 1 bit). (R/W)

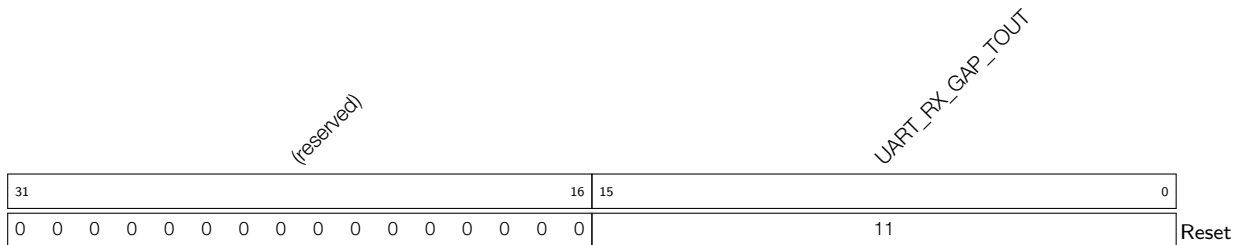
Register 26.28. UART_AT_CMD_GAPTOU_SYNC_REG (0x0058)

UART_RX_GAP_TOUT Configures the interval between two AT_CMD characters.
Measurement unit: bit time (the time to transmit 1 bit). (R/W)

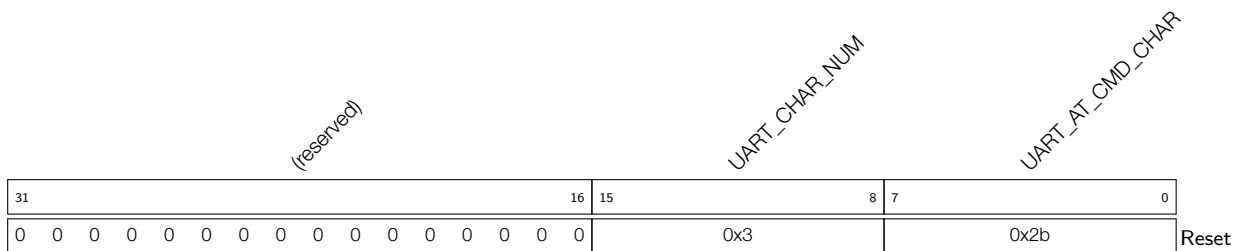
Register 26.29. UART_AT_CMD_CHAR_SYNC_REG (0x005C)

UART_AT_CMD_CHAR Configures the AT_CMD character. (R/W)

UART_CHAR_NUM Configures the number of continuous AT_CMD characters a receiver can receive.
(R/W)

Register 26.30. UART_POSPULSE_REG (0x0074)

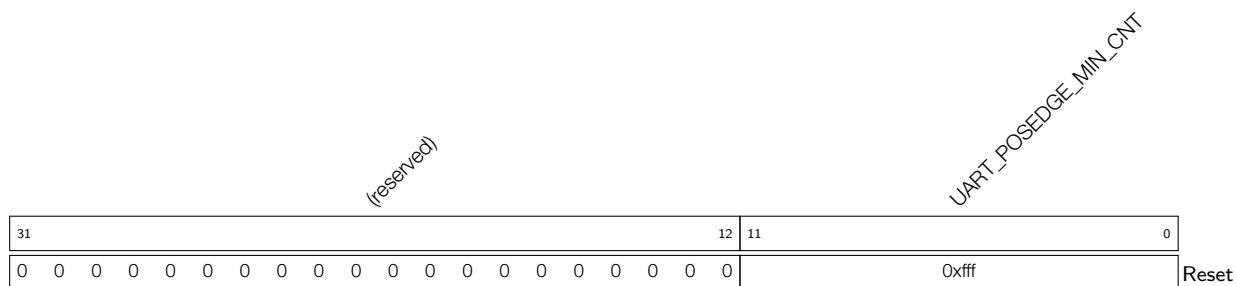

UART_POSEDGE_MIN_CNT Represents the minimal input clock counter value between two positive edges. It is used for baud rate detection. (RO)

Register 26.31. UART_NEGPULSE_REG (0x0078)

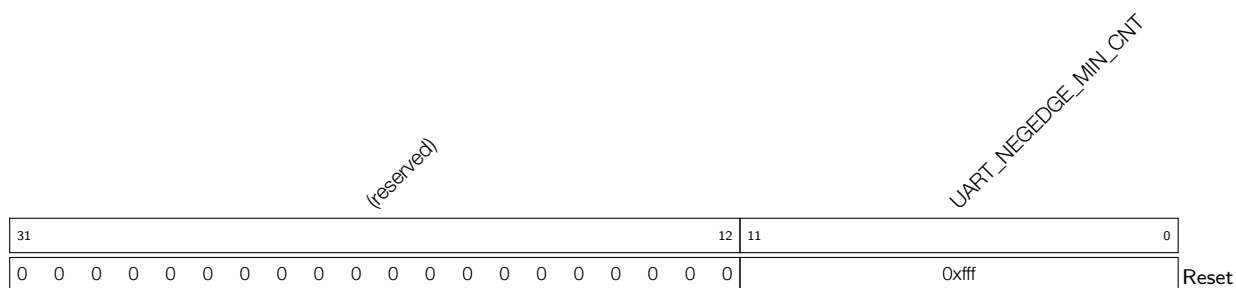

UART_NEGEDGE_MIN_CNT Represents the minimal input clock counter value between two negative edges. It is used for baud rate detection. (RO)

Register 26.32. UART_LOWPULSE_REG (0x007C)

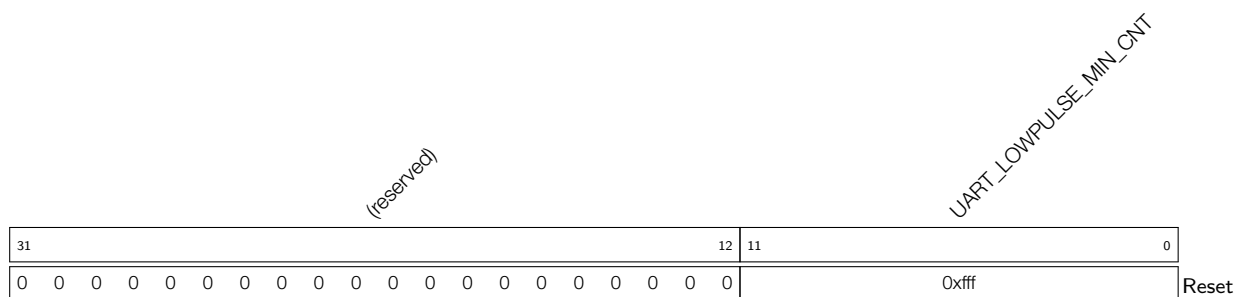

UART_LOWPULSE_MIN_CNT Represents the minimum duration time of a low-level pulse. It is used for baud rate detection.
Measurement unit: APB_CLK clock cycle. (RO)

Register 26.33. UART_HIGHPULSE_REG (0x0080)

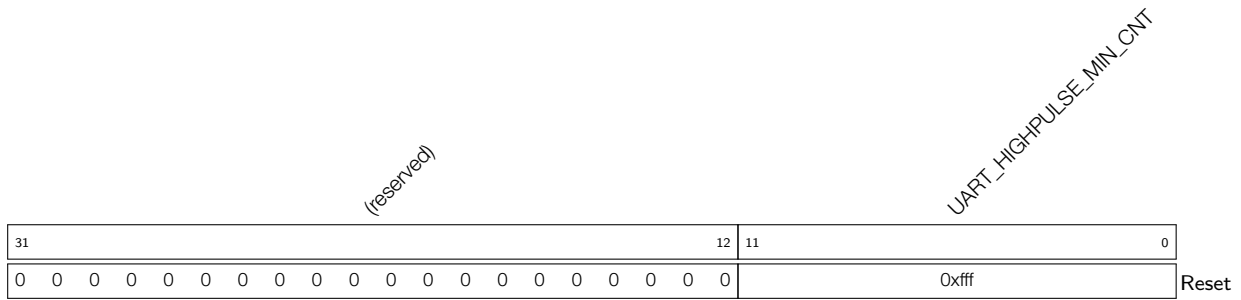

UART_HIGHPULSE_MIN_CNT Represents the maximum duration time for a high-level pulse. It is used for baud rate detection.
 Measurement unit: APB_CLK clock cycle. (RO)

Register 26.34. UART_RXD_CNT_REG (0x0084)

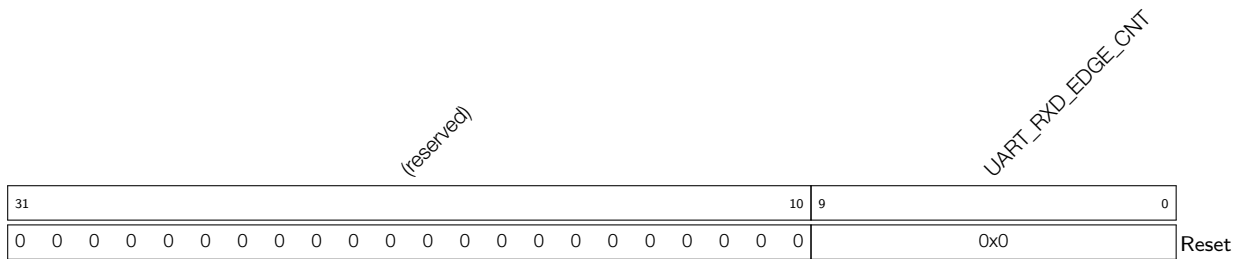

UART_RXD_EDGE_CNT Represents the number of RXD edge changes. It is used for baud rate detection. (RO)

Register 26.35. UART_DATE_REG (0x008C)

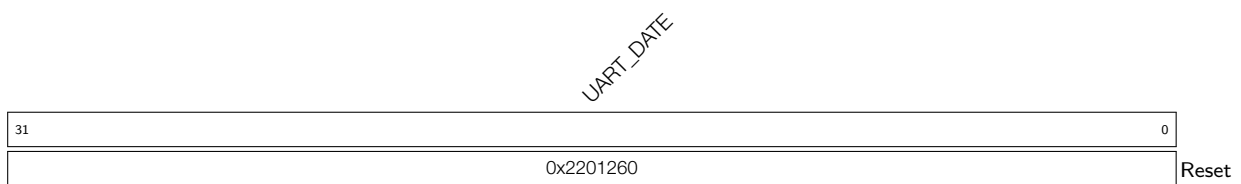

UART_DATE Version control register. (R/W)

Register 26.36. UART_REG_UPDATE_REG (0x0098)

(reserved)															UART_REG_UPDATE															
31																													1	0
0 0																												0	0	

UART_REG_UPDATE Configures whether or not to synchronize registers.

0: Not synchronize

1: Synchronize

(R/W/SC)

Register 26.37. UART_ID_REG (0x009C)

UART_ID																													
31																													0
0x000500																												0	0

UART_ID Configures the UART ID. (R/W)

26.7.2 LP UART Registers

The addresses in this section are relative to LP UART base address provided in Table 5-2 in Chapter 5 *System and Memory*.

Register 26.38. LP_UART_FIFO_REG (0x0000)

(reserved)															LP_UART_RXFIFO_RD_BYTE																
31																8	7	0													
0 0 0 0 0 0 0 0 0 0 0 0 0 0 0															0															0	0

LP_UART_RXFIFO_RD_BYTE Represents the data LP UART *n* read from FIFO.

Measurement unit: byte. (RO)

Register 26.39. LP_UART_TOUT_CONF_SYNC_REG (0x0064)

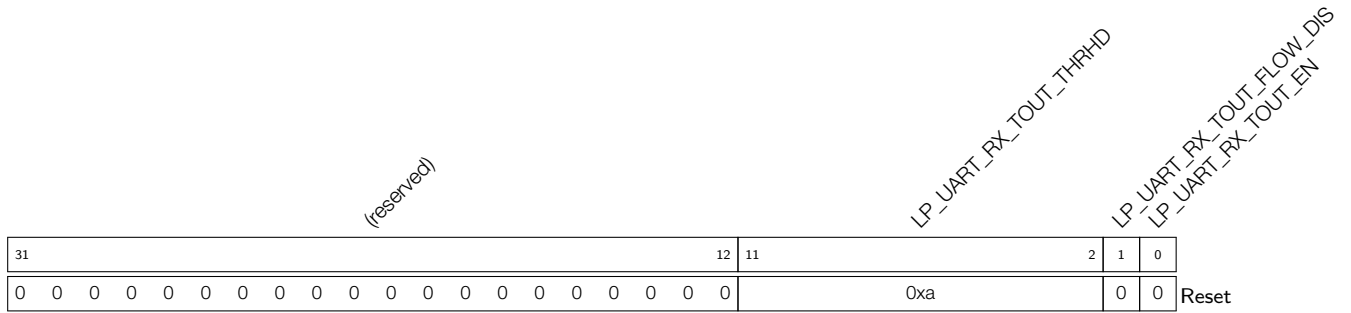

LP_UART_RX_TOUT_EN Configures whether or not to enable LP UART receiver’s timeout function.

0: Disable

1: Enable

(R/W)

LP_UART_RX_TOUT_FLOW_DIS Configures whether or not to stop the idle status counter when hardware flow control is enabled.

0: Invalid. No effect

1: Stop

(R/W)

LP_UART_RX_TOUT_THRHD Configures the amount of time that the bus can remain idle before timeout.

Measurement unit: bit time (the time to transmit 1 bit). (R/W)

Register 26.40. LP_UART_INT_RAW_REG (0x0004)

Continued from the previous page...

LP_UART_TX_DONE_INT_RAW The raw interrupt status of LP_UART_TX_DONE_INT. (R/WTC/SS)

LP_UART_AT_CMD_CHAR_DET_INT_RAW The raw interrupt status of LP_UART_AT_CMD_CHAR_DET_INT. (R/WTC/SS)

LP_UART_WAKEUP_INT_RAW The raw interrupt status of LP_UART_WAKEUP_INT. (R/WTC/SS)

Register 26.42. LP_UART_INT_ENA_REG (0x000C)

(reserved)											LP_UART_WAKEUP_INT_ENA LP_UART_AT_CMD_CHAR_DET_INT_ENA											(reserved)											LP_UART_TX_DONE_INT_ENA LP_UART_TX_BRK_IDLE_DONE_INT_ENA LP_UART_TX_BRK_DONE_INT_ENA LP_UART_GLITCH_DET_INT_ENA LP_UART_SW_XOFF_INT_ENA LP_UART_SW_XON_INT_ENA LP_UART_RXFIFO_TOUT_INT_ENA LP_UART_CTS_CHG_INT_ENA LP_UART_DSR_CHG_INT_ENA LP_UART_RXFIFO_OVF_INT_ENA LP_UART_FRM_ERR_INT_ENA LP_UART_PARITY_ERR_INT_ENA LP_UART_TXFIFO_EMPTY_INT_ENA										
31																				20	19	18	17				15	14	13	12	11	10	9	8	7	6	5	4	3	2	1	0	Reset
0 0																																											

- LP_UART_RXFIFO_FULL_INT_ENA** Write 1 to enable LP_UART_RXFIFO_FULL_INT. (R/W)
- LP_UART_TXFIFO_EMPTY_INT_ENA** Write 1 to enable LP_UART_TXFIFO_EMPTY_INT. (R/W)
- LP_UART_PARITY_ERR_INT_ENA** Write 1 to enable LP_UART_PARITY_ERR_INT. (R/W)
- LP_UART_FRM_ERR_INT_ENA** Write 1 to enable LP_UART_FRM_ERR_INT. (R/W)
- LP_UART_RXFIFO_OVF_INT_ENA** Write 1 to enable LP_UART_RXFIFO_OVF_INT. (R/W)
- LP_UART_DSR_CHG_INT_ENA** Write 1 to enable LP_UART_DSR_CHG_INT. (R/W)
- LP_UART_CTS_CHG_INT_ENA** Write 1 to enable LP_UART_CTS_CHG_INT. (R/W)
- LP_UART_BRK_DET_INT_ENA** Write 1 to enable LP_UART_BRK_DET_INT. (R/W)
- LP_UART_RXFIFO_TOUT_INT_ENA** Write 1 to enable LP_UART_RXFIFO_TOUT_INT. (R/W)
- LP_UART_SW_XON_INT_ENA** Write 1 to enable LP_UART_SW_XON_INT.(R/W)
- LP_UART_SW_XOFF_INT_ENA** Write 1 to enable LP_UART_SW_XOFF_INT. (R/W)
- LP_UART_GLITCH_DET_INT_ENA** Write 1 to enable LP_UART_GLITCH_DET_INT. (R/W)
- LP_UART_TX_BRK_DONE_INT_ENA** Write 1 to enable LP_UART_TX_BRK_DONE_INT. (R/W)
- LP_UART_TX_BRK_IDLE_DONE_INT_ENA** Write 1 to enable LP_UART_TX_BRK_IDLE_DONE_INT. (R/W)
- LP_UART_TX_DONE_INT_ENA** Write 1 to enable LP_UART_TX_DONE_INT. (R/W)
- LP_UART_AT_CMD_CHAR_DET_INT_ENA** Write 1 to enable LP_UART_AT_CMD_CHAR_DET_INT. (R/W)
- LP_UART_WAKEUP_INT_ENA** Write 1 to enable LP_UART_WAKEUP_INT. (R/W)

Register 26.43. LP_UART_INT_CLR_REG (0x0010)

(reserved)	LP_UART_WAKEUP_INT_CLR	LP_UART_AT_CMD_CHAR_DET_INT_CLR	(reserved)	LP_UART_TX_DONE_INT_CLR	LP_UART_TX_BRK_IDLE_DONE_INT_CLR	LP_UART_TX_BRK_DONE_INT_CLR	LP_UART_GLITCH_DET_INT_CLR	LP_UART_SW_XOFF_INT_CLR	LP_UART_SW_XON_INT_CLR	LP_UART_RXFIFO_TOUT_INT_CLR	LP_UART_CTS_DET_INT_CLR	LP_UART_DSR_CHG_INT_CLR	LP_UART_RXFIFO_CHG_INT_CLR	LP_UART_FRM_ERR_INT_CLR	LP_UART_PARITY_ERR_INT_CLR	LP_UART_TXFIFO_EMPTY_INT_CLR	LP_UART_RXFIFO_FULL_INT_CLR				
31	20	19	18	17	15	14	13	12	11	10	9	8	7	6	5	4	3	2	1	0	
0	0	0	0	0	0	0	0	0	0	0	0	0	0	0	0	0	0	0	0	0	Reset

- LP_UART_RXFIFO_FULL_INT_CLR** Write 1 to clear LP_UART_RXFIFO_FULL_INT. (WT)
- LP_UART_TXFIFO_EMPTY_INT_CLR** Write 1 to clear LP_UART_TXFIFO_EMPTY_INT. (WT)
- LP_UART_PARITY_ERR_INT_CLR** Write 1 to clear LP_UART_PARITY_ERR_INT. (WT)
- LP_UART_FRM_ERR_INT_CLR** Write 1 to clear LP_UART_FRM_ERR_INT. (WT)
- LP_UART_RXFIFO_OVF_INT_CLR** Write 1 to clear LP_UART_RXFIFO_OVF_INT. (WT)
- LP_UART_DSR_CHG_INT_CLR** Write 1 to clear LP_UART_DSR_CHG_INT. (WT)
- LP_UART_CTS_CHG_INT_CLR** Write 1 to clear LP_UART_CTS_CHG_INT. (WT)
- LP_UART_BRK_DET_INT_CLR** Write 1 to clear LP_UART_BRK_DET_INT. (WT)
- LP_UART_RXFIFO_TOUT_INT_CLR** Write 1 to clear LP_UART_RXFIFO_TOUT_INT. (WT)
- LP_UART_SW_XON_INT_CLR** Write 1 to clear LP_UART_SW_XON_INT. (WT)
- LP_UART_SW_XOFF_INT_CLR** Write 1 to clear LP_UART_SW_XOFF_INT. (WT)
- LP_UART_GLITCH_DET_INT_CLR** Write 1 to clear LP_UART_GLITCH_DET_INT. (WT)
- LP_UART_TX_BRK_DONE_INT_CLR** Write 1 to clear LP_UART_TX_BRK_DONE_INT. (WT)
- LP_UART_TX_BRK_IDLE_DONE_INT_CLR** Write 1 to clear LP_UART_TX_BRK_IDLE_DONE_INT. (WT)
- LP_UART_TX_DONE_INT_CLR** Write 1 to clear LP_UART_TX_DONE_INT. (WT)
- LP_UART_AT_CMD_CHAR_DET_INT_CLR** Write 1 to clear LP_UART_AT_CMD_CHAR_DET_INT. (WT)
- LP_UART_WAKEUP_INT_CLR** Write 1 to clear LP_UART_WAKEUP_INT. (WT)

Register 26.44. LP_UART_CLKDIV_SYNC_REG (0x0014)

(reserved)								LP_UART_CLKDIV_FRAG				(reserved)				LP_UART_CLKDIV							
31								24	23				20	19				12	11				0
0 0 0 0 0 0 0 0								0x0				0 0 0 0 0 0 0 0				0x2b6				Reset			

LP_UART_CLKDIV Configures the integral part of the divisor for baud rate generation. (R/W)

LP_UART_CLKDIV_FRAG Configures the fractional part of the divisor for baud rate generation. (R/W)

Register 26.45. LP_UART_RX_FILT_REG (0x0018)

(reserved)																LP_UART_GLITCH_FILT_EN		LP_UART_GLITCH_FILT		
31															9	8	7			0
0 0																0		0x8		Reset

LP_UART_GLITCH_FILT Configures the width of a pulse to be filtered.

Measurement unit: UART Core's clock cycle.

Pulses whose width is lower than this value will be ignored. (R/W)

LP_UART_GLITCH_FILT_EN Configures whether or not to enable RX signal filter.

0: Disable

1: Enable(R/W)

Register 26.46. LP_UART_CONF0_SYNC_REG (0x0020)

(reserved)								LP_UART_TXFIFO_RST LP_UART_RXFIFO_RST LP_UART_SW_FTS (reserved) LP_UART_MEM_CLK_EN LP_UART_ERR_WPR_MASK LP_UART_DIS_RX_DAT_INV LP_UART_TXD_INV (reserved) LP_UART_TX_FLOW_EN LP_UART_LOOPBACK								(reserved)								LP_UART_TXD_BRK LP_UART_STOP_BIT_NUM LP_UART_BIT_NUM LP_UART_PARITY_EN LP_UART_PARITY																
31							24	23	22	21	20	19	18	17	16	15	14	13	12	11									7	6	5	4	3	2	1	0				
0	0	0	0	0	0	0	0	0	0	0	1	0	0	0	0	0	0	0	0	0	0									0	0	1	3	0	0					Reset

LP_UART_PARITY Configures the parity check mode.

0: Even parity

1: Odd parity

(R/W)

LP_UART_PARITY_EN Configures whether or not to enable LP UART parity check.

0: Disable

1: Enable

(R/W)

LP_UART_BIT_NUM Configures the number of data bits.

0: 5 bits

1: 6 bits

2: 7 bits

3: 8 bits

(R/W)

LP_UART_STOP_BIT_NUM Configures the number of stop bits.

0: Invalid. No effect

1: 1 bit

2: 1.5 bits

3: 2 bits

(R/W)

LP_UART_TXD_BRK Configures whether or not to send NULL characters when finishing data transmission.

0: Not send

1: Send

(R/W)

LP_UART_LOOPBACK Configures whether or not to enable LP UART loopback test.

0: Disable

1: Enable

(R/W)

Continued on the next page...

Register 26.46. LP_UART_CONFO_SYNC_REG (0x0020)

Continued from the previous page...

LP_UART_TX_FLOW_EN Configures whether or not to enable flow control for the transmitter.

0: Disable

1: Enable

(R/W)

LP_UART_RXD_INV Configures whether or not to invert the level of LP UART RXD signal.

0: Not invert

1: Invert

(R/W)

LP_UART_TXD_INV Configures whether or not to invert the level of LP UART TXD signal.

0: Not invert

1: Invert

(R/W)

LP_UART_DIS_RX_DAT_OVF Configures whether or not to disable data overflow detection for the LP UART receiver.

0: Enable

1: Disable

(R/W)

LP_UART_ERR_WR_MASK Configures whether or not to store the received data with errors into FIFO.

0: Store

1: Not store

(R/W)

LP_UART_MEM_CLK_EN Configures whether or not to enable clock gating for LP UART memory.

0: Disable

1: Enable

(R/W)

LP_UART_SW_RTS Configures the RTS signal used in software flow control.

0: The LP UART transmitter is allowed to send data.

1: The LP UART transmitter is not allowed to send data.

(R/W)

LP_UART_RXFIFO_RST Configures whether or not to reset the LP UART RX FIFO.

0: Not reset

1: Reset

(R/W)

LP_UART_TXFIFO_RST Configures whether or not to reset the LP UART TX FIFO.

0: Not reset

1: Reset

(R/W)

Register 26.47. LP_UART_CONF1_REG (0x0024)

(reserved)										LP_UART_CLK_EN LP_UART_SW_DTR LP_UART_DTR_INV LP_UART_RTS_INV LP_UART_DSR_INV LP_UART_CTS_INV						LP_UART_TXFIFO_EMPTY_THRHD			(reserved)										LP_UART_RXFIFO_FULL_THRHD			(reserved)									
31											22	21	20	19	18	17	16	15				11	10	8	7				3	2	0										
0 0 0 0 0 0 0 0 0 0										0 0 0 0 0 0						0xc			0 0 0			0xc			0 0 0			Reset													

LP_UART_RXFIFO_FULL_THRHD Configures the threshold for RX FIFO being full.

Measurement unit: byte. (R/W)

LP_UART_TXFIFO_EMPTY_THRHD Configures the threshold for TX FIFO being empty.

Measurement unit: byte. (R/W)

LP_UART_CTS_INV Configures whether or not to invert the level of LP UART CTS signal.

0: Not invert

1: Invert

(R/W)

LP_UART_DSR_INV Configures whether or not to invert the level of LP UART DSR signal.

0: Not invert

1: Invert

(R/W)

LP_UART_RTS_INV Configures whether or not to invert the level of LP UART RTS signal.

0: Not invert

1: Invert

(R/W)

LP_UART_DTR_INV Configures whether or not to invert the level of LP UART DTR signal.

0: Not invert

1: Invert

(R/W)

LP_UART_SW_DTR Configures the DTR signal used in software flow control.

0: Data to be transmitted is not ready.

1: Data to be transmitted is ready.

(R/W)

LP_UART_CLK_EN Configures clock gating.

0: Support clock only when the application writes registers.

1: Always force the clock on for registers.

(R/W)

Register 26.48. LP_UART_HWFC_CONF_SYNC_REG (0x002C)

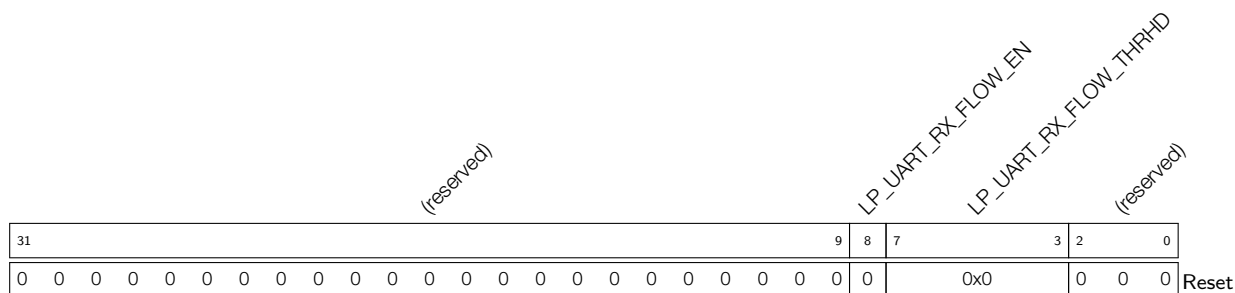

LP_UART_RX_FLOW_THRHD Configures the maximum number of data bytes that can be received during hardware flow control. Measurement unit: byte. (R/W)

LP_UART_RX_FLOW_EN Configures whether or not to enable the LP UART receiver.
 0: Disable
 1: Enable
 (R/W)

Register 26.49. LP_UART_SLEEP_CONF0_REG (0x0030)

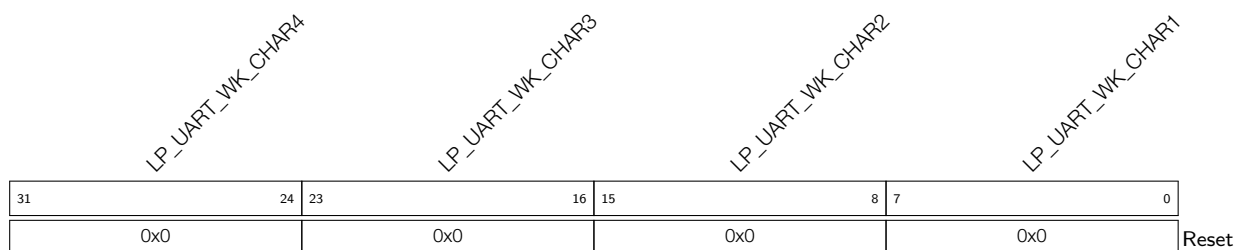

LP_UART_WK_CHAR1 Configures wakeup character 1. (R/W)
LP_UART_WK_CHAR2 Configures wakeup character 2. (R/W)
LP_UART_WK_CHAR3 Configures wakeup character 3. (R/W)
LP_UART_WK_CHAR4 Configures wakeup character 4. (R/W)

Register 26.50. LP_UART_SLEEP_CONF1_REG (0x0034)

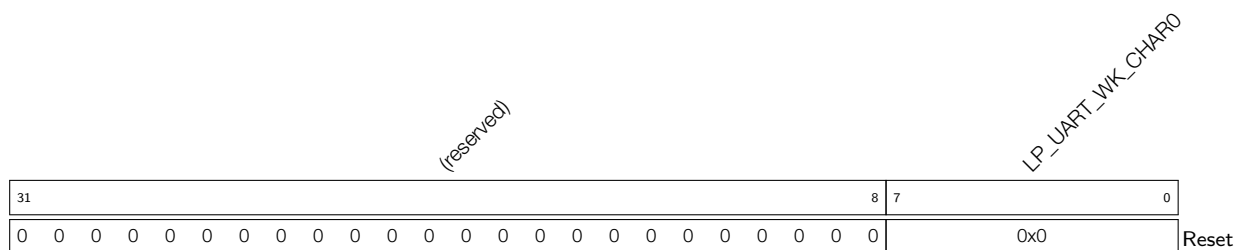

LP_UART_WK_CHAR0 Configures wakeup character 0. (R/W)

Register 26.51. LP_UART_SLEEP_CONF2_REG (0x0038)

(reserved)				LP_UART_WK_MODE_SEL		LP_UART_WK_CHAR_MASK		LP_UART_WK_CHAR_NUM		LP_UART_RX_WAKE_UP_THRHD			(reserved)				LP_UART_ACTIVE_THRESHOLD			
31	28	27	26	25	21	20	18	17	13	12	10	9					0			
0	0	0	0	0	0x0	0x5		1		0	0	0					0xf0			

Reset

LP_UART_ACTIVE_THRESHOLD Configures the number of RXD edge changes to wake up the chip in wakeup mode 0. (R/W)

LP_UART_RX_WAKE_UP_THRHD Configures the number of received data bytes to wake up the chip in wakeup mode 1. (R/W)

LP_UART_WK_CHAR_NUM Configures the number of wakeup characters. (R/W)

LP_UART_WK_CHAR_MASK Configures whether or not to mask wakeup characters.

0: Not mask

1: Mask

(R/W)

LP_UART_WK_MODE_SEL Configures which wakeup mode to select.

0: Mode 0

1: Mode 1

2: Mode 2

3: Mode 3

(R/W)

Register 26.52. LP_UART_SWFC_CONF0_SYNC_REG (0x003C)

(reserved)										LP_UART_SEND_XOFF										LP_UART_SEND_XON										LP_UART_FORCE_XON										LP_UART_FORCE_XOFF										LP_UART_XONOFF_DEL										LP_UART_SW_FLOW_CON_EN										LP_UART_XON_XOFF_STILL_SEND										LP_UART_XOFF_CHAR										LP_UART_XON_CHAR									
31									23	22	21	20	19	18	17	16	15									8	7									0																																																															
0										0										0x13										0x11										Reset																																																											

LP_UART_XON_CHAR Configures the XON character for flow control. (R/W)

LP_UART_XOFF_CHAR Configures the XOFF character for flow control. (R/W)

LP_UART_XON_XOFF_STILL_SEND Configures whether the LP UART transmitter can send XON or XOFF characters when it is disabled.

0: Cannot send

1: Can send

(R/W)

LP_UART_SW_FLOW_CON_EN Configures whether or not to enable software flow control.

0: Disable

1: Enable

(R/W)

LP_UART_XONOFF_DEL Configures whether or not to remove flow control characters from the received data.

0: Not move

1: Move

(R/W)

LP_UART_FORCE_XON Configures whether the transmitter continues to sending data.

0: Not send

1: Send

(R/W)

LP_UART_FORCE_XOFF Configures whether or not to stop the transmitter from sending data.

0: Not stop

1: Stop

(R/W)

LP_UART_SEND_XON Configures whether or not to send XON characters.

0: Not send

1: Send

(R/W/SS/SC)

LP_UART_SEND_XOFF Configures whether or not to send XOFF characters.

0: Not send

1: Send

(R/W/SS/SC)

Register 26.53. LP_UART_SWFC_CONF1_REG (0x0040)

(reserved)																LP_UART_XOFF_THRESHOLD				(reserved)				LP_UART_XON_THRESHOLD				(reserved)				
31															16	15					11	10	8	7					3	2	0	
0																0xc				0				0x0				0				Reset

LP_UART_XON_THRESHOLD Configures the threshold for data in RX FIFO to send XON characters in software flow control.

Measurement unit: byte. (R/W)

LP_UART_XOFF_THRESHOLD Configures the threshold for data in RX FIFO to send XOFF characters in software flow control.

Measurement unit: byte. (R/W)

Register 26.54. LP_UART_TXBRK_CONF_SYNC_REG (0x0044)

(reserved)																								LP_UART_TX_BRK_NUM				
31																							8	7			0	
0																								0xa				Reset

LP_UART_TX_BRK_NUM Configures the number of NULL characters to be sent after finishing data transmission.

Valid only when LP_UART_TXD_BRK is 1. (R/W)

Register 26.55. LP_UART_IDLE_CONF_SYNC_REG (0x0048)

<i>(reserved)</i>										<i>LP_UART_TX_IDLE_NUM</i>										<i>LP_UART_RX_IDLE_THRHD</i>															
31											20	19											10	9											0
0 0 0 0 0 0 0 0 0 0										0x100										0x100										Reset					

LP_UART_RX_IDLE_THRHD Configures the threshold to generate a frame end signal when the receiver takes more time to receive one data byte data.

Measurement unit: bit time (the time to transmit 1 bit). (R/W)

LP_UART_TX_IDLE_NUM Configures the interval between two data transfers.

Measurement unit: bit time (the time to transmit 1 bit). (R/W)

Register 26.56. LP_UART_DELAY_CONF_SYNC_REG (0x004C)

<i>(reserved)</i>																												<i>LP_UART_DL1_EN</i>		<i>LP_UART_DL0_EN</i>		<i>(reserved)</i>																									
31																											3	2	1	0																											Reset
0 0																												0	0	0	0																										

LP_UART_DL0_EN Configures whether or not to add a turnaround delay of 1 bit before the start bit.

0: Not add

1: Add

(R/W)

LP_UART_DL1_EN Configures whether or not to add a turnaround delay of 1 bit after the stop bit.

0: Not add

1: Add

(R/W)

Register 26.57. LP_UART_CLK_CONF_REG (0x0088)

(reserved)				LP_UART_RX_RST_CORE LP_UART_TX_RST_CORE LP_UART_RX_SCLK_EN LP_UART_TX_SCLK_EN				(reserved)															
31	28	27	26	25	24	23																	0
0	0	0	0	0	1	1	0																Reset

LP_UART_TX_SCLK_EN Configures whether or not to enable LP UART TX clock.

0: Disable

1: Enable

(R/W)

LP_UART_RX_SCLK_EN Configures whether or not to enable LP UART RX clock.

0: Disable

1: Enable

(R/W)

LP_UART_TX_RST_CORE Write 1 and then write 0 to reset LP UART TX. (R/W)

LP_UART_RX_RST_CORE Write 1 and then write 0 to reset LP UART RX. (R/W)

Register 26.58. LP_UART_STATUS_REG (0x001C)

LP_UART_TXD LP_UART_RTSN LP_UART_DTRN				(reserved)				LP_UART_TXFIFO_CNT				(reserved)				LP_UART_RXD LP_UART_CTSN LP_UART_DSRN				LP_UART_RXFIFO_CNT				(reserved)									
31	30	29	28					24	23					19	18	16	15	14	13	12					8	7					3	2	0
1	1	1	0	0	0	0	0	0	0	0	0	0	1	1	0	0	0	0	0	0	0	0	0	0	0	0	0	0	0	Reset			

LP_UART_RXFIFO_CNT Represents the number of valid data bytes in RX FIFO. (RO)

LP_UART_DSRN Represents the level of the internal LP UART DSR signal. (RO)

LP_UART_CTSN Represents the level of the internal LP UART CTS signal. (RO)

LP_UART_RXD Represents the level of the internal LP UART RXD signal. (RO)

LP_UART_TXFIFO_CNT Represents the number of valid data bytes in TX FIFO. (RO)

LP_UART_DTRN Represents the level of the internal LP UART DTR signal. (RO)

LP_UART_RTSN Represents the level of the internal LP UART RTS signal. (RO)

LP_UART_TXD Represents the level of the internal LP UART TXD signal. (RO)

Register 26.59. LP_UART_MEM_TX_STATUS_REG (0x0068)

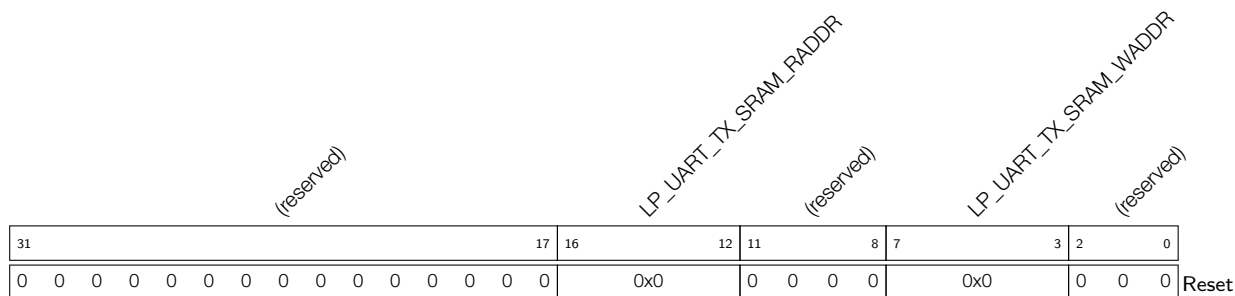

LP_UART_TX_SRAM_WADDR Represents the offset address to write TX FIFO. (RO)

LP_UART_TX_SRAM_RADDR Represents the offset address to read TX FIFO. (RO)

Register 26.60. LP_UART_MEM_RX_STATUS_REG (0x006C)

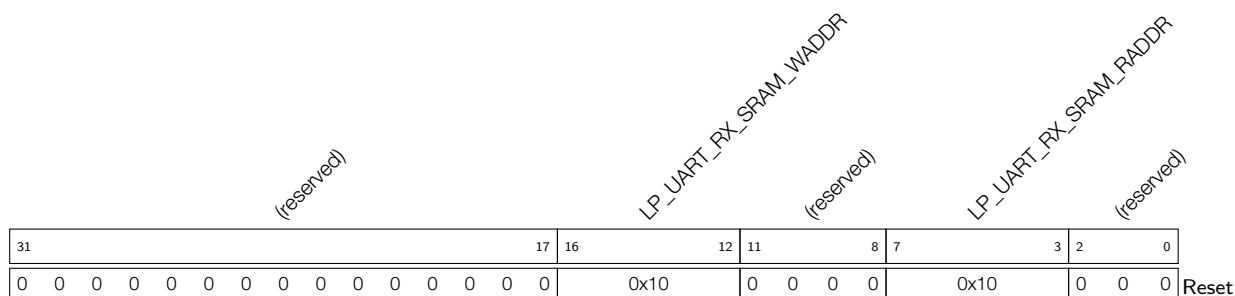

LP_UART_RX_SRAM_RADDR Represents the offset address to read RX FIFO. (RO)

LP_UART_RX_SRAM_WADDR Represents the offset address to write RX FIFO. (RO)

Register 26.61. LP_UART_FSM_STATUS_REG (0x0070)

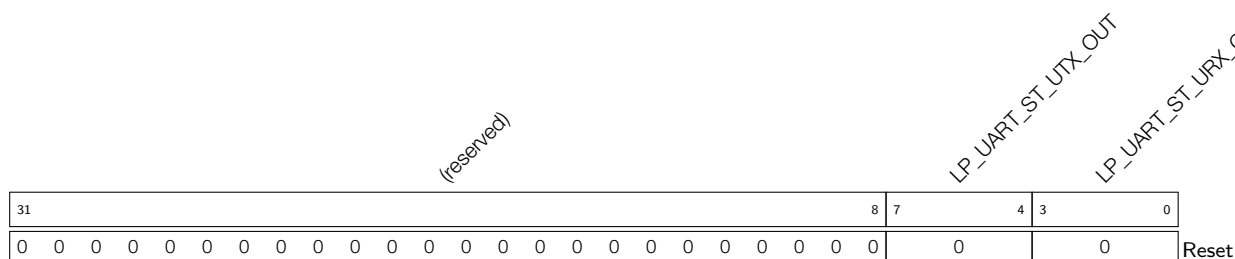

LP_UART_ST_URX_OUT Represents the status of the receiver. (RO)

LP_UART_ST_UTX_OUT Represents the status of the transmitter. (RO)

Register 26.62. LP_UART_AFIFO_STATUS_REG (0x0090)

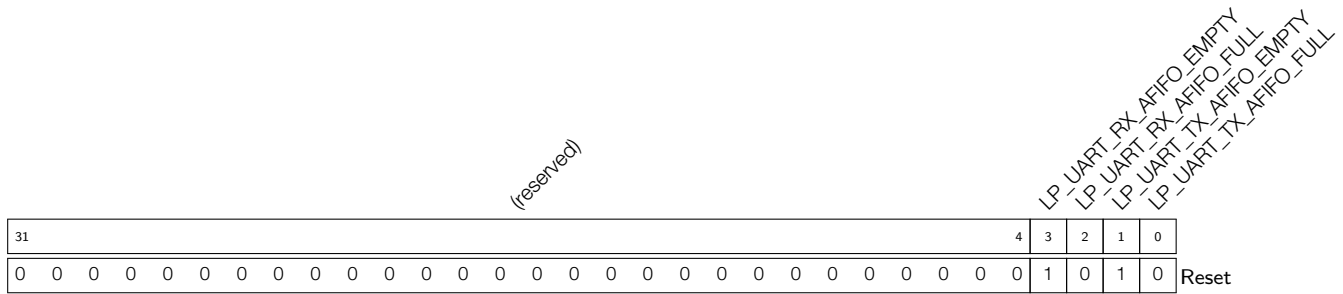

LP_UART_TX_AFIFO_FULL Represents whether or not the APB TX asynchronous FIFO is full.
 0: Not full
 1: Full
 (RO)

LP_UART_TX_AFIFO_EMPTY Represents whether or not the APB TX asynchronous FIFO is empty.
 0: Not empty
 1: Empty
 (RO)

LP_UART_RX_AFIFO_FULL Represents whether or not the APB RX asynchronous FIFO is full.
 0: Not full
 1: Full
 (RO)

LP_UART_RX_AFIFO_EMPTY Represents whether or not the APB RX asynchronous FIFO is empty.
 0: Not empty
 1: Empty
 (RO)

Register 26.63. LP_UART_AT_CMD_PRECNT_SYNC_REG (0x0050)

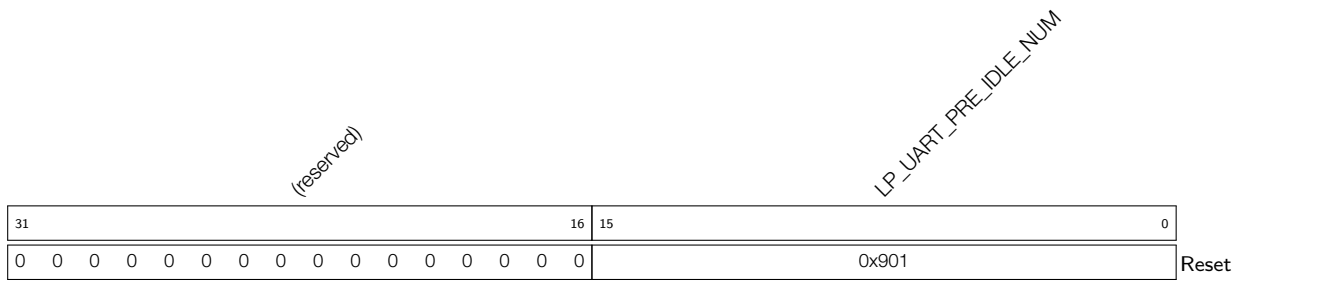

LP_UART_PRE_IDLE_NUM Configures the idle time before the receiver receives the first AT_CMD.
 Measurement unit: bit time (the time to transmit 1 bit). (R/W)

Register 26.64. LP_UART_AT_CMD_POSTCNT_SYNC_REG (0x0054)

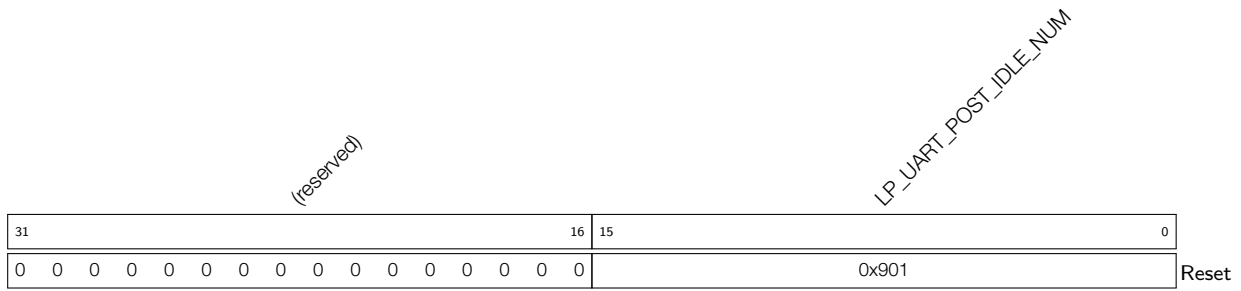

LP_UART_POST_IDLE_NUM Configures the interval between the last AT_CMD and subsequent data.

Measurement unit: bit time (the time to transmit 1 bit). (R/W)

Register 26.65. LP_UART_AT_CMD_GAP_TOUT_SYNC_REG (0x0058)

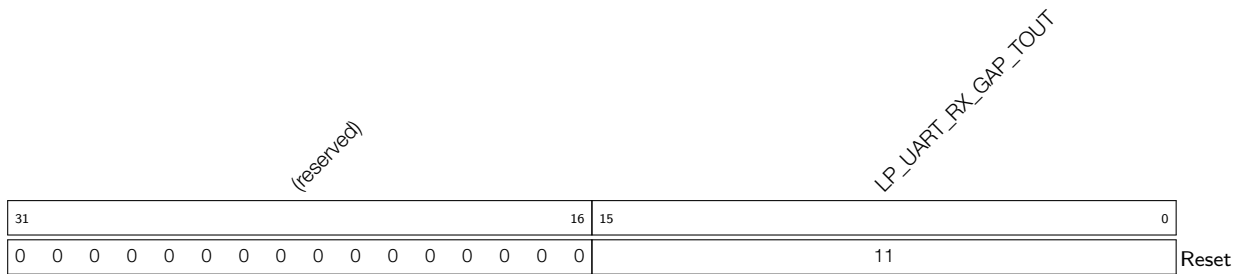

LP_UART_RX_GAP_TOUT Configures the interval between two AT_CMD characters.

Measurement unit: bit time (the time to transmit 1 bit). (R/W)

Register 26.66. LP_UART_AT_CMD_CHAR_SYNC_REG (0x005C)

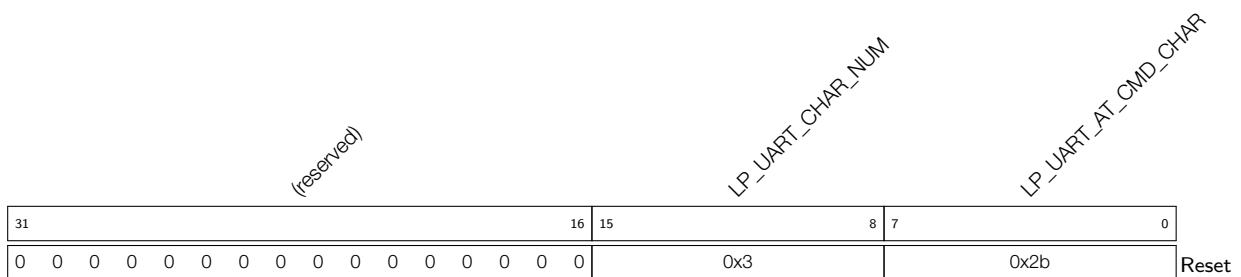

LP_UART_AT_CMD_CHAR Configures the AT_CMD character. (R/W)

LP_UART_CHAR_NUM Configures the number of continuous AT_CMD characters a receiver can receive. (R/W)

Register 26.67. LP_UART_DATE_REG (0x008C)

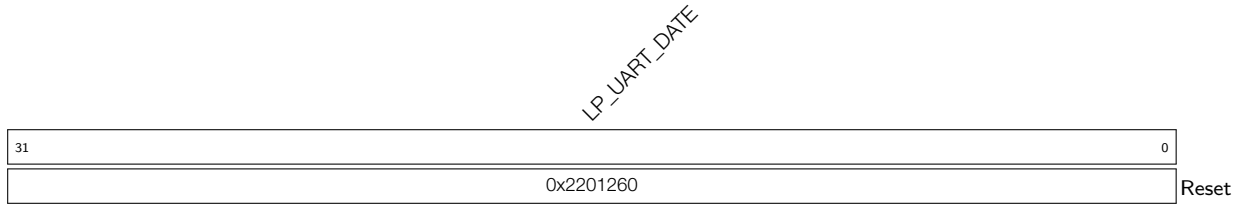

LP_UART_DATE Version control register. (R/W)

Register 26.68. LP_UART_REG_UPDATE_REG (0x0098)

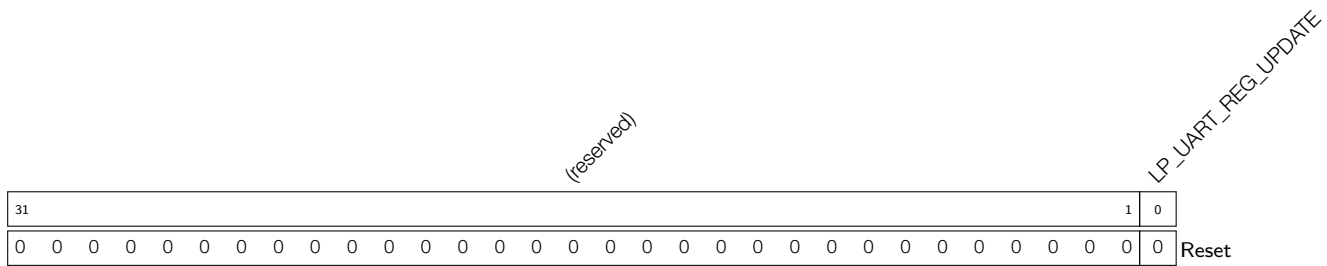

LP_UART_REG_UPDATE Configures whether or not to synchronize registers.

0: Not synchronize

1: Synchronize

(R/W/SC)

Register 26.69. LP_UART_ID_REG (0x009C)

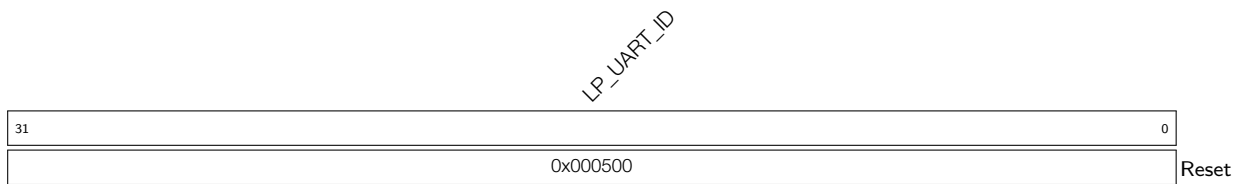

LP_UART_ID Configures the LP UART ID. (R/W)

26.7.3 UHCI Registers

The addresses in this section are relative to UHCI base address provided in Table 5-2 in Chapter 5 *System and Memory*.

Register 26.70. UHCI_CONF0_REG (0x0000)

(reserved)														UHCI_UART_PX_BRK_EOF_EN	UHCI_CLK_EN	UHCI_ENCODE_CRC_EN	UHCI_LEN_EOF_EN	UHCI_UART_IDLE_EN	UHCI_CRC_REC_EN	UHCI_HEAD_EN	(reserved)	UHCI_SEPER_EN	UHCI_UART1_CE	UHCI_UART0_CE	UHCI_PX_RST	UHCI_TX_RST		
31													13	12	11	10	9	8	7	6	5	4	3	2	1	0	Reset	
0 0 0 0 0 0 0 0 0 0 0 0 0 0														0	0	1	1	0	1	1	1	0	0	0	0	0	0	

UHCI_TX_RST Write 1 and then write 0 to reset the decoder state machine. (R/W)

UHCI_RX_RST Write 1 and then write 0 to reset the encoder state machine. (R/W)

UHCI_UART0_CE Configures whether or not to connect UHCI with UART0.

0: Not connect

1: Connect

(R/W)

UHCI_UART1_CE Configures whether or not to connect UHCI with UART1.

0: Not connect

1: Connect

(R/W)

UHCI_SEPER_EN Configures whether or not to separate the data frame with a special character.

0: Not separate

1: Separate

(R/W)

UHCI_HEAD_EN Configures whether or not to encode the data packet with a formatting header.

0: Not use formatting header

1: Use formatting header

(R/W)

UHCI_CRC_REC_EN Configures whether or not to enable the reception of the 16-bit CRC.

0: Disable

1: Enable

(R/W)

UHCI_UART_IDLE_EOF_EN Configures whether or not to stop receiving data when UART is idle.

0: Not stop

1: Stop

(R/W)

UHCI_LEN_EOF_EN Configures when the UHCI decoder stops receiving data.

0: Stops after receiving 0xC0

1: Stops when the number of received data bytes reach the specified value. When UHCI_HEAD_EN is 1, the specified value is the data length indicated by the UHCI packet header; when UHCI_HEAD_EN is 0, the specified value is the configured value.

(R/W)

Continued on the next page...

Register 26.70. UHCI_CONF0_REG (0x0000)

Continued from the previous page...

UHCI_ENCODE_CRC_EN Configures whether or not to enable data integrity check by appending a 16 bit CCITT-CRC to the end of the data.

0: Disable

1: Enable

(R/W)

UHCI_CLK_EN Configures clock gating.

0: Support clock only when the application writes registers.

1: Always force the clock on for registers.

(R/W)

UHCI_UART_RX_BRK_EOF_EN Configures whether or not to stop UHCI from receiving data after UART has received a NULL frame.

0: Not stop

1: Stop

(R/W)

Register 26.71. UHCI_CONF1_REG (0x0014)

(reserved)										UHCI_SW_START UHCI_WAIT_SW_START (reserved) UHCI_TX_ACK_NUM_RE UHCI_TX_CHECK_SUM_RE UHCI_SAVE_HEAD UHCI_CRC_DISABLE UHCI_CHECK_SEQ_EN UHCI_CHECK_SUM_EN																			
31										9	8	7	6	5	4	3	2	1	0										
0										0										0	0	0	1	1	0	0	1	1	Reset

UHCI_CHECK_SUM_EN Configures whether or not to enable header checksum validation when UHCI receives a data packet.

0: Disable

1: Enable

(R/W)

UHCI_CHECK_SEQ_EN Configures whether or not to enable the sequence number check when UHCI receives a data packet.

0: Disable

1: Enable

(R/W)

UHCI_CRC_DISABLE Configures whether or not to enable CRC calculation.

0: Disable

1: Enable

Valid only when the Data Integrity Check Present bit in UHCI packet is 1.

(R/W)

UHCI_SAVE_HEAD Configures whether or not to save the packet header when UHCI receives a data packet.

0: Not save

1: Save

(R/W)

UHCI_TX_CHECK_SUM_RE Configures whether or not to encode the data packet with a checksum.

0: Not use checksum

1: Use checksum

(R/W)

UHCI_TX_ACK_NUM_RE Configures whether or not to encode the data packet with an acknowledgment when a reliable packet is to be transmitted.

0: Not use acknowledgement

1: Use acknowledgement

(R/W)

Continued on the next page...

Register 26.71. UHCI_CONF1_REG (0x0014)

Continued from the previous page...

UHCI_WAIT_SW_START Configures whether or not to put the UHCI encoder state machine to ST_SW_WAIT state.

0: No

1: Yes

(R/W)

UHCI_SW_START Configures whether or not to send data packets when the encoder state machine is in ST_SW_WAIT state.

0: Not send

1: Send

(R/W/SC)

Register 26.72. UHCI_ESCAPE_CONF_REG (0x0020)

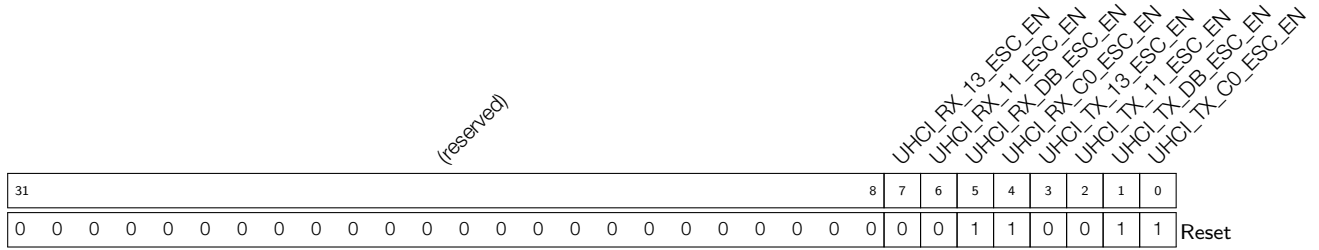

UHCI_TX_C0_ESC_EN Configures whether or not to decode character 0xC0 when DMA receives data.
 0: Not decode
 1: Decode
 (R/W)

UHCI_TX_DB_ESC_EN Configures whether or not to decode character 0xDB when DMA receives data.
 0: Not decode
 1: Decode
 (R/W)

UHCI_TX_11_ESC_EN Configures whether or not to decode flow control character 0x11 when DMA receives data.
 0: Not decode
 1: Decode
 (R/W)

UHCI_TX_13_ESC_EN Configures whether or not to decode flow control character 0x13 when DMA receives data.
 0: Not decode
 1: Decode
 (R/W)

UHCI_RX_C0_ESC_EN Configures whether or not to replace 0xC0 by special characters when DMA sends data.
 0: Not replace
 1: Replace
 (R/W)

UHCI_RX_DB_ESC_EN Configures whether or not to replace 0xDB by special characters when DMA sends data.
 0: Not replace
 1: Replace
 (R/W)

Continued on the next page...

Register 26.72. UHCI_ESCAPE_CONF_REG (0x0020)

Continued from the previous page...

UHCI_RX_11_ESC_EN Configures whether or not to replace flow control character 0x11 by special characters when DMA sends data.

0: Not replace

1: Replace

(R/W)

UHCI_RX_13_ESC_EN Configures whether or not to replace flow control character 0x13 by special characters when DMA sends data.

0: Not replace

1: Replace

(R/W)

Register 26.73. UHCI_HUNG_CONF_REG (0x0024)

(reserved)								UHCI_RXFIFO_TIMEOUT_ENA				UHCI_RXFIFO_TIMEOUT_SHIFT				UHCI_RXFIFO_TIMEOUT				UHCI_TXFIFO_TIMEOUT_ENA				UHCI_TXFIFO_TIMEOUT_SHIFT				UHCI_TXFIFO_TIMEOUT			
31								24	23	22	20	19				12	11	10	8	7				0							
0	0	0	0	0	0	0	0	1	0	0x10				1	0	0x10				Reset											

UHCI_TXFIFO_TIMEOUT Configures the timeout value for DMA data reception.

Measurement unit: ms. (R/W)

UHCI_TXFIFO_TIMEOUT_SHIFT Configures the upper limit of the timeout counter for TX FIFO. (R/W)

UHCI_TXFIFO_TIMEOUT_ENA Configures whether or not to enable the data reception timeout for TX FIFO.

0: Disable

1: Enable

(R/W)

UHCI_RXFIFO_TIMEOUT Configures the timeout value for DMA to read data from RAM.

Measurement unit: ms. (R/W)

UHCI_RXFIFO_TIMEOUT_SHIFT Configures the upper limit of the timeout counter for RX FIFO.

(R/W)

UHCI_RXFIFO_TIMEOUT_ENA Configures whether or not to enable the DMA data transmission timeout.

0: Disable

1: Enable

(R/W)

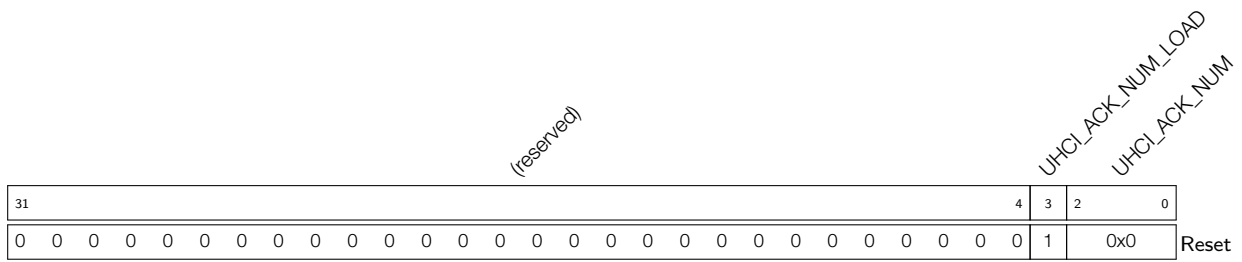
Register 26.74. UHCI_ACK_NUM_REG (0x0028)

UHCI_ACK_NUM Configures the number of acknowledgements used in software flow control. (R/W)

UHCI_ACK_NUM_LOAD Configures whether or not load acknowledgements.

0: Not load

1: Load

(WT)

Register 26.75. UHCI_QUICK_SENT_REG (0x0030)

(reserved)																UHCI_ALWAYS_SEND_EN		UHCI_ALWAYS_SEND_NUM		UHCI_SINGLE_SEND_EN		UHCI_SINGLE_SEND_NUM	
31																8	7	6	4	3	2	0	
0	0	0	0	0	0	0	0	0	0	0	0	0	0	0	0	0	0	0x0	0	0	0x0		Reset

UHCI_SINGLE_SEND_NUM Configures the source of data to be transmitted in single_send mode.

- 0: Q0 register
 - 1: Q1 register
 - 2: Q2 register
 - 3: Q3 register
 - 4: Q4 register
 - 5: Q5 register
 - 6: Q6 register
 - 7: Invalid. No effect
- (R/W)

UHCI_SINGLE_SEND_EN Configures whether or not to enable single_send mode.

- 0: Disable
 - 1: Enable
- (R/W/SC)

UHCI_ALWAYS_SEND_NUM Configures the source of data to be transmitted in always_send mode.

- 0: Q0 register
 - 1: Q1 register
 - 2: Q2 register
 - 3: Q3 register
 - 4: Q4 register
 - 5: Q5 register
 - 6: Q6 register
 - 7: Invalid. No effect
- (R/W)

UHCI_ALWAYS_SEND_EN Configures whether or not to enable always_send mode.

- 0: Disable
 - 1: Enable
- (R/W)

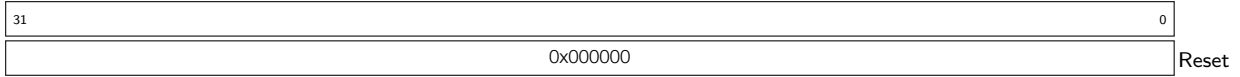
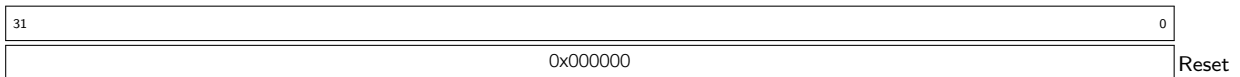
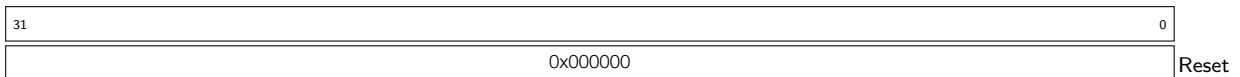
Register 26.76. UHCI_REG_Q0_WORD0_REG (0x0034)*UHCI_SEND_Q0_WORD0***UHCI_SEND_Q0_WORD0** Data to be transmitted in Q0 register. (R/W)**Register 26.77. UHCI_REG_Q0_WORD1_REG (0x0038)***UHCI_SEND_Q0_WORD1***UHCI_SEND_Q0_WORD1** Data to be transmitted in Q0 register. (R/W)**Register 26.78. UHCI_REG_Q1_WORD0_REG (0x003C)***UHCI_SEND_Q1_WORD0***UHCI_SEND_Q1_WORD0** Data to be transmitted in Q1 register. (R/W)

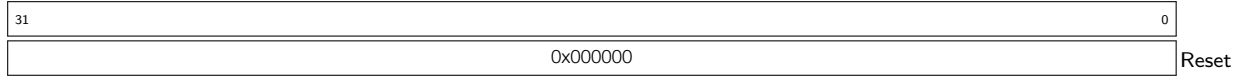
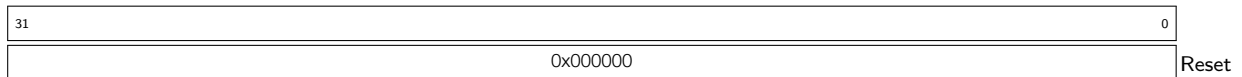
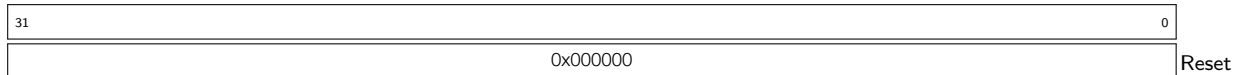
Register 26.79. UHCI_REG_Q1_WORD1_REG (0x0040)*UHCI_SEND_Q1_WORD1***UHCI_SEND_Q1_WORD1** Data to be transmitted in Q1 register. (R/W)**Register 26.80. UHCI_REG_Q2_WORD0_REG (0x0044)***UHCI_SEND_Q2_WORD0***UHCI_SEND_Q2_WORD0** Data to be transmitted in Q2 register. (R/W)**Register 26.81. UHCI_REG_Q2_WORD1_REG (0x0048)***UHCI_SEND_Q2_WORD1***UHCI_SEND_Q2_WORD1** Data to be transmitted in Q2 register. (R/W)

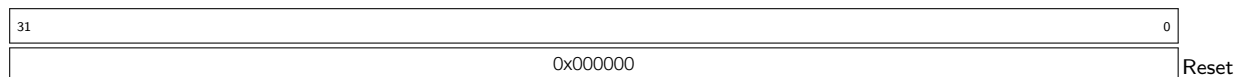
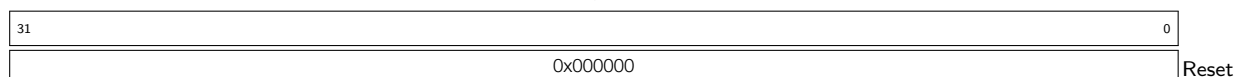
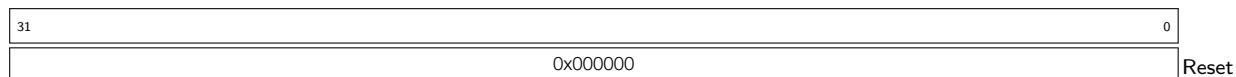
Register 26.82. UHCI_REG_Q3_WORD0_REG (0x004C)*UHCI_SEND_Q3_WORD0***UHCI_SEND_Q3_WORD0** Data to be transmitted in Q3 register. (R/W)**Register 26.83. UHCI_REG_Q3_WORD1_REG (0x0050)***UHCI_SEND_Q3_WORD1***UHCI_SEND_Q3_WORD1** Data to be transmitted in Q3 register. (R/W)**Register 26.84. UHCI_REG_Q4_WORD0_REG (0x0054)***UHCI_SEND_Q4_WORD0***UHCI_SEND_Q4_WORD0** Data to be transmitted in Q4 register. (R/W)

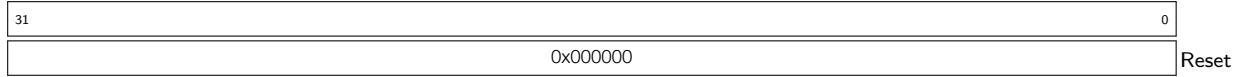
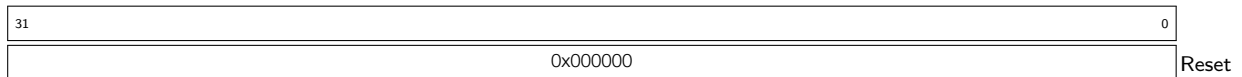
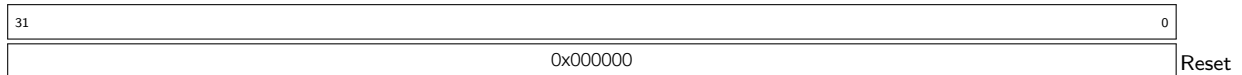
Register 26.85. UHCI_REG_Q4_WORD1_REG (0x0058)*UHCI_SEND_Q4_WORD1***UHCI_SEND_Q4_WORD1** Data to be transmitted in Q4 register. (R/W)**Register 26.86. UHCI_REG_Q5_WORD0_REG (0x005C)***UHCI_SEND_Q5_WORD0***UHCI_SEND_Q5_WORD0** Data to be transmitted in Q5 register. (R/W)**Register 26.87. UHCI_REG_Q5_WORD1_REG (0x0060)***UHCI_SEND_Q5_WORD1***UHCI_SEND_Q5_WORD1** Data to be transmitted in Q5 register. (R/W)

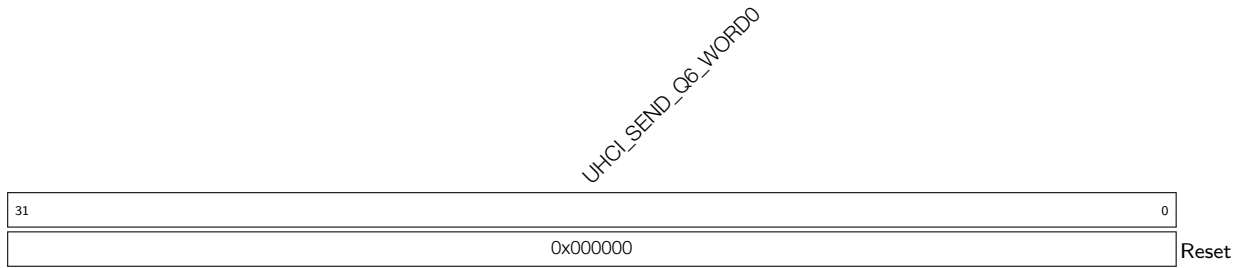
Register 26.88. UHCI_REG_Q6_WORD0_REG (0x0064)

UHCI_SEND_Q6_WORD0 Data to be transmitted in Q6 register. (R/W)

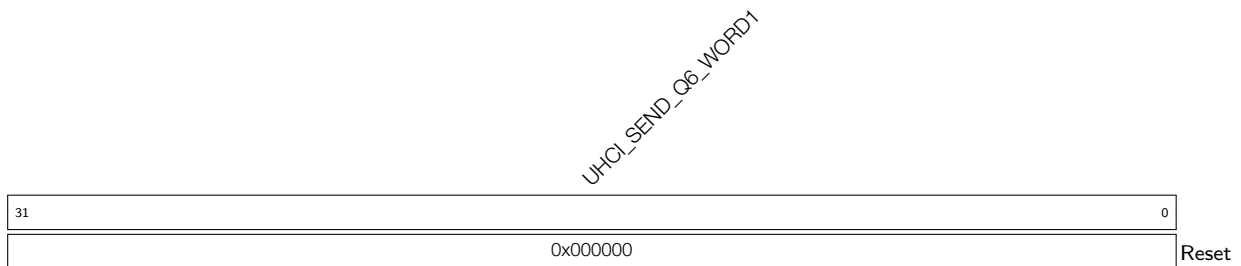
Register 26.89. UHCI_REG_Q6_WORD1_REG (0x0068)

UHCI_SEND_Q6_WORD1 Data to be transmitted in Q6 register. (R/W)

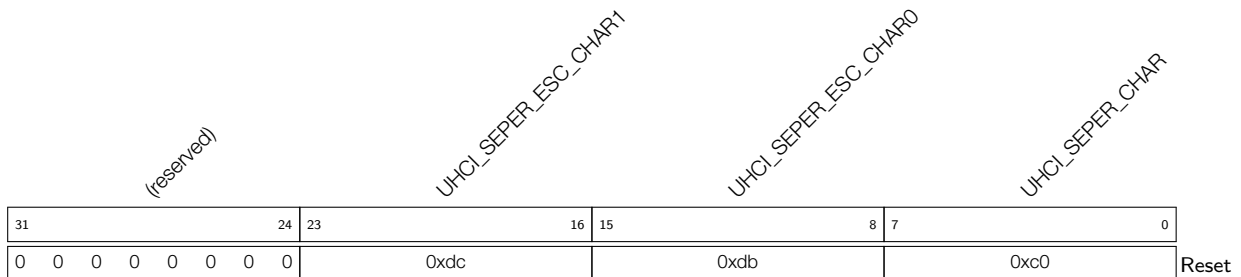
Register 26.90. UHCI_ESC_CONF0_REG (0x006C)

UHCI_SEPER_CHAR Configures separators to encode data packets. The default value is 0xC0. (R/W)

UHCI_SEPER_ESC_CHAR0 Configures the first character of SLIP escape sequence. The default value is 0xDB. (R/W)

UHCI_SEPER_ESC_CHAR1 Configures the second character of SLIP escape sequence. The default value is 0xDC. (R/W)

Register 26.91. UHCI_ESC_CONF1_REG (0x0070)

<i>(reserved)</i>								<i>UHCI_ESC_SEQ0_CHAR1</i>								<i>UHCI_ESC_SEQ0_CHAR0</i>								<i>UHCI_ESC_SEQ0</i>											
31								24	23								16	15								8	7								0
0 0 0 0 0 0 0 0								0xdd								0xdb								0xdb								Reset			

UHCI_ESC_SEQ0 Configures the character that needs to be encoded. The default value is 0xDB used as the first character of SLIP escape sequence. (R/W)

UHCI_ESC_SEQ0_CHAR0 Configures the first character of SLIP escape sequence. The default value is 0xDB. (R/W)

UHCI_ESC_SEQ0_CHAR1 Configures the second character of SLIP escape sequence. The default value is 0xDD. (R/W)

Register 26.92. UHCI_ESC_CONF2_REG (0x0074)

<i>(reserved)</i>								<i>UHCI_ESC_SEQ1_CHAR1</i>								<i>UHCI_ESC_SEQ1_CHAR0</i>								<i>UHCI_ESC_SEQ1</i>											
31								24	23								16	15								8	7								0
0 0 0 0 0 0 0 0								0xde								0xdb								0x11								Reset			

UHCI_ESC_SEQ1 Configures a character that need to be encoded. The default value is 0x11 used as a flow control character. (R/W)

UHCI_ESC_SEQ1_CHAR0 Configures the first character of SLIP escape sequence. The default value is 0xDB. (R/W)

UHCI_ESC_SEQ1_CHAR1 Configures the second character of SLIP escape sequence. The default value is 0xDE. (R/W)

Register 26.93. UHCI_ESC_CONF3_REG (0x0078)

<i>(reserved)</i>								<i>UHCI_ESC_SEQ2_CHAR1</i>								<i>UHCI_ESC_SEQ2_CHAR0</i>								<i>UHCI_ESC_SEQ2</i>											
31								24	23								16	15								8	7								0
0 0 0 0 0 0 0 0								0xdf								0xdb								0x13								Reset			

UHCI_ESC_SEQ2 Configures the character that needs to be decoded. The default value is 0x13 used as a flow control character. (R/W)

UHCI_ESC_SEQ2_CHAR0 Configures the first character of SLIP escape sequence. The default value is 0xDB. (R/W)

UHCI_ESC_SEQ2_CHAR1 Configures the second character of SLIP escape sequence. The default value is 0xDF. (R/W)

Register 26.94. UHCI_PKT_THRES_REG (0x007C)

<i>(reserved)</i>																<i>UHCI_PKT_THRS</i>																	
31																13	12																0
0 0 0 0 0 0 0 0 0 0 0 0 0 0 0 0																0x80																Reset	

UHCI_PKT_THRS Configures the maximum value of the packet length.

Measurement unit: byte.

Valid only when UHCI_HEAD_EN is 0. (R/W)

Register 26.95. UHCI_INT_RAW_REG (0x0004)

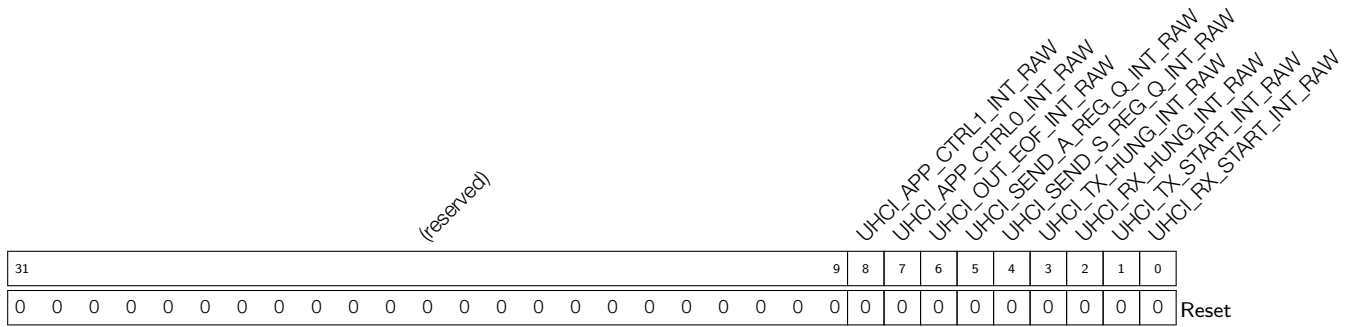

UHCI_RX_START_INT_RAW The raw interrupt status of UHCI_RX_START_INT. (R/WTC/SS)

UHCI_TX_START_INT_RAW The raw interrupt status of UHCI_TX_START_INT. (R/WTC/SS)

UHCI_RX_HUNG_INT_RAW The raw interrupt status of UHCI_RX_HUNG_INT. (R/WTC/SS)

UHCI_TX_HUNG_INT_RAW The raw interrupt status of UHCI_TX_HUNG_INT. (R/WTC/SS)

UHCI_SEND_S_REG_Q_INT_RAW The raw interrupt status of UHCI_SEND_S_REG_Q_INT. (R/WTC/SS)

UHCI_SEND_A_REG_Q_INT_RAW The raw interrupt status of UHCI_SEND_A_REG_Q_INT. (R/WTC/SS)

UHCI_OUT_EOF_INT_RAW The raw interrupt status of UHCI_OUT_EOF_INT. (R/WTC/SS)

UHCI_APP_CTRL0_INT_RAW The raw interrupt status of UHCI_APP_CTRL0_INT. (R/W)

UHCI_APP_CTRL1_INT_RAW The raw interrupt status of UHCI_APP_CTRL1_INT. (R/W)

Register 26.96. UHCI_INT_ST_REG (0x0008)

(reserved)										UHCI_APP_CTRL1_INT_ST UHCI_APP_CTRL0_INT_ST UHCI_OUTLINK_EOF_ERR_INT_ST UHCI_SEND_A_REG_Q_INT_ST UHCI_SEND_S_REG_Q_INT_ST UHCI_TX_HUNG_INT_ST UHCI_RX_HUNG_INT_ST UHCI_TX_START_INT_ST UHCI_RX_START_INT_ST																												
31																			9	8	7	6	5	4	3	2	1	0										
0																			0	0	0	0	0	0	0	0	0	0	0	0	0	0	0	0	0	0	0	Reset

- UHCI_RX_START_INT_ST** The masked interrupt status of UHCI_RX_START_INT. (RO)
- UHCI_TX_START_INT_ST** The masked interrupt status of UHCI_TX_START_INT. (RO)
- UHCI_RX_HUNG_INT_ST** The masked interrupt status of UHCI_RX_HUNG_INT. (RO)
- UHCI_TX_HUNG_INT_ST** The masked interrupt status of UHCI_TX_HUNG_INT. (RO)
- UHCI_SEND_S_REG_Q_INT_ST** The masked interrupt status of UHCI_SEND_S_REG_Q_INT. (RO)
- UHCI_SEND_A_REG_Q_INT_ST** The masked interrupt status of UHCI_SEND_A_REG_Q_INT. (RO)
- UHCI_OUTLINK_EOF_ERR_INT_ST** The masked interrupt status of UHCI_OUTLINK_EOF_ERR_INT. (RO)
- UHCI_APP_CTRL0_INT_ST** The masked interrupt status of UHCI_APP_CTRL0_INT. (RO)
- UHCI_APP_CTRL1_INT_ST** The masked interrupt status of UHCI_APP_CTRL1_INT. (RO)

Register 26.97. UHCI_INT_ENA_REG (0x000C)

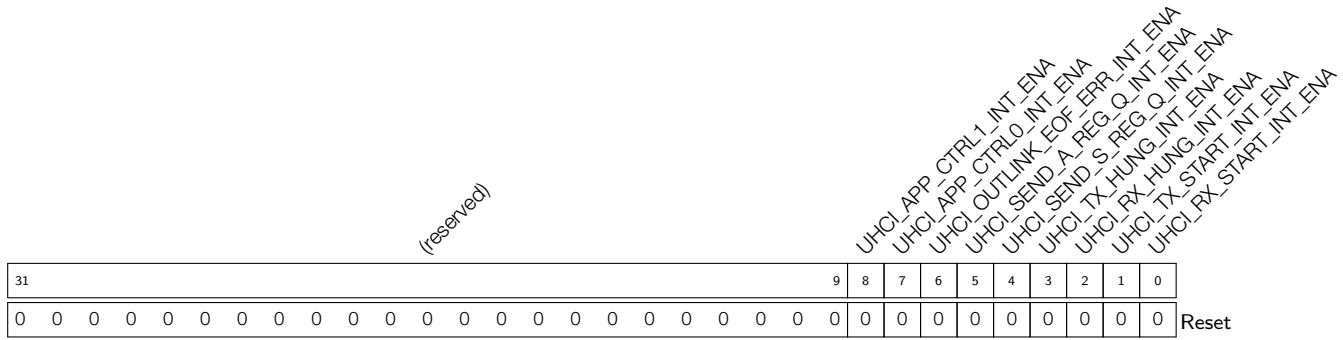

UHCI_RX_START_INT_ENA Write 1 to enable UHCI_RX_START_INT. (R/W)

UHCI_TX_START_INT_ENA Write 1 to enable UHCI_TX_START_INT. (R/W)

UHCI_RX_HUNG_INT_ENA Write 1 to enable UHCI_RX_HUNG_INT. (R/W)

UHCI_TX_HUNG_INT_ENA Write 1 to enable UHCI_TX_HUNG_INT. (R/W)

UHCI_SEND_S_REG_Q_INT_ENA Write 1 to enable UHCI_SEND_S_REG_Q_INT. (R/W)

UHCI_SEND_A_REG_Q_INT_ENA Write 1 to enable UHCI_SEND_A_REG_Q_INT. (R/W)

UHCI_OUTLINK_EOF_ERR_INT_ENA Write 1 to enable UHCI_OUTLINK_EOF_ERR_INT. (R/W)

UHCI_APP_CTRL0_INT_ENA Write 1 to enable UHCI_APP_CTRL0_INT. (R/W)

UHCI_APP_CTRL1_INT_ENA Write 1 to enable UHCI_APP_CTRL1_INT. (R/W)

Register 26.98. UHCI_INT_CLR_REG (0x0010)

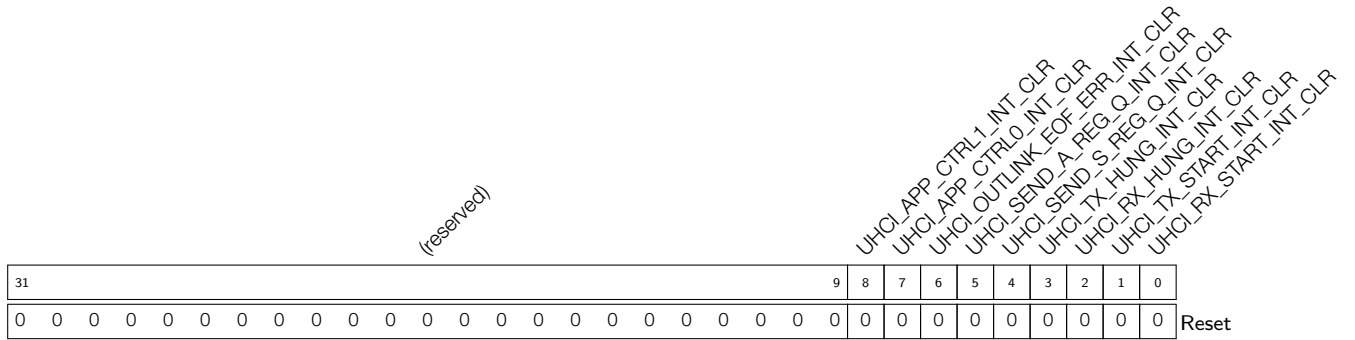

- UHCI_RX_START_INT_CLR** Write 1 to clear UHCI_RX_START_INT. (WT)
- UHCI_TX_START_INT_CLR** Write 1 to clear UHCI_TX_START_INT. (WT)
- UHCI_RX_HUNG_INT_CLR** Write 1 to clear UHCI_RX_HUNG_INT. (WT)
- UHCI_TX_HUNG_INT_CLR** Write 1 to clear UHCI_TX_HUNG_INT. (WT)
- UHCI_SEND_S_REG_Q_INT_CLR** Write 1 to clear UHCI_SEND_S_REG_Q_INT. (WT)
- UHCI_SEND_A_REG_Q_INT_CLR** Write 1 to clear UHCI_SEND_A_REG_Q_INT. (WT)
- UHCI_OUTLINK_EOF_ERR_INT_CLR** Write 1 to clear UHCI_OUTLINK_EOF_ERR_INT. (WT)
- UHCI_APP_CTRL0_INT_CLR** Write 1 to clear UHCI_APP_CTRL0_INT. (WT)
- UHCI_APP_CTRL1_INT_CLR** Write 1 to clear UHCI_APP_CTRL1_INT. (WT)

Register 26.99. UHCI_STATE0_REG (0x0018)

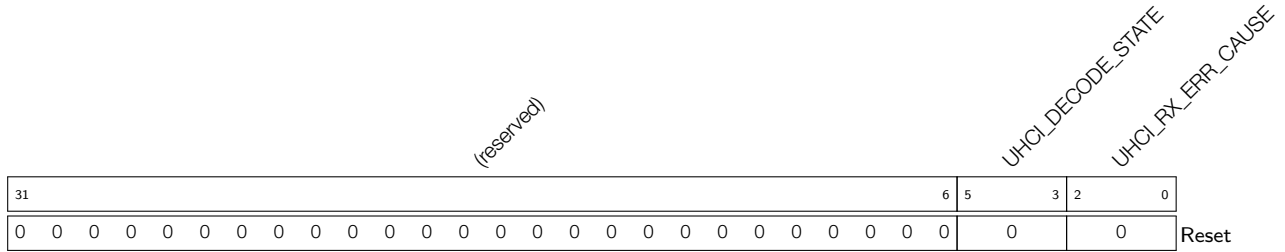

UHCI_RX_ERR_CAUSE Represents the error type when DMA has received a packet with error.

- 0: Invalid. No effect
 - 1: Checksum error in the HCI packet
 - 2: Sequence number error in the HCI packet
 - 3: CRC bit error in the HCI packet
 - 4: 0xC0 is found but the received HCI packet is not complete
 - 5: 0xC0 is not found when the HCI packet has been received
 - 6: CRC check error
 - 7: Invalid. No effect
- (RO)

UHCI_DECODE_STATE Represents the UHCI decoder status. (RO)

Register 26.100. UHCI_STATE1_REG (0x001C)

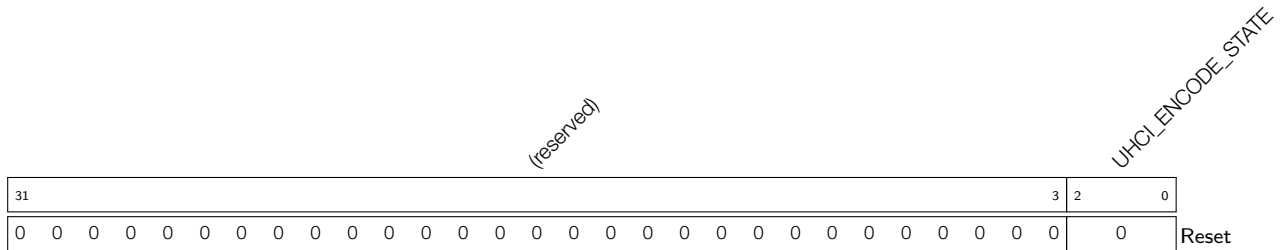

UHCI_ENCODE_STATE Represents the UHCI encoder status. (RO)

Register 26.101. UHCI_RX_HEAD_REG (0x002C)

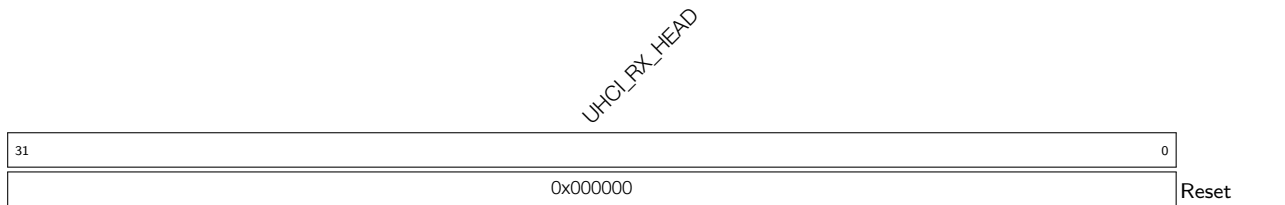

UHCI_RX_HEAD Represents the header of the current received packet. (RO)

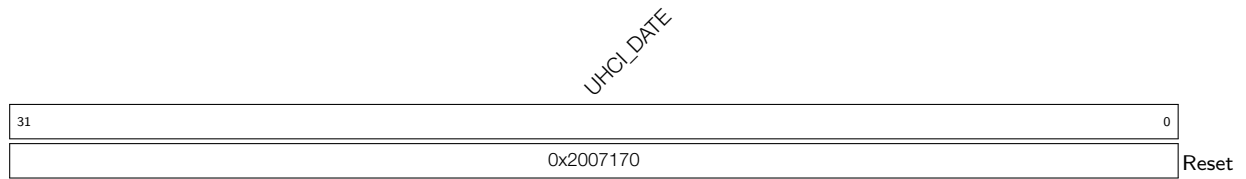
Register 26.102. UHCI_DATE_REG (0x0080)

UHCI_DATE Version control register. (R/W)

27 SPI Controller (SPI)

27.1 Overview

The Serial Peripheral Interface (SPI) is a synchronous serial interface useful for communication with external peripherals. The ESP32-C6 chip integrates three SPI controllers:

- SPI0,
- SPI1,
- and General Purpose SPI2 (GP-SPI2).

SPI0 and SPI1 controllers (MSPI) are primarily reserved for internal use to communicate with external flash and PSRAM memory. This chapter mainly focuses on the GP-SPI2 controller.

27.2 Glossary

To better illustrate the functions of GP-SPI2, the following terms are used in this chapter.

Master Mode	GP-SPI2 acts as an SPI master and initiates SPI transactions.
Slave Mode	GP-SPI2 acts as an SPI slave and exchanges data with its master when its CS is asserted.
MISO	Master in, slave out, data transmission from a slave to a master.
MOSI	Master out, slave in, data transmission from a master to a slave
Transaction	One instance of a master asserting a CS line, transferring data to and from a slave, and de-asserting the CS line. Transactions are atomic, which means they can never be interrupted by another transaction.
SPI Transfer	The whole process of an SPI master exchanging data with a slave. One SPI transfer consists of one or more SPI transactions.
Single Transfer	An SPI transfer that consists of only one transaction.
CPU-Controlled Transfer	A data transfer that happens between CPU buffer SPI_W0_REG ~ SPI_W15_REG and SPI peripheral.
DMA-Controlled Transfer	A data transfer that happens between DMA and SPI peripheral, controlled by the DMA engine.
Configurable Segmented Transfer	A data transfer controlled by DMA in SPI master mode. Such transfer consists of multiple transactions (segments), and each transaction can be configured independently.
Slave Segmented Transfer	A data transfer controlled by DMA in SPI slave mode. Such transfer consists of multiple transactions (segments).
Full-duplex	The sending line and receiving line between the master and the slave are independent. Sending data and receiving data happen at the same time.
Half-duplex	Only one side, the master or the slave, sends data, and the other side receives data. Sending data and receiving data can not happen simultaneously on one side.
4-line full-duplex	4-line here means: clock line, CS line, and two data lines. The two data lines can be used to send or receive data simultaneously.

4-line half-duplex	4-line here means: clock line, CS line, and two data lines. The two data lines can not be used simultaneously.
3-line half-duplex	3-line here means: clock line, CS line, and one data line. The data line is used to transmit or receive data.
1-bit SPI	In one clock cycle, one bit can be transferred.
(2-bit) Dual SPI	In one clock cycle, two bits can be transferred.
Dual Output Read	A data mode of Dual SPI. In one clock cycle, one bit of a command, or one bit of an address, or two bits of data can be transferred.
Dual I/O Read	Another data mode of Dual SPI. In one clock cycle, one bit of a command, or two bits of an address, or two bits of data can be transferred.
(4-bit) Quad SPI	In one clock cycle, four bits can be transferred.
Quad Output Read	A data mode of Quad SPI. In one clock cycle, one bit of a command, or one bit of an address, or four bits of data can be transferred.
Quad I/O Read	Another data mode of Quad SPI. In one clock cycle, one bit of a command, or four bits of an address, or four bits of data can be transferred.
QPI	In one clock cycle, four bits of a command, or four bits of an address, or four bits of data can be transferred.
FSPI	Fast SPI. The prefix of the signals for GP-SPI2. FSPI bus signals are routed to GPIO pins via either GPIO matrix or IO MUX.

27.3 Features

Some of the key features of GP-SPI2 are:

- Works as master or as slave
- Half- and full-duplex communications
- CPU- and DMA-controlled transfers
- Various data modes:
 - 1-bit SPI mode
 - 2-bit Dual SPI mode
 - 4-bit Quad SPI mode
 - QPI mode
- Configurable module clock frequency:
 - Master: up to 80 MHz
 - Slave: up to 60 MHz
- Configurable data length:
 - CPU-controlled transfer as master or as slave: 1 ~ 64 B
 - DMA-controlled single transfer as master: 1 ~ 32 KB
 - DMA-controlled configurable segmented transfer as master: data length is unlimited

- DMA-controlled single transfer or segmented transfer as slave: data length is unlimited
- Configurable bit read/write order
- Independent interrupts for CPU-controlled transfer and DMA-controlled transfer
- Configurable clock polarity and phase
- Four SPI clock modes: mode 0 ~ mode 3
- Six CS lines as master: CS0 ~ CS5
- Able to communicate with SPI devices, such as a sensor, a screen controller, as well as a flash or RAM chip

27.4 Architectural Overview

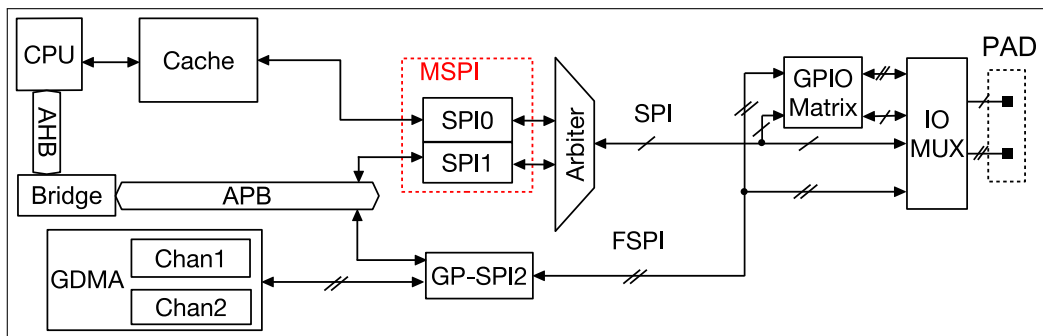

Figure 27-1. SPI Module Overview

Figure 27-1 shows an overview of SPI module. GP-SPI2 exchanges data with SPI devices by the following ways:

- CPU-controlled transfer: CPU <-> GP-SPI2 <-> SPI devices
- DMA-controlled transfer: GDMA <-> GP-SPI2 <-> SPI devices

The signals for GP-SPI2 are prefixed with “FSPI” (Fast SPI). FSPI bus signals are routed to GPIO pins via either GPIO matrix or IO MUX. For more information, see Chapter 7 *IO MUX and GPIO Matrix (GPIO, IO MUX)*.

27.5 Functional Description

27.5.1 Data Modes

GP-SPI2 can be configured as either a master or a slave to communicate with other SPI devices in the following data modes. See Table 27-2.

Table 27-2. Data Modes Supported by GP-SPI2

Supported Mode		CMD State	Address State	Data State
1-bit SPI		1-bit	1-bit	1-bit
Dual SPI	Dual Output Read	1-bit	1-bit	2-bit
	Dual I/O Read	1-bit	2-bit	2-bit
Quad SPI	Quad Output Read	1-bit	1-bit	4-bit
	Quad I/O Read	1-bit	4-bit	4-bit
QPI		4-bit	4-bit	4-bit

For more information about the data modes used when GP-SPI2 works as a master or a slave, see Section [27.5.8](#) and Section [27.5.9](#), respectively.

27.5.2 Introduction to FSPI Bus Signals

The functional description of FSPI bus signals is shown in Table [27-3](#). Table [27-4](#) lists the signals used in various SPI modes.

Table 27-3. Functional Description of FSPI Bus Signals

FSPI Bus Signal	Function
FSPID	MOSI/SIO0 (serial data input and output, bit0)
FSPIQ	MISO/SIO1 (serial data input and output, bit1)
FSPIWP	SIO2 (serial data input and output, bit2)
FSPiHD	SIO3 (serial data input and output, bit3)
FSPICLK	Input and output clock as master/slave
FSPICS0	Input and output CS signal as master/slave
FSPICS1 ~ 5	Output CS signal as master

Table 27-4. Signals Used in Various SPI Modes

FSPI Signal	Master						Slave					
	1-bit SPI			2-bit Dual SPI	4-bit Quad SPI	QPI	1-bit SPI			2-bit Dual SPI	4-bit Quad SPI	QPI
	FD ¹	3-line HD ²	4-line HD				FD	3-line HD	4-line HD			
FSPICLK	Y	Y	Y	Y	Y	Y	Y	Y	Y	Y	Y	Y
FSPICS0	Y	Y	Y	Y	Y	Y	Y	Y	Y	Y	Y	Y
FSPICS1	Y	Y	Y	Y	Y	Y						
FSPICS2	Y	Y	Y	Y	Y	Y						
FSPICS3	Y	Y	Y	Y	Y	Y						
FSPICS4	Y	Y	Y	Y	Y	Y						
FSPICS5	Y	Y	Y	Y	Y	Y						
FSPID	Y	Y	(Y) ³	Y ⁴	Y ⁵	Y	Y	Y	(Y) ⁶	Y ⁷	Y ⁸	Y
FSPIQ	Y		(Y) ³	Y ⁴	Y ⁵	Y	Y		(Y) ⁶	Y ⁷	Y ⁸	Y
FSPiWP					Y ⁵	Y					Y ⁸	Y
FSPiHD					Y ⁵	Y					Y ⁸	Y

¹ FD: full-duplex

² HD: half-duplex

³ Only one of the two signals is used at a time.

⁴ The two signals are used in parallel.

⁵ The four signals are used in parallel.

⁶ Only one of the two signals is used at a time.

⁷ The two signals are used in parallel.

⁸ The four signals are used in parallel.

27.5.3 Bit Read/Write Order Control

When operating as master:

- The bit order of the command, address, and data sent by the GP-SPI2 master is controlled by [SPI_WR_BIT_ORDER](#).
- The bit order of the data received by the master is controlled by [SPI_RD_BIT_ORDER](#).

When operating as slave:

- The bit order of the data sent by the GP-SPI2 slave is controlled by [SPI_WR_BIT_ORDER](#).
- The bit order of the command, address, and data received by the slave is controlled by [SPI_RD_BIT_ORDER](#).

Table [27-5](#) shows the function of [SPI_RD/WR_BIT_ORDER](#).

Table 27-5. Bit Order Control in GP-SPI2

Bit Mode	FSPI Bus Data	SPI_RD/WR_BIT_ORDER = 0 (MSB)	SPI_RD/WR_BIT_ORDER = 2 (MSB)	SPI_RD/WR_BIT_ORDER = 1 (LSB)	SPI_RD/WR_BIT_ORDER = 3 (LSB)
1-bit mode	FSPID or FSPIQ	B7->B6->B5->B4->B3->B2->B1->B0	B7->B6->B5->B4->B3->B2->B1->B0	B0->B1->B2->B3->B4->B5->B6->B7	B0->B1->B2->B3->B4->B5->B6->B7
2-bit mode	FSPIQ	B7->B5->B3->B1	B6->B4->B2->B0	B1->B3->B5->B7	B0->B2->B4->B6
	FSPID	B6->B4->B2->B0	B7->B5->B3->B1	B0->B2->B4->B6	B1->B3->B5->B7
4-bit mode	FSPIHD	B7->B3	B4->B0	B3->B7	B0->B4
	FSPIWP	B6->B2	B5->B1	B2->B6	B1->B5
	FSPIQ	B5->B1	B6->B2	B1->B5	B2->B6
	FSPID	B4->B0	B7->B3	B0->B4	B3->B7

27.5.4 Transfer Types

The transfer types supported by GP-SPI2 when working as a master or a slave are shown on Table 27-6.

Table 27-6. Supported Transfer Types as Master or Slave

Mode		CPU- Controlled Single Transfer	DMA- Controlled Single Transfer	DMA-Controlled Configurable Segmented Transfer	DMA-Controlled Slave Segmented Transfer
Master	Full-Duplex	Y	Y	Y	–
	Half-Duplex	Y	Y	Y	–
Slave	Full-Duplex	Y	Y	–	Y
	Half-Duplex	Y	Y	–	Y

The following sections provide detailed information about the transfer types listed in the table above.

27.5.5 CPU-Controlled Data Transfer

GP-SPI2 provides 16 x 32-bit data buffers, i.e., `SPI_W0_REG` ~ `SPI_W15_REG`, as shown in Figure 27-2.

CPU-controlled transfer indicates the transfer in which the data to send is from GP-SPI2 data buffer and the received data is stored to GP-SPI2 data buffer. In such transfer, every single transaction needs to be triggered by the CPU after its related registers are configured. For such reason, the CPU-controlled transfer is always single transfer (consisting of only one transaction). CPU-controlled transfer supports full-duplex communication and half-duplex communication.

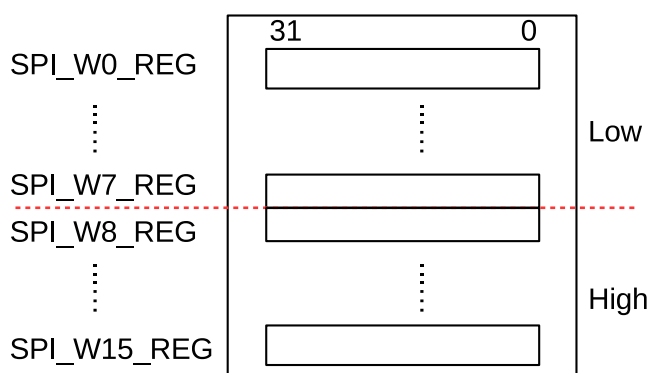

Figure 27-2. Data Buffer Used in CPU-Controlled Transfer

27.5.5.1 CPU-Controlled Master Transfer

In a CPU-controlled master full-duplex or half-duplex transfer, the RX or TX data is saved to or sent from `SPI_W0_REG` ~ `SPI_W15_REG`. The bits `SPI_USR_MOSI_HIGHPART` and `SPI_USR_MISO_HIGHPART` control which buffers are used. See the list below.

- TX data
 - When `SPI_USR_MOSI_HIGHPART` is cleared, i.e., high part mode is disabled, TX data is read from `SPI_W0_REG` ~ `SPI_W15_REG` and the data address is incremented by 1 on each byte transferred. **If the data byte length is larger than 64, the data in `SPI_W0_REG` ~ `SPI_W15_REG` may be sent more than once.** Take each 256 bytes as a cycle:

- * The first 64 bytes (*Byte 0 ~ Byte 63*) are read from [SPI_W0_REG](#) ~ [SPI_W15_REG](#), respectively.
- * *Byte 64 ~ Byte 255* are read from [SPI_W15_REG](#)[31:24] repeatedly.
- * *Byte 256 ~ Byte 319* (the first 64 bytes in the another 256 bytes) are read from [SPI_W0_REG](#) ~ [SPI_W15_REG](#) again, respectively, same as the behaviors described above.

For instance: to send 258 bytes (*Byte 0 ~ Byte 257*), the data is read from the registers as follows:

- * The first 64 bytes (*Byte 0 ~ Byte 63*) are read from [SPI_W0_REG](#) ~ [SPI_W15_REG](#), respectively.
- * *Byte 64 ~ Byte 255* are read from [SPI_W15_REG](#)[31:24] repeatedly.
- * The other bytes (*Byte 256* and *Byte 257*) are read from [SPI_W0_REG](#)[7:0] and [SPI_W0_REG](#)[15:8] again, respectively. The logic is:
 - The address to read data for *Byte 256* is the result of $(256 \% 64 = 0)$, i.e., [SPI_W0_REG](#)[7:0].
 - The address to read data for *Byte 257* is the result of $(257 \% 64 = 1)$, i.e., [SPI_W0_REG](#)[15:8].

- When [SPI_USR_MOSI_HIGHPART](#) is set, i.e., high part mode is enabled, TX data is read from [SPI_W8_REG](#) ~ [SPI_W15_REG](#) and the data address is incremented by 1 on each byte transferred. **If the data byte length is larger than 32, the data in [SPI_W8_REG](#) ~ [SPI_W15_REG](#) may be sent more than once.** Take each 256 bytes as a cycle:

- * The first 32 bytes (*Byte 0 ~ Byte 31*) are read from [SPI_W8_REG](#) ~ [SPI_W15_REG](#), respectively.
- * *Byte 32 ~ Byte 255* are read from [SPI_W15_REG](#)[31:24] repeatedly.
- * *Byte 256 ~ Byte 287* (the first 32 bytes in the another 256 bytes) are read from [SPI_W8_REG](#) ~ [SPI_W15_REG](#) again, respectively, same as the behaviors described above.

For instance: to send 258 bytes (*Byte 0 ~ Byte 257*), the data is read from the registers as follows:

- * The first 32 bytes (*Byte 0 ~ Byte 31*) are read from [SPI_W8_REG](#) ~ [SPI_W15_REG](#), respectively.
- * *Byte 32 ~ Byte 255* are read from [SPI_W15_REG](#)[31:24] repeatedly.
- * The other bytes (*Byte 256* and *Byte 257*) are read from [SPI_W8_REG](#)[7:0] and [SPI_W8_REG](#)[15:8] again, respectively. The logic is:
 - The address to read data for *Byte 256* is the result of $(256 \% 32 = 0)$, i.e., [SPI_W8_REG](#)[7:0].
 - The address to read data for *Byte 257* is the result of $(257 \% 32 = 1)$, i.e., [SPI_W8_REG](#)[15:8].

• RX data

- When [SPI_USR_MISO_HIGHPART](#) is cleared, i.e., high part mode is disabled, RX data is saved to [SPI_W0_REG](#) ~ [SPI_W15_REG](#), and the data address is incremented by 1 on each byte transferred. **If the data byte length is larger than 64, the data in [SPI_W0_REG](#) ~ [SPI_W15_REG](#) may be overwritten.** Take each 256 bytes as a cycle:

- * The first 64 bytes (*Byte 0 ~ Byte 63*) are saved to [SPI_W0_REG](#) ~ [SPI_W15_REG](#), respectively.
- * *Byte 64 ~ Byte 255* are saved to [SPI_W15_REG](#)[31:24] repeatedly.
- * *Byte 256 ~ Byte 319* (the first 64 bytes in the another 256 bytes) are saved to [SPI_W0_REG](#) ~ [SPI_W15_REG](#) again, respectively, same as the behaviors described above.

For instance: to receive 258 bytes (*Byte 0 ~ Byte 257*), the data is saved to the registers as follows:

- * The first 64 bytes (*Byte 0 ~ Byte 63*) are saved to [SPI_W0_REG ~ SPI_W15_REG](#), respectively.
- * *Byte 64 ~ Byte 255* are saved to [SPI_W15_REG\[31:24\]](#) repeatedly.
- * The other bytes (*Byte 256 and Byte 257*) are saved to [SPI_W0_REG\[7:0\]](#) and [SPI_W0_REG\[15:8\]](#) again, respectively. The logic is:
 - The address to save *Byte 256* is the result of $(256 \% 64 = 0)$, i.e., [SPI_W0_REG\[7:0\]](#).
 - The address to save *Byte 257* is the result of $(257 \% 64 = 1)$, i.e., [SPI_W0_REG\[15:8\]](#).
- When [SPI_USR_MISO_HIGHPART](#) is set, i.e., high part mode is enabled, the RX data is saved to [SPI_W8_REG ~ SPI_W15_REG](#), and the data address is incremented by 1 on each byte transferred. **If the data byte length is larger than 32, the content of [SPI_W8_REG ~ SPI_W15_REG](#) may be overwritten.** Take each 256 bytes as a cycle:
 - * *Byte 0 ~ Byte 31* are saved to [SPI_W8_REG ~ SPI_W15_REG](#), respectively.
 - * *Byte 32 ~ Byte 255* are saved to [SPI_W15_REG\[31:24\]](#) repeatedly.
 - * *Byte 256 ~ Byte 287* (the first 32 bytes in the another 256 bytes) are saved to [SPI_W8_REG ~ SPI_W15_REG](#) again, respectively.

For instance: to receive 258 bytes (*Byte 0 ~ Byte 257*), the data is saved to the registers as follows:

- * The first 32 bytes (*Byte 0 ~ Byte 31*) are saved to [SPI_W8_REG ~ SPI_W15_REG](#), respectively.
- * *Byte 32 ~ Byte 255* are saved to [SPI_W15_REG\[31:24\]](#) repeatedly.
- * The other bytes (*Byte 256 and Byte 257*) are saved to [SPI_W8_REG\[7:0\]](#) and [SPI_W8_REG\[15:8\]](#) again, respectively. The logic is:
 - The address to save *Byte 256* is the result of $(256 \% 32 = 0)$, i.e., [SPI_W8_REG\[7:0\]](#).
 - The address to save *Byte 257* is the result of $(257 \% 32 = 1)$, i.e., [SPI_W8_REG\[15:8\]](#).

Note:

- TX/RX data address mentioned above both are byte-addressable.
 - If high part mode is disabled, Address 0 stands for [SPI_W0_REG\[7:0\]](#), and Address 1 for [SPI_W0_REG\[15:8\]](#), and so on.
 - If high part mode is enabled, Address 0 stands for [SPI_W8_REG\[7:0\]](#), and Address 1 for [SPI_W8_REG\[15:8\]](#), and so on.
- The largest address points to [SPI_W15_REG\[31:24\]](#).
- To avoid any possible error in TX/RX data, such as TX data being sent more than once or RX data being overwritten, please make sure the registers are configured correctly.

27.5.5.2 CPU-Controlled Slave Transfer

In a CPU-controlled slave full-duplex or half-duplex transfer, the RX data or TX data is saved to or sent from [SPI_W0_REG ~ SPI_W15_REG](#), which are byte-addressable.

- In full-duplex communication, the address of [SPI_W0_REG ~ SPI_W15_REG](#) starts from 0 and is incremented by 1 on each byte transferred. If the data address is larger than 63, the data in [SPI_W0_REG](#)

~ [SPI_W15_REG](#) will be overwritten, same as the behaviors described in the master mode when high part mode is disabled.

- In half-duplex communication, the *ADDR* value in [transmission format](#) is the start address of the RX or TX data, corresponding to the registers [SPI_W0_REG](#) ~ [SPI_W15_REG](#). The RX or TX address is incremented by 1 on each byte transferred. If the address is larger than 63 (the highest byte address, i.e., [SPI_W15_REG\[31:24\]](#)), the data in [SPI_W8_REG](#) ~ [SPI_W15_REG](#) will be overwritten, same as the behaviors described in the master mode when high part mode is enabled.

According to your applications, the registers [SPI_W0_REG](#) ~ [SPI_W15_REG](#) can be used as:

- data buffers only
- data buffers and status buffers
- status buffers only

27.5.6 DMA-Controlled Data Transfer

DMA-controlled transfer refers to the transfer in which the GDMA RX module receives data and the GDMA TX module sends data. This transfer is supported both as master and as slave.

A DMA-controlled transfer can be:

- a single transfer, consisting of only one transaction. GP-SPI2 supports this transfer both as master and as slave.
- a configurable segmented transfer, consisting of several transactions (segments). GP-SPI2 supports this transfer only as master. For more information, see Section [27.5.8.5](#).
- a slave segmented transfer, consisting of several transactions (segments). GP-SPI2 supports this transfer only as slave. For more information, see Section [27.5.9.3](#).

A DMA-controlled transfer only needs to be triggered once by CPU. When such a transfer is triggered, data is transferred by the GDMA engine from or to the DMA-linked memory, without CPU operation.

DMA-controlled transfer supports full-duplex communication, half-duplex communication and functions described in Section [27.5.8](#) and Section [27.5.9](#). Meanwhile, the GDMA RX module is independent from the GDMA TX module, which means that there are four kinds of full-duplex communications:

- Data is received in DMA-controlled mode and sent in DMA-controlled mode.
- Data is received in DMA-controlled mode but sent in CPU-controlled mode.
- Data is received in CPU-controlled mode but sent in DMA-controlled mode.
- Data is received in CPU-controlled mode and sent in CPU-controlled mode.

27.5.6.1 GDMA Configuration

- Select a GDMA channel *n*, and configure a GDMA TX/RX descriptor. See Chapter [4 GDMA Controller \(GDMA\)](#).
- Set the bit [GDMA_INLINK_START_CHn](#) or [GDMA_OUTLINK_START_CHn](#) to start GDMA RX engine and TX engine, respectively.

- Before all the GDMA TX buffer is used or the GDMA TX engine is reset, if [GDMA_OUTLINK_RESTART_CHn](#) is set, a new TX buffer will be added to the end of the last TX buffer in use.
- GDMA RX buffer is linked in the same way as the GDMA TX buffer, by setting [GDMA_INLINK_START_CHn](#) or [GDMA_INLINK_RESTART_CHn](#).
- The TX and RX data lengths are determined by the configured GDMA TX and RX buffer respectively, both of which are 0 ~ 32 KB.
- Initialize GDMA inlink and outlink before GDMA starts. The bits [SPI_DMA_RX_ENA](#) and [SPI_DMA_TX_ENA](#) in register [SPI_DMA_CONF_REG](#) should be set, otherwise the read/write data will be stored to/sent from the registers [SPI_W0_REG](#) ~ [SPI_W15_REG](#).

When operating as master, if [GDMA_IN_SUC_EOF_CHn_INT_ENA](#) is set, then the interrupt [GDMA_IN_SUC_EOF_CHn_INT](#) will be triggered when one single transfer or one configurable segmented transfer is finished.

When operating as slave, if [GDMA_IN_SUC_EOF_CHn_INT_ENA](#) is set, then the interrupt [GDMA_IN_SUC_EOF_CHn_INT](#) will be triggered when one of the following conditions are met.

Table 27-7. Interrupt Trigger Condition on GP-SPI2 Data Transfer as Slave

Transfer Type	Control Bit ¹	Control Bit ²	Condition
Slave Single Transfer	0	0	A single transfer is done.
	1	0	A single transfer is done. Or the length of the received data is equal to (SPI_MS_DATA_BITLEN + 1)
Slave Segmented Transfer	0	1	(CMD7 or End_SEG_TRANS) is received correctly.
	1	1	(CMD7 or End_SEG_TRANS) is received correctly. Or the length of the received data is equal to (SPI_MS_DATA_BITLEN + 1)

¹ [SPI_RX_EOF_EN](#)

² [SPI_DMA_SLV_SEG_TRANS_EN](#)

27.5.6.2 GDMA TX/RX Buffer Length Control

It is recommended that the length of configured GDMA TX/RX buffer is equal to the length of actual data transferred.

- If the length of configured GDMA TX buffer is shorter than that of actual data transferred, the extra data will be the same as the last transferred data. [SPI_OUTFIFO_EMPTY_ERR_INT](#) and [GDMA_OUT_EOF_CHn_INT](#) are triggered.
- If the length of configured GDMA TX buffer is longer than that of actual data transferred, the TX buffer is not fully used, and the remaining buffer will be used for following transaction even if a new TX buffer is linked later. Please keep it in mind. Or save the unused data and reset DMA.
- If the length of configured GDMA RX buffer is shorter than that of actual data transferred, the extra data will be lost. The interrupts [SPI_INFIFO_FULL_ERR_INT](#) and [SPI_TRANS_DONE_INT](#) are triggered. But [GDMA_IN_SUC_EOF_CHn_INT](#) interrupt is not generated.
- If the length of configured GDMA RX buffer is longer than that of actual data transferred, the RX buffer is not fully used, and the remaining buffer is discarded. In the following transaction, a new linked buffer will be

used directly.

27.5.7 Data Flow Control

CPU-controlled and DMA-controlled transfers are supported in GP-SPI2 both as master and as slave. CPU-controlled transfer means that data is transferred between registers `SPI_W0_REG ~ SPI_W15_REG` and the SPI device. DMA-controlled transfer means that data is transferred between the configured GDMA TX/RX buffer and the SPI device. To select between the two transfer modes, configure `SPI_DMA_RX_ENA` and `SPI_DMA_TX_ENA` before the transfer starts.

27.5.7.1 GP-SPI2 Functional Blocks

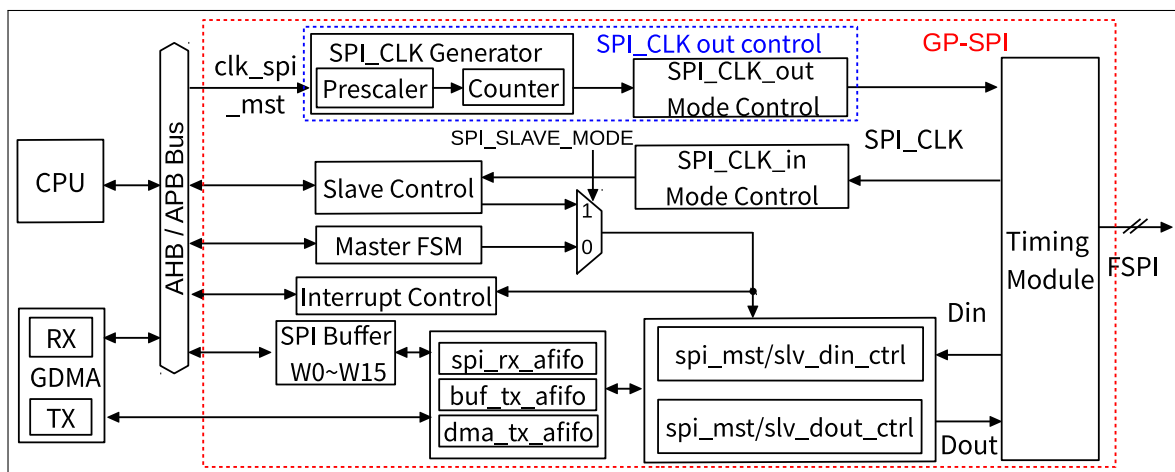

Figure 27-3. GP-SPI2 Block Diagram

Figure 27-3 shows the main functional blocks in GP-SPI2, including:

- **Master FSM:** all the features supported in GP-SPI2 as master are controlled by this state machine together with register configuration.
- **SPI Buffer:** `SPI_W0_REG ~ SPI_W15_REG`. See Figure 27-2. The data transferred in CPU-controlled mode is prepared in this buffer.
- **Timing Module:** captures data on FSPI bus.
- `spi_mst/slv_din_ctrl` and `spi_mst/slv_dout_ctrl`: converts the TX/RX data into bytes.
- `spi_rx_afifo`: stores the received data.
- `buf_tx_afifo`: stores the data to send.
- `dma_tx_afifo`: stores the data from GDMA.
- `clk_spi_mst`: this clock is the module clock of GP-SPI2 and derived from PLL_CLK. It is used in GP-SPI2 as master to generate SPI_CLK signal for data transfer and for slaves.
- **SPI_CLK Generator:** generates SPI_CLK by dividing `clk_spi_mst`. The divider is determined by `SPI_CLKCNT_N` and `SPI_CLKDIV_PRE`. See Section 27.7.
- **SPI_CLK_out Mode Control:** outputs the SPI_CLK signal for data transfer and for slaves.
- **SPI_CLK_in Mode Control:** captures the SPI_CLK signal from SPI master when GP-SPI2 works as a slave.

PRELIMINARY

27.5.7.2 Data Flow Control as Master

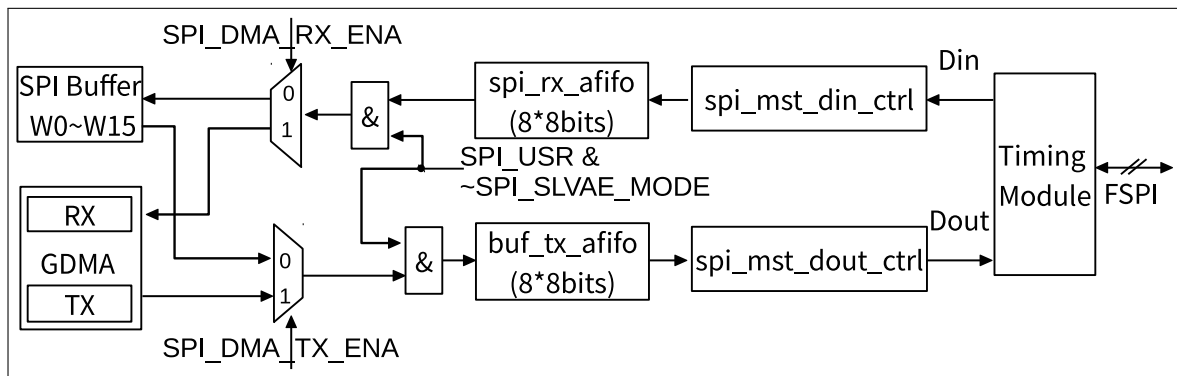

Figure 27-4. Data Flow Control in GP-SPI2 as Master

Figure 27-4 shows the data flow of GP-SPI2 as master. Its control logic is as follows:

- RX data: data in FSPI bus is captured by Timing Module, converted in units of bytes by *spi_mst_din_ctrl* module, then buffered in *spi_rx_afifo*, and finally stored in corresponding addresses according to the transfer modes.
 - CPU-controlled transfer: the data is stored to registers *SPI_W0_REG ~ SPI_W15_REG*.
 - DMA-controlled transfer: the data is stored to GDMA RX buffer.
- TX data: the TX data is from corresponding addresses according to transfer modes and is saved to *buf_tx_afifo*.
 - CPU-controlled transfer: TX data is from *SPI_W0_REG ~ SPI_W15_REG*.
 - DMA-controlled transfer: TX data is from GDMA TX buffer.

The data in *buf_tx_afifo* is sent out to Timing Module in 1/2/4-bit modes, controlled by GP-SPI2 state machine.

The Timing Module can be used for timing compensation. For more information, see Section 27.8.

27.5.7.3 Data Flow Control as Slave

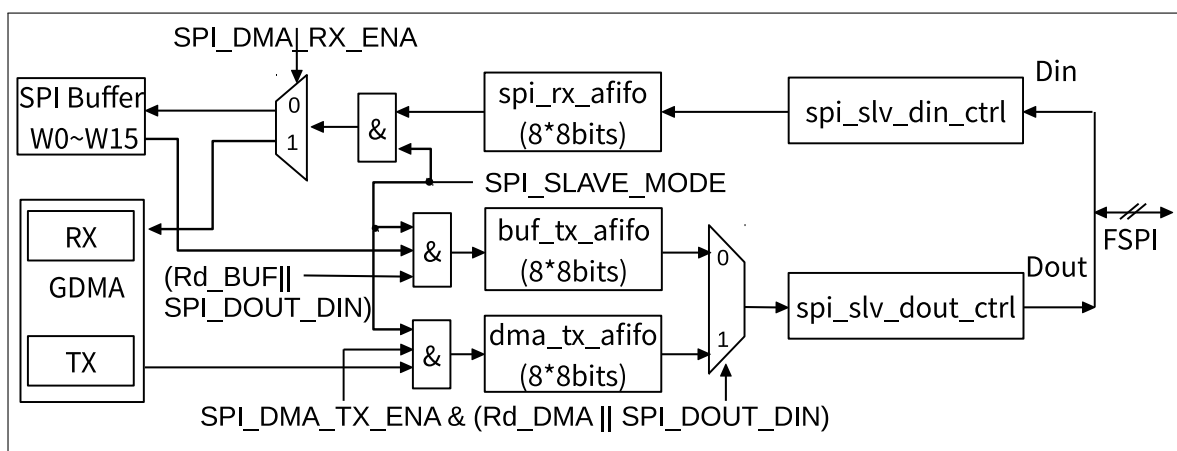

Figure 27-5. Data Flow Control in GP-SPI2 as Slave

Figure 27-5 shows the data flow in GP-SPI2 as slave. Its control logic is as follows:

- In CPU/DMA-controlled full-/half-duplex transfer, when an external SPI master starts the SPI transfer, data on the FSPI bus is captured, converted into unit of bytes by the *spl_slv_din_ctrl* module, and then is stored in *spl_rx_affio*.
 - In CPU-controlled full-duplex transfer, the received data in *spl_rx_affio* will be later stored into registers *SPI_W0_REG* ~ *SPI_W15_REG*, successively.
 - In half-duplex *Wr_BUF* transfer, when the value of address (*SLV_ADDR[7:0]*) is received, the received data in *spl_rx_affio* will be stored in the related address of registers *SPI_W0_REG* ~ *SPI_W15_REG*
 - In DMA-controlled full-duplex transfer or in half-duplex *Wr_DMA* transfer, the received data in *spl_rx_affio* will be stored in the configured GDMA RX buffer.
- In CPU-controlled full-/half-duplex transfer, the data to send is stored in *buf_tx_affio*. In DMA-controlled full-/half-duplex transfer, the data to send is stored in *dma_tx_affio*. Therefore, *Rd_BUF* transaction controlled by CPU and *Rd_DMA* transaction controlled by DMA can be done in one slave segmented transfer. TX data comes from corresponding addresses according the transfer modes.
 - In CPU-controlled full-duplex transfer, when *SPI_SLAVE_MODE* and *SPI_DOUTDIN* are set and *SPI_DMA_TX_ENA* is cleared, the data in *SPI_W0_REG* ~ *SPI_W15_REG* will be stored into *buf_tx_affio*;
 - In CPU-controlled half-duplex transfer, when *SPI_SLAVE_MODE* is set, *SPI_DOUTDIN* is cleared, *Rd_BUF* command and *SLV_ADDR[7:0]* are received, the data started from the related address of *SPI_W0_REG* ~ *SPI_W15_REG* will be stored into *buf_tx_affio*;
 - In DMA-controlled full-duplex transfer, when *SPI_SLAVE_MODE*, *SPI_DOUTDIN* and *SPI_DMA_TX_ENA* are set, the data in the configured GDMA TX buffer will be stored into *dma_tx_affio*;
 - In DMA-controlled half-duplex transfer, when *SPI_SLAVE_MODE* is set, *SPI_DOUTDIN* is cleared, and *Rd_DMA* command is received, the data in the configured GDMA TX buffer will be stored into *dma_tx_affio*.

The data in *buf_tx_affio* or *dma_tx_affio* is sent out by *spl_slv_dout_ctrl* module in 1/2/4-bit modes.

27.5.8 GP-SPI2 as a Master

GP-SPI2 can be configured as a SPI master by clearing the bit *SPI_SLAVE_MODE* in *SPI_SLAVE_REG*. In this operation mode, GP-SPI2 provides clock signal (the divided clock from GP-SPI2 module clock) and six CS lines (*CS0* ~ *CS5*).

Note:

- The length of transferred data must be an integral multiple of byte (8 bits), otherwise the extra bits will be lost. The extra bits here means the result of total data bits mod 8.
- To transfer bits that is not an integral multiple of byte (8 bits), consider implementing it in CMD state or ADDR state.

27.5.8.1 State Machine

When GP-SPI2 works as a master, the state machine controls its various states during data transfer, including configuration (CONF), preparation (PREP), command (CMD), address (ADDR), dummy (DUMMY), data out (DOUT), and data in (DIN) states. GP-SPI2 is mainly used to access 1/2/4-bit SPI devices, such as flash and external RAM, thus the naming of GP-SPI2 states keeps consistent with the sequence naming of flash and external RAM. The meaning of each state is described as follows and Figure 27-6 shows the workflow of GP-SPI2 state machine.

1. IDLE: GP-SPI2 is not active or is operating as slave.
2. CONF: only used in DMA-controlled [configurable segmented transfer](#). Set [SPI_USR](#) and [SPI_USR_CONF](#) to enable this state. If this state is not enabled, it means the current transfer is a single transfer.
3. PREP: prepare an SPI transaction and control SPI CS setup time. Set [SPI_USR](#) and [SPI_CS_SETUP](#) to enable this state.
4. CMD: send command sequence. Set [SPI_USR](#) and [SPI_USR_COMMAND](#) to enable this state.
5. ADDR: send address sequence. Set [SPI_USR](#) and [SPI_USR_ADDR](#) to enable this state.
6. DUMMY (wait cycle): send dummy sequence. Set [SPI_USR](#) and [SPI_USR_DUMMY](#) to enable this state.
7. DATA: transfer data.
 - DOUT: send data sequence. Set [SPI_USR](#) and [SPI_USR_MOSI](#) to enable this state.
 - DIN: receive data sequence. Set [SPI_USR](#) and [SPI_USR_MISO](#) to enable this state.
8. DONE: control SPI CS hold time. Set [SPI_USR](#) to enable this state.

Note:

To start this state machine, set [SPI_USR](#) first. [SPI_MST_FD_WAIT_DMA_TX_DATA](#) controls when [SPI_USR](#) takes effect:

- 0: the configured state takes effect immediately after [SPI_USR](#) and other control registers are configured.
- 1: if DOUT state is configured, the [SPI_USR](#) and other control registers will take effect, and the state machine will start, only when the data is ready in *buf_tx_fifo*.

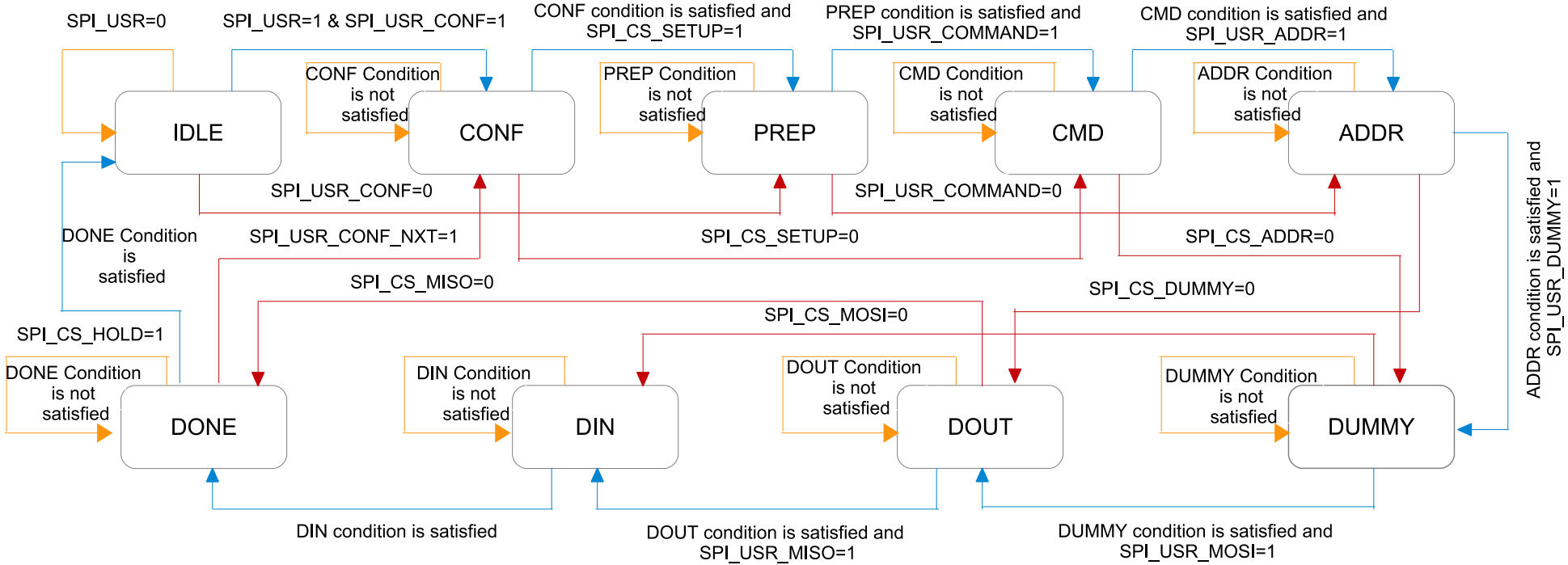

Figure 27-6. GP-SPI2 State Machine as Master

Legend to state flow:

- —: corresponding state condition is not satisfied; repeats current state.
- —: corresponding registers are set and conditions are satisfied; goes to next state.
- —: state registers are not set; skips one or more following states, depending on the registers of the following states are set or not.

Explanation to the conditions listed in the figure above:

- CONF condition: $gpc[17:0] \geq SPI_CONF_BITLEN[17:0]$
- PREP condition: $gpc[4:0] \geq SPI_CS_SETUP_TIME[4:0]$
- CMD condition: $gpc[3:0] \geq SPI_USR_COMMAND_BITLEN[3:0]$
- ADDR condition: $gpc[4:0] \geq SPI_USR_ADDR_BITLEN[4:0]$
- DUMMY condition: $gpc[7:0] \geq SPI_USR_DUMMY_CYCLELEN[7:0]$
- DOUT condition: $gpc[17:0] \geq SPI_MS_DATA_BITLEN[17:0]$
- DIN condition: $gpc[17:0] \geq SPI_MS_DATA_BITLEN[17:0]$
- DONE condition: $(gpc[4:0] \geq SPI_CS_HOLD_TIME[4:0] \parallel SPI_CS_HOLD == 1'b0)$

A counter ($gpc[17:0]$) is used in the state machine to control the cycle length of each state. The states CONF, PREP, CMD, ADDR, DUMMY, DOUT, and DIN can be enabled or disabled independently. The cycle length of each state can also be configured independently.

27.5.8.2 Register Configuration for State and Bit Mode Control

Introduction

The registers, related to GP-SPI2 state control, are listed in Table 27-8. Users can enable QPI mode for GP-SPI2 by setting the bit `SPI_QPI_MODE` in register `SPI_USER_REG`.

Table 27-8. Registers Used for State Control in 1/2/4-bit Modes

State	Control Registers for 1-bit Mode FSPI Bus	Control Registers for 2-bit Mode FSPI Bus	Control Registers for 4-bit Mode FSPI Bus
CMD	<code>SPI_USR_COMMAND_VALUE</code> <code>SPI_USR_COMMAND_BITLEN</code> <code>SPI_USR_COMMAND</code>	<code>SPI_USR_COMMAND_VALUE</code> <code>SPI_USR_COMMAND_BITLEN</code> <code>SPI_FCMD_DUAL</code> <code>SPI_USR_COMMAND</code>	<code>SPI_USR_COMMAND_VALUE</code> <code>SPI_USR_COMMAND_BITLEN</code> <code>SPI_FCMD_QUAD</code> <code>SPI_USR_COMMAND</code>
ADDR	<code>SPI_USR_ADDR_VALUE</code> <code>SPI_USR_ADDR_BITLEN</code> <code>SPI_USR_ADDR</code>	<code>SPI_USR_ADDR_VALUE</code> <code>SPI_USR_ADDR_BITLEN</code> <code>SPI_USR_ADDR</code> <code>SPI_FADDR_DUAL</code>	<code>SPI_USR_ADDR_VALUE</code> <code>SPI_USR_ADDR_BITLEN</code> <code>SPI_USR_ADDR</code> <code>SPI_FADDR_QUAD</code>
DUMMY	<code>SPI_USR_DUMMY_CYCLELEN</code> <code>SPI_USR_DUMMY</code>	<code>SPI_USR_DUMMY_CYCLELEN</code> <code>SPI_USR_DUMMY</code>	<code>SPI_USR_DUMMY_CYCLELEN</code> <code>SPI_USR_DUMMY</code>
DIN	<code>SPI_USR_MISO</code> <code>SPI_MS_DATA_BITLEN</code>	<code>SPI_USR_MISO</code> <code>SPI_MS_DATA_BITLEN</code> <code>SPI_FREAD_DUAL</code>	<code>SPI_USR_MISO</code> <code>SPI_MS_DATA_BITLEN</code> <code>SPI_FREAD_QUAD</code>

Table 27-8. Registers Used for State Control in 1/2/4-bit Modes

State	Control Registers for 1-bit Mode FSPI Bus	Control Registers for 2-bit Mode FSPI Bus	Control Registers for 4-bit Mode FSPI Bus
DOUT	SPI_USR_MOSI SPI_MS_DATA_BITLEN	SPI_USR_MOSI SPI_MS_DATA_BITLEN SPI_FWRITE_DUAL	SPI_USR_MOSI SPI_MS_DATA_BITLEN SPI_FWRITE_QUAD

As shown in Table 27-8, the registers in each cell should be configured to set the FSPI bus to corresponding bit mode, i.e., the mode shown in the table header, at a specific state (corresponding to the first column).

Configuration

For instance, when GP-SPI2 reads data, and

- CMD is in 1-bit mode
- ADDR is in 2-bit mode
- DUMMY is 8 clock cycles
- DIN is in 4-bit mode

The register configuration can be as follows:

1. Configure CMD state related registers.
 - Configure the required command value in [SPI_USR_COMMAND_VALUE](#).
 - Configure command bit length in [SPI_USR_COMMAND_BITLEN](#). [SPI_USR_COMMAND_BITLEN](#) = expected bit length - 1.
 - Set [SPI_USR_COMMAND](#).
 - Clear [SPI_FCMD_DUAL](#) and [SPI_FCMD_QUAD](#).
2. Configure ADDR state related registers.
 - Configure the required address value in [SPI_USR_ADDR_VALUE](#).
 - Configure address bit length in [SPI_USR_ADDR_BITLEN](#). [SPI_USR_ADDR_BITLEN](#) = expected bit length - 1.
 - Set [SPI_USR_ADDR](#) and [SPI_FADDR_DUAL](#).
 - Clear [SPI_FADDR_QUAD](#).
3. Configure DUMMY state related registers.
 - Configure DUMMY cycles in [SPI_USR_DUMMY_CYCLELEN](#). [SPI_USR_DUMMY_CYCLELEN](#) = expected clock cycles - 1.
 - Set [SPI_USR_DUMMY](#).
4. Configure DIN state related registers.
 - Configure read data bit length in [SPI_MS_DATA_BITLEN](#). [SPI_MS_DATA_BITLEN](#) = bit length expected - 1.
 - Set [SPI_FREAD_QUAD](#) and [SPI_USR_MISO](#).

- Clear [SPI_FREAD_DUAL](#).
- Configure GDMA in DMA-controlled mode. In CPU-controlled mode, no action is needed.

5. Clear [SPI_USR_MOSI](#).

6. Set [SPI_DMA_AFIFO_RST](#), [SPI_BUF_AFIFO_RST](#), and [SPI_RX_AFIFO_RST](#) to reset these buffers.

7. Set [SPI_USR](#) to start GP-SPI2 transfer.

When writing data (DOUT state), [SPI_USR_MOSI](#) should be configured instead, while [SPI_USR_MISO](#) should be cleared. The output data bit length is the value of [SPI_MS_DATA_BITLEN](#) + 1. Output data should be configured in GP-SPI2 data buffer ([SPI_W0_REG](#) ~ [SPI_W15_REG](#)) in CPU-controlled mode, or GDMA TX buffer in DMA-controlled mode. The data byte order is incremented from LSB (byte 0) to MSB.

Pay special attention to the command value in [SPI_USR_COMMAND_VALUE](#) and to address value in [SPI_USR_ADDR_VALUE](#).

The configuration of command value is as follows:

Table 27-9. Sending Sequence of Command Value

COMMAND_BITLEN ¹	COMMAND_VALUE ²	BIT_ORDER ³	Sending Sequence of Command Value
0 - 7	[7:0]	1	COMMAND_VALUE [COMMAND_BITLEN :0] is sent first.
		0	COMMAND_VALUE [7:7 - COMMAND_BITLEN] is sent first.
8 - 15	[15:0]	1	COMMAND_VALUE [7:0] is sent first, and then COMMAND_VALUE [COMMAND_BITLEN :8] is sent.
		0	COMMAND_VALUE [7:0] is sent first, and then COMMAND_VALUE [15:15 - COMMAND_BITLEN] is sent.

¹ [SPI_USR_COMMAND_BITLEN](#): this field is used to configure the bit length of the command.

² [SPI_USR_COMMAND_VALUE](#): command value is written into this field. For which part of this field is used, see the table above.

³ [SPI_WR_BIT_ORDER](#): 0: LSB first; 1: MSB first.

The configuration of address value is as follows:

Table 27-10. Sending Sequence of Address Value

ADDR_BITLEN ¹	ADDR_VALUE ²	BIT_ORDER ³	Sending Sequence of Address Value
0 - 7	[31:24]	1	ADDR_VALUE[ADDR_BITLEN + 24:24] is sent first.
		0	ADDR_VALUE[31:31 - ADDR_BITLEN] is sent first.
8 - 15	[31:16]	1	ADDR_VALUE[31:24] is sent first, and then ADDR_VALUE[ADDR_BITLEN + 8:16] is sent.
		0	ADDR_VALUE[31:24] is sent first, and then ADDR_VALUE[23:31 - ADDR_BITLEN] is sent.
16 - 23	[31:8]	1	ADDR_VALUE[31:16] is sent first, and then ADDR_VALUE[ADDR_BITLEN - 8:8] is sent.
		0	ADDR_VALUE[31:16] is sent first, and then ADDR_VALUE[15:31 - ADDR_BITLEN] is sent.
24 - 31	[31:0]	1	ADDR_VALUE[31:8] is sent first, and then ADDR_VALUE[ADDR_BITLEN - 24:0] is sent.
		0	ADDR_VALUE[31:8] is sent first, and then ADDR_VALUE[7:31 - ADDR_BITLEN] is sent.

¹ SPI_USR_ADDR_BITLEN: this field is used to configure the bit length of the address.

² SPI_USR_ADDR_VALUE: address value is written into this field. For which part of this field is used, see the table above.

³ SPI_WR_BIT_ORDER: 0: LSB first; 1: MSB first.

27.5.8.3 Full-Duplex Communication (1-bit Mode Only)

Introduction

GP-SPI2 supports SPI full-duplex communication. In this mode, SPI master provides CLK and CS signals, exchanging data with SPI slave in 1-bit mode via MOSI (FSPID, sending) and MISO (FSPIQ, receiving) at the same time. To enable this communication mode, set the bit SPI_DOUTDIN in register SPI_USER_REG. Figure 27-7 illustrates the connection of GP-SPI2 with its slave in full-duplex communication.

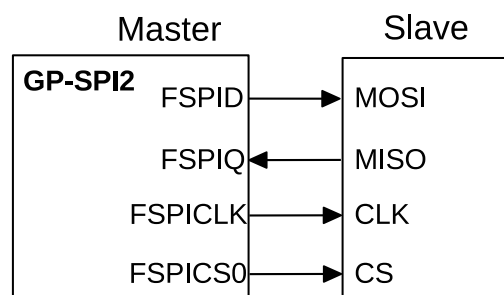

Figure 27-7. Full-Duplex Communication Between GP-SPI2 Master and a Slave

In full-duplex communication, the behavior of states CMD, ADDR, DUMMY, DOUT and DIN are configurable. Usually, the states CMD, ADDR and DUMMY are not used in this communication. The bit length of transferred data is configured in SPI_MS_DATA_BITLEN. The actual bit length used in communication equals to (SPI_MS_DATA_BITLEN + 1).

Configuration

To start a data transfer, follow the steps below:

- Configure the IO path via IO MUX or GPIO matrix between GP-SPI2 and an external SPI device.
- Configure AHB clock (AHB_CLK), APB clock (APB_CLK, see Chapter 8 *Reset and Clock*) and module clock (clk_spi_mst) for the GP-SPI2 module.
- Set `SPI_DOUTDIN` and clear `SPI_SLAVE_MODE`, to enable full-duplex communication as master.
- Configure GP-SPI2 registers listed in Table 27-8.
- Configure SPI CS setup time and hold time according to Section 27.6.
- Set the property of FSPICLK according to Section 27.7.
- Prepare data according to the selected transfer mode:
 - In CPU-controlled MOSI mode, prepare data in registers `SPI_W0_REG` ~ `SPI_W15_REG`.
 - In DMA-controlled mode,
 - * configure `SPI_DMA_TX_ENA/SPI_DMA_RX_ENA`,
 - * configure GDMA TX/RX link,
 - * and start GDMA TX/RX engine, as described in Section 27.5.6 and Section 27.5.7.
- Configure interrupts and wait for SPI slave to get ready for transfer.
- Set `SPI_DMA_AFIFO_RST`, `SPI_BUF_AFIFO_RST`, and `SPI_RX_AFIFO_RST` to reset these buffers.
- Set `SPI_USR` in register `SPI_CMD_REG` to start the transfer and wait for the configured interrupts.

27.5.8.4 Half-Duplex Communication (1/2/4-bit Mode)

Introduction

In this mode, GP-SPI2 provides CLK and CS signals. Only one side (SPI master or slave) can send data at a time, while the other side receives the data. To enable this communication mode, clear the bit `SPI_DOUTDIN` in register `SPI_USER_REG`. The standard format of SPI half-duplex communication is `CMD + [ADDR +] [DUMMY +] [DOUT or DIN]`. The states ADDR, DUMMY, DOUT, and DIN are optional, and can be disabled or enabled independently.

As described in Section 27.5.8.2, the properties of GP-SPI2 states: CMD, ADDR, DUMMY, DOUT and DIN, such as cycle length, value, and parallel bus bit mode, can be set independently. For the register configuration, see Table 27-8.

The detailed properties of half-duplex GP-SPI2 are as follows:

1. CMD: 0 ~ 16 bits, master output, slave input.
2. ADDR: 0 ~ 32 bits, master output, slave input.
3. DUMMY: 0 ~ 256 FSPICLK cycles, master output, slave input.
4. DOUT: 0 ~ 512 bits (64 B) in CPU-controlled mode and 0 ~ 256 Kbits (32 KB) in DMA-controlled mode, master output, slave input.
5. DIN: 0 ~ 512 bits (64 B) in CPU-controlled mode and 0 ~ 256 Kbits (32 KB) in DMA-controlled mode, master input, slave output.

Configuration

The register configuration is as follows:

1. Configure the IO path via IO MUX or GPIO matrix between GP-SPI2 and an external SPI device.
2. Configure AHB clock (AHB_CLK), APB clock (APB_CLK), and module clock (clk_spi_mst) for the GP-SPI2 module.
3. Clear `SPI_DOUTDIN` and `SPI_SLAVE_MODE`, to enable half-duplex communication as master.
4. Configure GP-SPI2 registers listed in Table 27-8.
5. Configure SPI CS setup time and hold time according to Section 27.6.
6. Set the property of FSPICLK according to Section 27.7.
7. Prepare data according to the selected transfer mode:
 - In CPU-controlled MOSI mode, prepare data in registers `SPI_W0_REG` ~ `SPI_W15_REG`.
 - In DMA-controlled mode,
 - configure `SPI_DMA_TX_ENA/SPI_DMA_RX_ENA`,
 - configure GDMA TX/RX link,
 - and start GDMA TX/RX engine, as described in Section 27.5.6 and Section 27.5.7.
8. Configure interrupts and wait for SPI slave to get ready for transfer.
9. Set `SPI_DMA_AFIFO_RST`, `SPI_BUF_AFIFO_RST`, and `SPI_RX_AFIFO_RST` to reset these buffers.
10. Set `SPI_USR` in register `SPI_CMD_REG` to start the transfer and wait for the configured interrupts.

Application Example

The following example shows how GP-SPI2 accesses flash and external RAM in master half-duplex mode.

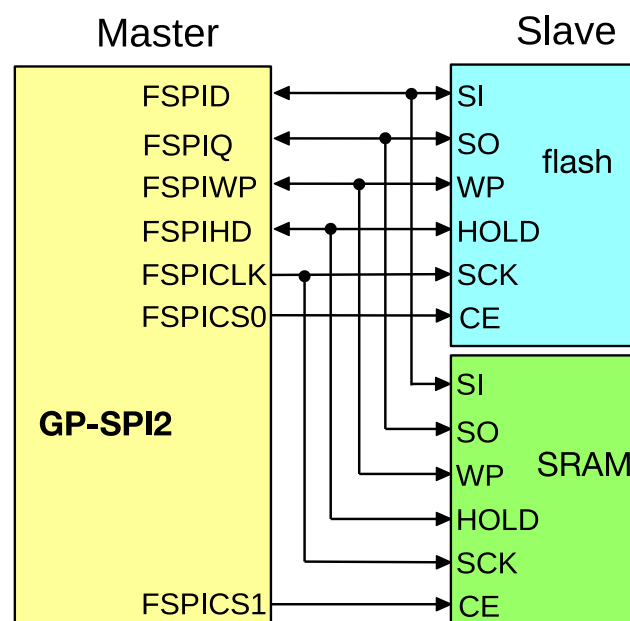

Figure 27-8. Connection of GP-SPI2 to Flash and External RAM in 4-bit Mode

Figure 27-9 indicates GP-SPI2 Quad I/O Read sequence according to standard flash specification. Other GP-SPI2 command sequences are implemented in accordance with the requirements of SPI slaves.

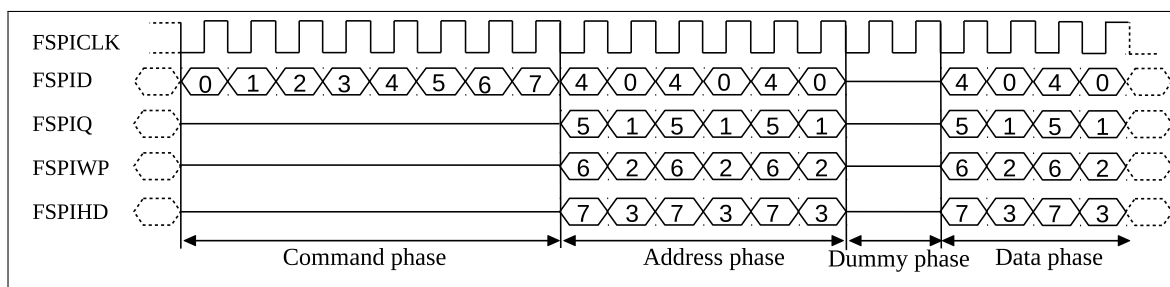

Figure 27-9. SPI Quad I/O Read Command Sequence Sent by GP-SPI2 to Flash

27.5.8.5 DMA-Controlled Configurable Segmented Transfer

Note:

Note that there is no separate section on how to configure a single transfer as master, since the CONF state of a configurable segmented transfer can be skipped to implement a single transfer.

Introduction

When GP-SPI2 works as a master, it provides a feature named configurable segmented transfer controlled by DMA.

A DMA-controlled transfer as master can be

- a single transfer, consisting of only one transaction;
- or a configurable segmented transfer, consisting of several transactions (segments).

In a configurable segmented transfer, the registers of each single transaction (segment) are configurable. This feature enables GP-SPI2 to do as many transactions (segments) as configured after such transfer is triggered once by the CPU. Figure 27-10 shows how this feature works.

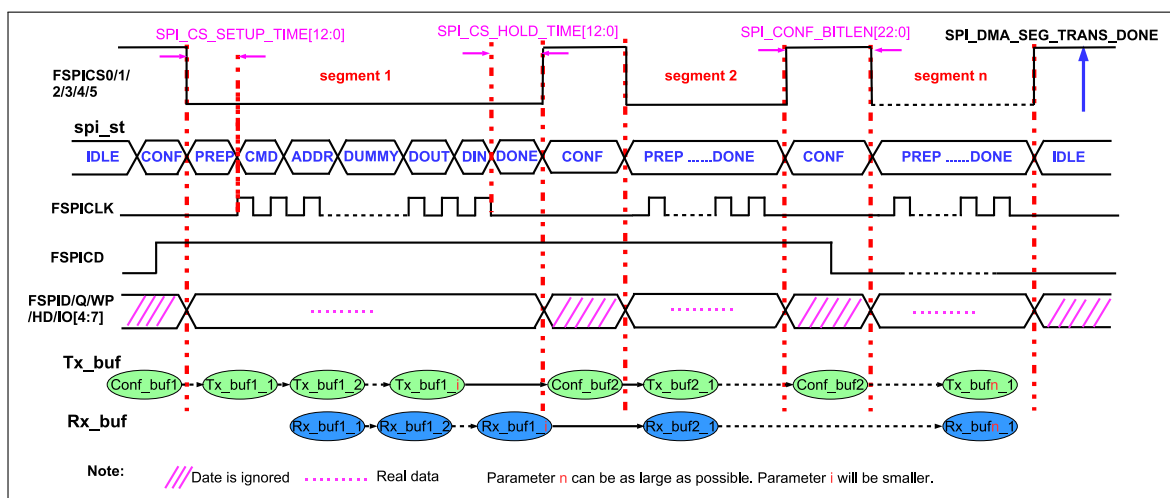

Figure 27-10. Configurable Segmented Transfer as Master

As shown in Figure 27-10, the registers for one transaction (segment *n*) can be reconfigured by GP-SPI2

hardware according to the content in its `Conf_bufn` during a CONF state, before this segment starts.

It's recommended to provide separate GDMA CONF links and CONF buffers (`Conf_bufi` in Figure 27-10) for each CONF state. A GDMA TX link is used to connect all the CONF buffers and TX data buffers (`Tx_bufi` in Figure 27-10) into a chain. Hence, the behavior of the FSPI bus in each segment can be controlled independently.

For example, in a configurable segmentent transfer, its segment*i*, segment*j*, and segment*k* can be configured to full-duplex, half-duplex MISO, and half-duplex MOSI, respectively. *i*, *j*, and *k* represent different segment numbers.

Meanwhile, the state of GP-SPI2, the data length and cycle length of the FSPI bus, and the behavior of the GDMA, can be configured independently for each segment. When this whole DMA-controlled transfer (consisting of several segments) has finished, a GP-SPI2 interrupt, `SPI_DMA_SEG_TRANS_DONE_INT`, is triggered.

Configuration

1. Configure the IO path via IO MUX or GPIO matrix between GP-SPI2 and an external SPI device.
2. Configure AHB clock (`AHB_CLK`), APB clock (`APB_CLK`), and module clock (`clk_spi_mst`) for GP-SPI2 module.
3. Clear `SPI_DOUTDIN` and `SPI_SLAVE_MODE`, to enable half-duplex communication as master.
4. Configure GP-SPI2 registers listed in Table 27-8.
5. Configure SPI CS setup time and hold time according to Section 27.6.
6. Set the property of `FSPICLK` according to Section 27.7.
7. Prepare descriptors for GDMA CONF buffer and TX data (optional) for each segment. Chain the descriptors of CONF buffer and TX buffers of several segments into one linked list.
8. Similarly, prepare descriptors for RX buffers for each segment and chain them into one linked list.
9. Configure all the needed CONF buffers, TX buffers and RX buffers, respectively for each segment before this DMA-controlled transfer begins.
10. Point `GDMA_OUTLINK_ADDR_CHn` to the head address of the CONF and TX buffer descriptor linked list, and then set `GDMA_OUTLINK_START_CHn` to start the TX GDMA.
11. Clear the bit `SPI_RX_EOF_EN` in register `SPI_DMA_CONF_REG`. Point `GDMA_INLINK_ADDR_CHn` to the head address of the RX buffer descriptor linked list, and then set `GDMA_INLINK_START_CHn` to start the RX GDMA.
12. Set `SPI_USR_CONF` to enable CONF state.
13. Set `SPI_DMA_SEG_TRANS_DONE_INT_ENA` to enable the `SPI_DMA_SEG_TRANS_DONE_INT` interrupt. Configure other interrupts if needed according to Section 27.9.
14. Wait for all the slaves to get ready for transfer.
15. Set `SPI_DMA_AFIFO_RST`, `SPI_BUF_AFIFO_RST` and `SPI_RX_AFIFO_RST`, to reset these buffers.
16. Set `SPI_USR` to start this DMA-controlled transfer.
17. Wait for `SPI_DMA_SEG_TRANS_DONE_INT` interrupt, which means this transfer has finished and the data has been stored into corresponding memory.

Configuration of CONF Buffer and Magic Value

In a configurable segmented transfer, only registers which will change from the last transaction (segment) need to be re-configured to new values in CONF state. The configuration of other registers can be skipped (i.e., kept the same) to save time and chip resources.

The first word in GDMA CONF buffer, called SPI_BIT_MAP_WORD, defines whether each GP-SPI2 register is to be updated or not in segment. The relation of SPI_BIT_MAP_WORD and GP-SPI2 registers to update can be seen in Bitmap (BM) Table, Table 27-11. If a bit in the BM table is set to 1, its corresponding register value will be updated in this segment. Otherwise, if some registers should be kept from being changed, the related bits should be set to 0.

Table 27-11. BM Table for CONF State

BM Bit	Register Name	BM Bit	Register Name
0	SPI_ADDR_REG	7	SPI_MISC_REG
1	SPI_CTRL_REG	8	SPI_DIN_MODE_REG
2	SPI_CLOCK_REG	9	SPI_DIN_NUM_REG
3	SPI_USER_REG	10	SPI_DOUT_MODE_REG
4	SPI_USER1_REG	11	SPI_DMA_CONF_REG
5	SPI_USER2_REG	12	SPI_DMA_INT_ENA_REG
6	SPI_MS_DLEN_REG	13	SPI_DMA_INT_CLR_REG

Then new values of all the registers to be modified should be placed right after SPI_BIT_MAP_WORD, in consecutive words in the CONF buffer.

To ensure the correctness of the content in each CONF buffer, the value in SPI_BIT_MAP_WORD[31:28] is used as “magic value”, and will be compared with SPI_DMA_SEG_MAGIC_VALUE in register SPI_SLAVE_REG. The value of SPI_DMA_SEG_MAGIC_VALUE should be configured before this DMA-controlled transfer starts, and can not be changed during these segments.

- If SPI_BIT_MAP_WORD[31:28] == SPI_DMA_SEG_MAGIC_VALUE, this DMA-controlled transfer continues normally; the interrupt SPI_DMA_SEG_TRANS_DONE_INT is triggered at the end of this DMA-controlled transfer.
- If SPI_BIT_MAP_WORD[31:28] != SPI_DMA_SEG_MAGIC_VALUE, GP-SPI2 state (spi_st) goes back to IDLE and the transfer is ended immediately. The interrupt SPI_DMA_SEG_TRANS_DONE_INT is still triggered, with SPI_SEG_MAGIC_ERR_INT_RAW bit set to 1.

CONF Buffer Configuration Example

Table 27-12 and Table 27-13 provide an example to show how to configure a CONF buffer for a transaction (segment) in which SPI_ADDR_REG, SPI_CTRL_REG, SPI_CLOCK_REG, SPI_USER_REG, SPI_USER1_REG need to be updated.

Table 27-12. An Example of CONF bufferⁱ in Segmentⁱ

CONF buffer ⁱ	Note
SPI_BIT_MAP_WORD	The first word in this buffer. Its value is 0xA000001F in this example when the SPI_DMA_SEG_MAGIC_VALUE is set to 0xA. As shown in Table 27-13, bits 0, 1, 2, 3, and 4 are set, indicating the following registers will be updated.
SPI_ADDR_REG	The second word, stores the new value to SPI_ADDR_REG .
SPI_CTRL_REG	The third word, stores the new value to SPI_CTRL_REG .
SPI_CLOCK_REG	The fourth word, stores the new value to SPI_CLOCK_REG .
SPI_USER_REG	The fifth word, stores the new value to SPI_USER_REG .
SPI_USER1_REG	The sixth word, stores the new value to SPI_USER1_REG .

Table 27-13. BM Bit Value v.s. Register to Be Updated in This Example

BM Bit	Value	Register Name	BM Bit	Value	Register Name
0	1	SPI_ADDR_REG	7	0	SPI_MISC_REG
1	1	SPI_CTRL_REG	8	0	SPI_DIN_MODE_REG
2	1	SPI_CLOCK_REG	9	0	SPI_DIN_NUM_REG
3	1	SPI_USER_REG	10	0	SPI_DOUT_MODE_REG
4	1	SPI_USER1_REG	11	0	SPI_DMA_CONF_REG
5	0	SPI_USER2_REG	12	0	SPI_DMA_INT_ENA_REG
6	0	SPI_MS_DLEN_REG	13	0	SPI_DMA_INT_CLR_REG

Notes:

In a DMA-controlled configurable segmented transfer, please pay special attention to the following bits:

- [SPI_USR_CONF](#): set [SPI_USR_CONF](#) before [SPI_USR](#) is set, to enable this transfer.
- [SPI_USR_CONF_NXT](#): if segmentⁱ is not the final transaction of this whole DMA-controlled transfer, its [SPI_USR_CONF_NXT](#) bit should be set to 1.
- [SPI_CONF_BITLEN](#): GP-SPI2 CS setup time and hold time are programmable independently in each segment, see Section 27.6 for detailed configuration. The CS high time in each segment is about:

$$(\text{SPI_CONF_BITLEN} + 5) \times T_{\text{AHB_CLK}}$$

The CS high time in CONF state can be set from 62.5 μs to 3.2768 ms when $f_{\text{AHB_CLK}}$ is 80 MHz.

([SPI_CONF_BITLEN](#) + 5) will overflow from (0x40000 - [SPI_CONF_BITLEN](#) - 5) if [SPI_CONF_BITLEN](#) is larger than 0x3FFFA.

27.5.9 GP-SPI2 Works as a Slave

GP-SPI2 can be used as a slave to communicate with an SPI master. As a slave, GP-SPI2 supports 1-bit SPI, 2-bit dual SPI, 4-bit quad SPI, and QPI modes, with specific communication formats. To enable this mode, set [SPI_SLAVE_MODE](#) in register [SPI_SLAVE_REG](#).

The CS signal must be held low during the transmission, and its falling/rising edges indicate the start/end of a

single or segmented transmission. The length of transferred data must be in unit of bytes, otherwise the extra bits will be lost. The extra bits here means the result of total bits % 8.

27.5.9.1 Communication Formats

In GP-SPI2 as slave, SPI full-duplex and half-duplex communications are available. To select from the two communications, configure [SPI_DOUTDIN](#) in register [SPI_USER_REG](#).

Full-duplex communication means that input data and output data are transmitted simultaneously throughout the entire transaction. All bits are treated as input or output data, which means no command, address or dummy states are expected. The interrupt [SPI_TRANS_DONE_INT](#) is triggered once the transaction ends.

In half-duplex communication, the format is CMD+ADDR+DUMMY+DATA (DIN or DOUT).

- “DIN” means that an SPI master reads data from GP-SPI2.
- “DOUT” means that an SPI master writes data to GP-SPI2.

The detailed properties of each state are as follows:

1. CMD:

- Indicate the function of SPI slave;
- One byte from master to slave;
- Only the values in [Table 27-14](#) and [Table 27-15](#) are valid;
- Can be sent in 1-bit SPI mode or 4-bit QPI mode.

2. ADDR:

- The address for [Wr_BUF](#) and [Rd_BUF](#) commands in CPU-controlled transfer, or placeholder bits in other transfers and can be defined by application;
- One byte from master to slave;
- Can be sent in 1-bit, 2-bit or 4-bit modes (according to the command).

3. DUMMY:

- Its value is meaningless. SPI slave prepares data in this state;
- Bit mode of FSPI bus is also meaningless here;
- Last for eight [SPI_CLK](#) cycles.

4. DIN or DOUT:

- Data length can be 0 ~ 64 B in CPU-controlled mode and unlimited in DMA-controlled mode;
- Can be sent in 1-bit, 2-bit or 4-bit modes according to the CMD value.

Note:

The states of ADDR and DUMMY can never be skipped in any half-duplex communications.

When a half-duplex transaction is complete, the transferred CMD and ADDR values are latched into [SPI_SLV_LAST_COMMAND](#) and [SPI_SLV_LAST_ADDR](#) respectively. The [SPI_SLV_CMD_ERR_INT_RAW](#) will be

set if the transferred CMD value is not supported by GP-SPI2 as slave. The [SPI_SLV_CMD_ERR_INT_RAW](#) can only be cleared by software.

27.5.9.2 Supported CMD Values in Half-Duplex Communication

In half-duplex communication, the defined values of CMD determine the transfer types. Unsupported CMD values are disregarded, meanwhile the related transfer is ignored and [SPI_SLV_CMD_ERR_INT_RAW](#) is set. The transfer format is CMD (8 bits) + ADDR (8 bits) + DUMMY (8 SPI_CLK cycles) + DATA (unit in bytes). The detailed description of CMD[3:0] is as follows:

- 0x1 (Wr_BUF): CPU-controlled write mode. Master sends data and GP-SPI2 receives data. The data is stored in the related address of [SPI_W0_REG ~ SPI_W15_REG](#).
- 0x2 (Rd_BUF): CPU-controlled read mode. Master receives the data sent by GP-SPI2. The data comes from the related address of [SPI_W0_REG ~ SPI_W15_REG](#).
- 0x3 (Wr_DMA): DMA-controlled write mode. Master sends data and GP-SPI2 receives data. The data is stored in GP-SPI2 GDMA RX buffer.
- 0x4 (Rd_DMA): DMA-controlled read mode. Master receives the data sent by GP-SPI2. The data comes from GP-SPI2 GDMA TX buffer.
- 0x7 (CMD7): used to generate an [SPI_SLV_CMD7_INT](#) interrupt. It can also generate a [GDMA_IN_SUC_EOF_CH_n_INT](#) interrupt in a slave segmented transfer when GDMA RX link is used. But it will not end GP-SPI2's slave segmented transfer.
- 0x8 (CMD8): only used to generate an [SPI_SLV_CMD8_INT](#) interrupt, which will not end GP-SPI2's slave segmented transfer.
- 0x9 (CMD9): only used to generate an [SPI_SLV_CMD9_INT](#) interrupt, which will not end GP-SPI2's slave segmented transfer.
- 0xA (CMDA): only used to generate an [SPI_SLV_CMDA_INT](#) interrupt, which will not end GP-SPI2's slave segmented transfer.

The detailed function of CMD7, CMD8, CMD9, and CMDA commands is reserved for user definition. These commands can be used as handshake signals, as passwords of some specific functions, as triggers of some user defined actions, and so on.

1/2/4-bit modes in states of CMD, ADDR, DATA are supported, which are determined by value of CMD[7:4]. The DUMMY state is always in 1-bit mode and lasts for eight SPI_CLK cycles. The definition of CMD[7:4] is as follows:

- 0x0: CMD, ADDR, and DATA states all are in 1-bit mode.
- 0x1: CMD and ADDR are in 1-bit mode. DATA is in 2-bit mode.
- 0x2: CMD and ADDR are in 1-bit mode. DATA is in 4-bit mode.
- 0x5: CMD is in 1-bit mode. ADDR and DATA are in 2-bit mode.
- 0xA: CMD is in 1-bit mode, ADDR and DATA are in 4-bit mode or in QPI mode.

In addition, if the value of CMD[7:0] is 0x05, 0xA5, 0x06, or 0xDD, DUMMY and DATA states are skipped. The definition of CMD[7:0] is as follows:

- 0x05 (End_SEG_TRANS): master sends 0x05 command to end slave segmented transfer in SPI mode.

- 0xA5 (End_SEG_TRANS): master sends 0xA5 command to end slave segmented transfer in QPI mode.
- 0x06 (En_QPI): GP-SPI2 enters QPI mode when receiving the 0x06 command and the bit [SPI_QPI_MODE](#) in register [SPI_USER_REG](#) is set.
- 0xDD (Ex_QPI): GP-SPI2 exits QPI mode when receiving the 0xDD command and the bit [SPI_QPI_MODE](#) is cleared.

All the CMD values supported by GP-SPI2 are listed in Table 27-14 and Table 27-15. Note that DUMMY state is always in 1-bit mode and lasts for eight SPI_CLK cycles.

Table 27-14. Supported CMD Values in SPI Mode

Transfer Type	CMD[7:0]	CMD State	ADDR State	DATA State
Wr_BUF	0x01	1-bit mode	1-bit mode	1-bit mode
	0x11	1-bit mode	1-bit mode	2-bit mode
	0x21	1-bit mode	1-bit mode	4-bit mode
	0x51	1-bit mode	2-bit mode	2-bit mode
	0xA1	1-bit mode	4-bit mode	4-bit mode
Rd_BUF	0x02	1-bit mode	1-bit mode	1-bit mode
	0x12	1-bit mode	1-bit mode	2-bit mode
	0x22	1-bit mode	1-bit mode	4-bit mode
	0x52	1-bit mode	2-bit mode	2-bit mode
	0xA2	1-bit mode	4-bit mode	4-bit mode
Wr_DMA	0x03	1-bit mode	1-bit mode	1-bit mode
	0x13	1-bit mode	1-bit mode	2-bit mode
	0x23	1-bit mode	1-bit mode	4-bit mode
	0x53	1-bit mode	2-bit mode	2-bit mode
	0xA3	1-bit mode	4-bit mode	4-bit mode
Rd_DMA	0x04	1-bit mode	1-bit mode	1-bit mode
	0x14	1-bit mode	1-bit mode	2-bit mode
	0x24	1-bit mode	1-bit mode	4-bit mode
	0x54	1-bit mode	2-bit mode	2-bit mode
	0xA4	1-bit mode	4-bit mode	4-bit mode
CMD7	0x07	1-bit mode	1-bit mode	-
	0x17	1-bit mode	1-bit mode	-
	0x27	1-bit mode	1-bit mode	-
	0x57	1-bit mode	2-bit mode	-
	0xA7	1-bit mode	4-bit mode	-
CMD8	0x08	1-bit mode	1-bit mode	-
	0x18	1-bit mode	1-bit mode	-
	0x28	1-bit mode	1-bit mode	-
	0x58	1-bit mode	2-bit mode	-
	0xA8	1-bit mode	4-bit mode	-
CMD9	0x09	1-bit mode	1-bit mode	-
	0x19	1-bit mode	1-bit mode	-
	0x29	1-bit mode	1-bit mode	-
	0x59	1-bit mode	2-bit mode	-

Table 27-14. Supported CMD Values in SPI Mode

Transfer Type	CMD[7:0]	CMD State	ADDR State	DATA State
	0xA9	1-bit mode	4-bit mode	-
CMDA	0x0A	1-bit mode	1-bit mode	-
	0x1A	1-bit mode	1-bit mode	-
	0x2A	1-bit mode	1-bit mode	-
	0x5A	1-bit mode	2-bit mode	-
	0xAA	1-bit mode	4-bit mode	-
End_SEG_TRANS	0x05	1-bit mode	-	-
En_QPI	0x06	1-bit mode	-	-

Table 27-15. Supported CMD Values in QPI Mode

Transfer Type	CMD[7:0]	CMD State	ADDR State	DATA State
Wr_BUF	0xA1	4-bit mode	4-bit mode	4-bit mode
Rd_BUF	0xA2	4-bit mode	4-bit mode	4-bit mode
Wr_DMA	0xA3	4-bit mode	4-bit mode	4-bit mode
Rd_DMA	0xA4	4-bit mode	4-bit mode	4-bit mode
CMD7	0xA7	4-bit mode	4-bit mode	-
CMD8	0xA8	4-bit mode	4-bit mode	-
CMD9	0xA9	4-bit mode	4-bit mode	-
CMDA	0xAA	4-bit mode	4-bit mode	-
End_SEG_TRANS	0xA5	4-bit mode	4-bit mode	-
Ex_QPI	0xDD	4-bit mode	4-bit mode	-

Master sends 0x06 CMD (En_QPI) to set GP-SPI2 slave to QPI mode and all the states of supported transfer will be in 4-bit mode afterwards. If 0xDD CMD (Ex_QPI) is received, GP-SPI2 slave will be back to SPI mode.

Other transfer types than these described in Table 27-14 and Table 27-15 are ignored. If the transferred data is not in unit of byte, GP-SPI2 will send or receive the data in unit of byte, but the extra bits (the result of total bits mod 8) will be lost. But if the CS low time is longer than 2 APB clock (APB_CLK) cycles, [SPI_TRANS_DONE_INT](#) will be triggered. For more information on interrupts triggered at the end of transmissions, please refer to Section 27.9.

27.5.9.3 Slave Single Transfer and Slave Segmented Transfer

When GP-SPI2 works as a slave, it supports full-duplex and half-duplex communications controlled by DMA and by CPU. DMA-controlled transfer can be a single transfer, or a slave segmented transfer consisting of several transactions (segments). The CPU-controlled transfer can only be one single transfer, since each CPU-controlled transaction needs to be triggered by CPU.

In a slave segmented transfer, all transfer types listed in Table 27-14 and Table 27-15 are supported in a single transaction (segment). It means that CPU-controlled transaction and DMA-controlled transaction can be mixed in one slave segmented transfer.

It is recommended that in a slave segmented transfer:

- CPU-controlled transaction is used for handshake communication and short data transfers.
- DMA-controlled transaction is used for large data transfers.

27.5.9.4 Configuration of Slave Single Transfer

When operating as slave, GP-SPI2 supports CPU/DMA-controlled full-duplex/half-duplex single transfers. The register configuration procedure is as follows:

1. Configure the IO path via IO MUX or GPIO matrix between GP-SPI2 and an external SPI device.
2. Configure AHB clock (AHB_CLK) and APB clock (APB_CLK).
3. Set the bit `SPI_SLAVE_MODE` to enable slave mode.
4. Configure `SPI_DOUTDIN`:
 - 1: enable full-duplex communication.
 - 0: enable half-duplex communication.
5. Prepare data:
 - if CPU-controlled transfer mode is selected and GP-SPI2 is used to send data, then prepare data in registers `SPI_W0_REG` ~ `SPI_W15_REG`.
 - if DMA-controlled transfer mode is selected,
 - configure `SPI_DMA_TX_ENA/SPI_DMA_RX_ENA` and `SPI_RX_EOF_EN`,
 - configure GDMA TX/RX link,
 - and start GDMA TX/RX engine, as described in Section 27.5.6 and Section 27.5.7.
6. Set `SPI_DMA_AFIFO_RST`, `SPI_BUF_AFIFO_RST`, and `SPI_RX_AFIFO_RST` to reset these buffers.
7. Clear `SPI_DMA_SLV_SEG_TRANS_EN` in register `SPI_DMA_CONF_REG` to enable slave single transfer mode.
8. Set `SPI_TRANS_DONE_INT_ENA` in `SPI_DMA_INT_ENA_REG` and wait for the interrupt `SPI_TRANS_DONE_INT`. In DMA-controlled mode, it is recommended to wait for the interrupt `GDMA_IN_SUC_EOF_CHn_INT` when GDMA RX buffer is used, which means that data has been stored in the related memory. Other interrupts described in Section 27.9 are optional.

27.5.9.5 Configuration of Slave Segmented Transfer in Half-Duplex

GDMA must be used in this mode. The register configuration procedure is as follows:

1. Configure the IO path via IO MUX or GPIO matrix between GP-SPI2 and an external SPI device.
2. Configure AHB clock (AHB_CLK) and APB clock (APB_CLK).
3. Set `SPI_SLAVE_MODE` to enable slave mode.
4. Clear `SPI_DOUTDIN` to enable half-duplex communication.
5. Prepare data in registers `SPI_W0_REG` ~ `SPI_W15_REG`, if needed.
6. Set `SPI_DMA_AFIFO_RST`, `SPI_BUF_AFIFO_RST`, and `SPI_RX_AFIFO_RST` to reset these buffers.

7. Set bits `SPI_DMA_RX_ENA` and `SPI_DMA_TX_ENA`. Clear the bit `SPI_RX_EOF_EN`. Configure GDMA TX/RX link and start GDMA TX/RX engine, as shown in Section 27.5.6 and Section 27.5.7.
8. Set `SPI_DMA_SLV_SEG_TRANS_EN` in `SPI_DMA_CONF_REG` to enable slave segmented transfer.
9. Set `SPI_DMA_SEG_TRANS_DONE_INT_ENA` in `SPI_DMA_INT_ENA_REG` and wait for the interrupt `SPI_DMA_SEG_TRANS_DONE_INT`, which means that the segmented transfer has finished and data has been put into the related memory. Other interrupts described in Section 27.9 are optional.

When `End_SEG_TRANS` (0x05 in SPI mode, 0xA5 in QPI mode) is received by GP-SPI2, this slave segmented transfer is ended and the interrupt `SPI_DMA_SEG_TRANS_DONE_INT` is triggered.

27.5.9.6 Configuration of Slave Segmented Transfer in Full-Duplex

GDMA must be used in this mode. In such transfer, the data is transferred from and to the GDMA buffer. The interrupt `GDMA_IN_SUC_EOF_CHn_INT` is triggered when the transfer ends. The configuration procedure is as follows:

1. Configure the IO path via IO MUX or GPIO matrix between GP-SPI2 and an external SPI device.
2. Configure AHB clock (`AHB_CLK`) and APB clock (`APB_CLK`).
3. Set `SPI_SLAVE_MODE` and `SPI_DOUTDIN`, to enable full-duplex communication as slave.
4. Set `SPI_DMA_AFIFO_RST`, `SPI_BUF_AFIFO_RST`, and `SPI_RX_AFIFO_RST`, to reset these buffers.
5. Set `SPI_DMA_TX_ENA/SPI_DMA_RX_ENA`. Configure GDMA TX/RX link and start GDMA TX/RX engine, as shown in Section 27.5.6 and Section 27.5.7.
6. Set the bit `SPI_RX_EOF_EN` in register `SPI_DMA_CONF_REG`. Configure `SPI_MS_DATA_BITLEN[17:0]` in register `SPI_MS_DLEN_REG` to the byte length of the received DMA data.
7. Set `SPI_DMA_SLV_SEG_TRANS_EN` in `SPI_DMA_CONF_REG` to enable slave segmented transfer mode.
8. Set `GDMA_IN_SUC_EOF_CHn_INT_ENA` and wait for the interrupt `GDMA_IN_SUC_EOF_CHn_INT`.

27.6 CS Setup Time and Hold Time Control

SPI bus CS (`SPI_CS`) setup time and hold time are very important to meet the timing requirements of various SPI devices (e.g., flash or PSRAM).

CS setup time is the time between the CS falling edge and the first latch edge of SPI bus CLK (`SPI_CLK`). The first latch edge for mode 0 and mode 3 is rising edge, and falling edge for mode 2 and mode 4.

CS hold time is the time between the last latch edge of `SPI_CLK` and the CS rising edge.

When operating as slave, the CS setup time and hold time should be longer than $0.5 \times T_{\text{SPI_CLK}}$, otherwise the SPI transfer may be incorrect. $T_{\text{SPI_CLK}}$ is one cycle of `SPI_CLK`.

When operating as master, set the CS setup time by specifying `SPI_CS_SETUP` in `SPI_USER_REG` and `SPI_CS_SETUP_TIME` in `SPI_USER1_REG`:

- If `SPI_CS_SETUP` is cleared, the SPI CS setup time is $0.5 \times T_{\text{SPI_CLK}}$.
- If `SPI_CS_SETUP` is set, the SPI CS setup time is $(\text{SPI_CS_SETUP_TIME} + 1.5) \times T_{\text{SPI_CLK}}$.

Set the CS hold time by specifying `SPI_CS_HOLD` in `SPI_USER_REG` and `SPI_CS_HOLD_TIME` in `SPI_USER1_REG`:

- If `SPI_CS_HOLD` is cleared, the SPI CS hold time is $0.5 \times T_{\text{SPI_CLK}}$;
- If `SPI_CS_HOLD` is set, the SPI CS hold time is $(\text{SPI_CS_HOLD_TIME} + 1.5) \times T_{\text{SPI_CLK}}$.

Figure 27-11 and Figure 27-12 show the recommended CS timing and register configuration to access external RAM and flash.

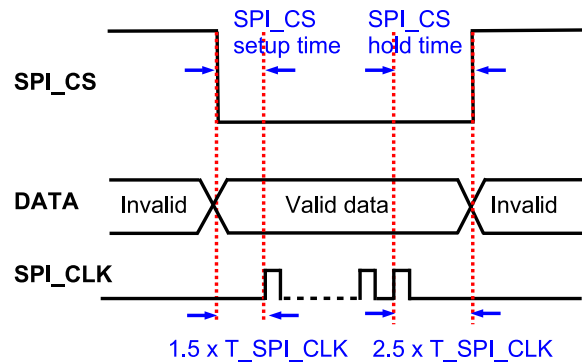

Register Configurations:

`SPI_CS_SETUP = 1; SPI_CS_SETUP_TIME = 0;`
`SPI_CS_HOLD = 1; SPI_CS_HOLD_TIME = 1.`

Figure 27-11. Recommended CS Timing and Settings When Accessing External RAM

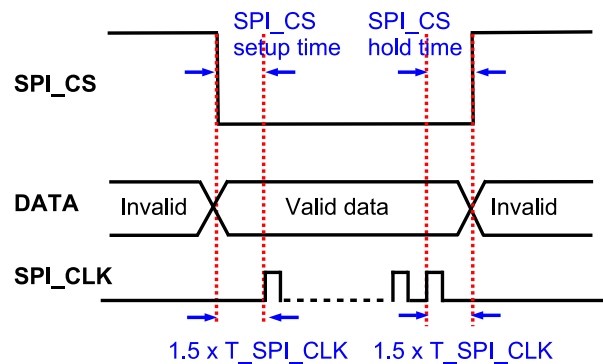

Register Configurations:

`SPI_CS_SETUP = 1; SPI_CS_SETUP_TIME = 0;`
`SPI_CS_HOLD = 1; SPI_CS_HOLD_TIME = 0.`

Figure 27-12. Recommended CS Timing and Settings When Accessing Flash

27.7 GP-SPI2 Clock Control

GP-SPI2 has the following clocks:

- `clk_spi_mst`: module clock of GP-SPI2, derived from `PLL_CLK`. Used in GP-SPI2 as master to generate `SPI_CLK` signal for data transfer and for slaves.

- SPI_CLK: output clock as master.
- AHB_CLK/APB_CLK: clock for register configuration.

clk_spi_mst is enabled by PCR_SPI2_MST_CLK_ACTIVE_I and its clock source is controlled by PCR_SPI2_MST_CLK_SEL_I[1:0]:

- 0: XTAL_CLK
- 1: PLL_F80M_CLK
- 2: RC_FAST_CLK

When operating as master, the maximum output clock frequency of GP-SPI2 is $f_{clk_spi_mst}$. To have slower frequencies, the output clock frequency can be divided as follows:

$$f_{SPI_CLK} = \frac{f_{clk_spi_mst}}{(SPI_CLKCNT_N + 1)(SPI_CLKDIV_PRE + 1)}$$

The divider is configured by SPI_CLKCNT_N and SPI_CLKDIV_PRE in register SPI_CLOCK_REG. When the bit SPI_CLK_EQU_SYSCLK in register SPI_CLOCK_REG is set to 1, the output clock frequency of GP-SPI2 will be $f_{clk_spi_mst}$. For other integral clock divisions, SPI_CLK_EQU_SYSCLK should be set to 0.

When operating as slave, the supported input clock frequency (f_{SPI_CLK}) of GP-SPI2 is:

- If $f_{AHB_CLK} \geq 60$ MHz, $f_{SPI_CLK} \leq 60$ MHz;
- If $f_{AHB_CLK} < 60$ MHz, $f_{SPI_CLK} \leq f_{APB_CLK}$.

27.7.1 Clock Phase and Polarity

SPI protocol has four clock modes, i.e., modes 0 ~ 3. See Figure 27-13 and Figure 27-14 (excerpted from SPI protocol):

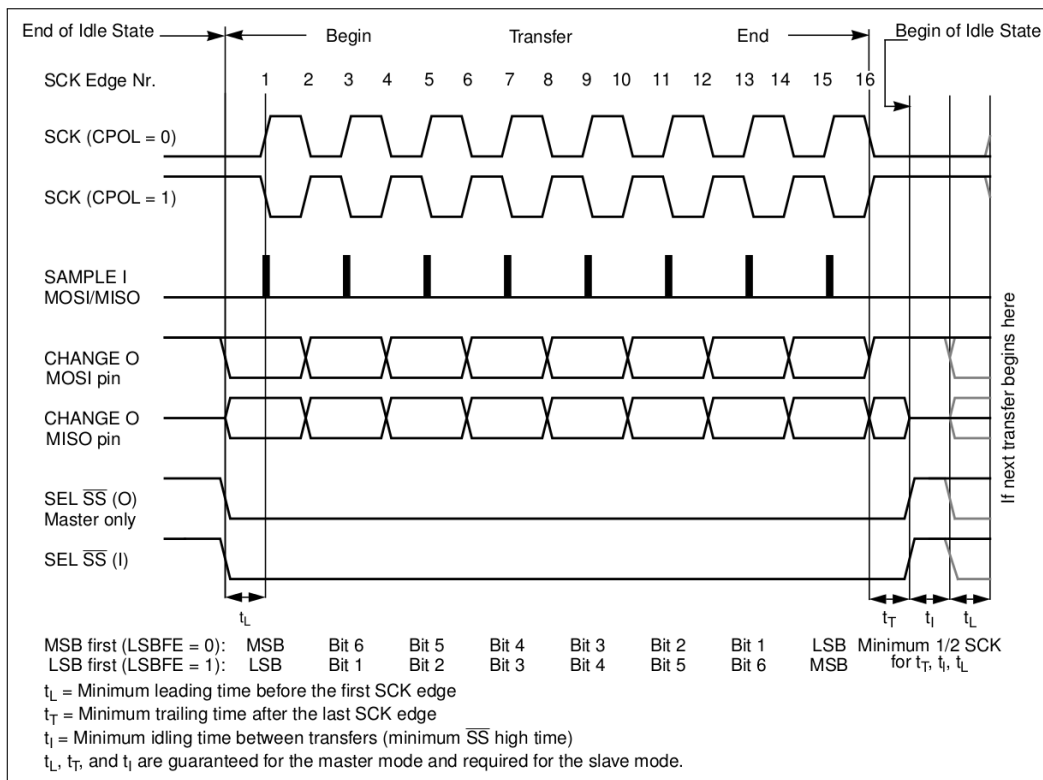

Figure 27-13. SPI Clock Mode 0 or 2

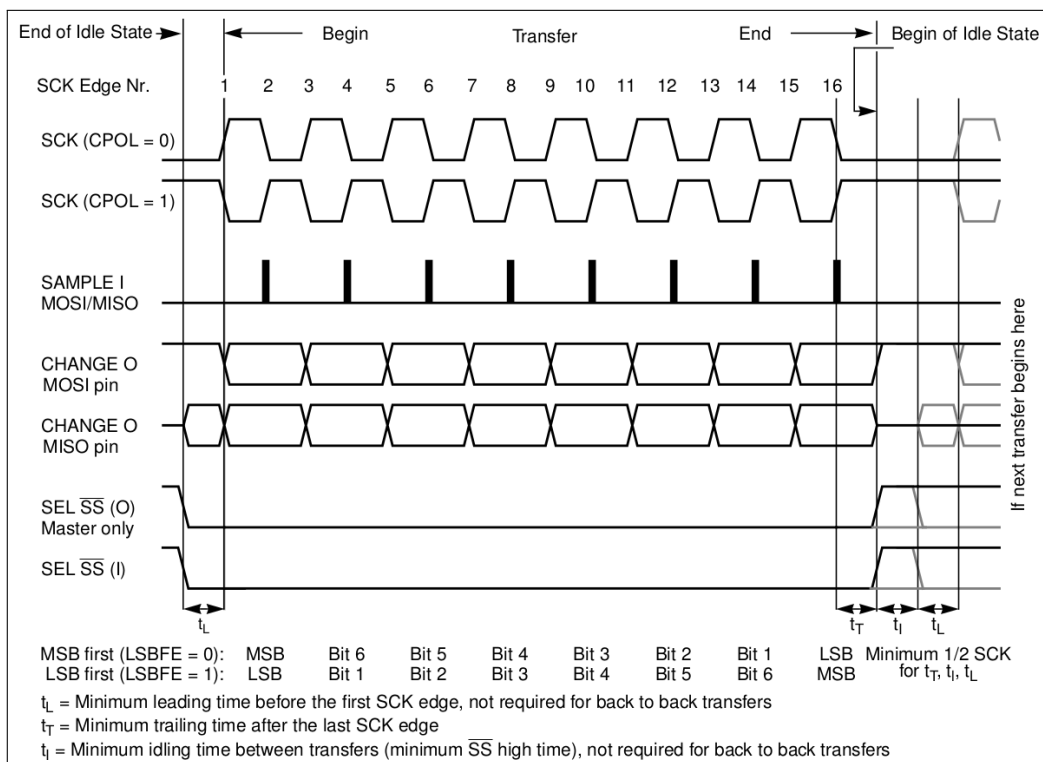

Figure 27-14. SPI Clock Mode 1 or 3

1. Mode 0: CPOL = 0, CPHA = 0; SCK is 0 when the SPI is in idle state; data is changed on the negative edge of SCK and sampled on the positive edge. The first data is shifted out before the first negative edge of SCK.
2. Mode 1: CPOL = 0, CPHA = 1; SCK is 0 when the SPI is in idle state; data is changed on the positive edge

of SCK and sampled on the negative edge.

3. Mode 2: CPOL = 1, CPHA = 0; SCK is 1 when the SPI is in idle state; data is changed on the positive edge of SCK and sampled on the negative edge. The first data is shifted out before the first positive edge of SCK.
4. Mode 3: CPOL = 1, CPHA = 1; SCK is 1 when the SPI is in idle state; data is changed on the negative edge of SCK and sampled on the positive edge.

27.7.2 Clock Control as Master

The four clock modes 0 ~ 3 are supported in GP-SPI2 as master. The polarity and phase of GP-SPI2 clock are controlled by the bit [SPI_CK_IDLE_EDGE](#) in register [SPI_MISC_REG](#) and the bit [SPI_CK_OUT_EDGE](#) in register [SPI_USER_REG](#). The register configuration for SPI clock modes 0 ~ 3 is provided in Table 27-16, and can be changed according to the path delay in the application.

Table 27-16. Clock Phase and Polarity Configuration as Master

Control Bit	Mode 0	Mode 1	Mode 2	Mode 3
SPI_CK_IDLE_EDGE	0	0	1	1
SPI_CK_OUT_EDGE	0	1	1	0

[SPI_CLK_MODE](#) is used to select the number of rising edges of SPI_CLK when SPI_CS raises high to be 0, 1, 2 or SPI_CLK always on.

Note:

When [SPI_CLK_MODE](#) is configured to 1 or 2, the bit [SPI_CS_HOLD](#) must be set and the value of [SPI_CS_HOLD_TIME](#) should be larger than 1.

27.7.3 Clock Control as Slave

GP-SPI2 as slave also supports clock modes 0 ~ 3. The polarity and phase are configured by the bits [SPI_TSCK_I_EDGE](#) and [SPI_RSCK_I_EDGE](#) in register [SPI_USER_REG](#). The output edge of data is controlled by [SPI_CLK_MODE_13](#) in register [SPI_SLAVE_REG](#). The detailed register configuration is shown in Table 27-17:

Table 27-17. Clock Phase and Polarity Configuration as Slave

Control Bit	Mode 0	Mode 1	Mode 2	Mode 3
SPI_TSCK_I_EDGE	0	1	1	0
SPI_RSCK_I_EDGE	0	1	1	0
SPI_CLK_MODE_13	0	1	0	1

27.8 GP-SPI2 Timing Compensation

Introduction

The I/O lines are mapped via GPIO Matrix or IO MUX. But there is no timing adjustment in IO MUX. The input data and output data can be delayed for 1 or 2 IO MUX operating clock cycles at the rising or falling edge in GPIO matrix. For detailed register configuration, see Chapter 7 *IO MUX and GPIO Matrix (GPIO, IO MUX)*.

Figure 27-15 shows the timing compensation control for GP-SPI2 as master, including the following paths:

- “CLK”: the output path of GP-SPI2 bus clock. The clock is sent out by SPI_CLK out control module, passes through GPIO Matrix or IO MUX and then goes to an external SPI device.
- “IN”: data input path of GP-SPI2. The input data from an external SPI device passes through GPIO Matrix or IO MUX, then is adjusted by the Timing Module and finally is stored into spi_rx_afifo.
- “OUT”: data output path of GP-SPI2. The output data is sent out to the Timing Module, passes through GPIO Matrix or IO MUX and is then captured by an external SPI device.

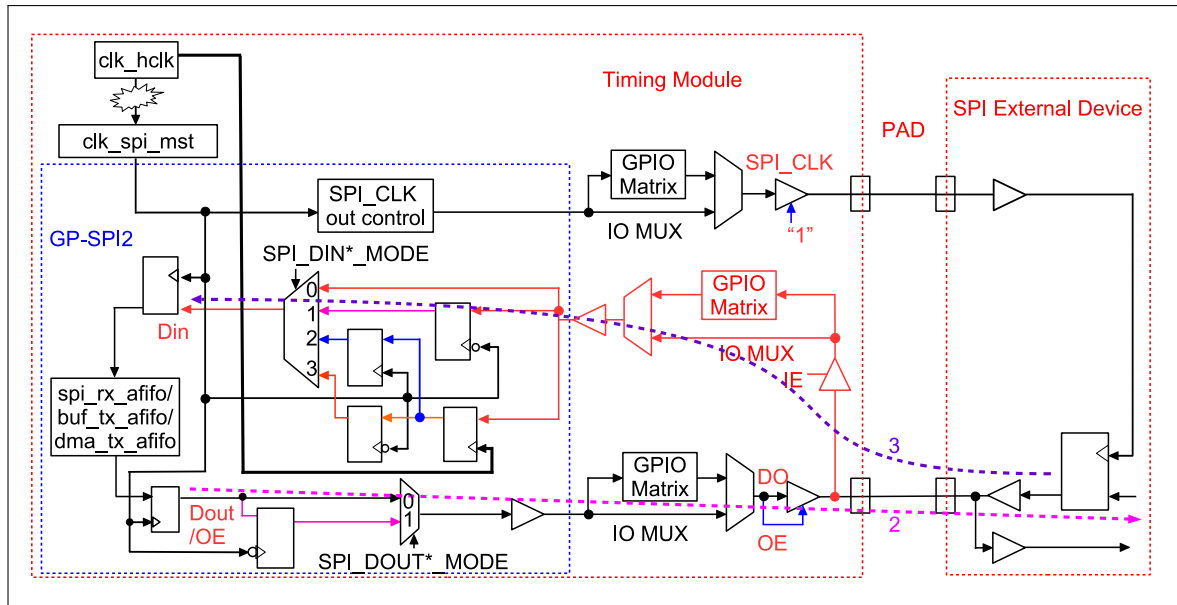

Figure 27-15. Timing Compensation Control Diagram in GP-SPI2 as Master

Every input and output data is passing through the Timing Module and the module can be used to apply delay in units of $T_{clk_spi_mst}$ (one cycle of clk_spi_mst) on rising or falling edge.

Key Registers

- `SPI_DIN_MODE_REG`: select the latch edge of input data
- `SPI_DIN_NUM_REG`: select the delay cycles of input data
- `SPI_DOUT_MODE_REG`: select the latch edge of output data

Timing Compensation Example

Figure 27-16 shows a timing compensation example in GP-SPI2 as master. Note that DUMMY cycle length is configurable to compensate the delay in I/O lines, so as to enhance the performance of GP-SPI2.

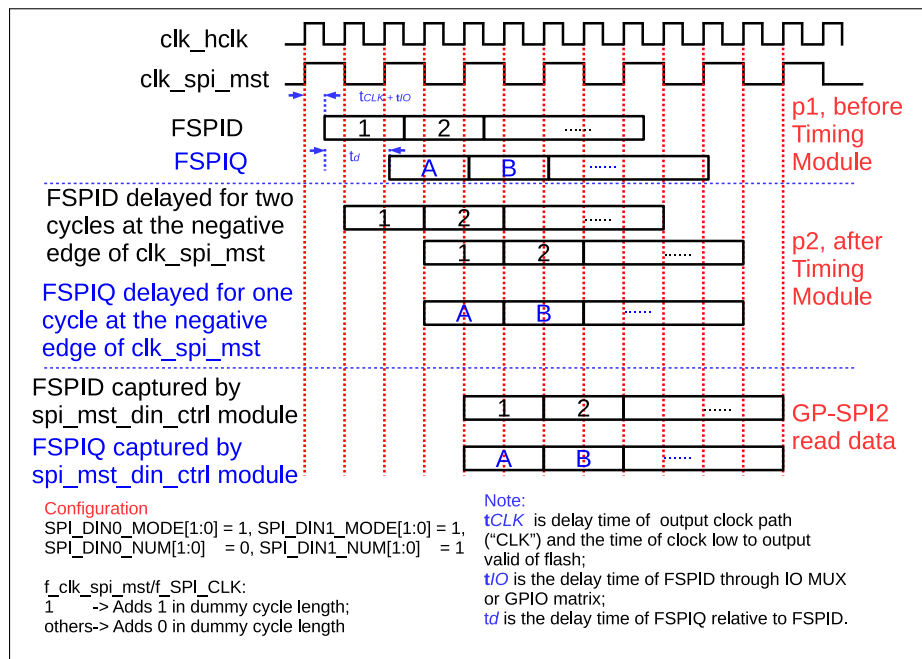

Figure 27-16. Timing Compensation Example in GP-SPI2 as Master

In Figure 27-16, “p1” is the point of input data of Timing Module, “p2” is the point of output data of Timing Module. Since the input data FSPIQ is unaligned to FSPID, the read data of GP-SPI2 will be wrong without the timing compensation.

To get the correct read data, follow the settings below. Assuming $f_{clk_spi_mst}$ equals to f_{SPI_CLK} :

- Delay FSPID for two cycles at the falling edge of `clk_spi_mst`.
- Delay FSPIQ for one cycle at the falling edge of `clk_spi_mst`.
- Add one extra dummy cycle.

When GP-SPI2 works as slave, if the bit `SPI_RSCK_DATA_OUT` in register `SPI_SLAVE_REG` is set to 1, the output data is sent at latch edge, which is half an SPI clock cycle earlier. This can be used for slave mode timing compensation.

27.9 Interrupts

Interrupt Summary

GP-SPI2 provides an SPI interface interrupt `SPI_INT`. When an SPI transfer ends, an interrupt is generated in GP-SPI2.

- `SPI_DMA_INFIFO_FULL_ERR_INT`: triggered when the length of GDMA RX FIFO is shorter than that of actual data transferred.
- `SPI_DMA_OUTFIFO_EMPTY_ERR_INT`: triggered when the length of GDMA TX FIFO is shorter than that of actual data transferred.
- `SPI_SLV_EX_QPI_INT`: triggered when Ex_QPI is received correctly in GP-SPI2 as slave and the SPI transfer ends.

- SPI_SLV_EN_QPI_INT: triggered when En_QPI is received correctly in GP-SPI2 as slave and the SPI transfer ends.
- SPI_SLV_CMD7_INT: triggered when CMD7 is received correctly in GP-SPI2 as slave and the SPI transfer ends.
- SPI_SLV_CMD8_INT: triggered when CMD8 is received correctly in GP-SPI2 as slave and the SPI transfer ends.
- SPI_SLV_CMD9_INT: triggered when CMD9 is received correctly in GP-SPI2 as slave and the SPI transfer ends.
- SPI_SLV_CMDA_INT: triggered when CMDA is received correctly in GP-SPI2 as slave and the SPI transfer ends.
- SPI_SLV_RD_DMA_DONE_INT: triggered at the end of Rd_DMA transfer as slave.
- SPI_SLV_WR_DMA_DONE_INT: triggered at the end of Wr_DMA transfer as slave.
- SPI_SLV_RD_BUF_DONE_INT: triggered at the end of Rd_BUF transfer as slave.
- SPI_SLV_WR_BUF_DONE_INT: triggered at the end of Wr_BUF transfer as slave.
- SPI_TRANS_DONE_INT: triggered at the end of SPI bus transfer in both as master and as slave.
- SPI_DMA_SEG_TRANS_DONE_INT: triggered at the end of End_SEG_TRANS transfer in GP-SPI2 slave segmented transfer mode or at the end of configurable segmented transfer as master.
- SPI_SEG_MAGIC_ERR_INT: triggered when a Magic error occurs in CONF buffer during configurable segmented transfer as master.
- SPI_MST_RX_AFIFO_WFULL_ERR_INT: triggered by RX AFIFO write-full error in GP-SPI2 as master.
- SPI_MST_TX_AFIFO_EMPTY_ERR_INT: triggered by TX AFIFO read-empty error in GP-SPI2 as master.
- SPI_SLV_CMD_ERR_INT: triggered when a received command value is not supported in GP-SPI2 as slave.
- SPI_APP2_INT: used and triggered by software. Only used for user defined function.
- SPI_APP1_INT: used and triggered by software. Only used for user defined function.

Interrupts Used as Master and Slave

Table 27-18 and Table 27-19 show the interrupts used in GP-SPI2 as master and as slave, respectively. Set the interrupt enable bit SPI*_INT_ENA in [SPI_DMA_INT_ENA_REG](#) and wait for the SPI_INT interrupt. When the transfer ends, the related interrupt is triggered and should be cleared by software before the next transfer.

Table 27-18. GP-SPI2 Interrupts as Master

Transfer Type	Communication Mode	Controlled by	Interrupt
Single Transfer	Full-duplex	DMA	GDMA_IN_SUC_EOF_CH n _INT ¹
		CPU	SPI_TRANS_DONE_INT ²
	Half-duplex MOSI	DMA	SPI_TRANS_DONE_INT
		CPU	SPI_TRANS_DONE_INT
	Half-duplex MISO	DMA	GDMA_IN_SUC_EOF_CH n _INT
		CPU	SPI_TRANS_DONE_INT
Configurable Segmented Transfer	Full-duplex	DMA	SPI_DMA_SEG_TRANS_DONE_INT ³
		CPU	Not supported
	Half-duplex MOSI	DMA	SPI_DMA_SEG_TRANS_DONE_INT
		CPU	Not supported
	Half-duplex MISO	DMA	SPI_DMA_SEG_TRANS_DONE_INT
		CPU	Not supported

¹ If GDMA_IN_SUC_EOF_CH n _INT is triggered, it means all the RX data of GP-SPI2 has been stored in the RX buffer, and the TX data has been transferred to the slave.

² SPI_TRANS_DONE_INT is triggered when CS is high, which indicates that master has completed the data exchange in SPI_W0_REG ~ SPI_W15_REG with slave in this mode.

³ If SPI_DMA_SEG_TRANS_DONE_INT is triggered, it means that the whole configurable segmented transfer (consisting of several segments) has finished, i.e., the RX data has been stored in the RX buffer completely and all the TX data has been sent out.

Table 27-19. GP-SPI2 Interrupts as Slave

Transfer Type	Communication Mode	Controlled by	Interrupt
Single Transfer	Full-duplex	DMA	GDMA_IN_SUC_EOF_CH n _INT ¹
		CPU	SPI_TRANS_DONE_INT ²
	Half-duplex MOSI	DMA (Wr_DMA)	GDMA_IN_SUC_EOF_CH n _INT ³
		CPU (Wr_BUF)	SPI_TRANS_DONE_INT ⁴
	Half-duplex MISO	DMA (Rd_DMA)	SPI_TRANS_DONE_INT ⁵
		CPU (Rd_BUF)	SPI_TRANS_DONE_INT ⁶
Slave Segmented Transfer	Full-duplex	DMA	GDMA_IN_SUC_EOF_CH n _INT ⁷
		CPU	Not supported ⁸
	Half-duplex MOSI	DMA (Wr_DMA)	SPI_DMA_SEG_TRANS_DONE_INT ⁹
		CPU (Wr_BUF)	Not supported ¹⁰
	Half-duplex MISO	DMA (Rd_DMA)	SPI_DMA_SEG_TRANS_DONE_INT ¹¹
		CPU (Rd_BUF)	Not supported ¹²

Continued on the next page

Table 27-19 – Continued from the previous page

Transfer Type	Communication Mode	Controlled by	Interrupt
---------------	--------------------	---------------	-----------

¹ If `GDMA_IN_SUC_EOF_CH n _INT` is triggered, it means all the RX data has been stored in the RX buffer, and the TX data has been sent to the slave.

² `SPI_TRANS_DONE_INT` is triggered when CS is high, which indicates that master has completed the data exchange in `SPI_W0_REG` ~ `SPI_W15_REG` with slave in this mode.

³ `SPI_SLV_WR_DMA_DONE_INT` just means that the transmission on the SPI bus is done, but can not ensure that all the push data has been stored in the RX buffer. For this reason, `GDMA_IN_SUC_EOF_CH n _INT` is recommended.

⁴ Or wait for `SPI_SLV_WR_BUF_DONE_INT`.

⁵ Or wait for `SPI_SLV_RD_DMA_DONE_INT`.

⁶ Or wait for `SPI_SLV_RD_BUF_DONE_INT`.

⁷ Slave should set the total read data byte length in `SPI_MS_DATA_BITLEN` before the transfer begins. Set `SPI_RX_EOF_EN` to 1 before the end of the interrupt program.

⁸ Master and slave should define a method to end the segmented transfer, such as via GPIO interrupt.

⁹ Master sends `End_SEG_TRAN` to end the segmented transfer or slave sets the total read data byte length in `SPI_MS_DATA_BITLEN` and waits for `GDMA_IN_SUC_EOF_CH n _INT`.

¹⁰ Half-duplex `Wr_BUF` single transfer can be used in a slave segmented transfer.

¹¹ Master sends `End_SEG_TRAN` to end the segmented transfer.

¹² Half-duplex `Rd_BUF` single transfer can be used in a slave segmented transfer.

27.10 Register Summary

The addresses in this section are relative to SPI base address provided in Table 5-2 in Chapter 5 *System and Memory*.

The abbreviations given in Column **Access** are explained in Section *Access Types for Registers*.

Name	Description	Address	Access
User-defined control registers			
<code>SPI_CMD_REG</code>	Command control register	0x0000	varies
<code>SPI_ADDR_REG</code>	Address value register	0x0004	R/W
<code>SPI_USER_REG</code>	SPI USER control register	0x0010	varies
<code>SPI_USER1_REG</code>	SPI USER control register 1	0x0014	R/W
<code>SPI_USER2_REG</code>	SPI USER control register 2	0x0018	R/W
Control and configuration registers			
<code>SPI_CTRL_REG</code>	SPI control register	0x0008	varies
<code>SPI_MS_DLEN_REG</code>	SPI data bit length control register	0x001C	R/W
<code>SPI_MISC_REG</code>	SPI misc register	0x0020	varies
<code>SPI_DMA_CONF_REG</code>	SPI DMA control register	0x0030	varies
<code>SPI_SLAVE_REG</code>	SPI slave control register	0x00E0	varies
<code>SPI_SLAVE1_REG</code>	SPI slave control register 1	0x00E4	R/W/SS
Clock control registers			
<code>SPI_CLOCK_REG</code>	SPI clock control register	0x000C	R/W
<code>SPI_CLK_GATE_REG</code>	SPI module clock and register clock control	0x00E8	R/W
Timing registers			

Name	Description	Address	Access
SPI_DIN_MODE_REG	SPI input delay mode configuration	0x0024	varies
SPI_DIN_NUM_REG	SPI input delay number configuration	0x0028	varies
SPI_DOUT_MODE_REG	SPI output delay mode configuration	0x002C	varies
Interrupt registers			
SPI_DMA_INT_ENA_REG	SPI interrupt enable register	0x0034	R/W
SPI_DMA_INT_CLR_REG	SPI interrupt clear register	0x0038	WT
SPI_DMA_INT_RAW_REG	SPI interrupt raw register	0x003C	R/WTC/SS
SPI_DMA_INT_ST_REG	SPI interrupt status register	0x0040	RO
SPI_DMA_INT_SET_REG	SPI interrupt software set register	0x0044	WT
CPU-controlled data buffer			
SPI_W0_REG	SPI CPU-controlled buffer0	0x0098	R/W/SS
SPI_W1_REG	SPI CPU-controlled buffer1	0x009C	R/W/SS
SPI_W2_REG	SPI CPU-controlled buffer2	0x00A0	R/W/SS
SPI_W3_REG	SPI CPU-controlled buffer3	0x00A4	R/W/SS
SPI_W4_REG	SPI CPU-controlled buffer4	0x00A8	R/W/SS
SPI_W5_REG	SPI CPU-controlled buffer5	0x00AC	R/W/SS
SPI_W6_REG	SPI CPU-controlled buffer6	0x00B0	R/W/SS
SPI_W7_REG	SPI CPU-controlled buffer7	0x00B4	R/W/SS
SPI_W8_REG	SPI CPU-controlled buffer8	0x00B8	R/W/SS
SPI_W9_REG	SPI CPU-controlled buffer9	0x00BC	R/W/SS
SPI_W10_REG	SPI CPU-controlled buffer10	0x00C0	R/W/SS
SPI_W11_REG	SPI CPU-controlled buffer11	0x00C4	R/W/SS
SPI_W12_REG	SPI CPU-controlled buffer12	0x00C8	R/W/SS
SPI_W13_REG	SPI CPU-controlled buffer13	0x00CC	R/W/SS
SPI_W14_REG	SPI CPU-controlled buffer14	0x00D0	R/W/SS
SPI_W15_REG	SPI CPU-controlled buffer15	0x00D4	R/W/SS
Version register			
SPI_DATE_REG	Version control	0x00F0	R/W

27.11 Registers

The addresses in this section are relative to SPI base address provided in Table 5-2 in Chapter 5 *System and Memory*.

Register 27.1. SPI_CMD_REG (0x0000)

<i>(reserved)</i>							<i>SPI_USR SPI_UPDATE</i>		<i>(reserved)</i>							<i>SPI_CONF_BITLEN</i>									
31							25	24	23	22						18	17							0	
0							0	0	0	0	0					0	0	0						0	Reset

SPI_CONF_BITLEN Configures the SPI_CLK cycles of SPI CONF state. (R/W)

Measurement unit: SPI_CLK clock cycle.

Can be configured in CONF state.

SPI_UPDATE Configures whether or not to synchronize SPI registers from APB clock domain into SPI module clock domain. (WT)

- 0: Not synchronize
- 1: Synchronize

This bit is only used in SPI master transfer.

SPI_USR Configures whether or not to enable user-defined command. (R/W/SC)

- 0: Not enable
- 1: Enable

An SPI operation will be triggered when the bit is set. This bit will be cleared once the operation is done. Can not be changed by CONF_buf.

Register 27.2. SPI_ADDR_REG (0x0004)

<i>SPI_USR_ADDR_VALUE</i>																																
31																															0	
0																																Reset

SPI_USR_ADDR_VALUE Configures the address to slave. (R/W)

Can be configured in CONF state.

Register 27.3. SPI_USER_REG (0x0010)

31	30	29	28	27	26	25	24	23		18	17	16	15	14	13	12	11	10	9	8	7	6	5	4	3	2	1	0	
1	0	0	0	0	0	0	0	0	0	0	0	0	0	0	0	0	0	0	0	0	0	1	1	0	0	0	0	0	0

Reset

SPI_DOUTDIN Configures whether or not to enable full-duplex communication. (R/W)

- 0: Disable
- 1: Enable

Can be configured in CONF state.

SPI_QPI_MODE Configures whether or not to enable QPI mode. (R/W/SS/SC)

- 0: Disable
- 1: Enable

This configuration is applicable when the SPI controller works as master or slave. Can be configured in CONF state.

SPI_TSCK_I_EDGE Configures whether or not to change the polarity of TSCK in slave transfer. (R/W)

- 0: TSCK = SPI_CK_I
- 1: TSCK = !SPI_CK_I

SPI_CS_HOLD Configures whether or not to keep SPI CS low when SPI is in DONE state. (R/W)

- 0: Not keep low
- 1: Keep low

Can be configured in CONF state.

SPI_CS_SETUP Configures whether or not to enable SPI CS when SPI is in prepare (PREP) state. (R/W)

- 0: Disable
- 1: Enable

Can be configured in CONF state.

SPI_RSCK_I_EDGE Configures whether or not to change the polarity of RSCK in slave transfer. (R/W)

- 0: RSCK = !SPI_CK_I
- 1: RSCK = SPI_CK_I

Continued on the next page...

Register 27.3. SPI_USER_REG (0x0010)

Continued from the previous page...

SPI_CK_OUT_EDGE Configures SPI clock mode together with [SPI_CK_IDLE_EDGE](#). (R/W)

Can be configured in CONF state. For more information, see Section [27.7.2](#).

SPI_FWRITE_DUAL Configures whether or not to enable the 2-bit mode of read-data phase in write operations. (R/W)

- 0: Not enable
- 1: Enable

Can be configured in CONF state.

SPI_FWRITE_QUAD Configures whether or not to enable the 4-bit mode of read-data phase in write operations. (R/W)

- 0: Not enable
- 1: Enable

Can be configured in CONF state.

SPI_USR_CONF_NXT Configures whether or not to enable the CONF state for the next transaction (segment) in a configurable segmented transfer. (R/W)

- 0: this transfer will end after the current transaction (segment) is finished. Or this is not a configurable segmented transfer.
- 1: this configurable segmented transfer will continue its next transaction (segment).

Can be configured in CONF state.

SPI_SIO Configures whether or not to enable 3-line half-duplex communication, where MOSI and MISO signals share the same pin. (R/W)

- 0: Disable
- 1: Enable

Can be configured in CONF state.

SPI_USR_MISO_HIGHPART Configures whether or not to enable “high part mode”, i.e., only access to high part of the buffers: [SPI_W8_REG](#) ~ [SPI_W15_REG](#) in read-data phase. (R/W)

- 0: Disable
- 1: Enable

Can be configured in CONF state.

Continued on the next page...

Register 27.3. SPI_USER_REG (0x0010)

Continued from the previous page...

SPI_USR_MOSI_HIGHPART Configures whether or not to enable "high part mode", i.e., only access to high part of the buffers: [SPI_W8_REG](#) ~ [SPI_W15_REG](#) in write-data phase. (R/W)

- 0: Disable
- 1: Enable

Can be configured in CONF state. (R/W)

SPI_USR_DUMMY_IDLE Configures whether or not to disable SPI clock in DUMMY state. (R/W)

- 0: Not disable
- 1: Disable

Can be configured in CONF state.

SPI_USR_MOSI Configures whether or not to enable the write-data (DOUT) state of an operation. (R/W)

- 0: Disable
- 1: Enable

Can be configured in CONF state.

SPI_USR_MISO Configures whether or not to enable the read-data (DIN) state of an operation. (R/W)

- 0: Disable
- 1: Enable

Can be configured in CONF state.

SPI_USR_DUMMY Configures whether or not to enable the DUMMY state of an operation. (R/W)

- 0: Disable
- 1: Enable

Can be configured in CONF state.

SPI_USR_ADDR Configures whether or not to enable the address (ADDR) state of an operation. (R/W)

- 0: Disable
- 1: Enable

Can be configured in CONF state.

Continued on the next page...

Register 27.3. SPI_USER_REG (0x0010)

Continued from the previous page...

SPI_USR_COMMAND Configures whether or not to enable the command (CMD) state of an operation. (R/W)

- 0: Disable
- 1: Enable

Can be configured in CONF state.

Register 27.4. SPI_USER1_REG (0x0014)

<i>SPI_USR_ADDR_BITLEN</i>		<i>SPI_CS_HOLD_TIME</i>				<i>SPI_CS_SETUP_TIME</i>				<i>SPI_MST_WFULL_ERR_END_EN</i>				<i>(reserved)</i>		<i>SPI_USR_DUMMY_CYCLELEN</i>						
31	27	26	22	21	17	16	15	8	7	0												
23		0x1				0				1				0 0 0 0 0 0 0 0				7				Reset

SPI_USR_DUMMY_CYCLELEN Configures the length of DUMMY state. (R/W)

Measurement unit: SPI_CLK clock cycles.

This value is (the expected cycle number - 1). Can be configured in CONF state.

SPI_MST_WFULL_ERR_END_EN Configures whether or not to end the SPI transfer when SPI RX AFIFO wfull error occurs in master full-/half-duplex transfers. (R/W)

- 0: Not end
- 1: End

SPI_CS_SETUP_TIME Configures the length of prepare (PREP) state. (R/W)

Measurement unit: SPI_CLK clock cycles.

This value is equal to the expected cycles - 1. This field is used together with [SPI_CS_SETUP](#).

Can be configured in CONF state.

SPI_CS_HOLD_TIME Configures the delay cycles of CS pin. (R/W)

Measurement unit: SPI_CLK clock cycles.

This field is used together with [SPI_CS_HOLD](#). Can be configured in CONF state.

SPI_USR_ADDR_BITLEN Configures the bit length in address state. (R/W)

This value is (expected bit number - 1). Can be configured in CONF state.

Register 27.5. SPI_USER2_REG (0x0018)

SPI_USR_COMMAND_BITLEN		SPI_MST_REMPTY_ERR_END_EN		(reserved)												SPI_USR_COMMAND_VALUE																		
31	28	27	26													16	15																	0
7		1	0 0 0 0 0 0 0 0 0 0 0 0 0 0												0																Reset			

SPI_USR_COMMAND_VALUE Configures the command value. (R/W)

Can be configured in CONF state. (R/W)

SPI_MST_REMPTY_ERR_END_EN Configures whether or not to end the SPI transfer when SPI TX AFIFO read empty error occurs in master full-/half-duplex transfers. (R/W)

- 0: Not end
- 1: End

SPI_USR_COMMAND_BITLEN Configures the bit length of command state. (R/W)

This value is (expected bit number - 1). Can be configured in CONF state.

Register 27.6. SPI_CTRL_REG (0x0008)

31	27	26	25	24	23	22	21	20	19	18	17	16	15	14	13	10	9	8	7	6	5	4	3	2	0	
0	0	0	0	0	0	0	1	1	1	1	0	0	0	0	0	0	0	0	0	0	0	0	0	0	0	0

Reset

SPI_DUMMY_OUT Configures whether or not to output the FSPI bus signals in DUMMY state. (R/W)

- 0: Not output
- 1: Output

Can be configured in CONF state.

SPI_FADDR_DUAL Configures whether or not to enable 2-bit mode during address (ADDR) state. (R/W)

- 0: Disable
- 1: Enable

Can be configured in CONF state.

SPI_FADDR_QUAD Configures whether or not to enable 4-bit mode during address (ADDR) state. (R/W)

- 0: Disable
- 1: Enable

Can be configured in CONF state.

SPI_FCMD_DUAL Configures whether or not to enable 2-bit mode during command (CMD) state. (R/W)

- 0: Disable
- 1: Enable

Can be configured in CONF state. (R/W)

SPI_FCMD_QUAD Configures whether or not to enable 4-bit mode during command (CMD) state. (R/W)

- 0: Disable
- 1: Enable

Can be configured in CONF state. (R/W)

Continued on the next page...

Register 27.6. SPI_CTRL_REG (0x0008)

Continued from the previous page...

SPI_FREAD_DUAL Configures whether or not to enable the 2-bit mode of read-data (DIN) state in read operations. (R/W)

- 0: Disable
- 1: Enable

Can be configured in CONF state.

SPI_FREAD_QUAD Configures whether or not to enable the 4-bit mode of read-data (DIN) state in read operations. (R/W)

- 0: Disable
- 1: Enable

Can be configured in CONF state.

SPI_Q_POL Configures MISO line polarity. (R/W)

- 0: Low
- 1: High

Can be configured in CONF state.

SPI_D_POL Configures MOSI line polarity. (R/W)

- 0: Low
- 1: High

Can be configured in CONF state.

SPI_HOLD_POL Configures SPI_HOLD output value when SPI is in idle. (R/W)

- 0: Output low
- 1: Output high

Can be configured in CONF state.

SPI_WP_POL Configures the output value of write-protect signal when SPI is in idle. (R/W)

- 0: Output low
- 1: Output high

Can be configured in CONF state.

Continued on the next page...

Register 27.6. SPI_CTRL_REG (0x0008)

Continued from the previous page...

SPI_RD_BIT_ORDER Configures the bit order in read-data (MISO) state. (R/W)

- 0: MSB first
- 1: LSB first

Can be configured in CONF state.

SPI_WR_BIT_ORDER Configures the bit order in command (CMD), address (ADDR), and write-data (MOSI) states. (R/W)

- 0: MSB first
- 1: LSB first

Can be configured in CONF state.

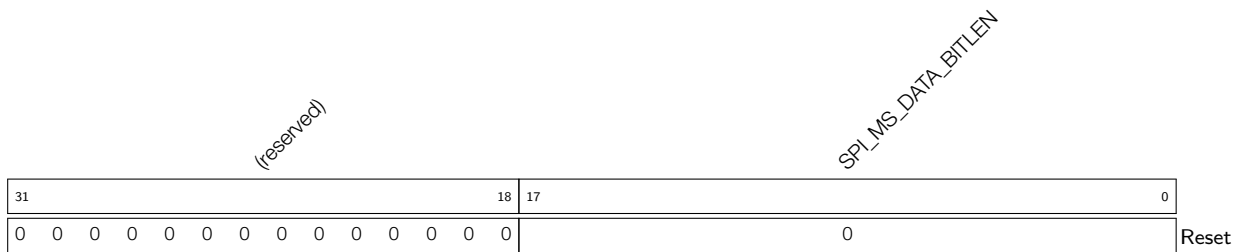
Register 27.7. SPI_MS_DLEN_REG (0x001C)

SPI_MS_DATA_BITLEN Configures the data bit length of SPI transfer in DMA-controlled master transfer or in CPU-controlled master transfer. Or configures the bit length of SPI RX transfer in DMA-controlled slave transfer. (R/W)

This value shall be (expected bit_num - 1). Can be configured in CONF state.

Register 27.8. SPI_MISC_REG (0x0020)

(reserved)				SPI_CS_KEEP_ACTIVE				SPI_CLK_IDLE_EDGE				(reserved)				SPI_SLAVE_CS_POL				(reserved)				SPI_MASTER_CS_POL				SPI_CLK_DIS				SPI_CS5_DIS				SPI_CS4_DIS				SPI_CS3_DIS				SPI_CS2_DIS				SPI_CS1_DIS				SPI_CS0_DIS			
31	30	29	28	27	26	25	24	23	22	21	20	19	18	17	16	15	14	13	12	11	10	9	8	7	6	5	4	3	2	1	0																								
0	0	0	0	0	0	0	0	0	0	0	0	0	0	0	0	0	0	0	0	0	0	0	0	0	0	1	1	1	1	1	1	0																							

Reset

SPI_CS n _DIS ($n = 0 \sim 5$) Configures whether or not to disable SPI_CS n pin. (R/W)

- 0: SPI_CS n signal is from/to SPI_CS n pin.
- 1: Disable SPI_CS n pin.

Can be configured in CONF state.

SPI_CLK_DIS Configures whether or not to disable SPI_CLK output. (R/W)

- 0: Enable
- 1: Disable

Can be configured in CONF state.

SPI_MASTER_CS_POL[n] Configures the polarity of SPI_CS n ($n = 0 \sim 5$) line in master transfer. (R/W)

- 0: SPI_CS n is low active.
- 1: SPI_CS n is high active.

Can be configured in CONF state.

SPI_SLAVE_CS_POL Configures whether or not invert SPI slave input CS polarity. (R/W)

- 0: Not change
- 1: Invert

Can be configured in CONF state.

SPI_CLK_IDLE_EDGE Configures the level of SPI_CLK line when GP-SPI2 is in idle. (R/W)

- 0: Low
- 1: High

Can be configured in CONF state.

SPI_CS_KEEP_ACTIVE Configures whether or not to keep the SPI_CS line low. (R/W)

- 0: Not keep low
- 1: Keep low

Can be configured in CONF state.

Register 27.9. SPI_DMA_CONF_REG (0x0030)

31	30	29	28	27	26	25	24	23	22	21	20	19	18	17	16	15	14	13	12	11	10	9	8	7	6	5	4	3	2	1	0
0	0	0	0	0	0	0	0	0	0	0	0	0	0	0	0	0	0	0	0	0	0	0	0	0	0	0	0	0	0	1	1

SPI_DMA_AFFO_RST
 SPI_BUF_AFFO_RST
 SPI_RX_AFFO_RST
 SPI_DMA_TX_ENA
 SPI_DMA_RX_ENA
 (reserved)
 SPI_RX_EOF_EN
 SPI_SLV_TX_SEG_TRANS_CLR_EN
 SPI_SLV_RX_SEG_TRANS_CLR_EN
 SPI_DMA_SLV_SEG_TRANS_EN
 (reserved)
 SPI_DMA_INFIFO_FULL
 SPI_DMA_OUTFIFO_EMPTY

SPI_DMA_OUTFIFO_EMPTY Represents whether or not the DMA TX FIFO is ready for sending data. (RO)

- 0: Ready
- 1: Not ready

SPI_DMA_INFIFO_FULL Represents whether or not the DMA RX FIFO is ready for receiving data. (RO)

- 0: Ready
- 1: Not ready

SPI_DMA_SLV_SEG_TRANS_EN Configures whether or not to enable DMA-controlled segmented transfer in slave half-duplex communication. (R/W)

- 0: Disable
- 1: Enable

SPI_SLV_RX_SEG_TRANS_CLR_EN In slave segmented transfer, if the size of the DMA RX buffer is smaller than the size of the received data, 1: the data in all the following Wr_DMA transactions will not be received; 0: the data in this Wr_DMA transaction will not be received, but in the following transactions, (R/W)

- if the size of DMA RX buffer is not 0, the data in following Wr_DMA transactions will be received.
- if the size of DMA RX buffer is 0, the data in following Wr_DMA transactions will not be received.

SPI_SLV_TX_SEG_TRANS_CLR_EN In slave segmented transfer, if the size of the DMA TX buffer is smaller than the size of the transmitted data, (R/W)

- 1: the data in the following transactions will not be updated, i.e. the old data is transmitted repeatedly.
- 0: the data in this transaction will not be updated. But in the following transactions,
 - if new data is filled in DMA TX FIFO, new data will be transmitted.
 - if no new data is filled in DMA TX FIFO, no new data will be transmitted.

Continued on the next page...

Register 27.9. SPI_DMA_CONF_REG (0x0030)

Continued from the previous page...

SPI_RX_EOF_EN 1: In a DAM-controlled transfer, if the bit number of transferred data is equal to ($SPI_MS_DATA_BITLEN + 1$), then $GDMA_IN_SUC_EOF_CH_n_INT_RAW$ will be set by hardware.
0: $GDMA_IN_SUC_EOF_CH_n_INT_RAW$ is set by [SPI_TRANS_DONE_INT](#) event in a single transfer, or by an [SPI_DMA_SEG_TRANS_DONE_INT](#) event in a segmented transfer. (R/W)

SPI_DMA_RX_ENA Configures whether or not to enable DMA-controlled receive data transfer. (R/W)

- 0: Disable
- 1: Enable

SPI_DMA_TX_ENA Configures whether or not to enable DMA-controlled send data transfer. (R/W)

- 0: Disable
- 1: Enable

SPI_RX_AFIFO_RST Configures whether or not to reset `spi_rx_afifo` as shown in Figure 27-4 and in Figure 27-5. (WT)

- 0: Not reset
- 1: Reset

`spi_rx_afifo` is used to receive data in SPI master and slave transfer.

SPI_BUF_AFIFO_RST Configures whether or not to reset `buf_tx_afifo` as shown in Figure 27-4 and in Figure 27-5. (WT)

- 0: Not reset
- 1: Reset

`buf_tx_afifo` is used to send data out in CPU-controlled master and slave transfer.

SPI_DMA_AFIFO_RST Configures whether or not to reset `dma_tx_afifo` as shown in Figure 27-4 and in Figure 27-5. (WT)

- 0: Not reset
- 1: Reset

`dma_tx_afifo` is used to send data out in DMA-controlled slave transfer.

Register 27.10. SPI_SLAVE_REG (0x00E0)

(reserved)		SPI_MST_FD_WAIT_DMA_TX_DATA		SPI_USR_CONF		SPI_SOFT_RESET		SPI_SLAVE_MODE		SPI_DMA_SEG_MAGIC_VALUE		(reserved)		SPI_SLV_WRBUF_BITLEN_EN		SPI_SLV_RDIBUF_BITLEN_EN		SPI_SLV_WRDMA_BITLEN_EN		SPI_SLV_RDDMA_BITLEN_EN		(reserved)		SPI_RSCK_DATA_OUT		SPI_CLK_MODE_13		SPI_CLK_MODE	
31	30	29	28	27	26	25	22	21						12	11	10	9	8	7			4	3	2	1	0			
0	0	0	0	0	0	0	10	0	0	0	0	0	0	0	0	0	0	0	0	0	0	0	0	0	0	0	0	0	0

Reset

SPI_CLK_MODE Configures SPI clock mode. (R/W)

- 0: SPI clock is off when CS becomes inactive.
- 1: SPI clock is delayed one cycle after CS becomes inactive.
- 2: SPI clock is delayed two cycles after CS becomes inactive.
- 3: SPI clock is always on.

Can be configured in CONF state.

SPI_CLK_MODE_13 Configure clock mode. (R/W)

- 0: Support SPI clock mode 0 or 2. See Table 27-17.
- 1: Support SPI clock mode 1 or 3. See Table 27-17.

SPI_RSCK_DATA_OUT Configures the edge of output data. (R/W)

- 0: Output data at TSCK rising edge.
- 1: Output data at RSCK rising edge.

SPI_SLV_RDDMA_BITLEN_EN Configures whether or not to use [SPI_SLV_DATA_BITLEN](#) to store the data bit length of Rd_DMA transfer. (R/W)

- 0: Not use
- 1: Use

SPI_SLV_WRDMA_BITLEN_EN Configures whether or not to use [SPI_SLV_DATA_BITLEN](#) to store the data bit length of Wr_DMA transfer. (R/W)

- 0: Not use
- 1: Use

Continued on the next page...

Register 27.10. SPI_SLAVE_REG (0x00E0)

Continued from the previous page...

SPI_SLV_RDBUF_BITLEN_EN Configures whether or not to use [SPI_SLV_DATA_BITLEN](#) to store the data bit length of Rd_BUF transfer. (R/W)

- 0: Not use
- 1: Use

SPI_SLV_WRBUF_BITLEN_EN Configures whether or not to use [SPI_SLV_DATA_BITLEN](#) to store the data bit length of Wr_BUF transfer. (R/W)

- 0: Not use
- 1: Use

SPI_DMA_SEG_MAGIC_VALUE Configures the magic value of BM table in DMA-controlled configurable segmented transfer. (R/W)

SPI_SLAVE_MODE Configures SPI work mode. (R/W)

- 0: Master
- 1: Slave

SPI_SOFT_RESET Configures whether to reset the SPI clock line, CS line, and data line via software. (WT)

- 0: Not reset
- 1: Reset

Can be configured in CONF state.

SPI_USR_CONF Configures whether or not to enable the CONF state of current DMA-controlled configurable segmented transfer. (R/W)

- 0: No effect, which means the current transfer is not a configurable segmented transfer.
- 1: Enable, which means a configurable segmented transfer is started.

SPI_MST_FD_WAIT_DMA_TX_DATA Configures whether or not to wait DMA TX data gets ready before starting SPI transfer in master full-duplex transfer. (R/W)

- 0: Not wait
- 1: Wait

Register 27.11. SPI_SLAVE1_REG (0x00E4)

SPI_SLV_LAST_ADDR										SPI_SLV_LAST_COMMAND										SPI_SLV_DATA_BITLEN										
31						26	25						18	17											0					
0										0										0										Reset

SPI_SLV_DATA_BITLEN Configures the transferred data bit length in SPI slave full-/half-duplex modes. (R/W/SS)

SPI_SLV_LAST_COMMAND Configures the command value in slave mode. (R/W/SS)

SPI_SLV_LAST_ADDR Configures the address value in slave mode. (R/W/SS)

Register 27.12. SPI_CLOCK_REG (0x000C)

SPI_CLK_EQU_SYSCLK										(reserved)										SPI_CLKDIV_PRE										SPI_CLKCNT_N										SPI_CLKCNT_H										SPI_CLKCNT_L										
31						30						22	21						18	17						12	11						6	5						0																				
1										0 0 0 0 0 0 0 0 0 0										0										0x3										0x1										0x3										Reset

SPI_CLKCNT_L In master transfer, this field must be equal to SPI_CLKCNT_N. In slave mode, it must be 0. Can be configured in CONF state. (R/W)

SPI_CLKCNT_H Configures the duty cycle of SPI_CLK (high level) in master transfer. (R/W)
It's recommended to configure this value to $\text{floor}((\text{SPI_CLKCNT_N} + 1)/2 - 1)$. $\text{floor}()$ here is to round a number down, e.g., $\text{floor}(2.2) = 2$. In slave mode, it must be 0.
Can be configured in CONF state.

SPI_CLKCNT_N Configures the divider of SPI_CLK in master transfer. (R/W)
SPI_CLK frequency is $f_{\text{clk_spi_mst}}/(\text{SPI_CLKDIV_PRE} + 1)/(\text{SPI_CLKCNT_N} + 1)$.
Can be configured in CONF state.

SPI_CLKDIV_PRE Configures the pre-divider of SPI_CLK in master transfer. (R/W)
Can be configured in CONF state.

SPI_CLK_EQU_SYSCLK Configures whether or not the SPI_CLK is equal to clk_spi_mst in master transfer. (R/W)

- 0: SPI_CLK is divided from clk_spi_mst.
- 1: SPI_CLK is equal to clk_spi_mst.

Can be configured in CONF state.

Register 27.13. SPI_CLK_GATE_REG (0x00E8)

(reserved)																(reserved)			(reserved)	SPI_CLK_EN												
31																												3	2	1	0	
0 0																											0	0	0	0	Reset	

SPI_CLK_EN Configures whether or not to enable clock gate. (R/W)

- 0: Disable
- 1: Enable

Register 27.14. SPI_DIN_MODE_REG (0x0024)

(reserved)										SPI_TIMING_HCLK_ACTIVE								(reserved)										SPI_DIN3_MODE		SPI_DIN2_MODE		SPI_DIN1_MODE		SPI_DIN0_MODE					
31																																							
0																		0		0		0		0		0		0		0		0		0		Reset			

SPI_DIN0_MODE Configures the input mode for FSPID signal. (R/W)

- 0: Input without delay
- 1: Input at the (SPI_DIN0_NUM + 1)th falling edge of clk_spi_mst
- 2: Input at the (SPI_DIN0_NUM + 1)th rising edge of clk_hclk plus one clk_spi_mst rising edge cycle
- 3: Input at the (SPI_DIN0_NUM + 1)th rising edge of clk_hclk plus one clk_spi_mst falling edge cycle

Can be configured in CONF state.

SPI_DIN1_MODE Configures the input mode for FSPIQ signal. (R/W)

- 0: Input without delay
- 1: Input at the (SPI_DIN1_NUM+1)th falling edge of clk_spi_mst
- 2: Input at the (SPI_DIN1_NUM + 1)th rising edge of clk_hclk plus one clk_spi_mst rising edge cycle
- 3: Input at the (SPI_DIN1_NUM + 1)th rising edge of clk_hclk plus one clk_spi_mst falling edge cycle

Can be configured in CONF state.

SPI_DIN2_MODE Configures the input mode for FSPIWP signal. (R/W)

- 0: Input without delay
- 1: Input at the (SPI_DIN2_NUM + 1)th falling edge of clk_spi_mst
- 2: Input at the (SPI_DIN2_NUM + 1)th rising edge of clk_hclk plus one clk_spi_mst rising edge cycle
- 3: Input at the (SPI_DIN2_NUM + 1)th rising edge of clk_hclk plus one clk_spi_mst falling edge cycle

Can be configured in CONF state.

Continued on the next page...

Register 27.14. SPI_DIN_MODE_REG (0x0024)

Continued from the previous page...

SPI_DIN3_MODE Configures the input mode for FSPIHD signal. (R/W)

- 0: Input without delay
- 1: Input at the ([SPI_DIN3_NUM](#) + 1)th falling edge of `clk_spi_mst`
- 2: Input at the ([SPI_DIN3_NUM](#) + 1)th rising edge of `clk_hclk` plus one `clk_spi_mst` rising edge cycle
- 3: Input at the ([SPI_DIN3_NUM](#) + 1)th rising edge of `clk_hclk` plus one `clk_spi_mst` falling edge cycle

Can be configured in CONF state.

SPI_TIMING_HCLK_ACTIVE Configures whether or not to enable HCLK (high-frequency clock) in SPI input timing module. (R/W)

- 0: Disable
- 1: Enable

Can be configured in CONF state.

Register 27.15. SPI_DIN_NUM_REG (0x0028)

(reserved)								SPI_DIN3_NUM		SPI_DIN2_NUM		SPI_DIN1_NUM		SPI_DIN0_NUM		
31								8	7	6	5	4	3	2	1	0
0								0	0	0	0	0	0	0	Reset	

SPI_DIN0_NUM Configures the delays to input signal FSPID based on the setting of [SPI_DIN0_MODE](#). (R/W)

- 0: Delayed by 1 clock cycle
- 1: Delayed by 2 clock cycles
- 2: Delayed by 3 clock cycles
- 3: Delayed by 4 clock cycles

Can be configured in CONF state.

SPI_DIN1_NUM Configures the delays to input signal FSPIQ based on the setting of [SPI_DIN1_MODE](#). (R/W)

- 0: Delayed by 1 clock cycle
- 1: Delayed by 2 clock cycles
- 2: Delayed by 3 clock cycles
- 3: Delayed by 4 clock cycles

Can be configured in CONF state.

SPI_DIN2_NUM Configures the delays to input signal FSPIWP based on the setting of [SPI_DIN2_MODE](#). (R/W)

- 0: Delayed by 1 clock cycle
- 1: Delayed by 2 clock cycles
- 2: Delayed by 3 clock cycles
- 3: Delayed by 4 clock cycles

Can be configured in CONF state.

SPI_DIN3_NUM Configures the delays to input signal FSPIHD based on the setting of [SPI_DIN3_MODE](#). (R/W)

- 0: Delayed by 1 clock cycle
- 1: Delayed by 2 clock cycles
- 2: Delayed by 3 clock cycles
- 3: Delayed by 4 clock cycles

Can be configured in CONF state.

Register 27.16. SPI_DOUT_MODE_REG (0x002C)

(reserved)																SPI_DOUT3_MODE SPI_DOUT2_MODE SPI_DOUT1_MODE SPI_DOUT0_MODE				
31															4	3	2	1	0	Reset
0																0	0	0	0	

SPI_DOUT0_MODE Configures the output mode for FSPID signal. (R/W)

- 0: Output without delay
- 1: Output with a delay of a SPI module clock cycle at its falling edge

Can be configured in CONF state.

SPI_DOUT1_MODE Configures the output mode for FSPIQ signal. (R/W)

- 0: Output without delay
- 1: Output with a delay of a SPI module clock cycle at its falling edge

Can be configured in CONF state.

SPI_DOUT2_MODE Configures the output mode for FSPIWP signal. (R/W)

- 0: Output without delay
- 1: Output with a delay of a SPI module clock cycle at its falling edge

Can be configured in CONF state.

SPI_DOUT3_MODE Configures the output mode for FSPIHD signal. (R/W)

- 0: Output without delay
- 1: Output with a delay of a SPI module clock cycle at its falling edge

Can be configured in CONF state.

Register 27.17. SPI_DMA_INT_ENA_REG (0x0034)

(reserved)												SPI_APP1_INT_ENA SPI_APP2_INT_ENA SPI_MST_TX_AFIFO_EMPTY_ERR_INT_ENA SPI_MST_RX_AFIFO_WFULL_ERR_INT_ENA SPI_SLV_CMD_ERR_INT_ENA (reserved) SPI_SEG_MAGIC_ERR_INT_ENA SPI_DMA_SEG_TRANS_DONE_INT_ENA SPI_TRANS_DONE_INT_ENA SPI_SLV_WR_BUF_DONE_INT_ENA SPI_SLV_RD_BUF_DONE_INT_ENA SPI_SLV_WR_DMA_DONE_INT_ENA SPI_SLV_RD_DMA_DONE_INT_ENA SPI_SLV_CMD9_INT_ENA SPI_SLV_CMD8_INT_ENA SPI_SLV_CMD7_INT_ENA SPI_SLV_EX_QPI_INT_ENA SPI_SLV_EN_QPI_INT_ENA SPI_DMA_OUTFIFO_EMPTY_ERR_INT_ENA SPI_DMA_INFIFO_FULL_ERR_INT_ENA																			
31	21	20	19	18	17	16	15	14	13	12	11	10	9	8	7	6	5	4	3	2	1	0									
0	0	0	0	0	0	0	0	0	0	0	0	0	0	0	0	0	0	0	0	0	0	0	0	Reset							

- SPI_DMA_INFIFO_FULL_ERR_INT_ENA** Write 1 to enable [SPI_DMA_INFIFO_FULL_ERR_INT](#) interrupt. (R/W)
 - SPI_DMA_OUTFIFO_EMPTY_ERR_INT_ENA** Write 1 to enable [SPI_DMA_OUTFIFO_EMPTY_ERR_INT](#) interrupt. (R/W)
 - SPI_SLV_EX_QPI_INT_ENA** Write 1 to enable [SPI_SLV_EX_QPI_INT](#) interrupt. (R/W)
 - SPI_SLV_EN_QPI_INT_ENA** Write 1 to enable [SPI_SLV_EN_QPI_INT](#) interrupt. (R/W)
 - SPI_SLV_CMD7_INT_ENA** Write 1 to enable [SPI_SLV_CMD7_INT](#) interrupt. (R/W)
 - SPI_SLV_CMD8_INT_ENA** Write 1 to enable [SPI_SLV_CMD8_INT](#) interrupt. (R/W)
 - SPI_SLV_CMD9_INT_ENA** Write 1 to enable [SPI_SLV_CMD9_INT](#) interrupt. (R/W)
 - SPI_SLV_CMDA_INT_ENA** Write 1 to enable [SPI_SLV_CMDA_INT](#) interrupt. (R/W)
 - SPI_SLV_RD_DMA_DONE_INT_ENA** Write 1 to enable [SPI_SLV_RD_DMA_DONE_INT](#) interrupt. (R/W)
 - SPI_SLV_WR_DMA_DONE_INT_ENA** Write 1 to enable [SPI_SLV_WR_DMA_DONE_INT](#) interrupt. (R/W)
 - SPI_SLV_RD_BUF_DONE_INT_ENA** Write 1 to enable [SPI_SLV_RD_BUF_DONE_INT](#) interrupt. (R/W)
 - SPI_SLV_WR_BUF_DONE_INT_ENA** Write 1 to enable [SPI_SLV_WR_BUF_DONE_INT](#) interrupt. (R/W)
 - SPI_TRANS_DONE_INT_ENA** Write 1 to enable [SPI_TRANS_DONE_INT](#) interrupt. (R/W)
 - SPI_DMA_SEG_TRANS_DONE_INT_ENA** Write 1 to enable [SPI_DMA_SEG_TRANS_DONE_INT](#) interrupt. (R/W)
 - SPI_SEG_MAGIC_ERR_INT_ENA** Write 1 to enable [SPI_SEG_MAGIC_ERR_INT](#) interrupt. (R/W)
- Continued on the next page...

Register 27.17. SPI_DMA_INT_ENA_REG (0x0034)

Continued from the previous page...

SPI_SLV_CMD_ERR_INT_ENA Write 1 to enable [SPI_SLV_CMD_ERR_INT](#) interrupt. (R/W)

SPI_MST_RX_AFIFO_WFULL_ERR_INT_ENA Write 1 to enable [SPI_MST_RX_AFIFO_WFULL_ERR_INT](#) interrupt. (R/W)

SPI_MST_TX_AFIFO_EMPTY_ERR_INT_ENA Write 1 to enable [SPI_MST_TX_AFIFO_EMPTY_ERR_INT](#) interrupt. (R/W)

SPI_APP2_INT_ENA Write 1 to enable [SPI_APP2_INT](#) interrupt. (R/W)

SPI_APP1_INT_ENA Write 1 to enable [SPI_APP1_INT](#) interrupt. (R/W)

Register 27.18. SPI_DMA_INT_CLR_REG (0x0038)

(reserved)											SPI_APP1_INT_CLR SPI_APP2_INT_CLR SPI_MST_TX_AFIFO_EMPTY_ERR_INT_CLR SPI_MST_RX_AFIFO_WFULL_ERR_INT_CLR SPI_SLV_CMD_ERR_INT_CLR (reserved) SPI_SEG_MAGIC_ERR_INT_CLR SPI_DMA_SEG_TRANS_DONE_INT_CLR SPI_TRANS_DONE_INT_CLR SPI_SLV_WR_BUF_DONE_INT_CLR SPI_SLV_RD_BUF_DONE_INT_CLR SPI_SLV_WR_DMA_DONE_INT_CLR SPI_SLV_RD_DMA_DONE_INT_CLR SPI_SLV_CMD9_INT_CLR SPI_SLV_CMD8_INT_CLR SPI_SLV_CMD7_INT_CLR SPI_SLV_EX_QPI_INT_CLR SPI_DMA_OUTFIFO_EMPTY_ERR_INT_CLR SPI_DMA_INFIFO_FULL_ERR_INT_CLR																					
31	30	29	28	27	26	25	24	23	22	21	20	19	18	17	16	15	14	13	12	11	10	9	8	7	6	5	4	3	2	1	0	
0	0	0	0	0	0	0	0	0	0	0	0	0	0	0	0	0	0	0	0	0	0	0	0	0	0	0	0	0	0	0	0	0

Reset

SPI_DMA_INFIFO_FULL_ERR_INT_CLR Write 1 to clear [SPI_DMA_INFIFO_FULL_ERR_INT](#) interrupt. (WT)

SPI_DMA_OUTFIFO_EMPTY_ERR_INT_CLR Write 1 to clear [SPI_DMA_OUTFIFO_EMPTY_ERR_INT](#) interrupt. (WT)

SPI_SLV_EX_QPI_INT_CLR Write 1 to clear [SPI_SLV_EX_QPI_INT](#) interrupt. (WT)

SPI_SLV_EN_QPI_INT_CLR Write 1 to clear [SPI_SLV_EN_QPI_INT](#) interrupt. (WT)

SPI_SLV_CMD7_INT_CLR Write 1 to clear [SPI_SLV_CMD7_INT](#) interrupt. (WT)

SPI_SLV_CMD8_INT_CLR Write 1 to clear [SPI_SLV_CMD8_INT](#) interrupt. (WT)

SPI_SLV_CMD9_INT_CLR Write 1 to clear [SPI_SLV_CMD9_INT](#) interrupt. (WT)

SPI_SLV_CMDA_INT_CLR Write 1 to clear [SPI_SLV_CMDA_INT](#) interrupt. (WT)

SPI_SLV_RD_DMA_DONE_INT_CLR Write 1 to clear [SPI_SLV_RD_DMA_DONE_INT](#) interrupt. (WT)

SPI_SLV_WR_DMA_DONE_INT_CLR Write 1 to clear [SPI_SLV_WR_DMA_DONE_INT](#) interrupt. (WT)

SPI_SLV_RD_BUF_DONE_INT_CLR Write 1 to clear [SPI_SLV_RD_BUF_DONE_INT](#) interrupt. (WT)

SPI_SLV_WR_BUF_DONE_INT_CLR Write 1 to clear [SPI_SLV_WR_BUF_DONE_INT](#) interrupt. (WT)

SPI_TRANS_DONE_INT_CLR Write 1 to clear [SPI_TRANS_DONE_INT](#) interrupt. (WT)

SPI_DMA_SEG_TRANS_DONE_INT_CLR Write 1 to clear [SPI_DMA_SEG_TRANS_DONE_INT](#) interrupt. (WT)

SPI_SEG_MAGIC_ERR_INT_CLR Write 1 to clear [SPI_SEG_MAGIC_ERR_INT](#) interrupt. (WT)

Continued on the next page...

Register 27.18. SPI_DMA_INT_CLR_REG (0x0038)

Continued from the previous page...

SPI_SLV_CMD_ERR_INT_CLR Write 1 to clear [SPI_SLV_CMD_ERR_INT](#) interrupt. (WT)

SPI_MST_RX_AFIFO_WFULL_ERR_INT_CLR Write 1 to clear [SPI_MST_RX_AFIFO_WFULL_ERR_INT](#) interrupt. (WT)

SPI_MST_TX_AFIFO_EMPTY_ERR_INT_CLR Write 1 to clear [SPI_MST_TX_AFIFO_EMPTY_ERR_INT](#) interrupt. (WT)

SPI_APP2_INT_CLR Write 1 to clear [SPI_APP2_INT](#) interrupt. (WT)

SPI_APP1_INT_CLR Write 1 to clear [SPI_APP1_INT](#) interrupt. (WT)

Register 27.19. SPI_DMA_INT_RAW_REG (0x003C)

(reserved)																					SPI_APP1_INT_RAW SPI_APP2_INT_RAW SPI_MST_TX_AFFO_EMPTY_ERR_INT_RAW SPI_MST_RX_AFFO_WFULL_ERR_INT_RAW SPI_SLV_CMD_ERR_INT_RAW (reserved) SPI_SEG_MAGIC_ERR_INT_RAW SPI_DMA_SEG_TRANS_DONE_INT_RAW SPI_TRANS_DONE_INT_RAW SPI_SLV_WR_BUF_DONE_INT_RAW SPI_SLV_RD_BUF_DONE_INT_RAW SPI_SLV_WR_DMA_DONE_INT_RAW SPI_SLV_RD_DMA_DONE_INT_RAW SPI_SLV_CMD9_INT_RAW SPI_SLV_CMD8_INT_RAW SPI_SLV_CMD7_INT_RAW SPI_SLV_EN_QPI_INT_RAW SPI_SLV_EX_QPI_INT_RAW SPI_DMA_OUTFIFO_EMPTY_ERR_INT_RAW SPI_DMA_INFIFO_FULL_ERR_INT_RAW																				
31	21	20	19	18	17	16	15	14	13	12	11	10	9	8	7	6	5	4	3	2	1	0	Reset																		
0	0	0	0	0	0	0	0	0	0	0	0	0	0	0	0	0	0	0	0	0	0	0	0	0																	

SPI_DMA_INFIFO_FULL_ERR_INT_RAW The raw interrupt status of [SPI_DMA_INFIFO_FULL_ERR_INT](#) interrupt. (R/WTC/SS)

SPI_DMA_OUTFIFO_EMPTY_ERR_INT_RAW The raw interrupt status of [SPI_DMA_OUTFIFO_EMPTY_ERR_INT](#) interrupt. (R/WTC/SS)

SPI_SLV_EX_QPI_INT_RAW The raw interrupt status of [SPI_SLV_EX_QPI_INT](#) interrupt. (R/WTC/SS)

SPI_SLV_EN_QPI_INT_RAW The raw interrupt status of [SPI_SLV_EN_QPI_INT](#) interrupt. (R/WTC/SS)

SPI_SLV_CMD7_INT_RAW The raw interrupt status of [SPI_SLV_CMD7_INT](#) interrupt. (R/WTC/SS)

SPI_SLV_CMD8_INT_RAW The raw interrupt status of [SPI_SLV_CMD8_INT](#) interrupt. (R/WTC/SS)

SPI_SLV_CMD9_INT_RAW The raw interrupt status of [SPI_SLV_CMD9_INT](#) interrupt. (R/WTC/SS)

SPI_SLV_CMDA_INT_RAW The raw interrupt status of [SPI_SLV_CMDA_INT](#) interrupt. (R/WTC/SS)

SPI_SLV_RD_DMA_DONE_INT_RAW The raw interrupt status of [SPI_SLV_RD_DMA_DONE_INT](#) interrupt. (R/WTC/SS)

SPI_SLV_WR_DMA_DONE_INT_RAW The raw interrupt status of [SPI_SLV_WR_DMA_DONE_INT](#) interrupt. (R/WTC/SS)

SPI_SLV_RD_BUF_DONE_INT_RAW The raw interrupt status of [SPI_SLV_RD_BUF_DONE_INT](#) interrupt. (R/WTC/SS)

SPI_SLV_WR_BUF_DONE_INT_RAW The raw interrupt status of [SPI_SLV_WR_BUF_DONE_INT](#) interrupt. (R/WTC/SS)

SPI_TRANS_DONE_INT_RAW The raw interrupt status of [SPI_TRANS_DONE_INT](#) interrupt. (R/WTC/SS)

Continued on the next page...

Register 27.19. SPI_DMA_INT_RAW_REG (0x003C)

Continued from the previous page...

SPI_DMA_SEG_TRANS_DONE_INT_RAW The raw interrupt status of [SPI_DMA_SEG_TRANS_DONE_INT](#) interrupt. (R/WTC/SS)

SPI_SEG_MAGIC_ERR_INT_RAW The raw interrupt status of [SPI_SEG_MAGIC_ERR_INT](#) interrupt. (R/WTC/SS)

SPI_SLV_CMD_ERR_INT_RAW The raw interrupt status of [SPI_SLV_CMD_ERR_INT](#) interrupt. (R/WTC/SS)

SPI_MST_RX_AFIFO_WFULL_ERR_INT_RAW The raw interrupt status of [SPI_MST_RX_AFIFO_WFULL_ERR_INT](#) interrupt. (R/WTC/SS)

SPI_MST_TX_AFIFO_EMPTY_ERR_INT_RAW The raw interrupt status of [SPI_MST_TX_AFIFO_EMPTY_ERR_INT](#) interrupt. (R/WTC/SS)

SPI_APP2_INT_RAW The raw interrupt status of [SPI_APP2_INT](#) interrupt. The value is only controlled by the application. (R/WTC)

SPI_APP1_INT_RAW The raw interrupt status of [SPI_APP1_INT](#) interrupt. The value is only controlled by the application. (R/WTC)

Register 27.20. SPI_DMA_INT_ST_REG (0x0040)

(reserved)																					Reset			
31	21	20	19	18	17	16	15	14	13	12	11	10	9	8	7	6	5	4	3	2	1	0		
0	0	0	0	0	0	0	0	0	0	0	0	0	0	0	0	0	0	0	0	0	0	0	0	0

SPI_DMA_INFIFO_FULL_ERR_INT_ST The interrupt status of [SPI_DMA_INFIFO_FULL_ERR_INT](#) interrupt. (RO)

SPI_DMA_OUTFIFO_EMPTY_ERR_INT_ST The interrupt status of [SPI_DMA_OUTFIFO_EMPTY_ERR_INT](#) interrupt. (RO)

SPI_SLV_EX_QPI_INT_ST The interrupt status of [SPI_SLV_EX_QPI_INT](#) interrupt. (RO)

SPI_SLV_EN_QPI_INT_ST The interrupt status of [SPI_SLV_EN_QPI_INT](#) interrupt. (RO)

SPI_SLV_CMD7_INT_ST The interrupt status of [SPI_SLV_CMD7_INT](#) interrupt. (RO)

SPI_SLV_CMD8_INT_ST The interrupt status of [SPI_SLV_CMD8_INT](#) interrupt. (RO)

SPI_SLV_CMD9_INT_ST The interrupt status of [SPI_SLV_CMD9_INT](#) interrupt. (RO)

SPI_SLV_CMDA_INT_ST The interrupt status of [SPI_SLV_CMDA_INT](#) interrupt. (RO)

SPI_SLV_RD_DMA_DONE_INT_ST The interrupt status of [SPI_SLV_RD_DMA_DONE_INT](#) interrupt. (RO)

SPI_SLV_WR_DMA_DONE_INT_ST The interrupt status of [SPI_SLV_WR_DMA_DONE_INT](#) interrupt. (RO)

SPI_SLV_RD_BUF_DONE_INT_ST The interrupt status of [SPI_SLV_RD_BUF_DONE_INT](#) interrupt. (RO)

SPI_SLV_WR_BUF_DONE_INT_ST The interrupt status of [SPI_SLV_WR_BUF_DONE_INT](#) interrupt. (RO)

SPI_TRANS_DONE_INT_ST The interrupt status of [SPI_TRANS_DONE_INT](#) interrupt. (RO)

SPI_DMA_SEG_TRANS_DONE_INT_ST The interrupt status of [SPI_DMA_SEG_TRANS_DONE_INT](#) interrupt. (RO)

SPI_SEG_MAGIC_ERR_INT_ST The interrupt status of [SPI_SEG_MAGIC_ERR_INT](#) interrupt. (RO)

SPI_SLV_CMD_ERR_INT_ST The interrupt status of [SPI_SLV_CMD_ERR_INT](#) interrupt. (RO)

Continued on the next page...

Register 27.20. SPI_DMA_INT_ST_REG (0x0040)

Continued from the previous page...

SPI_MST_RX_AFIFO_WFULL_ERR_INT_ST The interrupt status of [SPI_MST_RX_AFIFO_WFULL_ERR_INT](#) interrupt. (RO)

SPI_MST_TX_AFIFO_REMPTY_ERR_INT_ST The interrupt status of [SPI_MST_TX_AFIFO_REMPTY_ERR_INT](#) interrupt. (RO)

SPI_APP2_INT_ST The interrupt status of [SPI_APP2_INT](#) interrupt. (RO)

SPI_APP1_INT_ST The interrupt status of [SPI_APP1_INT](#) interrupt. (RO)

Register 27.21. SPI_DMA_INT_SET_REG (0x0044)

31	21	20	19	18	17	16	15	14	13	12	11	10	9	8	7	6	5	4	3	2	1	0	Reset
0	0	0	0	0	0	0	0	0	0	0	0	0	0	0	0	0	0	0	0	0	0	0	Reset

(reserved)
[SPI_APP1_INT_SET](#)
[SPI_APP2_INT_SET](#)
[SPI_MST_TX_AFIFO_REMPTY_ERR_INT_SET](#)
[SPI_MST_RX_AFIFO_WFULL_ERR_INT_SET](#)
(reserved)
[SPI_SEG_MAGIC_ERR_INT_SET](#)
[SPI_DMA_SEG_TRANS_DONE_INT_SET](#)
[SPI_TRANS_DONE_INT_SET](#)
[SPI_SLV_WR_BUF_DONE_INT_SET](#)
[SPI_SLV_RD_BUF_DONE_INT_SET](#)
[SPI_SLV_WR_DMA_DONE_INT_SET](#)
[SPI_SLV_RD_DMA_DONE_INT_SET](#)
[SPI_SLV_CMD9_INT_SET](#)
[SPI_SLV_CMD8_INT_SET](#)
[SPI_SLV_CMD7_INT_SET](#)
[SPI_SLV_EN_QPI_INT_SET](#)
[SPI_SLV_EX_QPI_INT_SET](#)
[SPI_DMA_OUTFIFO_EMPTY_ERR_INT_SET](#)
[SPI_DMA_INFIFO_FULL_ERR_INT_SET](#)

SPI_DMA_INFIFO_FULL_ERR_INT_SET Write 1 to set [SPI_DMA_INFIFO_FULL_ERR_INT](#) interrupt. (WT)

SPI_DMA_OUTFIFO_EMPTY_ERR_INT_SET Write 1 to set [SPI_DMA_OUTFIFO_EMPTY_ERR_INT](#) interrupt. (WT)

SPI_SLV_EX_QPI_INT_SET Write 1 to set [SPI_SLV_EX_QPI_INT](#) interrupt. (WT)

SPI_SLV_EN_QPI_INT_SET Write 1 to set [SPI_SLV_EN_QPI_INT](#) interrupt. (WT)

SPI_SLV_CMD7_INT_SET Write 1 to set [SPI_SLV_CMD7_INT](#) interrupt. (WT)

SPI_SLV_CMD8_INT_SET Write 1 to set [SPI_SLV_CMD8_INT](#) interrupt. (WT)

SPI_SLV_CMD9_INT_SET Write 1 to set [SPI_SLV_CMD9_INT](#) interrupt. (WT)

SPI_SLV_CMDA_INT_SET Write 1 to set [SPI_SLV_CMDA_INT](#) interrupt. (WT)

Continued on the next page...

Register 27.21. SPI_DMA_INT_SET_REG (0x0044)

Continued from the previous page...

SPI_SLV_RD_DMA_DONE_INT_SET Write 1 to set [SPI_SLV_RD_DMA_DONE_INT](#) interrupt. (WT)

SPI_SLV_WR_DMA_DONE_INT_SET Write 1 to set [SPI_SLV_WR_DMA_DONE_INT](#) interrupt. (WT)

SPI_SLV_RD_BUF_DONE_INT_SET Write 1 to set [SPI_SLV_RD_BUF_DONE_INT](#) interrupt. (WT)

SPI_SLV_WR_BUF_DONE_INT_SET Write 1 to set [SPI_SLV_WR_BUF_DONE_INT](#) interrupt. (WT)

SPI_TRANS_DONE_INT_SET Write 1 to set [SPI_TRANS_DONE_INT](#) interrupt. (WT)

SPI_DMA_SEG_TRANS_DONE_INT_SET Write 1 to set [SPI_DMA_SEG_TRANS_DONE_INT](#) interrupt. (WT)

SPI_SEG_MAGIC_ERR_INT_SET Write 1 to set [SPI_SEG_MAGIC_ERR_INT](#) interrupt. (WT)

SPI_SLV_CMD_ERR_INT_SET Write 1 to set [SPI_SLV_CMD_ERR_INT](#) interrupt. (WT)

SPI_MST_RX_AFIFO_WFULL_ERR_INT_SET Write 1 to set [SPI_MST_RX_AFIFO_WFULL_ERR_INT](#) interrupt. (WT)

SPI_MST_TX_AFIFO_REMPTY_ERR_INT_SET Write 1 to set [SPI_MST_TX_AFIFO_REMPTY_ERR_INT](#) interrupt. (WT)

SPI_APP2_INT_SET Write 1 to set [SPI_APP2_INT](#) interrupt. (WT)

SPI_APP1_INT_SET Write 1 to set [SPI_APP1_INT](#) interrupt. (WT)

Register 27.22. SPI_Wn_REG (n : 0-15) (0x0098 + 0x4*n)

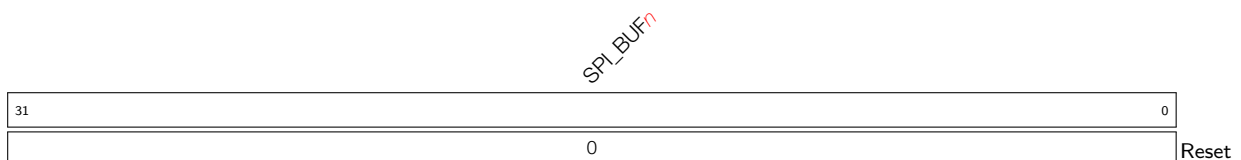

SPI_BUF n 32-bit data buffer n . (R/W/SS)

Register 27.23. SPI_DATE_REG (0x00F0)

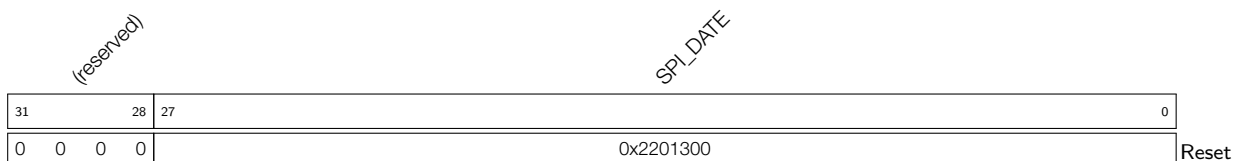

SPI_DATE Version control register. (R/W)

28 I2C Controller (I2C)

The I2C (Inter-Integrated Circuit) bus allows ESP32-C6 to communicate with multiple external devices. These external devices can share one I2C bus. ESP32-C6 has two I2C controllers: one in the main system and another one in the low-power system. The I2C controller in the main system can act as a master or a slave (referred to as I2C below). The I2C controller in the low-power system can only act as a master (referred to as LP_I2C below), and it can still work when the main system sleeps.

28.1 Overview

The I2C bus has two lines, namely a serial data line (SDA) and a serial clock line (SCL). Both SDA and SCL lines are open-drain. The I2C bus can be connected to a single or multiple master devices and a single or multiple slave devices. However, only one master device can access a slave at a time via the bus.

The master initiates communication by generating a START condition: pulling the SDA line low while SCL is high. Then it issues nine clock pulses via SCL. The first eight pulses are used to transmit a 7-bit address followed by a read/write (R/\overline{W}) bit. If the address of an I2C slave matches the 7-bit address transmitted, this matching slave can respond by pulling SDA low on the ninth clock pulse. The master and the slave can send or receive data according to the R/\overline{W} bit. Whether to terminate the data transfer or not is determined by the logic level of the acknowledge (ACK) bit. During data transfer, SDA changes only when SCL is low. Once the communication has finished, the master sends a STOP condition: pulling SDA up while SCL is high. If a master both reads and writes data in one transfer, then it should send a RSTART condition, a slave address and a R/\overline{W} bit before changing its operation. The RSTART condition is used to change the transfer direction and the mode of the devices (master mode or slave mode).

28.2 Features

The I2C controller of ESP32-C6 has the following features:

- Master mode and slave mode
- Communication between multiple masters and slaves
- Standard mode (100 Kbit/s)
- Fast mode (400 Kbit/s)
- 7-bit addressing and 10-bit addressing
- Continuous data transfer achieved by pulling SCL low in slave mode
- Programmable digital noise filtering
- Dual address mode, which uses slave address and slave memory or register address

28.3 I2C Architecture

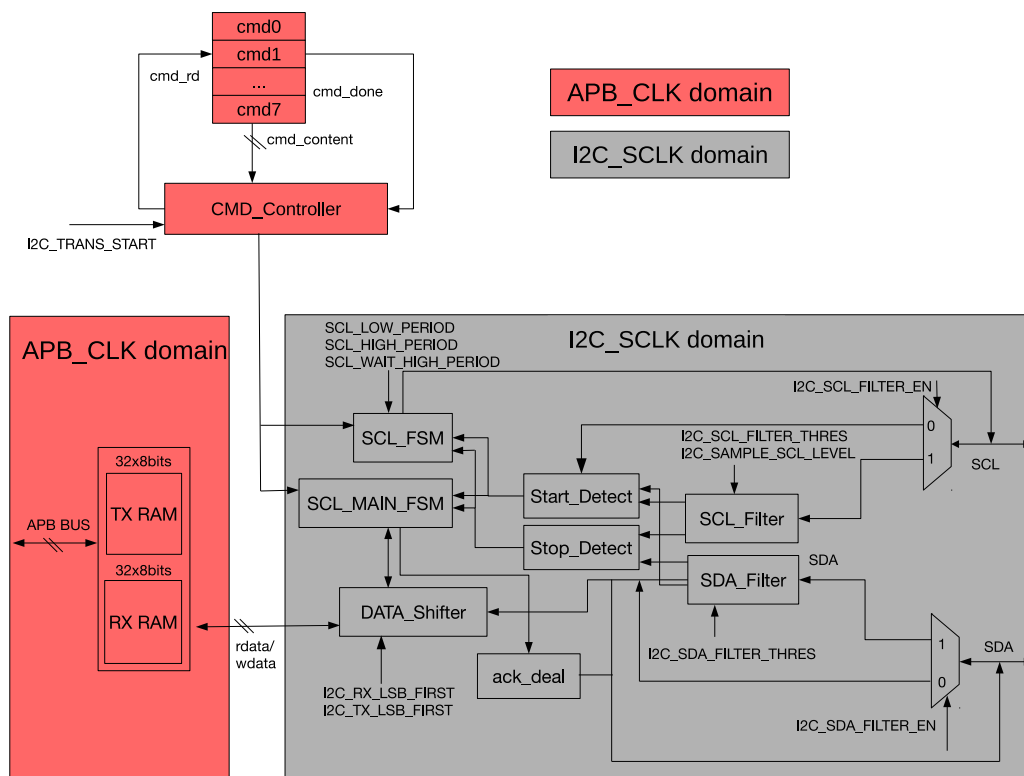

Figure 28-1. I2C Master Architecture

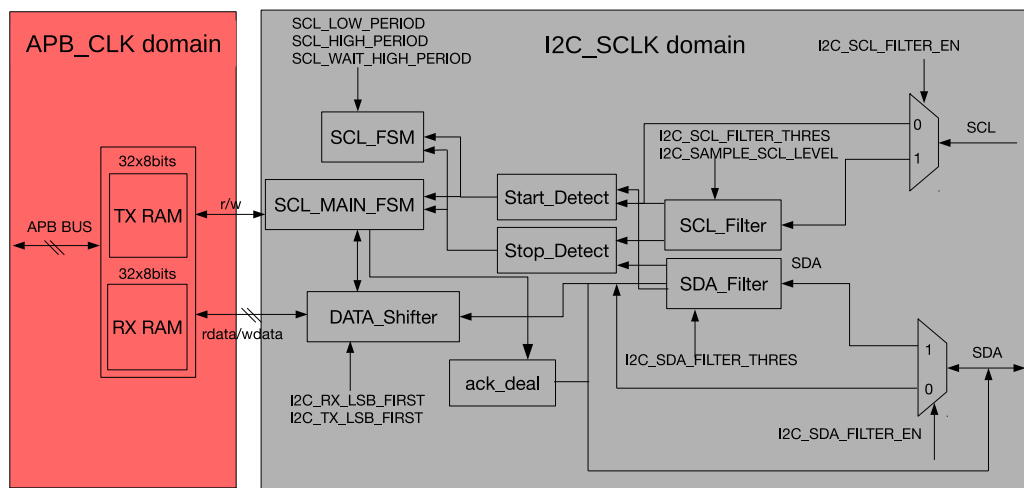

Figure 28-2. I2C Slave Architecture

The I2C controller runs either in master mode or slave mode, which is determined by *I2C_MS_MODE*. Figure 28-1 shows the architecture of a master, while Figure 28-2 shows that of a slave. The I2C controller has the following main parts:

- Transmit and receive memory (TX/RX RAM): store data to be transmitted and data received respectively.
- Command controller (CMD_Controller): generate (R)START, STOP, WRITE, READ and END commands
- SCL clock controller (SCL_FSM): generate the timing sequence conforming to the I2C protocol. Figure

28-3 and Figure 28-4 are the timing diagram and corresponding parameters of the I2C protocol.

- SDA data controller (SCL_MAIN_FSM): control the execution of I2C commands and the data sequence of the SDA line. It also controls the ACK_deal module to generate the ACK bit and detect the level of the ACK bit on the SDA line.
- Serial/parallel data converter (DATA_Shifter): shift data between serial and parallel form
- Filter for SCL (SCL_Filter): remove noises on SCL input signals
- Filter for SDA (SDA_Filter): remove noises on SDA input signals
- ACK bit controller (ack_deal): generate the ACK bit and detect the level of the ACK bit on the SDA line under the control of SCL_MAIN_FSM.

Besides, the I2C controller also has a clock module which generates I2C clocks, and a synchronization module which synchronizes the APB bus and the I2C controller.

The clock module is used to select clock sources, turn on and off clocks, and divide clocks. The synchronization module synchronizes signal transfer between different clock domains.

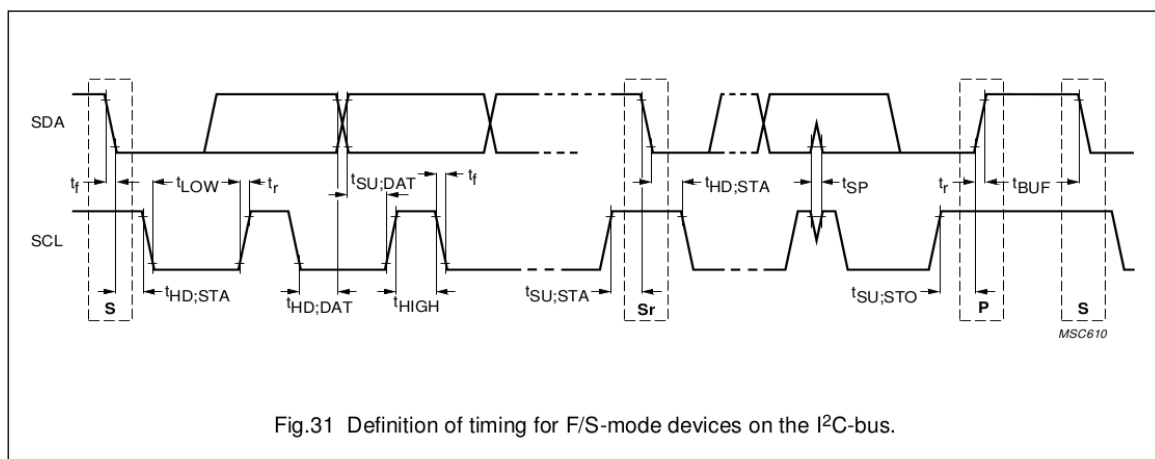

Figure 28-3. I2C Protocol Timing (Cited from Fig.31 in [The I2C-bus specification Version 2.1](#))

PARAMETER	SYMBOL	STANDARD-MODE		FAST-MODE		UNIT
		MIN.	MAX.	MIN.	MAX.	
SCL clock frequency	f _{SCL}	0	100	0	400	kHz
Hold time (repeated) START condition. After this period, the first clock pulse is generated	t _{HD;STA}	4.0	–	0.6	–	μs
LOW period of the SCL clock	t _{LOW}	4.7	–	1.3	–	μs
HIGH period of the SCL clock	t _{HIGH}	4.0	–	0.6	–	μs
Set-up time for a repeated START condition	t _{SU;STA}	4.7	–	0.6	–	μs
Data hold time: for CBUS compatible masters (see NOTE, Section 10.1.3) for I ² C-bus devices	t _{HD;DAT}	5.0 0 ⁽²⁾	– 3.45 ⁽³⁾	– 0 ⁽²⁾	– 0.9 ⁽³⁾	μs μs
Data set-up time	t _{SU;DAT}	250	–	100 ⁽⁴⁾	–	ns
Rise time of both SDA and SCL signals	t _r	–	1000	20 + 0.1C _b ⁽⁵⁾	300	ns
Fall time of both SDA and SCL signals	t _f	–	300	20 + 0.1C _b ⁽⁵⁾	300	ns
Set-up time for STOP condition	t _{SU;STO}	4.0	–	0.6	–	μs
Bus free time between a STOP and START condition	t _{BUF}	4.7	–	1.3	–	μs

Figure 28-4. I2C Timing Parameters (Cited from Table 5 in [The I2C-bus specification Version 2.1](#))

28.4 Functional Description

As mentioned above, one or more masters and one or more slaves can be connected on the I2C bus. The following sections describe the operations of the ESP32-C6 I2C controller. Note that operations may differ between the I2C controller in ESP32-C6 and other masters or slaves on the bus. Please refer to datasheets of individual I2C devices for specific information.

28.4.1 Clock Configuration

Registers, TX RAM, and RX RAM are configured and accessed in the APB_CLK clock domain. The main logic of the I2C controller, including SCL_FSM, SCL_MAIN_FSM, SCL_FILTER, SDA_FILTER, and DATA_SHIFTER, are in the I2C_SCLK clock domain.

You can choose the clock source for I2C_SCLK from XTAL_CLK or RC_FAST_CLK via [PCR_I2C_SCLK_SEL](#):

- Enable the clock source for I2C_SCLK by configuring [PCR_I2C_SCLK_EN](#) to 1.
- When [PCR_I2C_SCLK_SEL](#) is 0, the clock source is XTAL_CLK.
- When [PCR_I2C_SCLK_SEL](#) is 1, the clock source is RC_FAST_CLK.

The clock source then passes through a fractional divider to generate I2C_SCLK according to the following equation:

$$Divisor = PCR_I2C_SCLK_DIV_NUM + 1 + \frac{PCR_I2C_SCLK_DIV_A}{PCR_I2C_SCLK_DIV_B}$$

Limited by timing parameters, the derived clock I2C_SCLK should operate at a frequency 20 times larger than SCL's frequency.

28.4.2 SCL and SDA Noise Filtering

SCL_Filter and SDA_Filter modules are identical and are used to filter signal noise on SCL and SDA, respectively. These filters can be enabled or disabled by configuring [I2C_SCL_FILTER_EN](#) and [I2C_SDA_FILTER_EN](#).

Take SCL_Filter as an example. When enabled, SCL_Filter samples input signals on the SCL line continuously. These input signals are valid only if they remain unchanged for consecutive [I2C_SCL_FILTER_THRES](#) I2C_SCLK clock cycles. Given that only valid input signals can pass through the filter, SCL_Filter can remove glitches whose pulse width is shorter than [I2C_SCL_FILTER_THRES](#) I2C_SCLK clock cycles, while SDA_Filter can remove glitches whose pulse width is shorter than [I2C_SDA_FILTER_THRES](#) I2C_SCLK clock cycles.

28.4.3 SCL Clock Stretching

The I2C controller in slave mode (i.e. slave) can realize the function called clock stretching by holding the SCL line low to suspend data transmission in exchange for more time to process data. This function is enabled by setting the [I2C_SLAVE_SCL_STRETCH_EN](#) bit. The time period to release the SCL line from stretching is configured by setting the [I2C_STRETCH_PROTECT_NUM](#) field, in order to avoid timing sequence errors. The slave can choose to achieve clock stretching by holding the SCL line low when one of the following four events occurs:

1. Address match: The address of the slave matches the address sent by the master via the SDA line, and the R/\overline{W} bit is 1.
2. RAM being full: RX RAM of the slave is full. Note that when the slave receives less than the FIFO depth, which is 32 bytes in ESP32-C6 I2C, it is not necessary to enable clock stretching; when the slave receives FIFO depth bytes or more, you may interrupt data transmission to wrapped around RAM via the FIFO threshold, or enable clock stretching for more time to process data. When clock stretching is enabled, [I2C_RX_FULL_ACK_LEVEL](#) must be cleared, otherwise there will be unpredictable consequences.
3. RAM being empty: The slave is sending data, but its TX RAM is empty.
4. Sending an ACK: If [I2C_SLAVE_BYTE_ACK_CTL_EN](#) is set, the slave pulls SCL low when sending an ACK bit. At this stage, software validates data and configures [I2C_SLAVE_BYTE_ACK_LVL](#) to control the level of the ACK bit. Note that when RX RAM of the slave is full, the level of the ACK bit to be sent is determined by [I2C_RX_FULL_ACK_LEVEL](#), instead of [I2C_SLAVE_BYTE_ACK_LVL](#). In this case, [I2C_RX_FULL_ACK_LEVEL](#) should also be cleared to ensure proper functioning of clock stretching.

When clock stretching occurs, the cause of stretching can be read from the [I2C_STRETCH_CAUSE](#) bit. Clock stretching can be disabled by setting the [I2C_SLAVE_SCL_STRETCH_CLR](#) bit.

28.4.4 Generating SCL Pulses in Idle State

Usually when the I2C bus is idle, the SCL line is held high. The I2C controller in ESP32-C6 can be programmed to generate SCL pulses in idle state. This function only works when the I2C controller is configured as master. If the [I2C_SCL_RST_SLV_EN](#) bit is set, hardware will send [I2C_SCL_RST_SLV_NUM](#) SCL pulses, and then automatically clear [I2C_SCL_RST_SLV_EN](#) bit.

28.4.5 Synchronization

I2C registers are configured in APB_CLK domain, whereas the I2C controller is configured in asynchronous I2C_SCLK domain. Therefore, before being used by the I2C controller, register values should be synchronized by first writing configuration registers and then writing 1 to [I2C_CONF_UPGATE](#). Registers that need synchronization are listed in Table 28-1.

Table 28-1. I2C Synchronous Registers

Register	Field	Address
I2C_CTR_REG	I2C_SLV_TX_AUTO_START_EN	0x0004
	I2C_ADDR_10BIT_RW_CHECK_EN	
	I2C_ADDR_BROADCASTING_EN	
	I2C_SDA_FORCE_OUT	
	I2C_SCL_FORCE_OUT	
	I2C_SAMPLE_SCL_LEVEL	
	I2C_RX_FULL_ACK_LEVEL	
	I2C_MS_MODE	
	I2C_TX_LSB_FIRST	
	I2C_RX_LSB_FIRST	
	I2C_ARBITRATION_EN	
I2C_TO_REG	I2C_TIME_OUT_EN	0x000C
	I2C_TIME_OUT_VALUE	
I2C_SLAVE_ADDR_REG	I2C_ADDR_10BIT_EN	0x0010
	I2C_SLAVE_ADDR	
I2C_FIFO_CONF_REG	I2C_FIFO_ADDR_CFG_EN	0x0018
I2C_SCL_SP_CONF_REG	I2C_SDA_PD_EN	0x0080
	I2C_SCL_PD_EN	
	I2C_SCL_RST_SLV_NUM	
	I2C_SCL_RST_SLV_EN	
I2C_SCL_STRETCH_CONF_REG	I2C_SLAVE_BYTE_ACK_CTL_EN	0x0084
	I2C_SLAVE_BYTE_ACK_LVL	
	I2C_SLAVE_SCL_STRETCH_EN	
	I2C_STRETCH_PROTECT_NUM	
I2C_SCL_LOW_PERIOD_REG	I2C_SCL_LOW_PERIOD	0x0000
I2C_SCL_HIGH_PERIOD_REG	I2C_WAIT_HIGH_PERIOD	0x0038
	I2C_HIGH_PERIOD	
I2C_SDA_HOLD_REG	I2C_SDA_HOLD_TIME	0x0030
I2C_SDA_SAMPLE_REG	I2C_SDA_SAMPLE_TIME	0x0034
I2C_SCL_START_HOLD_REG	I2C_SCL_START_HOLD_TIME	0x0040
I2C_SCL_RSTART_SETUP_REG	I2C_SCL_RSTART_SETUP_TIME	0x0044
I2C_SCL_STOP_HOLD_REG	I2C_SCL_STOP_HOLD_TIME	0x0048
I2C_SCL_STOP_SETUP_REG	I2C_SCL_STOP_SETUP_TIME	0x004C
I2C_SCL_ST_TIME_OUT_REG	I2C_SCL_ST_TO_I2C	0x0078
I2C_SCL_MAIN_ST_TIME_OUT_REG	I2C_SCL_MAIN_ST_TO_I2C	0x007C
I2C_FILTER_CFG_REG	I2C_SCL_FILTER_EN	0x0050
	I2C_SCL_FILTER_THRES	
	I2C_SDA_FILTER_EN	
	I2C_SDA_FILTER_THRES	

28.4.6 Open-Drain Output

SCL and SDA output drivers must be configured as open-drain. There are two ways to achieve this:

1. Set `I2C_SCL_FORCE_OUT` and `I2C_SDA_FORCE_OUT`, and configure `GPIO_PIN n _PAD_DRIVER` for corresponding SCL and SDA pads as open-drain.
2. Clear `I2C_SCL_FORCE_OUT` and `I2C_SDA_FORCE_OUT`.

Because these lines are configured as open-drain, the low-to-high transition time of each line is longer, determined together by the pull-up resistor and line capacitance. The output duty cycle of I2C is limited by the SDA and SCL line's pull-up speed, mainly SCL's speed.

In addition, when `I2C_SCL_FORCE_OUT` and `I2C_SCL_PD_EN` are set to 1, SCL can be forced low; when `I2C_SDA_FORCE_OUT` and `I2C_SDA_PD_EN` are set to 1, SDA can be forced low.

28.4.7 Timing Parameter Configuration

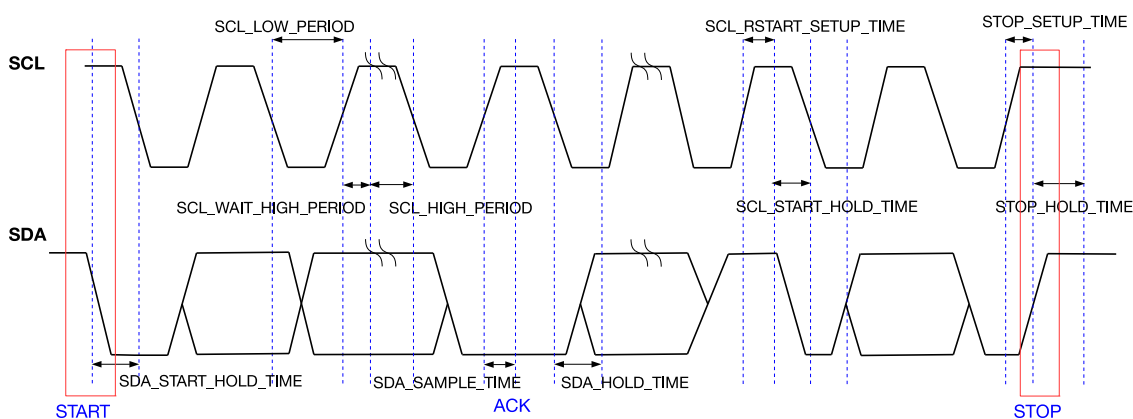

Figure 28-5. I2C Timing Diagram

Figure 28-5 shows the timing diagram of an I2C master. This figure also specifies registers used to configure the START bit, STOP bit, data hold time, data sample time, waiting time on the rising SCL edge, etc. Timing parameters are calculated as follows in `I2C_SCLK` clock cycles:

1. $t_{LOW} = (I2C_SCL_LOW_PERIOD + 1) \cdot T_{I2C_SCLK}$
2. $t_{HIGH} = (I2C_SCL_HIGH_PERIOD + 1) \cdot T_{I2C_SCLK}$
3. $t_{SU:STA} = (I2C_SCL_RSTART_SETUP_TIME + 1) \cdot T_{I2C_SCLK}$
4. $t_{HD:STA} = (I2C_SCL_START_HOLD_TIME + 1) \cdot T_{I2C_SCLK}$
5. $t_r = (I2C_SCL_WAIT_HIGH_PERIOD + 1) \cdot T_{I2C_SCLK}$
6. $t_{SU:STO} = (I2C_SCL_STOP_SETUP_TIME + 1) \cdot T_{I2C_SCLK}$
7. $t_{BUF} = (I2C_SCL_STOP_HOLD_TIME + 1) \cdot T_{I2C_SCLK}$
8. $t_{HD:DAT} = (I2C_SDA_HOLD_TIME + 1) \cdot T_{I2C_SCLK}$
9. $t_{SU:DAT} = (I2C_SCL_LOW_PERIOD - I2C_SDA_HOLD_TIME) \cdot T_{I2C_SCLK}$

Timing registers below are divided into two groups, depending on the mode in which these registers are active:

- Master mode only:

1. **I2C_SCL_START_HOLD_TIME**: Specifies the interval between the moment SDA is pulled low and the moment SCL is pulled low when the master generates a START condition. This interval is $(I2C_SCL_START_HOLD_TIME + 1)$ in I2C_SCLK cycles. This register is active only when the I2C controller works in master mode.
2. **I2C_SCL_LOW_PERIOD**: Specifies the low period of SCL. This period lasts $(I2C_SCL_LOW_PERIOD + 1)$ in I2C_SCLK cycles. This register is active only when the I2C controller works in master mode.

However, this period could be extended in the following scenarios:

- SCL is pulled low by peripheral devices when I2C acts as a master.
 - SCL is pulled low by an END command executed by the I2C controller.
 - SCL is pulled low by clock stretching when I2C acts as a slave.
3. **I2C_SCL_WAIT_HIGH_PERIOD**: Specifies time for SCL to switch from low to high in I2C_SCLK cycles. Please make sure that SCL can be pulled high within this time period. Otherwise, the high period of SCL may be incorrect. This register is active only when the I2C controller works in master mode.
 4. **I2C_SCL_HIGH_PERIOD**: Specifies the high period of SCL in I2C_SCLK cycles. This register is active only when the I2C controller works in master mode. When SCL goes high within $(I2C_SCL_WAIT_HIGH_PERIOD + 1)$ in I2C_SCLK cycles, its frequency is:

$$f_{scl} = \frac{f_{I2C_SCLK}}{I2C_SCL_LOW_PERIOD + I2C_SCL_HIGH_PERIOD + I2C_SCL_WAIT_HIGH_PERIOD + 3 + I2C_SCL_FILTER_THRES}$$

where 3 represents the amount of clock cycles required to synchronize the SCL. If the SCL filtering function is turned on, the delay caused by **I2C_SCL_FILTER_THRES** needs to be added. As the SCL low-to-high transition time represented by $I2C_SCL_WAIT_HIGH_PERIOD + 1$ module clock can be affected by the pull-up resistor, IO drive capability, SCL line capacitance, etc., deviation may occur between the actual frequency of the test and the theoretical frequency. At this point, deviations can be reduced by adjusting the value of **I2C_SCL_WAIT_HIGH_PERIOD**.

- Master mode and slave mode:

1. **I2C_SDA_SAMPLE_TIME**: Specifies the interval between the rising edge of SCL and the level sampling time of SDA. It is advised to set a value in the middle of SCL's high period, so as to correctly sample the level of SCL. This register is active both in master mode and slave mode.
2. **I2C_SDA_HOLD_TIME**: Specifies the interval between changing the SDA output level and the falling edge of SCL. This register is active both in master mode and slave mode.

Timing parameters limits corresponding register configuration.

1. $\frac{f_{I2C_SCLK}}{f_{SCL}} > 20$
2. $3 \times f_{I2C_SCLK} \leq (I2C_SDA_HOLD_TIME - 4) \times f_{APB_CLK}$
3. $I2C_SDA_HOLD_TIME + I2C_SCL_START_HOLD_TIME > SDA_FILTER_THRES + 3$
4. $I2C_SCL_WAIT_HIGH_PERIOD < I2C_SDA_SAMPLE_TIME < I2C_SCL_HIGH_PERIOD$
5. $I2C_SDA_SAMPLE_TIME < I2C_SCL_WAIT_HIGH_PERIOD + I2C_SCL_START_HOLD_TIME + I2C_SCL_RSTART_SETUP_TIME$
6. $I2C_STRETCH_PROTECT_NUM + I2C_SDA_HOLD_TIME > I2C_SCL_LOW_PERIOD$

28.4.8 Timeout Control

The I2C controller has three types of timeout control, namely timeout control for SCL_FSM, for SCL_MAIN_FSM, and for the SCL line. The first two are always enabled, while the third is configurable.

When SCL_FSM remains unchanged for more than $2^{I2C_SCL_ST_TO_I2C}$ clock cycles, an I2C_SCL_ST_TO_INT interrupt is triggered, and then SCL_FSM goes to idle state. The value of I2C_SCL_ST_TO_I2C should be less than or equal to 22, which means SCL_FSM could remain unchanged for 2^{22} I2C_SCLK clock cycles at most before the interrupt is generated.

When SCL_MAIN_FSM remains unchanged for more than $2^{I2C_SCL_MAIN_ST_TO_I2C}$ I2C_SCLK clock cycles, an I2C_SCL_MAIN_ST_TO_INT interrupt is triggered, and then SCL_MAIN_FSM goes to idle state. The value of I2C_SCL_MAIN_ST_TO_I2C should be less than or equal to 22, which means SCL_MAIN_FSM could remain unchanged for 2^{22} clock cycles at most before the interrupt is generated.

Timeout control for SCL is enabled by setting I2C_TIME_OUT_EN. When the level of SCL remains unchanged for more than I2C_TIME_OUT_VALUE clock cycles, an I2C_TIME_OUT_INT interrupt is triggered, and then the I2C bus goes to idle state.

28.4.9 Command Configuration

When the I2C controller works in master mode, CMD_Controller reads commands from 8 sequential command registers and controls SCL_FSM and SCL_MAIN_FSM accordingly.

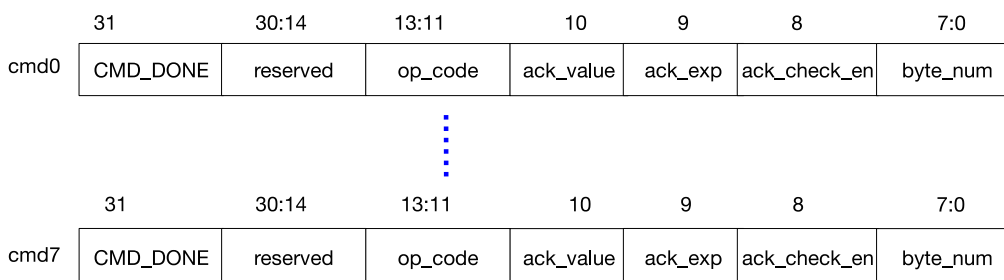

Figure 28-6. Structure of I2C Command Registers

Command registers, whose structure is illustrated in Figure 28-6, are active only when the I2C controller works in master mode. Fields of command registers are:

1. CMD_DONE: Indicates that a command has been executed. After each command has been executed, the CMD_DONE bit in the corresponding command register is set to 1 by hardware. By reading this bit, software can tell if the command has been executed. When writing new commands, this bit must be cleared by software.
2. op_code: Indicates the command. The I2C controller supports five commands:
 - WRITE: op_code = 1. The I2C controller sends a slave address, a register address (only in dual address mode) and data to the slave.
 - STOP: op_code = 2. The I2C controller sends a STOP bit defined by the I2C protocol. This code also indicates that the command sequence has been executed, and the CMD_Controller stops reading commands. After restarted by software, the CMD_Controller resumes reading commands from command register 0.

- READ: `op_code = 3`. The I2C controller reads data from the slave.
 - END: `op_code = 4`. The I2C controller pulls the SCL line down and suspends I2C communication. This code also indicates that the command sequence has completed, and the `CMD_Controller` stops executing commands. Once software refreshes data in command registers and the RAM, the `CMD_Controller` can be restarted to execute commands from command register 0 again.
 - RSTART: `op_code = 6`. The I2C controller sends a START bit or a RSTART bit defined by the I2C protocol.
3. `ack_value`: Used to configure the level of the ACK bit sent by the I2C controller during a read operation. This bit is ignored in RSTART, STOP, END and WRITE conditions.
 4. `ack_exp`: Used to configure the level of the ACK bit expected by the I2C controller during a write operation. This bit is ignored during RSTART, STOP, END and READ conditions.
 5. `ack_check_en`: Used to enable the I2C controller during a write operation to check whether the ACK level sent by the slave matches `ack_exp` in the command. If this bit is set and the level received does not match `ack_exp` in the WRITE command, the master will generate an `I2C_NACK_INT` interrupt and a STOP condition for data transfer. If this bit is cleared, the controller will not check the ACK level sent by the slave. This bit is ignored during RSTART, STOP, END and READ conditions.
 6. `byte_num`: Specifies the length of data (in bytes) to be read or written. Can range from 1 to 255 bytes. This bit is ignored during RSTART, STOP and END conditions.

Each command sequence is executed starting from command register 0 and terminated by a STOP or an END. Therefore, there must be a STOP or an END command in the eight command registers.

A complete data transfer on the I2C bus should be initiated by a START and terminated by a STOP. The transfer process may be completed using multiple sequences, separated by END commands. Each sequence may differ in the direction of data transfer, clock frequency, slave addresses, data length, etc. This allows efficient use of available peripheral RAM and also achieves more flexible I2C communication.

28.4.10 TX/RX RAM Data Storage

Both TX RAM and RX RAM are 32×8 bits, and can be accessed in FIFO or non-FIFO mode. If `I2C_NONFIFO_EN` bit is cleared, both RAMs are accessed in FIFO mode; if `I2C_NONFIFO_EN` bit is set, both RAMs are accessed in non-FIFO mode.

TX RAM stores data that the I2C controller needs to send. During communication, when the I2C controller needs to send data (except acknowledgement bits), it reads data from TX RAM and sends them sequentially via SDA. When the I2C controller works in master mode, all data must be stored in TX RAM in the order they need to be sent to slaves. The data stored in TX RAM include slave addresses, read/write bits, register addresses (only in dual address mode) and data to be sent. When the I2C controller works in slave mode, TX RAM only stores data to be sent.

TX RAM can be read and written by the CPU. The CPU writes to TX RAM either in FIFO mode or in non-FIFO mode (direct address). In FIFO mode, the CPU writes to TX RAM via the fixed address `I2C_DATA_REG`, with addresses for writing in TX RAM incremented automatically by hardware. In non-FIFO mode, the CPU accesses TX RAM directly via address fields (`I2C Base Address + 0x100`) ~ (`I2C Base Address + 0x17C`). Each byte in TX RAM occupies an entire word in the address space. Therefore, the address of the first byte is `I2C Base Address + 0x100`, the second byte is `I2C Base Address + 0x104`, the third byte is `I2C Base Address + 0x108`, and so on.

The CPU can only read TX RAM via direct addresses. Bytes written to the TX RAM can be read back by the CPU, via the direct addresses. Addresses for reading TX RAM are the same with addresses for writing TX RAM.

RX RAM stores data the I2C controller receives during communication. When the I2C controller works in slave mode, neither slave addresses sent by the master nor register addresses (only in dual address mode) will be stored into RX RAM. Values of RX RAM can be read by software after I2C communication completes.

RX RAM can only be read by the CPU. The CPU reads RX RAM either in FIFO mode or in non-FIFO mode (direct address). In FIFO mode, the CPU reads RX RAM via the fixed address [I2C_DATA_REG](#), with addresses for reading RX RAM incremented automatically by hardware. In non-FIFO mode, the CPU accesses TX RAM directly via address fields ([I2C Base Address](#) + 0x180) ~([I2C Base Address](#) + 0x1FC). Each byte in RX RAM occupies an entire word in the address space. Therefore, the address of the first byte is [I2C Base Address](#) + 0x180, the second byte is [I2C Base Address](#) + 0x184, the third byte is [I2C Base Address](#) + 0x188 and so on.

In FIFO mode, TX RAM of a master may wrap around to send data larger than the FIFO depth. Set [I2C_FIFO_PRT_EN](#). If the size of data to be sent is smaller than [I2C_TXFIFO_WM_THRHD](#) (master), an [I2C_TXFIFO_WM_INT](#) (master) interrupt is generated. After receiving the interrupt, software continues writing to [I2C_DATA_REG](#) (master). Please ensure that software writes to or refreshes TX RAM before the master sends data, otherwise it may result in unpredictable consequences.

In FIFO mode, RX RAM of a slave may also wrap around to receive data larger than the FIFO depth. Set [I2C_FIFO_PRT_EN](#) and clear [I2C_RX_FULL_ACK_LEVEL](#). If data already received (to be overwritten) is larger than [I2C_RXFIFO_WM_THRHD](#) (slave), an [I2C_RXFIFO_WM_INT](#) (slave) interrupt is generated. After receiving the interrupt, software continues reading from [I2C_DATA_REG](#) (slave).

28.4.11 Data Conversion

DATA_Shifter is used for serial/parallel conversion, converting byte data in TX RAM to an outgoing serial bitstream or an incoming serial bitstream to byte data in RX RAM. [I2C_RX_LSB_FIRST](#) and [I2C_TX_LSB_FIRST](#) can be used to select LSB- or MSB-first storage and transmission of data.

28.4.12 Addressing Mode

The ESP32-C6 I2C controller supports 7-bit and 10-bit addressing. 10-bit addressing can be mixed with 7-bit addressing. Besides, the ESP32-C6 I2C controller also supports dual address mode.

Define the slave address as SLV_ADDR. In 7-bit addressing mode, the slave address is SLV_ADDR[6:0]; in 10-bit addressing mode, the slave address is SLV_ADDR[9:0].

In 7-bit addressing mode, the master only needs to send one byte of address, which comprises SLV_ADDR[6:0] and a R/\overline{W} bit. In 7-bit addressing mode, there is a special case called general call addressing (broadcast). It is enabled by setting [I2C_ADDR_BROADCASTING_EN](#) in a slave. When the slave receives the general call address (0x00) from the master and the R/\overline{W} bit followed is 0, it responds to the master regardless of its own address.

In 10-bit addressing mode, the master needs to send two bytes of address. The first byte is slave_addr_first_7bits followed by a R/\overline{W} bit, and slave_addr_first_7bits should be configured as (0x78 | SLV_ADDR[9:8]). The second byte is slave_addr_second_byte, which should be configured as SLV_ADDR[7:0].

The slave can enable 10-bit addressing by configuring [I2C_ADDR_10BIT_EN](#). [I2C_SLAVE_ADDR](#) is used to configure I2C slave address. Specifically, [I2C_SLAVE_ADDR](#)[14:7] should be configured as SLV_ADDR[7:0], and

`I2C_SLAVE_ADDR[6:0]` should be configured as $(0x78 \mid \text{SLV_ADDR}[9:8])$. Since a 10-bit slave address has one more byte than a 7-bit address, `byte_num` of the WRITE command and the number of bytes in the RAM increase by one. Please refer to [Programming Example](#) for detailed descriptions.

When working in slave mode, the I2C controller supports dual address mode, where the first address is the address of an I2C slave, and the second one is the slave's memory address. When using dual address mode, RAM must be accessed in non-FIFO mode. Dual address mode is enabled by setting `I2C_FIFO_ADDR_CFG_EN`. When the slave address received by the slave is inconsistent with the internally configured slave address, the `I2C_SLAVE_ADDR_UNMATCH` interrupt will be generated.

28.4.13 R/\overline{W} Bit Check in 10-bit Addressing Mode

In 10-bit addressing mode, when `I2C_ADDR_10BIT_RW_CHECK_EN` is set to 1, the I2C controller performs a check on the first byte, which consists of `slave_addr_first_7bits` and a R/\overline{W} bit. When the R/\overline{W} bit does not indicate a WRITE operation, i.e. not in line with the I2C protocol, the data transfer ends. If the check feature is not enabled, when the R/\overline{W} bit does not indicate a WRITE, the data transfer still continues, but transfer failure may occur.

28.4.14 To Start the I2C Controller

To start the I2C controller in master mode, after configuring the controller to master mode and command registers, write 1 to `I2C_TRANS_START` in order to let the master starts to parse and execute command sequences. The master always executes a command sequence starting from command register 0 to a STOP or an END. To execute another command sequence starting from command register 0, refresh commands by writing 1 again to `I2C_TRANS_START`.

There are two ways to start the I2C controller in slave mode:

- Set `I2C_SLV_TX_AUTO_START_EN`, and the slave starts automatic transfer upon an address match;
- Clear `I2C_SLV_TX_AUTO_START_EN`, and always set `I2C_TRANS_START` before accepting any transfer.

28.5 Functional differences between LP_I2C and I2C

LP_I2C can be used as a master to communicate with external devices when the main system sleeps. LP_I2C includes all the functions of the ESP32-C6 `I2Cmaster`, but doesn't include any functions of ESP32-C6 `I2Cslave`. It does not contain any registers related to the `I2Cslave`. For detailed register list, see [28.10 LP_I2C Register Summary](#).

The design differences between LP_I2C and I2C master are as follows:

- The size of TX/RX RAM in LP_I2C is 16*8 bit, which means the TX RX FIFO depth is 16 bytes.
- The clock source of APB_CLK in LP_I2C is CLK_AON_FAST. Configure `LP_I2C_SCLK_SEL` to select the clock source for `I2C_SCLK`. When `LP_I2C_SCLK_SEL` is 0, select `CLK_ROOT_FAST` as clock source, and when `LP_I2C_SCLK_SEL` is 1, select `CLK_XTALD2` as the clock source. Configure `LP_EXT_I2C_CK_EN` high to enable the clock source of `I2C_SCLK`. Adjust the timing registers accordingly when the clock frequency changes.

See the programming examples of ESP32-C6 `I2Cslave` in [28.6](#) for that of LP_I2C.

28.6 Programming Example

This sections provides programming examples for typical communication scenarios. ESP32-C6 has two I2C controllers. For the convenience of description, I2C masters and slaves in all subsequent figures are ESP32-C6 I2C controllers. I2C master is referred to as I2C_{master}, and I2C slave is referred to as I2C_{slave}.

28.6.1 I2C_{master} Writes to I2C_{slave} with a 7-bit Address in One Command Sequence

28.6.1.1 Introduction

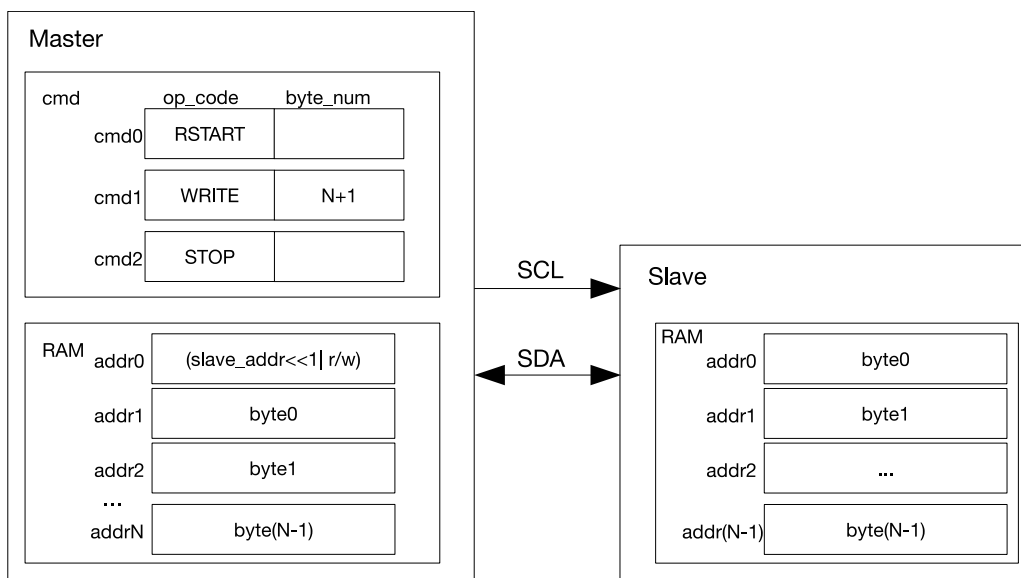

Figure 28-7. I2C_{master} Writing to I2C_{slave} with a 7-bit Address

Figure 28-7 shows how I2C_{master} writes N bytes of data to I2C_{slave} registers or RAM using 7-bit addressing. As shown in figure 28-7, the first byte in the RAM of I2C_{master} is a 7-bit I2C_{slave} address followed by a R/\overline{W} bit. When the R/\overline{W} bit is 0, it indicates a WRITE operation. The remaining bytes are used to store data ready for transfer. The cmd box contains related command sequences.

After the command sequence is configured and data in RAM is ready, I2C_{master} enables the controller and initiates data transfer by setting the `I2C_TRANS_START` bit. The controller has four steps to take:

1. Wait for SCL to go high, to avoid SCL being used by other masters or slaves.
2. Execute a RSTART command by sending a START bit.
3. Execute a WRITE command by taking N+1 bytes from the RAM in order and send them to I2C_{slave} in the same order. The first byte is the address of I2C_{slave}.
4. Execute a STOP command. Once the I2C_{master} transfers a STOP bit, an `I2C_TRANS_COMPLETE_INT` interrupt is generated.

28.6.1.2 Configuration Example

1. Configure the timing parameter registers of I2C_{master} and I2C_{slave} according to Section 28.4.7.
2. Set `I2C_MS_MODE` (master) to 1, and `I2C_MS_MODE` (slave) to 0.

3. Write 1 to [I2C_CONF_UPGATE](#) (master) and [I2C_CONF_UPGATE](#) (slave) to synchronize registers.
4. Configure command registers of $I2C_{\text{master}}$.

Command register	op_code	ack_value	ack_exp	ack_check_en	byte_num
I2C_COMMAND0 (master)	RSTART	—	—	—	—
I2C_COMMAND1 (master)	WRITE	ack_value	ack_exp	1	N+1
I2C_COMMAND2 (master)	STOP	—	—	—	—

5. Write the address of $I2C_{\text{slave}}$ and data to be sent to TX RAM of $I2C_{\text{master}}$ in either FIFO mode or non-FIFO mode according to Section [28.4.10](#).
6. Write the address of $I2C_{\text{slave}}$ to [I2C_SLAVE_ADDR](#) (slave) in [I2C_SLAVE_ADDR_REG](#) (slave) register.
7. Write 1 to [I2C_CONF_UPGATE](#) (master) and [I2C_CONF_UPGATE](#) (slave) to synchronize registers.
8. Write 1 to [I2C_TRANS_START](#) (master) and [I2C_TRANS_START](#) (slave) to start transfer.
9. $I2C_{\text{slave}}$ compares the slave address sent by $I2C_{\text{master}}$ with its own address in [I2C_SLAVE_ADDR](#) (slave). When [ack_check_en](#) (master) in $I2C_{\text{master}}$'s WRITE command is 1, $I2C_{\text{master}}$ checks ACK value each time it sends a byte. When [ack_check_en](#) (master) is 0, $I2C_{\text{master}}$ does not check ACK value and take $I2C_{\text{slave}}$ as a matching slave by default.
 - Match: If the received ACK value matches [ack_exp](#) (master) (the expected ACK value), $I2C_{\text{master}}$ continues data transfer.
 - Not match: If the received ACK value does not match [ack_exp](#), $I2C_{\text{master}}$ generates an [I2C_NACK_INT](#) (master) interrupt and stops data transfer.
10. $I2C_{\text{master}}$ sends data, and determines whether to check ACK value according to [ack_check_en](#) (master).
11. If data to be sent (N) is larger than TX FIFO depth, TX RAM of $I2C_{\text{master}}$ may wrap around in FIFO mode. For details, please refer to Section [28.4.10](#).
12. If data to be received (N) is larger than RX FIFO depth, RX RAM of $I2C_{\text{slave}}$ may wrap around in FIFO mode. For details, please refer to Section [28.4.10](#).

If data to be received (N) is larger than RX FIFO depth, the other way is to enable clock stretching by setting the [I2C_SLAVE_SCL_STRETCH_EN](#) (slave), and clearing [I2C_RX_FULL_ACK_LEVEL](#). When RX RAM is full, an [I2C_SLAVE_STRETCH_INT](#) (slave) interrupt is generated. In this way, $I2C_{\text{slave}}$ can hold SCL low, in exchange for more time to read data. After software has finished reading, you can set [I2C_SLAVE_STRETCH_INT_CLR](#) (slave) to 1 to clear interrupt, and set [I2C_SLAVE_SCL_STRETCH_CLR](#) (slave) to release the SCL line.
13. After data transfer completes, $I2C_{\text{master}}$ executes the STOP command, and generates an [I2C_TRANS_COMPLETE_INT](#) (master) interrupt.

28.6.2 $I2C_{\text{master}}$ Writes to $I2C_{\text{slave}}$ with a 10-bit Address in One Command Sequence

28.6.2.1 Introduction

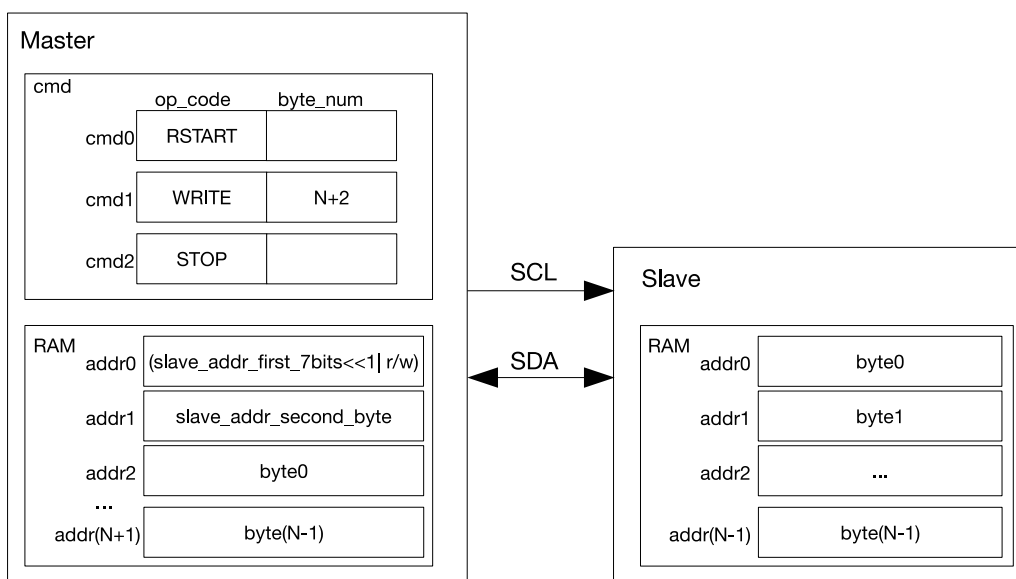

Figure 28-8. I2C_{master} Writing to a Slave with a 10-bit Address

Figure 28-8 shows how I2C_{master} writes N bytes of data using 10-bit addressing to an I2C slave. The configuration and transfer process is similar to what is described in 28.6.1, except that a 10-bit I2C_{slave} address is formed from two bytes. Since a 10-bit I2C_{slave} address has one more byte than a 7-bit I2C_{slave} address, byte_num and length of data in TX RAM increase by 1 accordingly.

28.6.2.2 Configuration Example

1. Set I2C_MS_MODE (master) to 1, and I2C_MS_MODE (slave) to 0.
2. Write 1 to I2C_CONF_UPGATE (master) and I2C_CONF_UPGATE (slave) to synchronize registers.
3. Configure command registers of I2C_{master}.

Command registers	op_code	ack_value	ack_exp	ack_check_en	byte_num
I2C_COMMAND0 (master)	RSTART	—	—	—	—
I2C_COMMAND1 (master)	WRITE	ack_value	ack_exp	1	N+2
I2C_COMMAND2 (master)	STOP	—	—	—	—

4. Configure I2C_SLAVE_ADDR (slave) in I2C_SLAVE_ADDR_REG (slave) as I2C_{slave}'s 10-bit address, and set I2C_ADDR_10BIT_EN (slave) to 1 to enable 10-bit addressing.
5. Write the address of I2C_{slave} and data to be sent to TX RAM of I2C_{master}. The first byte of the address of I2C_{slave} comprises ((0x78 | I2C_SLAVE_ADDR[9:8]) << 1) and a R/\overline{W} bit. The second byte of the address of I2C_{slave} is I2C_SLAVE_ADDR[7:0]. These two bytes are followed by data to be sent in FIFO or non-FIFO mode.
6. Write 1 to I2C_CONF_UPGATE (master) and I2C_CONF_UPGATE (slave) to synchronize registers.
7. Write 1 to I2C_TRANS_START (master) and I2C_TRANS_START (slave) to start transfer.
8. I2C_{slave} compares the slave address sent by I2C_{master} with its own address in I2C_SLAVE_ADDR (slave).

When `ack_check_en` (master) in $I2C_{\text{master}}$'s WRITE command is 1, $I2C_{\text{master}}$ checks ACK value each time it sends a byte. When `ack_check_en` (master) is 0, $I2C_{\text{master}}$ does not check ACK value and take $I2C_{\text{slave}}$ as matching slave by default.

- Match: If the received ACK value matches `ack_exp` (master) (the expected ACK value), $I2C_{\text{master}}$ continues data transfer.
- Not match: If the received ACK value does not match `ack_exp`, $I2C_{\text{master}}$ generates an `I2C_NACK_INT` (master) interrupt and stops data transfer.

- $I2C_{\text{master}}$ sends data, and determines whether to check ACK value according to `ack_check_en` (master).
- If data to be sent is larger than TX FIFO depth, TX RAM of $I2C_{\text{master}}$ may wrap around in FIFO mode. For details, please refer to Section 28.4.10.
- If data to be received is larger than RX FIFO depth, RX RAM of $I2C_{\text{slave}}$ may wrap around in FIFO mode. For details, please refer to Section 28.4.10.

If data to be received is larger than RX FIFO depth, the other way is to enable clock stretching by setting `I2C_SLAVE_SCL_STRETCH_EN` (slave), and clearing `I2C_RX_FULL_ACK_LEVEL` to 0. When RX RAM is full, an `I2C_SLAVE_STRETCH_INT` (slave) interrupt is generated. In this way, $I2C_{\text{slave}}$ can hold SCL low, in exchange for more time to read data. After software has finished reading, you can set `I2C_SLAVE_STRETCH_INT_CLR` (slave) to 1 to clear interrupt, and set `I2C_SLAVE_SCL_STRETCH_CLR` (slave) to release the SCL line.

- After data transfer completes, $I2C_{\text{master}}$ executes the STOP command, and generates an `I2C_TRANS_COMPLETE_INT` (master) interrupt.

28.6.3 $I2C_{\text{master}}$ Writes to $I2C_{\text{slave}}$ with Two 7-bit Addresses in One Command Sequence

28.6.3.1 Introduction

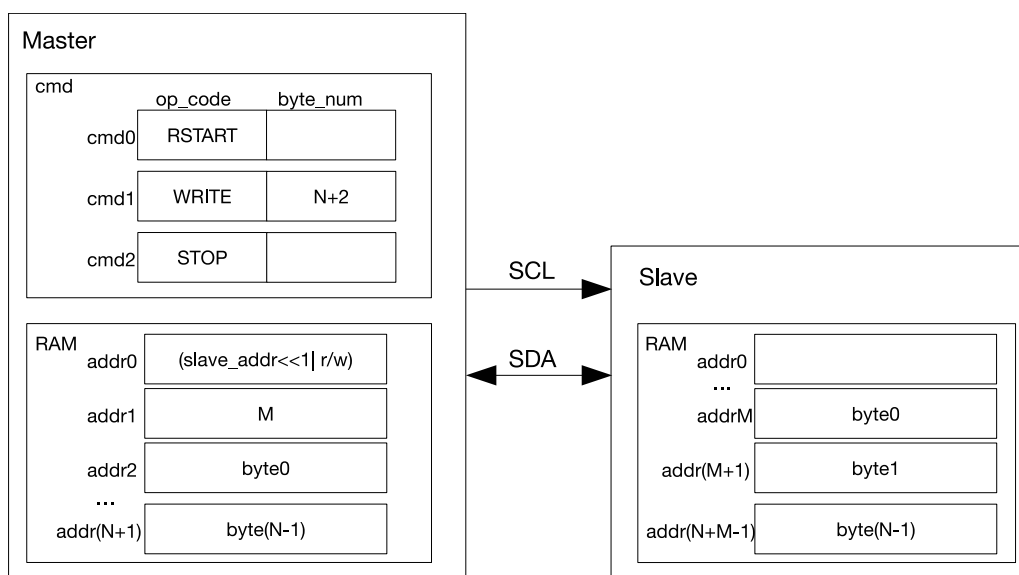

Figure 28-9. $I2C_{\text{master}}$ Writing to $I2C_{\text{slave}}$ with Two 7-bit Addresses

Figure 28-9 shows how $I2C_{\text{master}}$ writes N bytes of data to $I2C_{\text{slave}}$ registers or RAM using 7-bit double addressing. The configuration and transfer process is similar to what is described in Section 28.6.1, except that

in 7-bit dual address mode $I2C_{\text{master}}$ sends two 7-bit addresses. The first address is the address of an I2C slave, and the second one is $I2C_{\text{slave}}$'s memory address (i.e. addrM in Figure 28-9). When using double addressing, RAM must be accessed in non-FIFO mode. The I2C slave put received byte0 ~ byte(N-1) into its RAM in an order starting from addrM . The RAM is overwritten every 32 bytes.

28.6.3.2 Configuration Example

1. Set `I2C_MS_MODE` (master) to 1, and `I2C_MS_MODE` (slave) to 0.
2. Set `I2C_FIFO_ADDR_CFG_EN` (slave) to 1 to enable dual address mode.
3. Write 1 to `I2C_CONF_UPGATE` (master) and `I2C_CONF_UPGATE` (slave) to synchronize registers.
4. Configure command registers of $I2C_{\text{master}}$.

Command registers	op_code	ack_value	ack_exp	ack_check_en	byte_num
<code>I2C_COMMAND0</code> (master)	RSTART	—	—	—	—
<code>I2C_COMMAND1</code> (master)	WRITE	ack_value	ack_exp	1	N+2
<code>I2C_COMMAND2</code> (master)	STOP	—	—	—	—

5. Write the address of $I2C_{\text{slave}}$ and data to be sent to TX RAM of $I2C_{\text{master}}$ in FIFO or non-FIFO mode.
6. Write the address of $I2C_{\text{slave}}$ to `I2C_SLAVE_ADDR` (slave) in `I2C_SLAVE_ADDR_REG` (slave) register.
7. Write 1 to `I2C_CONF_UPGATE` (master) and `I2C_CONF_UPGATE` (slave) to synchronize registers.
8. Write 1 to `I2C_TRANS_START` (master) and `I2C_TRANS_START` (slave) to start transfer.
9. $I2C_{\text{slave}}$ compares the slave address sent by $I2C_{\text{master}}$ with its own address in `I2C_SLAVE_ADDR` (slave). When `ack_check_en` (master) in $I2C_{\text{master}}$'s WRITE command is 1, $I2C_{\text{master}}$ checks ACK value each time it sends a byte. When `ack_check_en` (master) is 0, $I2C_{\text{master}}$ does not check ACK value and take $I2C_{\text{slave}}$ as matching slave by default.
 - Match: If the received ACK value matches `ack_exp` (master) (the expected ACK value), $I2C_{\text{master}}$ continues data transfer.
 - Not match: If the received ACK value does not match `ack_exp`, $I2C_{\text{master}}$ generates an `I2C_NACK_INT` (master) interrupt and stops data transfer.
10. $I2C_{\text{slave}}$ receives the RX RAM address sent by $I2C_{\text{master}}$ and adds the offset.
11. $I2C_{\text{master}}$ sends data, and determines whether to check ACK value according to `ack_check_en` (master).
12. If data to be sent is larger than TX FIFO depth, TX RAM of $I2C_{\text{master}}$ may wrap around in FIFO mode. For details, please refer to Section 28.4.10.
13. If data to be received is larger than RX FIFO depth, you may enable clock stretching by setting `I2C_SLAVE_SCL_STRETCH_EN` (slave), and clearing `I2C_RX_FULL_ACK_LEVEL` to 0. When RX RAM is full, an `I2C_SLAVE_STRETCH_INT` (slave) interrupt is generated. In this way, $I2C_{\text{slave}}$ can hold SCL low, in exchange for more time to read data. After software has finished reading, you can set `I2C_SLAVE_STRETCH_INT_CLR` (slave) to 1 to clear interrupt, and set `I2C_SLAVE_SCL_STRETCH_CLR` (slave) to release the SCL line.
14. After data transfer completes, $I2C_{\text{master}}$ executes the STOP command, and generates an `I2C_TRANS_COMPLETE_INT` (master) interrupt.

PRELIMINARY

28.6.4 I2C_{master} Writes to I2C_{slave} with a 7-bit Address in Multiple Command Sequences

28.6.4.1 Introduction

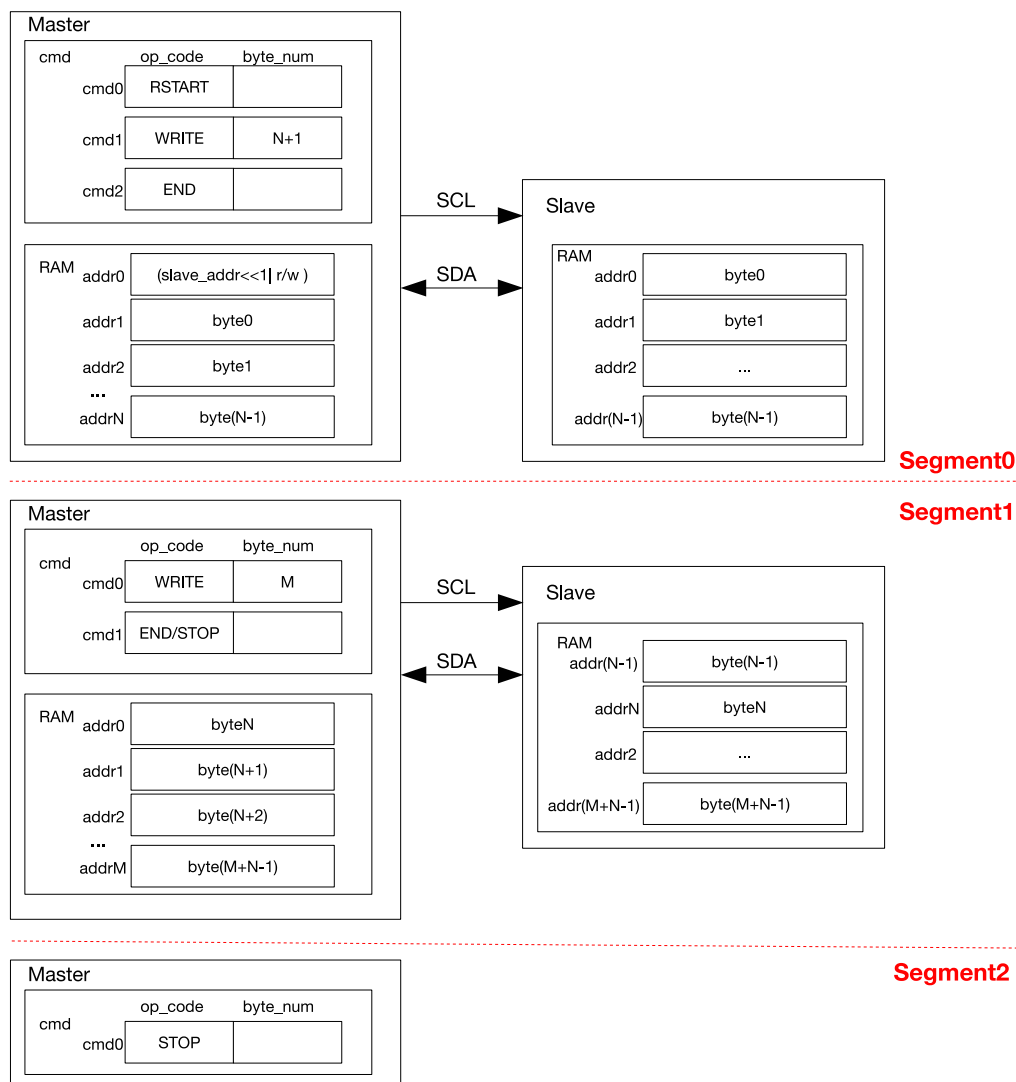

Figure 28-10. I2C_{master} Writing to I2C_{slave} with a 7-bit Address in Multiple Sequences

Given that the I2C Controller RAM holds only the size of TX/RX FIFO depth, when data are too large to be processed, it is advised to transmit them in multiple command sequences. At the end of every command sequence is an END command. When the controller executes this END command, SCL will be pulled low, and the software can refresh command sequence registers and the RAM for next the transfer.

Figure 28-10 shows how I2C_{master} writes to an I2C slave in two or three segments as an example. For the first segment, the CMD_Controller registers are configured as shown in Segment0. Once data in I2C_{master}'s RAM is ready and I2C_TRANS_START is set, I2C_{master} initiates data transfer. After executing the END command, I2C_{master} turns off the SCL clock and pulls SCL low to reserve the bus. Meanwhile, the controller generates an I2C_END_DETECT_INT interrupt.

For the second segment, after detecting the I2C_END_DETECT_INT interrupt, software refreshes the CMD_Controller registers, reloads the RAM and clears this interrupt, as shown in Segment1. If cmd1 in the second segment is a STOP, then data is transmitted to I2C_{slave} in two segments. I2C_{master} resumes data transfer

after [I2C_TRANS_START](#) is set, and terminates the transfer by sending a STOP bit.

For the third segment, after the second data transfer finishes and an [I2C_END_DETECT_INT](#) is detected, the [CMD_Controller](#) registers of $I2C_{master}$ are configured as shown in Segment2. Once [I2C_TRANS_START](#) is set, $I2C_{master}$ generates a STOP bit and terminates the transfer.

Note that other $I2C_{master}$ s will not transact on the bus between two segments. The bus is only released after a STOP command is sent. The I2C controller can be reset by setting [I2C_FSM_RST](#) field at any time. This field will later be cleared automatically by hardware.

28.6.4.2 Configuration Example

1. Set [I2C_MS_MODE](#) (master) to 1, and [I2C_MS_MODE](#) (slave) to 0.
2. Write 1 to [I2C_CONF_UPGATE](#) (master) and [I2C_CONF_UPGATE](#) (slave) to synchronize registers.
3. Configure command registers of $I2C_{master}$.

Command registers	op_code	ack_value	ack_exp	ack_check_en	byte_num
I2C_COMMAND0 (master)	RSTART	—	—	—	—
I2C_COMMAND1 (master)	WRITE	ack_value	ack_exp	1	N+1
I2C_COMMAND2 (master)	END	—	—	—	—

4. Write the address of $I2C_{slave}$ and data to be sent to TX RAM of $I2C_{master}$ in either FIFO mode or non-FIFO mode according to Section [28.4.10](#).
5. Write the address of $I2C_{slave}$ to [I2C_SLAVE_ADDR](#) (slave) in [I2C_SLAVE_ADDR_REG](#) (slave) register
6. Write 1 to [I2C_CONF_UPGATE](#) (master) and [I2C_CONF_UPGATE](#) (slave) to synchronize registers.
7. Write 1 to [I2C_TRANS_START](#) (master) and [I2C_TRANS_START](#) (slave) to start transfer.
8. $I2C_{slave}$ compares the slave address sent by $I2C_{master}$ with its own address in [I2C_SLAVE_ADDR](#) (slave). When [ack_check_en](#) (master) in $I2C_{master}$'s WRITE command is 1, $I2C_{master}$ checks ACK value each time it sends a byte. When [ack_check_en](#) (master) is 0, $I2C_{master}$ does not check ACK value and take $I2C_{slave}$ as matching slave by default.
 - Match: If the received ACK value matches [ack_exp](#) (master) (the expected ACK value), $I2C_{master}$ continues data transfer.
 - Not match: If the received ACK value does not match [ack_exp](#), $I2C_{master}$ generates an [I2C_NACK_INT](#) (master) interrupt and stops data transfer.
9. $I2C_{master}$ sends data, and checks ACK value or not according to [ack_check_en](#) (master).
10. After the [I2C_END_DETECT_INT](#) (master) interrupt is generated, set [I2C_END_DETECT_INT_CLR](#) (master) to 1 to clear this interrupt.
11. Update $I2C_{master}$'s command registers.

Command registers	op_code	ack_value	ack_exp	ack_check_en	byte_num
I2C_COMMAND0 (master)	WRITE	ack_value	ack_exp	1	M
I2C_COMMAND1 (master)	END/STOP	—	—	—	—

12. Write M bytes of data to be sent to TX RAM of I2C_{master} in FIFO or non-FIFO mode.
13. Write 1 to I2C_TRANS_START (master) bit to start transfer and repeat step 9.
14. If the command is a STOP, I2C stops transfer and generates an I2C_TRANS_COMPLETE_INT (master) interrupt.
15. If the command is an END, repeat step 10.
16. Update I2C_{master}'s command registers.

Command registers of I2C _{master}	op_code	ack_value	ack_exp	ack_check_en	byte_num
I2C_COMMAND1 (master)	STOP	—	—	—	—

17. Write 1 to I2C_TRANS_START (master) bit to start transfer.
18. I2C_{master} executes the STOP command and generates an I2C_TRANS_COMPLETE_INT (master) interrupt.

28.6.5 I2C_{master} Reads I2C_{slave} with a 7-bit Address in One Command Sequence

28.6.5.1 Introduction

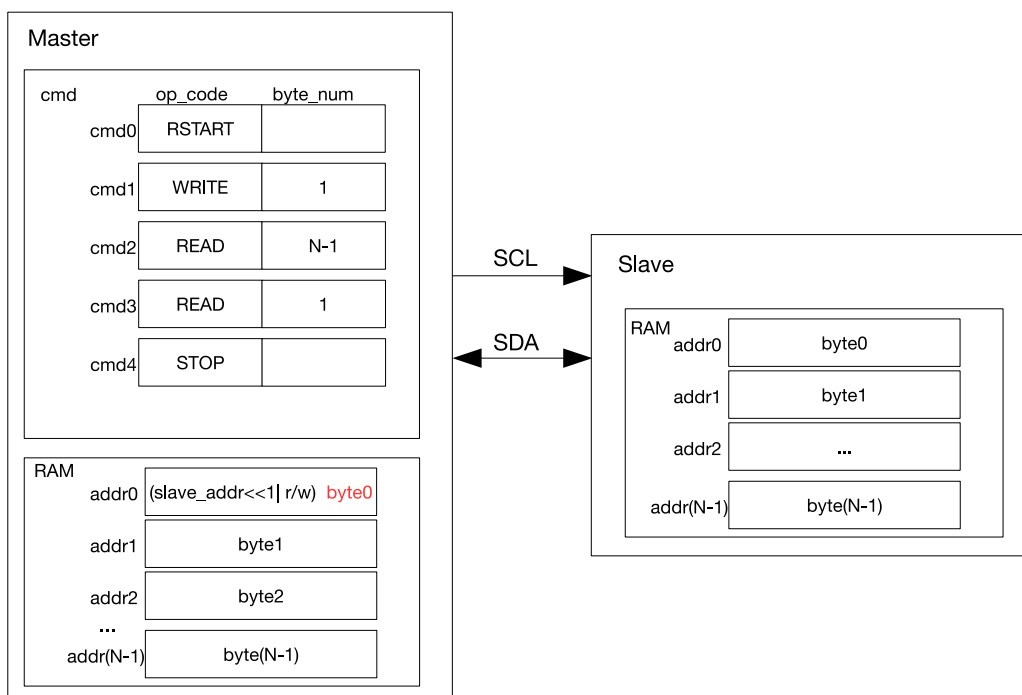

Figure 28-11. I2C_{master} Reading I2C_{slave} with a 7-bit Address

Figure 28-11 shows how I2C_{master} reads N bytes of data from an I2C slave using 7-bit addressing. cmd1 is a WRITE command, and when this command is executed I2C_{master} sends the address of I2C_{slave}. The byte sent comprises a 7-bit I2C_{slave} address and a R/\overline{W} bit. When the R/\overline{W} bit is 1, it indicates a READ operation. If the address of an I2C slave matches the sent address, this matching slave starts sending data to I2C_{master}. I2C_{master} generates acknowledgements according to ack_value defined in the READ command upon receiving a byte.

As illustrated in Figure 28-11, I2C_{master} executes two READ commands: it generates ACKs for (N-1) bytes of data in cmd2, and a NACK for the last byte of data in cmd 3. This configuration may be changed as required.

I2C_{master} writes received data into the controller RAM from addr0, whose original content (a the address of I2C_{slave} and a R/\overline{W} bit) is overwritten by byte0 marked red in Figure 28-11.

28.6.5.2 Configuration Example

1. Set I2C_MS_MODE (master) to 1, and I2C_MS_MODE (slave) to 0.
2. We recommend setting I2C_SLAVE_SCL_STRETCH_EN (slave) to 1, so that SCL can be held low for more processing time when I2C_{slave} needs to send data. If this bit is not set, software should write data to be sent to I2C_{slave}'s TX RAM before I2C_{master} initiates transfer. Configuration below is applicable to scenario where I2C_SLAVE_SCL_STRETCH_EN (slave) is 1.
3. Write 1 to I2C_CONF_UPGATE (master) and I2C_CONF_UPGATE (slave) to synchronize registers.
4. Configure command registers of I2C_{master}.

Command registers of I2C _{master}	op_code	ack_value	ack_exp	ack_check_en	byte_num
I2C_COMMAND0 (master)	RSTART	—	—	—	—
I2C_COMMAND1 (master)	WRITE	0	0	1	1
I2C_COMMAND2 (master)	READ	0	0	1	N-1
I2C_COMMAND3 (master)	READ	1	0	1	1
I2C_COMMAND4 (master)	STOP	—	—	—	—

5. Write the address of I2C_{slave} to TX RAM of I2C_{master} in either FIFO mode or non-FIFO mode according to Section 28.4.10.
6. Write the address of I2C_{slave} to I2C_SLAVE_ADDR (slave) in I2C_SLAVE_ADDR_REG (slave) register.
7. Write 1 to I2C_CONF_UPGATE (master) and I2C_CONF_UPGATE (slave) to synchronize registers.
8. Write 1 to I2C_TRANS_START (master) bit to start I2C_{master}'s transfer.
9. Start I2C_{slave}'s transfer according to Section 28.4.14.
10. I2C_{slave} compares the slave address sent by I2C_{master} with its own address in I2C_SLAVE_ADDR (slave). When ack_check_en (master) in I2C_{master}'s WRITE command is 1, I2C_{master} checks ACK value each time it sends a byte. When ack_check_en (master) is 0, I2C_{master} does not check ACK value and take I2C_{slave} as matching slave by default.
 - Match: If the received ACK value matches ack_exp (master) (the expected ACK value), I2C_{master} continues data transfer.
 - Not match: If the received ACK value does not match ack_exp, I2C_{master} generates an I2C_NACK_INT (master) interrupt and stops data transfer.
11. After I2C_SLAVE_STRETCH_INT (slave) is generated, the I2C_STRETCH_CAUSE bit is 0. The address of I2C_{slave} matches the address sent over SDA, and I2C_{slave} needs to send data.
12. Write data to be sent to TX RAM of I2C_{slave} in either FIFO mode or non-FIFO mode according to Section 28.4.10.

13. Set `I2C_SLAVE_SCL_STRETCH_CLR` (slave) to 1 to release SCL.
14. $I2C_{\text{slave}}$ sends data, and $I2C_{\text{master}}$ checks ACK value or not according to `ack_check_en` (master) in the READ command.
15. If data to be read by $I2C_{\text{master}}$ is larger than the TX FIFO depth of $I2C_{\text{slave}}$, an `I2C_SLAVE_STRETCH_INT` (slave) interrupt will be generated when TX RAM of $I2C_{\text{slave}}$ becomes empty. In this way, $I2C_{\text{slave}}$ can hold SCL low, so that software has more time to pad data in TX RAM of $I2C_{\text{slave}}$ and read data in RX RAM of $I2C_{\text{master}}$. After software has finished reading, you can set `I2C_SLAVE_STRETCH_INT_CLR` (slave) to 1 to clear interrupt, and set `I2C_SLAVE_SCL_STRETCH_CLR` (slave) to release the SCL line.
16. After $I2C_{\text{master}}$ has received the last byte of data, set `ack_value` (master) to 1. $I2C_{\text{slave}}$ will stop transfer once receiving the `I2C_NACK_INT` interrupt.
17. After data transfer completes, $I2C_{\text{master}}$ executes the STOP command, and generates an `I2C_TRANS_COMPLETE_INT` (master) interrupt.

28.6.6 $I2C_{\text{master}}$ Reads $I2C_{\text{slave}}$ with a 10-bit Address in One Command Sequence

28.6.6.1 Introduction

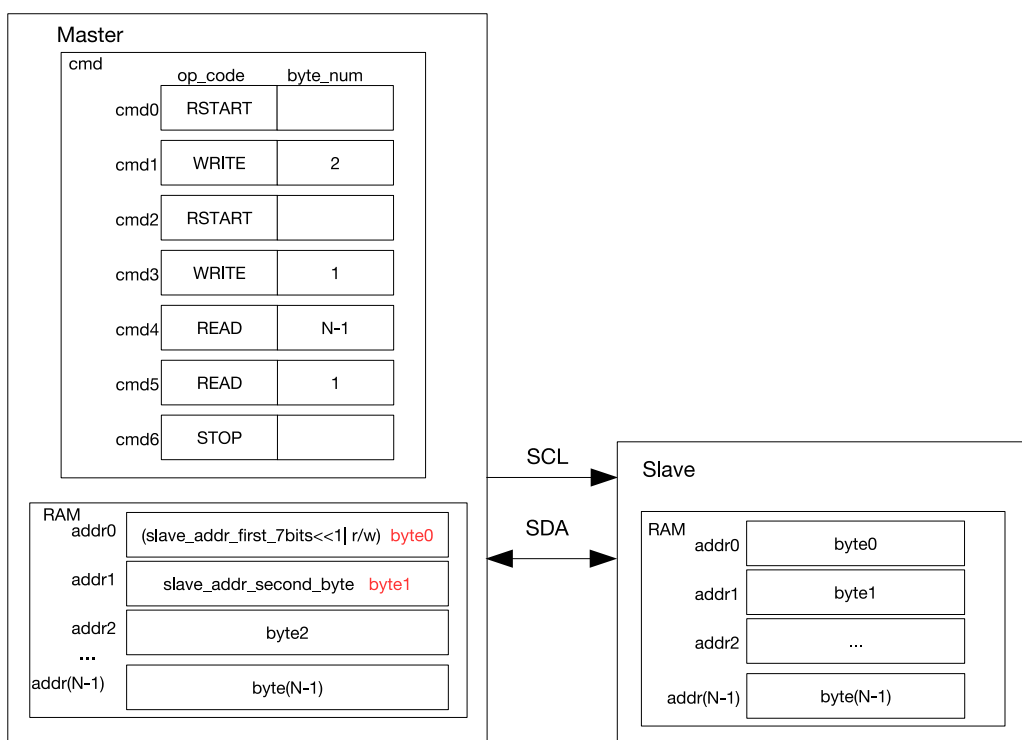

Figure 28-12. $I2C_{\text{master}}$ Reading $I2C_{\text{slave}}$ with a 10-bit Address

Figure 28-12 shows how $I2C_{\text{master}}$ reads data from an $I2C_{\text{slave}}$ using 10-bit addressing. Unlike 7-bit addressing, in 10-bit addressing the WRITE command of the $I2C_{\text{master}}$ is formed from two bytes, and correspondingly TX RAM of this master stores a 10-bit address of two bytes. The R/\overline{W} bit in the first byte is 0, which indicates a WRITE operation. After a RSTART condition, $I2C_{\text{master}}$ sends the first byte of address again to read data from $I2C_{\text{slave}}$, but the R/\overline{W} bit is 1, which indicates a READ operation. The two address bytes can be configured as described in Section 28.6.2.

28.6.6.2 Configuration Example

1. Set `I2C_MS_MODE` (master) to 1, and `I2C_MS_MODE` (slave) to 0.
2. We recommend setting `I2C_SLAVE_SCL_STRETCH_EN` (slave) to 1, so that SCL can be held low for more processing time when `I2C_slave` needs to send data. If this bit is not set, software should write data to be sent to `I2C_slave`'s TX RAM before `I2C_master` initiates transfer. Configuration below is applicable to scenario where `I2C_SLAVE_SCL_STRETCH_EN` (slave) is 1.
3. Write 1 to `I2C_CONF_UPGATE` (master) and `I2C_CONF_UPGATE` (slave) to synchronize registers.
4. Configure command registers of `I2C_master`.

Command registers of <code>I2C_master</code>	op_code	ack_value	ack_exp	ack_check_en	byte_num
<code>I2C_COMMAND0</code> (master)	RSTART	—	—	—	—
<code>I2C_COMMAND1</code> (master)	WRITE	0	0	1	2
<code>I2C_COMMAND2</code> (master)	RSTART	—	—	—	—
<code>I2C_COMMAND3</code> (master)	WRITE	0	0	1	1
<code>I2C_COMMAND4</code> (master)	READ	0	0	1	N-1
<code>I2C_COMMAND5</code> (master)	READ	1	0	1	1
<code>I2C_COMMAND6</code> (master)	STOP	—	—	—	—

5. Configure `I2C_SLAVE_ADDR` (slave) in `I2C_SLAVE_ADDR_REG` (slave) as `I2C_slave`'s 10-bit address, and set `I2C_ADDR_10BIT_EN` (slave) to 1 to enable 10-bit addressing.
6. Write the address of `I2C_slave` and data to be sent to TX RAM of `I2C_master` in either FIFO or non-FIFO mode. The first byte of address comprises $((0x78 | I2C_SLAVE_ADDR[9:8]) \ll 1)$ and a R/\overline{W} bit, which is 1 and indicates a WRITE operation. The second byte of address is `I2C_SLAVE_ADDR[7:0]`. The third byte is $((0x78 | I2C_SLAVE_ADDR[9:8]) \ll 1)$ and a R/\overline{W} bit, which is 1 and indicates a READ operation.
7. Write 1 to `I2C_CONF_UPGATE` (master) and `I2C_CONF_UPGATE` (slave) to synchronize registers.
8. Write 1 to `I2C_TRANS_START` (master) to start `I2C_master`'s transfer.
9. Start `I2C_slave`'s transfer according to Section 28.4.14.
10. `I2C_slave` compares the slave address sent by `I2C_master` with its own address in `I2C_SLAVE_ADDR` (slave). When `ack_check_en` (master) in `I2C_master`'s WRITE command is 1, `I2C_master` checks ACK value each time it sends a byte. When `ack_check_en` (master) is 0, `I2C_master` does not check ACK value and take `I2C_slave` as matching slave by default.
 - Match: If the received ACK value matches `ack_exp` (master) (the expected ACK value), `I2C_master` continues data transfer.
 - Not match: If the received ACK value does not match `ack_exp`, `I2C_master` generates an `I2C_NACK_INT` (master) interrupt and stops data transfer.
11. `I2C_master` sends a RSTART and the third byte in TX RAM, which is $((0x78 | I2C_SLAVE_ADDR[9:8]) \ll 1)$ and a R/\overline{W} bit that indicates READ.
12. `I2C_slave` repeats step 10. If its address matches the address sent by `I2C_master`, `I2C_slave` proceed on to the next steps.

13. After `I2C_SLAVE_STRETCH_INT` (slave) is generated, the `I2C_STRETCH_CAUSE` bit is 0. The address of `I2C_slave` matches the address sent over SDA, and `I2C_slave` needs to send data.
14. Write data to be sent to TX RAM of `I2C_slave` in either FIFO mode or non-FIFO mode according to Section 28.4.10.
15. Set `I2C_SLAVE_SCL_STRETCH_CLR` (slave) to 1 to release SCL.
16. `I2C_slave` sends data, and `I2C_master` checks ACK value or not according to `ack_check_en` (master) in the READ command.
17. If data to be read by `I2C_master` is larger than the TX FIFO depth of `I2C_slave`, an `I2C_SLAVE_STRETCH_INT` (slave) interrupt will be generated when TX RAM of `I2C_slave` becomes empty. In this way, `I2C_slave` can hold SCL low, so that software has more time to pad data in TX RAM of `I2C_slave` and read data in RX RAM of `I2C_master`. After software has finished reading, you can set `I2C_SLAVE_STRETCH_INT_CLR` (slave) to 1 to clear interrupt, and set `I2C_SLAVE_SCL_STRETCH_CLR` (slave) to release the SCL line.
18. After `I2C_master` has received the last byte of data, set `ack_value` (master) to 1. `I2C_slave` will stop transfer once receiving the `I2C_NACK_INT` interrupt.
19. After data transfer completes, `I2C_master` executes the STOP command, and generates an `I2C_TRANS_COMPLETE_INT` (master) interrupt.

28.6.7 I2C_{master} Reads I2C_{slave} with Two 7-bit Addresses in One Command Sequence

28.6.7.1 Introduction

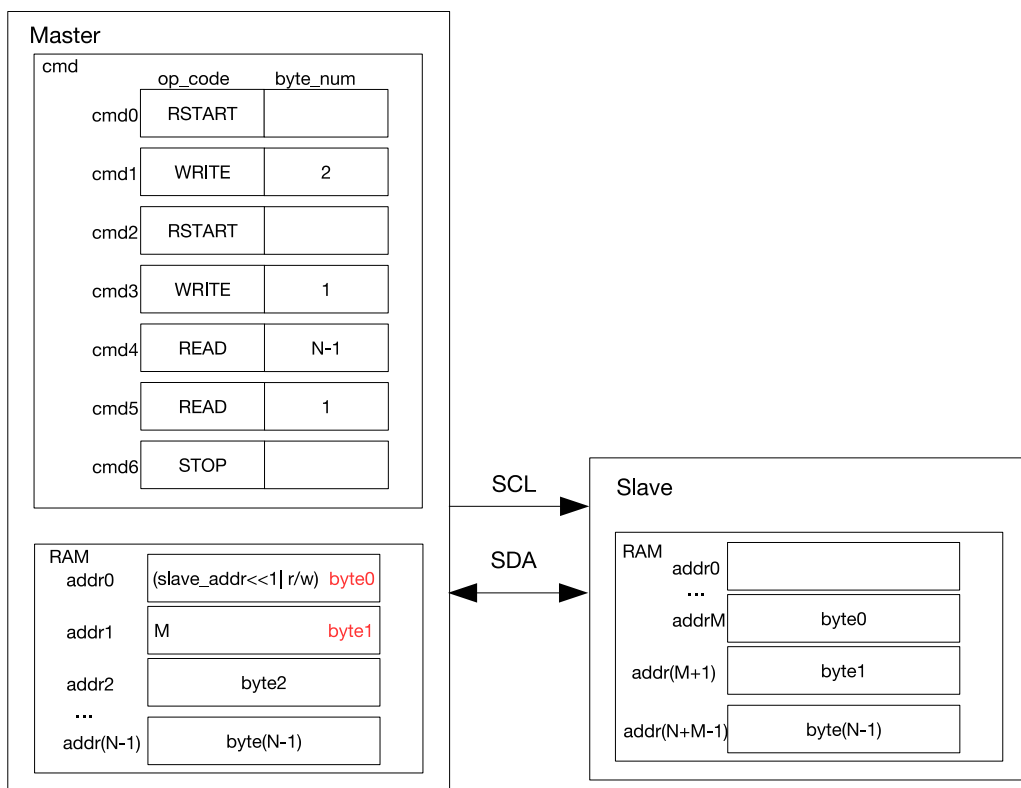

Figure 28-13. I2C_{master} Reading N Bytes of Data from addrM of I2C_{slave} with a 7-bit Address

Figure 28-13 shows how I2C_{master} reads data from specified addresses in an I2C slave. I2C_{master} sends two bytes of addresses: the first byte is a 7-bit I2C_{slave} address followed by a R/\overline{W} bit, which is 0 and indicates a WRITE; the second byte is I2C_{slave}'s memory address. After a RSTART condition, I2C_{master} sends the first byte of address again, but the R/\overline{W} bit is 1 which indicates a READ. Then, I2C_{master} reads data starting from addrM.

28.6.7.2 Configuration Example

1. Set I2C_MS_MODE (master) to 1, and I2C_MS_MODE (slave) to 0.
2. We recommend setting I2C_SLAVE_SCL_STRETCH_EN (slave) to 1, so that SCL can be held low for more processing time when I2C_{slave} needs to send data. If this bit is not set, software should write data to be sent to I2C_{slave}'s TX RAM before I2C_{master} initiates transfer. Configuration below is applicable to scenario where I2C_SLAVE_SCL_STRETCH_EN (slave) is 1.
3. Set I2C_FIFO_ADDR_CFG_EN (slave) to 1 to enable dual address mode.
4. Write 1 to I2C_CONF_UPGATE (master) and I2C_CONF_UPGATE (slave) to synchronize registers.
5. Configure command registers of I2C_{master}.

Command registers of I2C _{master}	op_code	ack_value	ack_exp	ack_check_en	byte_num
I2C_COMMAND0 (master)	RSTART	—	—	—	—
I2C_COMMAND1 (master)	WRITE	0	0	1	2
I2C_COMMAND2 (master)	RSTART	—	—	—	—
I2C_COMMAND3 (master)	WRITE	0	0	1	1
I2C_COMMAND4 (master)	READ	0	0	1	N-1
I2C_COMMAND5 (master)	READ	1	0	1	1
I2C_COMMAND6 (master)	STOP	—	—	—	—

6. Configure I2C_SLAVE_ADDR (slave) in I2C_SLAVE_ADDR_REG (slave) register as I2C_{slave}'s 7-bit address, and set I2C_ADDR_10BIT_EN (slave) to 0 to enable 7-bit addressing.
7. Write the address of I2C_{slave} and data to be sent to TX RAM of I2C_{master} in either FIFO or non-FIFO mode according to Section 28.4.10. The first byte of address comprises (I2C_SLAVE_ADDR[6:0]) \ll 1 and a R/\overline{W} bit, which is 0 and indicates a WRITE. The second byte of address is memory address M of I2C_{slave}. The third byte is (I2C_SLAVE_ADDR[6:0]) \ll 1 and a R/\overline{W} bit, which is 1 and indicates a READ.
8. Write 1 to I2C_CONF_UPGATE (master) and I2C_CONF_UPGATE (slave) to synchronize registers.
9. Write 1 to I2C_TRANS_START (master) to start I2C_{master}'s transfer.
10. Start I2C_{slave}'s transfer according to Section 28.4.14.
11. I2C_{slave} compares the slave address sent by I2C_{master} with its own address in I2C_SLAVE_ADDR (slave). When ack_check_en (master) in I2C_{master}'s WRITE command is 1, I2C_{master} checks ACK value each time it sends a byte. When ack_check_en (master) is 0, I2C_{master} does not check ACK value and take I2C_{slave} as matching slave by default.
 - Match: If the received ACK value matches ack_exp (master) (the expected ACK value), I2C_{master} continues data transfer.

- Not match: If the received ACK value does not match `ack_exp`, `I2C_master` generates an `I2C_NACK_INT` (master) interrupt and stops data transfer.
12. `I2C_slave` receives memory address sent by `I2C_master` and adds the offset.
 13. `I2C_master` sends a RSTART and the third byte in TX RAM, which is $((0x78 | I2C_SLAVE_ADDR[9:8]) \ll 1)$ and a R bit.
 14. `I2C_slave` repeats step 11. If its address matches the address sent by `I2C_master`, `I2C_slave` proceed on to the next steps.
 15. After `I2C_SLAVE_STRETCH_INT` (slave) is generated, the `I2C_STRETCH_CAUSE` bit is 0. The address of `I2C_slave` matches the address sent over SDA, and `I2C_slave` needs to send data.
 16. Write data to be sent to TX RAM of `I2C_slave` in either FIFO mode or non-FIFO mode according to Section 28.4.10.
 17. Set `I2C_SLAVE_SCL_STRETCH_CLR` (slave) to 1 to release SCL.
 18. `I2C_slave` sends data, and `I2C_master` checks ACK value or not according to `ack_check_en` (master) in the READ command.
 19. If data to be read by `I2C_master` is larger than the TX FIFO depth of `I2C_slave`, an `I2C_SLAVE_STRETCH_INT` (slave) interrupt will be generated when TX RAM of `I2C_slave` becomes empty. In this way, `I2C_slave` can hold SCL low, so that software has more time to pad data in TX RAM of `I2C_slave` and read data in RX RAM of `I2C_master`. After software has finished reading, you can set `I2C_SLAVE_STRETCH_INT_CLR` (slave) to 1 to clear interrupt, and set `I2C_SLAVE_SCL_STRETCH_CLR` (slave) to release the SCL line.
 20. After `I2C_master` has received the last byte of data, set `ack_value` (master) to 1. `I2C_slave` will stop transfer once receiving the `I2C_NACK_INT` interrupt.
 21. After data transfer completes, `I2C_master` executes the STOP command, and generates an `I2C_TRANS_COMPLETE_INT` (master) interrupt.

28.6.8 `I2C_master` Reads `I2C_slave` with a 7-bit Address in Multiple Command Sequences

28.6.8.1 Introduction

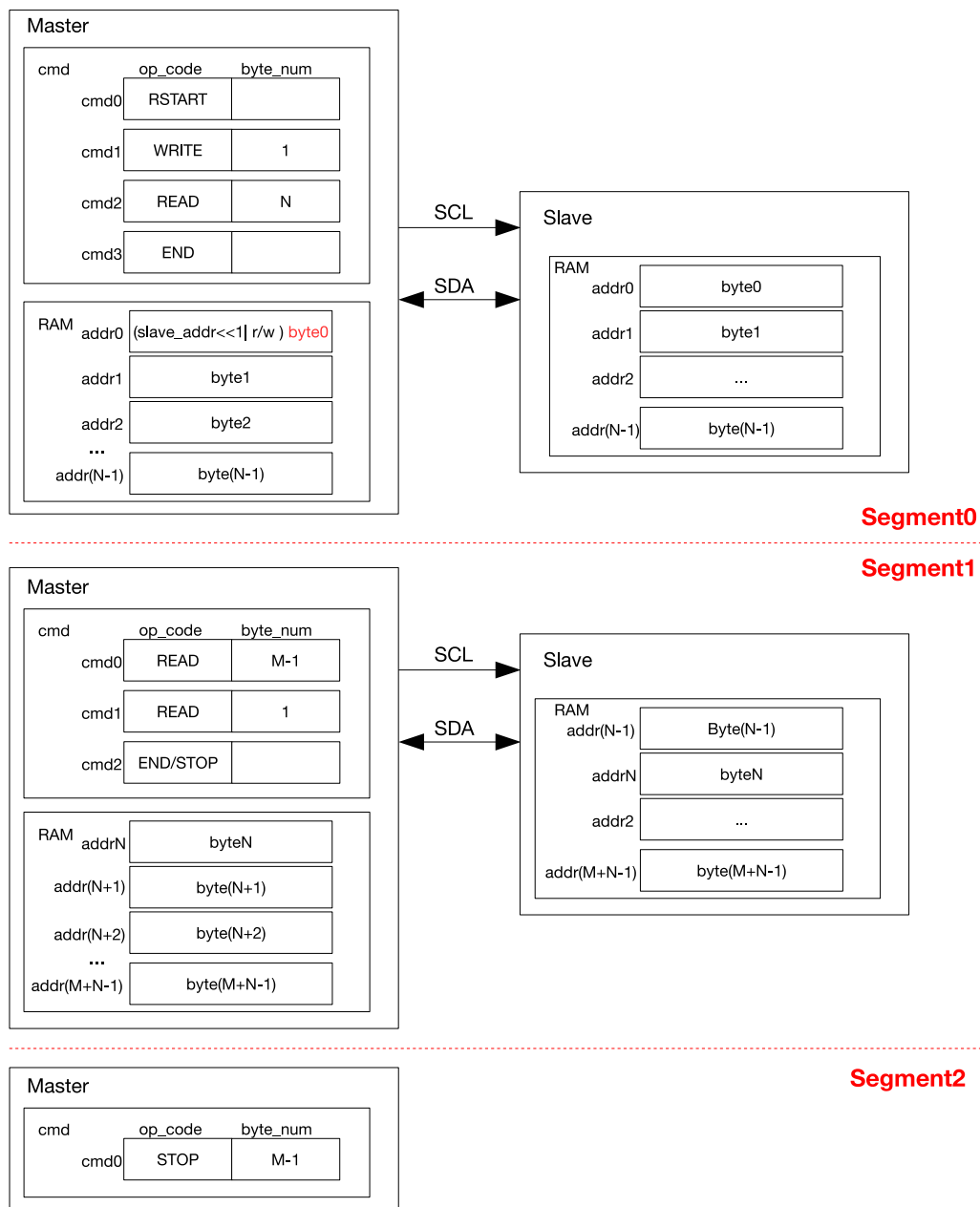

Figure 28-14. I2C_{master} Reading I2C_{slave} with a 7-bit Address in Segments

Figure 28-14 shows how I2C_{master} reads (N+M) bytes of data from an I2C slave in two/three segments separated by END commands. Configuration procedures are described as follows:

1. The procedures for Segment0 is similar to 28-11, except that the last command is an END.
2. Prepare data in the TX RAM of I2C_{slave}, and set I2C_TRANS_START to start data transfer. After executing the END command, I2C_{master} refreshes command registers and the RAM as shown in Segment1, and clears the corresponding I2C_END_DETECT_INT interrupt. If cmd2 in Segment1 is a STOP, then data is read from I2C_{slave} in two segments. I2C_{master} resumes data transfer by setting I2C_TRANS_START and terminates the transfer by sending a STOP bit.
3. If cmd2 in Segment1 is an END, then data is read from I2C_{slave} in three segments. After the second data

transfer finishes and an I2C_END_DETECT_INT interrupt is detected, the cmd box is configured as shown in Segment2. Once I2C_TRANS_START is set, I2C_{master} terminates the transfer by sending a STOP bit.

28.6.8.2 Configuration Example

1. Set I2C_MS_MODE (master) to 1, and I2C_MS_MODE (slave) to 0.
2. We recommend setting I2C_SLAVE_SCL_STRETCH_EN (slave) to 1, so that SCL can be held low for more processing time when I2C_{slave} needs to send data. If this bit is not set, software should write data to be sent to I2C_{slave}'s TX RAM before I2C_{master} initiates transfer. Configuration below is applicable to scenario where I2C_SLAVE_SCL_STRETCH_EN (slave) is 1.
3. Write 1 to I2C_CONF_UPGATE (master) and I2C_CONF_UPGATE (slave) to synchronize registers.
4. Configure command registers of I2C_{master}.

Command registers of I2C _{master}	op_code	ack_value	ack_exp	ack_check_en	byte_num
I2C_COMMAND0 (master)	RSTART	—	—	—	—
I2C_COMMAND1 (master)	WRITE	0	0	1	1
I2C_COMMAND2 (master)	READ	0	0	1	N
I2C_COMMAND3 (master)	END	—	—	—	—

5. Write the address of I2C_{slave} to TX RAM of I2C_{master} in FIFO or non-FIFO mode.
6. Write the address of I2C_{slave} to I2C_SLAVE_ADDR (slave) in I2C_SLAVE_ADDR_REG (slave) register.
7. Write 1 to I2C_CONF_UPGATE (master) and I2C_CONF_UPGATE (slave) to synchronize registers.
8. Write 1 to I2C_TRANS_START (master) to start I2C_{master}'s transfer.
9. Start I2C_{slave}'s transfer according to Section 28.4.14.
10. I2C_{slave} compares the slave address sent by I2C_{master} with its own address in I2C_SLAVE_ADDR (slave). When ack_check_en (master) in I2C_{master}'s WRITE command is 1, I2C_{master} checks ACK value each time it sends a byte. When ack_check_en (master) is 0, I2C_{master} does not check ACK value and take I2C_{slave} as matching slave by default.
 - Match: If the received ACK value matches ack_exp (master) (the expected ACK value), I2C_{master} continues data transfer.
 - Not match: If the received ACK value does not match ack_exp, I2C_{master} generates an I2C_NACK_INT (master) interrupt and stops data transfer.
11. After I2C_SLAVE_STRETCH_INT (slave) is generated, the I2C_STRETCH_CAUSE bit is 0. The address of I2C_{slave} matches the address sent over SDA, and I2C_{slave} needs to send data.
12. Write data to be sent to TX RAM of I2C_{slave} in either FIFO mode or non-FIFO mode according to Section 28.4.10.
13. Set I2C_SLAVE_SCL_STRETCH_CLR (slave) to 1 to release SCL.
14. I2C_{slave} sends data, and I2C_{master} checks ACK value or not according to ack_check_en (master) in the READ command.

15. If data to be read by I2C_{master} in one READ command (N or M) is larger than the TX FIFO depth of I2C_{slave}, an I2C_SLAVE_STRETCH_INT (slave) interrupt will be generated when TX RAM of I2C_{slave} becomes empty. In this way, I2C_{slave} can hold SCL low, so that software has more time to pad data in TX RAM of I2C_{slave} and read data in RX RAM of I2C_{master}. After software has finished reading, you can set I2C_SLAVE_STRETCH_INT_CLR (slave) to 1 to clear interrupt, and set I2C_SLAVE_SCL_STRETCH_CLR (slave) to release the SCL line.
16. Once finishing reading data in the first READ command, I2C_{master} executes the END command and triggers an I2C_END_DETECT_INT (master) interrupt, which is cleared by setting I2C_END_DETECT_INT_CLR (master) to 1.
17. Update I2C_{master}'s command registers using one of the following two methods:

Command registers of I2C _{master}	op_code	ack_value	ack_exp	ack_check_en	byte_num
I2C_COMMAND0 (master)	READ	ack_value	ack_exp	1	M
I2C_COMMAND1 (master)	END	—	—	—	—

Or

Command registers of I2C _{master}	op_code	ack_value	ack_exp	ack_check_en	byte_num
I2C_COMMAND0 (master)	READ	0	0	1	M-1
I2C_COMMAND0 (master)	READ	1	0	1	1
I2C_COMMAND1 (master)	STOP	—	—	—	—

18. Write M bytes of data to be sent to TX RAM of I2C_{slave}. If M is larger than the TX FIFO depth, then repeat step 12 in FIFO or non-FIFO mode.
19. Write 1 to I2C_TRANS_START (master) bit to start transfer and repeat step 14.
20. If the last command is a STOP, then set ack_value (master) to 1 after I2C_{master} has received the last byte of data. I2C_{slave} stops transfer upon the I2C_NACK_INT interrupt. I2C_{master} executes the STOP command to stop transfer and generates an I2C_TRANS_COMPLETE_INT (master) interrupt.
21. If the last command is an END, then repeat step 16 and proceed on to the next steps.
22. Update I2C_{master}'s command registers.

Command registers of I2C _{master}	op_code	ack_value	ack_exp	ack_check_en	byte_num
I2C_COMMAND1 (master)	STOP	—	—	—	—

23. Write 1 to I2C_TRANS_START (master) bit to start transfer.
24. I2C_{master} executes the STOP command to stop transfer, and generates an I2C_TRANS_COMPLETE_INT (master) interrupt.

28.7 Interrupts

- I2C_SLAVE_STRETCH_INT: Generated when one of the four stretching events occurs in slave mode.

- I2C_DET_START_INT: Triggered when the master or the slave detects a START signal.
- I2C_SCL_MAIN_ST_TO_INT: Triggered when the main state machine SCL_MAIN_FSM remains unchanged for over [I2C_SCL_MAIN_ST_TO_I2C\[23:0\]](#) clock cycles.
- I2C_SCL_ST_TO_INT: Triggered when the state machine SCL_FSM remains unchanged for over [I2C_SCL_ST_TO_I2C\[23:0\]](#) clock cycles.
- I2C_RXFIFO_UDF_INT: Triggered when the I2C controller reads RX FIFO via the APB bus, but RX FIFO is empty.
- I2C_TXFIFO_OVF_INT: Triggered when the I2C controller writes TX FIFO via the APB bus, but TX FIFO is full.
- I2C_NACK_INT: Triggered when the ACK value received by the master is not as expected, or when the ACK value received by the slave is 1.
- I2C_TRANS_START_INT: Triggered when the I2C controller sends a START bit.
- I2C_TIME_OUT_INT: Triggered when SCL stays high or low for more than [I2C_TIME_OUT_VALUE](#) clock cycles during data transfer.
- I2C_TRANS_COMPLETE_INT: Triggered when the I2C controller detects a STOP bit.
- I2C_MST_TXFIFO_UDF_INT: Triggered when TX FIFO of the master underflows.
- I2C_ARBITRATION_LOST_INT: Triggered when the SDA's output value does not match its input value while the master's SCL is high.
- I2C_BYTE_TRANS_DONE_INT: Triggered when the I2C controller sends or receives a byte.
- I2C_END_DETECT_INT: Triggered when op_code of the master indicates an END command and an END condition is detected.
- I2C_RXFIFO_OVF_INT: Triggered when RX FIFO of the I2C controller overflows.
- I2C_TXFIFO_WM_INT: I2C TX FIFO watermark interrupt. Triggered when [I2C_FIFO_PRT_EN](#) is 1 and the pointers of TX FIFO are less than [I2C_TXFIFO_WM_THRHD\[4:0\]](#).
- I2C_RXFIFO_WM_INT: I2C RX FIFO watermark interrupt. Triggered when [I2C_FIFO_PRT_EN](#) is 1 and the pointers of RX FIFO are greater than [I2C_RXFIFO_WM_THRHD\[4:0\]](#).
- I2C_SLAVE_ADDR_UNMATCH_INT: Triggered when the received slave address is inconsistent with the internally configured slave address in slave mode.

28.8 Register Summary

28.9 I2C Register Summary

The addresses in this section are relative to **I2C Controller** base address provided in Table 5-2 in Chapter 5 *System and Memory*.

The abbreviations given in Column **Access** are explained in Section *Access Types for Registers*.

Name	Description	Address	Access
Timing registers			
I2C_SCL_LOW_PERIOD_REG	Configures the low level width of the SCL Clock	0x0000	R/W
I2C_SDA_HOLD_REG	Configures the hold time after a negative SCL edge	0x0030	R/W
I2C_SDA_SAMPLE_REG	Configures the sample time after a positive SCL edge	0x0034	R/W
I2C_SCL_HIGH_PERIOD_REG	Configures the high level width of SCL	0x0038	R/W
I2C_SCL_START_HOLD_REG	Configures the delay between the SDA and SCL negative edge for a start condition	0x0040	R/W
I2C_SCL_RSTART_SETUP_REG	Configures the delay between the positive edge of SCL and the negative edge of SDA	0x0044	R/W
I2C_SCL_STOP_HOLD_REG	Configures the delay after the SCL clock edge for a stop condition	0x0048	R/W
I2C_SCL_STOP_SETUP_REG	Configures the delay between the SDA and SCL rising edge for a stop condition Measurement unit: i2c_sclk	0x004C	R/W
I2C_SCL_ST_TIME_OUT_REG	SCL status time out register	0x0078	R/W
I2C_SCL_MAIN_ST_TIME_OUT_REG	SCL main status time out register	0x007C	R/W
Configuration registers			
I2C_CTR_REG	Transmission setting	0x0004	varies
I2C_TO_REG	Setting time out control for receiving data	0x000C	R/W
I2C_SLAVE_ADDR_REG	Local slave address setting	0x0010	R/W
I2C_FIFO_CONF_REG	FIFO configuration register	0x0018	R/W
I2C_FILTER_CFG_REG	SCL and SDA filter configuration register	0x0050	R/W
I2C_SCL_SP_CONF_REG	Power configuration register	0x0080	varies
I2C_SCL_STRETCH_CONF_REG	Set SCL stretch of I2C slave	0x0084	varies
Status registers			
I2C_SR_REG	Describe I2C work status	0x0008	RO
I2C_FIFO_ST_REG	FIFO status register	0x0014	RO
I2C_DATA_REG	Rx FIFO read data	0x001C	HRO
Interrupt registers			
I2C_INT_RAW_REG	Raw interrupt status	0x0020	R/SS/WTC
I2C_INT_CLR_REG	Interrupt clear bits	0x0024	WT
I2C_INT_ENA_REG	Interrupt enable bits	0x0028	R/W
I2C_INT_STATUS_REG	Status of captured I2C communication events	0x002C	RO
Command registers			

Name	Description	Address	Access
I2C_COMD0_REG	I2C command register 0	0x0058	varies
I2C_COMD1_REG	I2C command register 1	0x005C	varies
I2C_COMD2_REG	I2C command register 2	0x0060	varies
I2C_COMD3_REG	I2C command register 3	0x0064	varies
I2C_COMD4_REG	I2C command register 4	0x0068	varies
I2C_COMD5_REG	I2C command register 5	0x006C	varies
I2C_COMD6_REG	I2C command register 6	0x0070	varies
I2C_COMD7_REG	I2C command register 7	0x0074	varies
Version register			
I2C_DATE_REG	Version register	0x00F8	R/W
Address register			
I2C_TXFIFO_START_ADDR_REG	I2C TXFIFO base address register	0x0100	HRO
I2C_RXFIFO_START_ADDR_REG	I2C RXFIFO base address register	0x0180	HRO

28.10 LP_I2C Register Summary

The abbreviations given in Column **Access** are explained in Section [Access Types for Registers](#).

Name	Description	Address	Access
Timing registers			
LP_I2C_SCL_LOW_PERIOD_REG	Configures the low level width of the SCL Clock	0x0000	R/W
LP_I2C_SDA_HOLD_REG	Configures the hold time after a negative SCL edge	0x0030	R/W
LP_I2C_SDA_SAMPLE_REG	Configures the sample time after a positive SCL edge	0x0034	R/W
LP_I2C_SCL_HIGH_PERIOD_REG	Configures the high level width of SCL	0x0038	R/W
LP_I2C_SCL_START_HOLD_REG	Configures the delay between the SDA and SCL negative edge for a start condition	0x0040	R/W
LP_I2C_SCL_RSTART_SETUP_REG	Configures the delay between the positive edge of SCL and the negative edge of SDA	0x0044	R/W
LP_I2C_SCL_STOP_HOLD_REG	Configures the delay after the SCL clock edge for a stop condition	0x0048	R/W
LP_I2C_SCL_STOP_SETUP_REG	Configures the delay between the SDA and SCL positive edge for a stop condition	0x004C	R/W
LP_I2C_SCL_ST_TIME_OUT_REG	SCL status time out register	0x0078	R/W
LP_I2C_SCL_MAIN_ST_TIME_OUT_REG	SCL main status time out register	0x007C	R/W
Configuration registers			
LP_I2C_CTR_REG	Transmission setting	0x0004	varies
LP_I2C_TO_REG	Setting time out control for receiving data	0x000C	R/W
LP_I2C_FIFO_CONF_REG	FIFO configuration register	0x0018	R/W
LP_I2C_FILTER_CFG_REG	SCL and SDA filter configuration register	0x0050	R/W
LP_I2C_SCL_SP_CONF_REG	Power configuration register	0x0080	varies
Status registers			
LP_I2C_SR_REG	Describe I2C work status	0x0008	RO

Name	Description	Address	Access
LP_I2C_FIFO_ST_REG	FIFO status register	0x0014	RO
LP_I2C_DATA_REG	Rx FIFO read data	0x001C	RO
Interrupt registers			
LP_I2C_INT_RAW_REG	Raw interrupt status	0x0020	R/SS/MTC
LP_I2C_INT_CLR_REG	Interrupt clear bits	0x0024	WT
LP_I2C_INT_ENA_REG	Interrupt enable bits	0x0028	R/W
LP_I2C_INT_STATUS_REG	Status of captured I2C communication events	0x002C	RO
Command registers			
LP_I2C_COMD0_REG	I2C command register 0	0x0058	varies
LP_I2C_COMD1_REG	I2C command register 1	0x005C	varies
LP_I2C_COMD2_REG	I2C command register 2	0x0060	varies
LP_I2C_COMD3_REG	I2C command register 3	0x0064	varies
LP_I2C_COMD4_REG	I2C command register 4	0x0068	varies
LP_I2C_COMD5_REG	I2C command register 5	0x006C	varies
LP_I2C_COMD6_REG	I2C command register 6	0x0070	varies
LP_I2C_COMD7_REG	I2C command register 7	0x0074	varies
Version register			
LP_I2C_DATE_REG	Version register	0x00F8	R/W
Address register			
LP_I2C_TXFIFO_START_ADDR_REG	I2C TXFIFO base address register	0x0100	HRO
LP_I2C_RXFIFO_START_ADDR_REG	I2C RXFIFO base address register	0x0180	HRO

28.11 I2C Registers

The addresses in this section are relative to **I2C Controller** base address provided in Table 5-2 in Chapter 5 *System and Memory*.

Register 28.1. I2C_SCL_LOW_PERIOD_REG (0x0000)

31	(reserved)	9	8	0	I2C_SCL_LOW_PERIOD	
0 0				0		Reset

I2C_SCL_LOW_PERIOD Configures the low level width of the SCL Clock in master mode.

Measurement unit: i2c_sclk

(R/W)

Register 28.2. I2C_SDA_HOLD_REG (0x0030)

31	(reserved)	9	8	0	I2C_SDA_HOLD_TIME	
0 0				0		Reset

I2C_SDA_HOLD_TIME Configures the time to hold the data after the falling edge of SCL.

Measurement unit: i2c_sclk

(R/W)

Register 28.3. I2C_SDA_SAMPLE_REG (0x0034)

31	(reserved)	9	8	0	I2C_SDA_SAMPLE_TIME	
0 0				0		Reset

I2C_SDA_SAMPLE_TIME Configures the time for sampling SDA.

Measurement unit: i2c_sclk

(R/W)

Register 28.4. I2C_SCL_HIGH_PERIOD_REG (0x0038)

<i>(reserved)</i>																<i>I2C_SCL_WAIT_HIGH_PERIOD</i>				<i>I2C_SCL_HIGH_PERIOD</i>				
31															16	15			9	8			0	
0																0				0				Reset

I2C_SCL_HIGH_PERIOD Configures for how long SCL remains high in master mode.

Measurement unit: i2c_sclk

(R/W)

I2C_SCL_WAIT_HIGH_PERIOD Configures the SCL_FSM's waiting period for SCL high level in master mode.

Measurement unit: i2c_sclk

(R/W)

Register 28.5. I2C_SCL_START_HOLD_REG (0x0040)

<i>(reserved)</i>																<i>I2C_SCL_START_HOLD_TIME</i>				
31															9	8			0	
0																8				Reset

I2C_SCL_START_HOLD_TIME Configures the time between the falling edge of SDA and the falling edge of SCL for a START condition.

Measurement unit: i2c_sclk

(R/W)

Register 28.6. I2C_SCL_RSTART_SETUP_REG (0x0044)

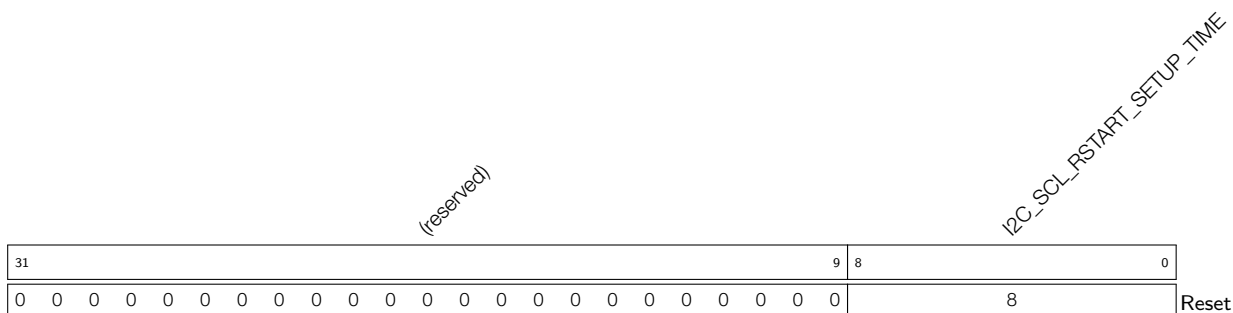

I2C_SCL_RSTART_SETUP_TIME Configures the time between the positive edge of SCL and the negative edge of SDA for a RESTART condition.

Measurement unit: i2c_sclk

(R/W)

Register 28.7. I2C_SCL_STOP_HOLD_REG (0x0048)

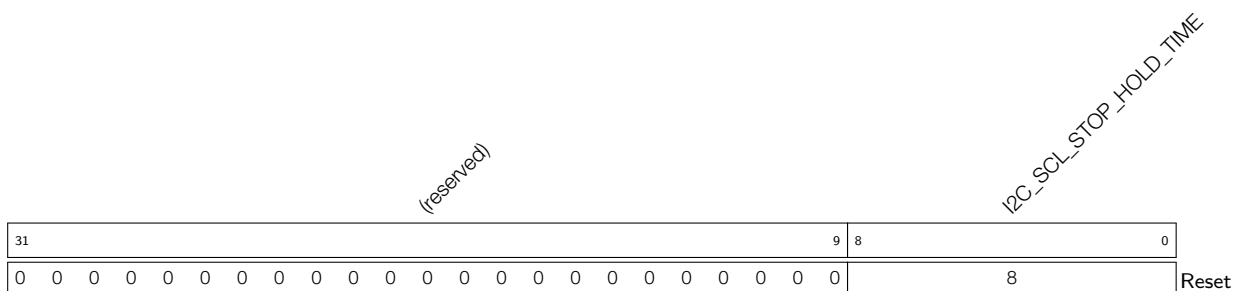

I2C_SCL_STOP_HOLD_TIME Configures the delay after the STOP condition.

Measurement unit: i2c_sclk

(R/W)

Register 28.8. I2C_SCL_STOP_SETUP_REG (0x004C)

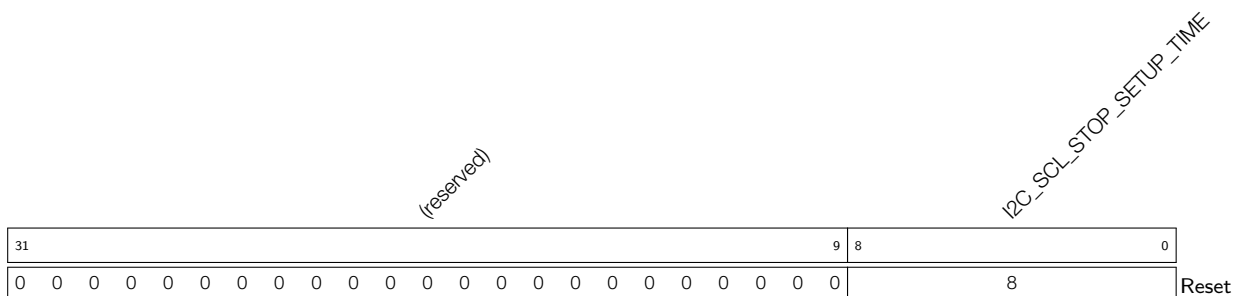

I2C_SCL_STOP_SETUP_TIME Configures the time between the rising edge of SCL and the rising edge of SDA.

Measurement unit: i2c_sclk

(R/W)

Register 28.9. I2C_SCL_ST_TIME_OUT_REG (0x0078)

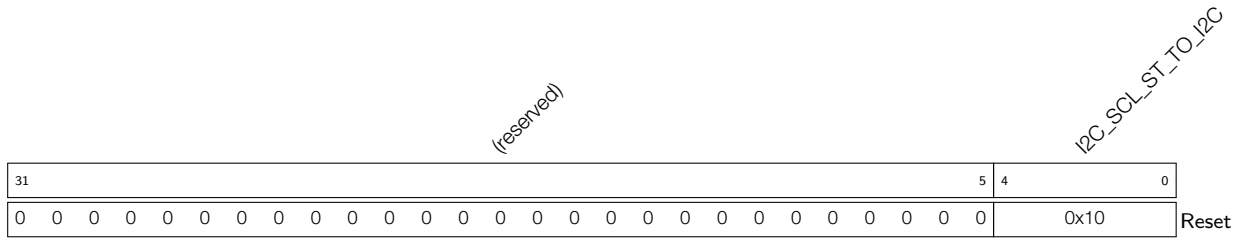

I2C_SCL_ST_TO_I2C Configures the threshold value of SCL_FSM state unchanged period. It should be no more than 23.

Measurement unit: i2c_sclk

(R/W)

Register 28.10. I2C_SCL_MAIN_ST_TIME_OUT_REG (0x007C)

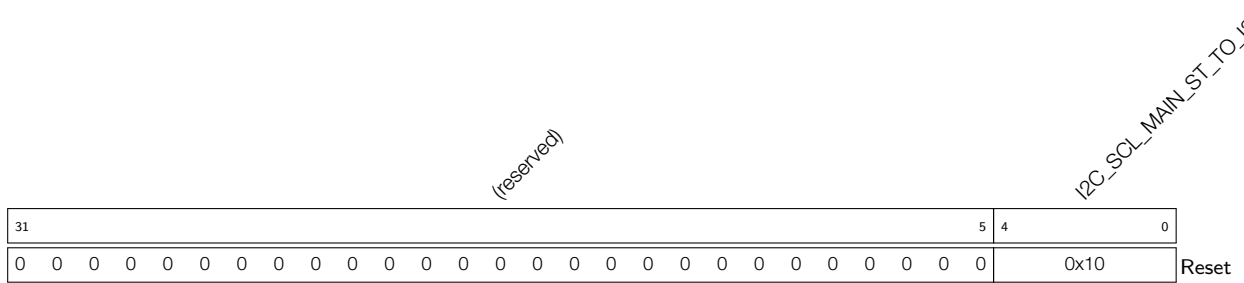

I2C_SCL_MAIN_ST_TO_I2C Configures the threshold value of SCL_MAIN_FSM state unchanged period. It should be no more than 23.

Measurement unit: i2c_sclk

(R/W)

Register 28.11. I2C_CTR_REG (0x0004)

Continued from the previous page...

I2C_CLK_EN Configures whether to gate clock signal for registers.

0: Support clock only when registers are read or written to by software

1: Force clock on for registers

(R/W)

I2C_ARBITRATION_EN Configures to enable I2C bus arbitration detection.

0: No effect

1: Enable

(R/W)

I2C_FSM_RST Configures to reset the SCL_FSM.

0: No effect

1: Reset (WT)

I2C_CONF_UPGATE Configures this bit for synchronization.

0: No effect

1: Synchronize (WT)

I2C_SLV_TX_AUTO_START_EN Configures to enable slave to send data automatically

0: Disable

1: Enable

(R/W)

I2C_ADDR_10BIT_RW_CHECK_EN Configures to check if the r/w bit of 10bit addressing consists with I2C protocol.

0: Not check

1: Check (R/W)

I2C_ADDR_BROADCASTING_EN Configures to support the 7 bit general call function.

0: Not support

1: Support

(R/W)

Register 28.12. I2C_TO_REG (0x000C)

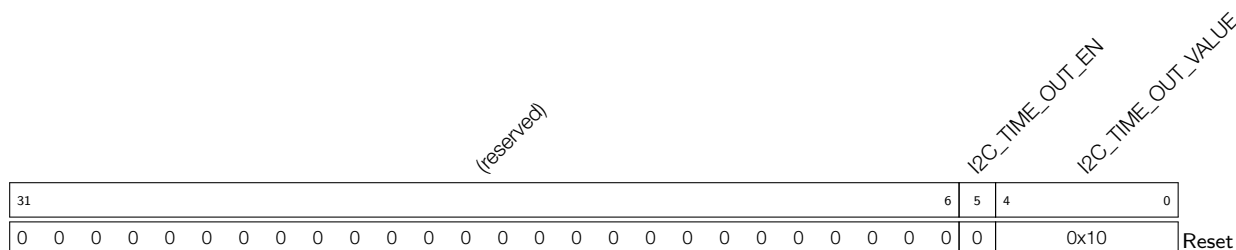

I2C_TIME_OUT_VALUE Configures the timeout threshold period for SCL stucking at high or low level.
 The actual period is $2^{(reg_time_out_value)}$.
 Measurement unit: `i2c_sclk`
 (R/W)

I2C_TIME_OUT_EN Configures to enable time out control.
 0: No effect
 1: Enable
 (R/W)

Register 28.13. I2C_SLAVE_ADDR_REG (0x0010)

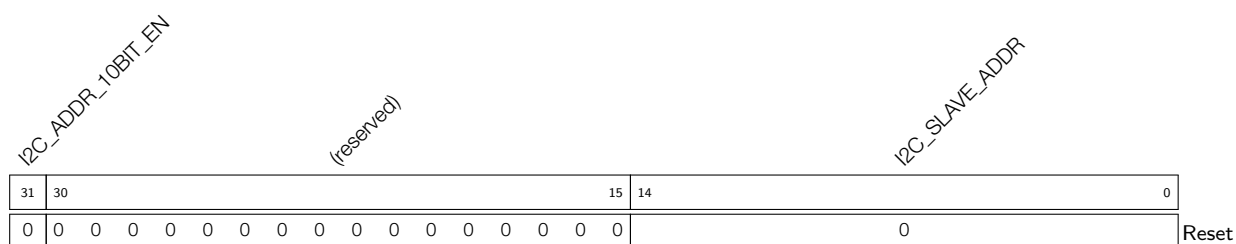

I2C_SLAVE_ADDR Configure the slave address of I2C Slave.
 (R/W)

I2C_ADDR_10BIT_EN Configures to enable the slave 10-bit addressing mode in master mode.
 0: No effect
 1: Enable
 (R/W)

Register 28.14. I2C_FIFO_CONF_REG (0x0018)

(reserved)														I2C_FIFO_PRT_EN				I2C_TX_FIFO_RST				I2C_RX_FIFO_RST				I2C_FIFO_ADDR_CFG_EN				I2C_NONFIFO_EN				I2C_TXFIFO_WM_THRHD				I2C_RXFIFO_WM_THRHD			
31															15	14	13	12	11	10	9					5	4					0									
0 0 0 0 0 0 0 0 0 0 0 0 0 0 0 0														1	0	0	0	0	0	0x4				0xb				Reset													

I2C_RXFIFO_WM_THRHD Configures the water mark threshold of RXFIFO in nonfifo access mode. When I2C_FIFO_PRT_EN is 1 and RX FIFO counter is bigger than I2C_RXFIFO_WM_THRHD[4:0], I2C_RXFIFO_WM_INT_RAW bit will be valid. (R/W)

I2C_TXFIFO_WM_THRHD Configures the water mark threshold of TXFIFO in nonfifo access mode. When I2C_FIFO_PRT_EN is 1 and TC FIFO counter is bigger than I2C_TXFIFO_WM_THRHD[4:0], I2C_TXFIFO_WM_INT_RAW bit will be valid. (R/W)

I2C_NONFIFO_EN Configures to enable APB nonfifo access. (R/W)

I2C_FIFO_ADDR_CFG_EN Configures the slave to enable dual address mode. When this mode is enabled, the byte received after the I2C address byte represents the offset address in the I2C Slave RAM.
 0: Disable
 1: Enable
 (R/W)

I2C_RX_FIFO_RST Configures to reset RXFIFO.
 0: No effect
 1: Reset (R/W)

I2C_TX_FIFO_RST Configures to reset TXFIFO.
 0: No effect
 1: Reset (R/W)

I2C_FIFO_PRT_EN Configures to enable FIFO pointer in non-fifo access mode. This bit controls the valid bits and the TX/RX FIFO overflow, underflow, full and empty interrupts.
 0: No effect
 1: Enable
 (R/W)

Register 28.15. I2C_FILTER_CFG_REG (0x0050)

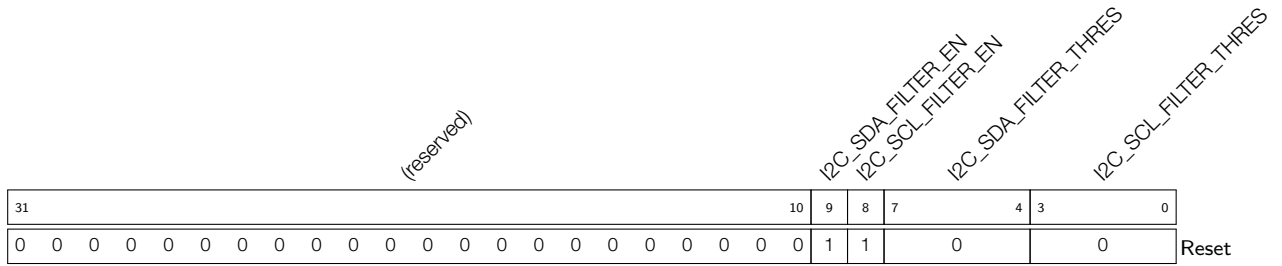

I2C_SCL_FILTER_THRES Configures the threshold pulse width to be filtered on SCL. When a pulse on the SCL input has smaller width than this register value, the I2C controller will ignore that pulse.
 Measurement unit: i2c_sclk
 (R/W)

I2C_SDA_FILTER_THRES Configures the threshold pulse width to be filtered on SDA. When a pulse on the SDA input has smaller width than this register value, the I2C controller will ignore that pulse.
 Measurement unit: i2c_sclk
 (R/W)

I2C_SCL_FILTER_EN Configures to enable the filter function for SCL.
 0: No effect
 1: Enable
 (R/W)

I2C_SDA_FILTER_EN Configures to enable the filter function for SDA.
 0: No effect
 1: Enable
 (R/W)

Register 28.16. I2C_SCL_SP_CONF_REG (0x0080)

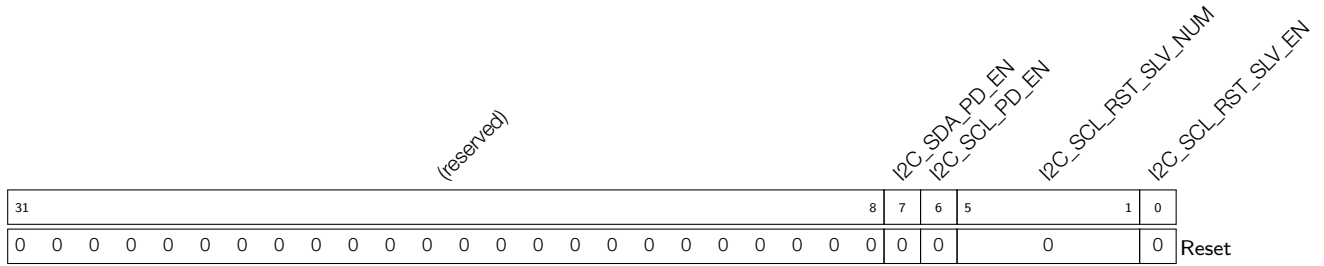

I2C_SCL_RST_SLV_EN Configures to send out SCL pulses when I2C master is IDLE. The number of pulses equals to I2C_SCL_RST_SLV_NUM[4:0]. (R/W/SC)

I2C_SCL_RST_SLV_NUM Configure the pulses of SCL generated in I2C master mode.
 Valid when I2C_SCL_RST_SLV_EN is 1.
 Measurement unit: i2c_sclk
 (R/W)

I2C_SCL_PD_EN Configures to power down the I2C output SCL line.
 0: Not power down.
 1: Not work and power down.
 Valid only when I2C_SCL_FORCE_OUT is 1. (R/W)

I2C_SDA_PD_EN Configures to power down the I2C output SDA line.
 0: Not power down.
 1: Not work and power down.
 Valid only when I2C_SDA_FORCE_OUT is 1. (R/W)

Register 28.17. I2C_SCL_STRETCH_CONF_REG (0x0084)

(reserved)														I2C_SLAVE_BYTE_ACK_LVL				I2C_SLAVE_BYTE_ACK_CTL_EN				I2C_SLAVE_SCL_STRETCH_CLR				I2C_SLAVE_SCL_STRETCH_EN				I2C_STRETCH_PROTECT_NUM			
31															14	13	12	11	10	9					0								
0 0 0 0 0 0 0 0 0 0 0 0 0 0 0														0	0	0	0	0	0	0				Reset									

I2C_STRETCH_PROTECT_NUM Configures the time period to release the SCL line from stretching to avoid timing violation. Usually it should be larger than the SDA setup time.

Measurement unit: i2c_sclk

(R/W)

I2C_SLAVE_SCL_STRETCH_EN Configures to enable slave SCL stretch function. The SCL output line will be stretched low when I2C_SLAVE_SCL_STRETCH_EN is 1 and stretch event happens. The stretch cause can be seen in I2C_STRETCH_CAUSE.

0: Disable

1: Enable

(R/W)

I2C_SLAVE_SCL_STRETCH_CLR Configures to clear the I2C slave SCL stretch function.

0: No effect

1: Clear

(WT)

I2C_SLAVE_BYTE_ACK_CTL_EN Configures to enable the function for slave to control ACK level.

0: Disable

1: Enable

(R/W)

I2C_SLAVE_BYTE_ACK_LVL Set the ACK level when slave controlling ACK level function enables.

0: Low level

1: High level

(R/W)

Register 28.18. I2C_SR_REG (0x0008)

(reserved)		I2C_SCL_STATE_LAST		(reserved)		I2C_SCL_MAIN_STATE_LAST		I2C_TXFIFO_CNT		(reserved)		I2C_STRETCH_CAUSE		I2C_RXFIFO_CNT		(reserved)		I2C_SLAVE_ADDRESSED		I2C_BUS_BUSY		I2C_ARB_LOST		(reserved)		I2C_SLAVE_RW		I2C_RESP_REC	
31	30	28	27	26	24	23	18	17	16	15	14	13	8	7	6	5	4	3	2	1	0	Reset							
0	0	0	0	0	0	0	0	0	0	0x3	0	0	0	0	0	0	0	0	0	0	0	0	0	0	0	0	0	0	0

I2C_RESP_REC Represents the received ACK value in master mode or slave mode.

- 0: ACK
- 1: NACK. (RO)

I2C_SLAVE_RW Represents the transfer direction in slave mode.

- 1: Master reads from slave
- 0: Master writes to slave. (RO)

I2C_ARB_LOST Represents whether the I2C controller loses control of SCL line.

- 0: No arbitration lost
 - 1: Arbitration lost
- (RO)

I2C_BUS_BUSY Represents the I2C bus state.

- 1: The I2C bus is busy transferring data
 - 0: The I2C bus is in idle state.
- (RO)

I2C_SLAVE_ADDRESSED Represents whether the address sent by the master is equal to the address of the slave.

- Valid only when the module is configured as an I2C Slave.
- 0: Not equal
 - 1: Equal
- (RO)

I2C_RXFIFO_CNT Represents the number of data bytes received in RAM. (RO)

I2C_STRETCH_CAUSE Represents the cause of SCL clocking stretching in slave mode.

- 0: Stretching SCL low when the master starts to read data.
- 1: Stretching SCL low when I2C TX FIFO is empty in slave mode.
- 2: Stretching SCL low when I2C RX FIFO is full in slave mode. (RO)

I2C_TXFIFO_CNT Represents the number of data bytes to be sent. (RO)

Continued on the next page...

Register 28.18. I2C_SR_REG (0x0008)

Continued from the previous page...

I2C_SCL_MAIN_STATE_LAST Represents the states of the I2C module state machine.

- 0: Idle
- 1: Address shift
- 2: ACK address
- 3: Rx data
- 4: Tx data
- 5: Send ACK
- 6: Wait ACK (RO)

I2C_SCL_STATE_LAST Represents the states of the state machine used to produce SCL.

- 0: Idle
- 1: Start
- 2: Negative edge
- 3: Low
- 4: Positive edge
- 5: High
- 6: Stop (RO)

Register 28.19. I2C_FIFO_ST_REG (0x0014)

<i>(reserved)</i>		<i>I2C_SLAVE_RW_POINT</i>				<i>(reserved)</i>		<i>I2C_TXFIFO_WADDR</i>		<i>I2C_TXFIFO_RADDR</i>		<i>I2C_RXFIFO_WADDR</i>		<i>I2C_RXFIFO_RADDR</i>	
31	30	29	22	21	20	19	15	14	10	9	5	4	0		
0	0	0				0	0	0		0	0		0	Reset	

I2C_RXFIFO_RADDR Represents the offset address of the APB reading from RXFIFO. (RO)**I2C_RXFIFO_WADDR** Represents the offset address of i2c module receiving data and writing to RXFIFO. (RO)**I2C_TXFIFO_RADDR** Represents the offset address of i2c module reading from TXFIFO. (RO)**I2C_TXFIFO_WADDR** Represents the offset address of APB bus writing to TXFIFO. (RO)**I2C_SLAVE_RW_POINT** Represents the offset address in the I2C Slave RAM addressed by I2C Master when in I2C slave mode. (RO)

Register 28.20. I2C_DATA_REG (0x001C)

(reserved)	I2C_FIFO_RDATA
31	8 7 0
0 0	0
Reset	

I2C_FIFO_RDATA Represents the value of RXFIFO read data. (RO)

Register 28.21. I2C_INT_RAW_REG (0x0020)

(reserved)	I2C_SLAVE_ADDR_UNMATCH_INT_RAW	I2C_SLAVE_CALL_INT_RAW	I2C_SLAVE_STRETCH_INT_RAW	I2C_DET_START_INT_RAW	I2C_SCL_MAIN_ST_TO_INT_RAW	I2C_SCL_ST_TO_INT_RAW	I2C_RXFIFO_UDF_INT_RAW	I2C_TXFIFO_UDF_INT_RAW	I2C_NACK_INT_RAW	I2C_TRANS_START_INT_RAW	I2C_TIME_OUT_INT_RAW	I2C_TRANS_COMPLETE_INT_RAW	I2C_MST_TXFIFO_UDF_INT_RAW	I2C_ARBITRATION_LOST_INT_RAW	I2C_BYTE_TRANS_DONE_INT_RAW	I2C_END_DETECT_INT_RAW	I2C_RXFIFO_OVF_INT_RAW	I2C_TXFIFO_OVF_INT_RAW	I2C_RXFIFO_WM_INT_RAW	I2C_TXFIFO_WM_INT_RAW	
31	19	18	17	16	15	14	13	12	11	10	9	8	7	6	5	4	3	2	1	0	
0 0	0	0	0	0	0	0	0	0	0	0	0	0	0	0	0	0	0	0	0	1	0
Reset																					

I2C_RXFIFO_WM_INT_RAW The raw interrupt status of I2C_RXFIFO_WM_INT interrupt. (R/SS/WTC)

I2C_TXFIFO_WM_INT_RAW The raw interrupt status of I2C_TXFIFO_WM_INT interrupt. (R/SS/WTC)

I2C_RXFIFO_OVF_INT_RAW The raw interrupt status of I2C_RXFIFO_OVF_INT interrupt. (R/SS/WTC)

I2C_END_DETECT_INT_RAW The raw interrupt status of the I2C_END_DETECT_INT interrupt. (R/SS/WTC)

I2C_BYTE_TRANS_DONE_INT_RAW The raw interrupt status of the I2C_END_DETECT_INT interrupt. (R/SS/WTC)

I2C_ARBITRATION_LOST_INT_RAW The raw interrupt status of the I2C_ARBITRATION_LOST_INT interrupt. (R/SS/WTC)

I2C_MST_TXFIFO_UDF_INT_RAW The raw interrupt status of I2C_TRANS_COMPLETE_INT interrupt. (R/SS/WTC)

I2C_TRANS_COMPLETE_INT_RAW The raw interrupt status of the I2C_TRANS_COMPLETE_INT interrupt. (R/SS/WTC)

Continued on the next page...

Register 28.21. I2C_INT_RAW_REG (0x0020)

Continued from the previous page...

I2C_TIME_OUT_INT_RAW The raw interrupt status of the I2C_TIME_OUT_INT interrupt.
(R/SS/WTC)

I2C_TRANS_START_INT_RAW The raw interrupt status of the I2C_TRANS_START_INT interrupt.
(R/SS/WTC)

I2C_NACK_INT_RAW The raw interrupt status of I2C_SLAVE_STRETCH_INT interrupt. (R/SS/WTC)

I2C_TXFIFO_OVF_INT_RAW The raw interrupt status of I2C_TXFIFO_OVF_INT interrupt.
(R/SS/WTC)

I2C_RXFIFO_UDF_INT_RAW The raw interrupt status of I2C_RXFIFO_UDF_INT interrupt.
(R/SS/WTC)

I2C_SCL_ST_TO_INT_RAW The raw interrupt status of I2C_SCL_ST_TO_INT interrupt. (R/SS/WTC)

I2C_SCL_MAIN_ST_TO_INT_RAW The raw interrupt status of I2C_SCL_MAIN_ST_TO_INT interrupt.
(R/SS/WTC)

I2C_DET_START_INT_RAW The raw interrupt status of I2C_DET_START_INT interrupt. (R/SS/WTC)

I2C_SLAVE_STRETCH_INT_RAW The raw interrupt status of I2C_SLAVE_STRETCH_INT interrupt.
(R/SS/WTC)

I2C_GENERAL_CALL_INT_RAW The raw interrupt status of I2C_GENARAL_CALL_INT interrupt.
(R/SS/WTC)

I2C_SLAVE_ADDR_UNMATCH_INT_RAW The raw interrupt status of I2C_SLAVE_ADDR_UNMATCH_INT_RAW interrupt. (R/SS/WTC)

Register 28.22. I2C_INT_CLR_REG (0x0024)

(reserved)																			<div style="display: flex; justify-content: space-between;"> <div style="writing-mode: vertical-rl; transform: rotate(180deg);">I2C_SLAVE_ADDR_UNMATCH_INT_CLR</div> <div style="writing-mode: vertical-rl; transform: rotate(180deg);">I2C_GENERAL_CALL_INT_CLR</div> <div style="writing-mode: vertical-rl; transform: rotate(180deg);">I2C_SLAVE_STRETCH_INT_CLR</div> <div style="writing-mode: vertical-rl; transform: rotate(180deg);">I2C_DET_START_INT_CLR</div> <div style="writing-mode: vertical-rl; transform: rotate(180deg);">I2C_SCL_MAIN_ST_TO_INT_CLR</div> <div style="writing-mode: vertical-rl; transform: rotate(180deg);">I2C_SCL_ST_TO_INT_CLR</div> <div style="writing-mode: vertical-rl; transform: rotate(180deg);">I2C_RXFIFO_UDF_INT_CLR</div> <div style="writing-mode: vertical-rl; transform: rotate(180deg);">I2C_TXFIFO_OVF_INT_CLR</div> <div style="writing-mode: vertical-rl; transform: rotate(180deg);">I2C_NACK_INT_CLR</div> <div style="writing-mode: vertical-rl; transform: rotate(180deg);">I2C_TRANS_START_INT_CLR</div> <div style="writing-mode: vertical-rl; transform: rotate(180deg);">I2C_TIME_OUT_INT_CLR</div> <div style="writing-mode: vertical-rl; transform: rotate(180deg);">I2C_TRANS_COMPLETE_INT_CLR</div> <div style="writing-mode: vertical-rl; transform: rotate(180deg);">I2C_MST_TXFIFO_UDF_INT_CLR</div> <div style="writing-mode: vertical-rl; transform: rotate(180deg);">I2C_ARBITRATION_LOST_INT_CLR</div> <div style="writing-mode: vertical-rl; transform: rotate(180deg);">I2C_BYTE_TRANS_DONE_INT_CLR</div> <div style="writing-mode: vertical-rl; transform: rotate(180deg);">I2C_END_DETECT_INT_CLR</div> <div style="writing-mode: vertical-rl; transform: rotate(180deg);">I2C_RXFIFO_WM_INT_CLR</div> <div style="writing-mode: vertical-rl; transform: rotate(180deg);">I2C_TXFIFO_WM_INT_CLR</div> </div>																					
31																				19	18	17	16	15	14	13	12	11	10	9	8	7	6	5	4	3	2	1	0	Reset
0																																								

- I2C_RXFIFO_WM_INT_CLR** Write 1 to clear I2C_RXFIFO_WM_INT interrupt. (WT)
- I2C_TXFIFO_WM_INT_CLR** Write 1 to clear I2C_TXFIFO_WM_INT interrupt. (WT)
- I2C_RXFIFO_OVF_INT_CLR** Write 1 to clear I2C_RXFIFO_OVF_INT interrupt. (WT)
- I2C_END_DETECT_INT_CLR** Write 1 to clear the I2C_END_DETECT_INT interrupt. (WT)
- I2C_BYTE_TRANS_DONE_INT_CLR** Write 1 to clear the I2C_END_DETECT_INT interrupt. (WT)
- I2C_ARBITRATION_LOST_INT_CLR** Write 1 to clear the I2C_ARBITRATION_LOST_INT interrupt. (WT)
- I2C_MST_TXFIFO_UDF_INT_CLR** Write 1 to clear I2C_TRANS_COMPLETE_INT interrupt. (WT)
- I2C_TRANS_COMPLETE_INT_CLR** Write 1 to clear the I2C_TRANS_COMPLETE_INT interrupt. (WT)
- I2C_TIME_OUT_INT_CLR** Write 1 to clear the I2C_TIME_OUT_INT interrupt. (WT)
- I2C_TRANS_START_INT_CLR** Write 1 to clear the I2C_TRANS_START_INT interrupt. (WT)
- I2C_NACK_INT_CLR** Write 1 to clear I2C_SLAVE_STRETCH_INT interrupt. (WT)
- I2C_TXFIFO_OVF_INT_CLR** Write 1 to clear I2C_TXFIFO_OVF_INT interrupt. (WT)
- I2C_RXFIFO_UDF_INT_CLR** Write 1 to clear I2C_RXFIFO_UDF_INT interrupt. (WT)
- I2C_SCL_ST_TO_INT_CLR** Write 1 to clear I2C_SCL_ST_TO_INT interrupt. (WT)
- I2C_SCL_MAIN_ST_TO_INT_CLR** Write 1 to clear I2C_SCL_MAIN_ST_TO_INT interrupt. (WT)
- I2C_DET_START_INT_CLR** Write 1 to clear I2C_DET_START_INT interrupt. (WT)
- I2C_SLAVE_STRETCH_INT_CLR** Write 1 to clear I2C_SLAVE_STRETCH_INT interrupt. (WT)
- I2C_GENERAL_CALL_INT_CLR** Write 1 to clear I2C_GENARAL_CALL_INT interrupt. (WT)
- I2C_SLAVE_ADDR_UNMATCH_INT_CLR** Write 1 to clear I2C_SLAVE_ADDR_UNMATCH_INT_RAW interrupt. (WT)

Register 28.23. I2C_INT_ENA_REG (0x0028)

31																			19	18	17	16	15	14	13	12	11	10	9	8	7	6	5	4	3	2	1	0	
(reserved)																			I2C_SLAVE_ADDR_UNMATCH_INT_ENA I2C_GENERAL_CALL_INT_ENA I2C_SLAVE_STRETCH_INT_ENA I2C_DET_START_INT_ENA I2C_SCL_MAIN_ST_TO_INT_ENA I2C_SCL_MAIN_ST_TO_INT_ENA I2C_RXFIFO_UDF_INT_ENA I2C_TXFIFO_UDF_INT_ENA I2C_NACK_INT_ENA I2C_TRANS_START_INT_ENA I2C_TIME_OUT_INT_ENA I2C_TRANS_COMPLETE_INT_ENA I2C_MST_TXFIFO_UDF_INT_ENA I2C_ARBITRATION_LOST_INT_ENA I2C_BYTE_TRANS_DONE_INT_ENA I2C_END_DETECT_INT_ENA I2C_RXFIFO_OVF_INT_ENA I2C_TXFIFO_WM_INT_ENA I2C_RXFIFO_WM_INT_ENA																			Reset	
0 0																																							

I2C_RXFIFO_WM_INT_ENA Write 1 to enable I2C_RXFIFO_WM_INT interrupt. (R/W)

I2C_TXFIFO_WM_INT_ENA Write 1 to enable I2C_TXFIFO_WM_INT interrupt. (R/W)

I2C_RXFIFO_OVF_INT_ENA Write 1 to enable I2C_RXFIFO_OVF_INT interrupt. (R/W)

I2C_END_DETECT_INT_ENA Write 1 to enable the I2C_END_DETECT_INT interrupt. (R/W)

I2C_BYTE_TRANS_DONE_INT_ENA Write 1 to enable the I2C_BYTE_TRANS_DONE_INT interrupt. (R/W)

I2C_ARBITRATION_LOST_INT_ENA Write 1 to enable the I2C_ARBITRATION_LOST_INT interrupt. (R/W)

I2C_MST_TXFIFO_UDF_INT_ENA Write 1 to enable I2C_TRANS_COMPLETE_INT interrupt. (R/W)

I2C_TRANS_COMPLETE_INT_ENA Write 1 to enable the I2C_TRANS_COMPLETE_INT interrupt. (R/W)

I2C_TIME_OUT_INT_ENA Write 1 to enable the I2C_TIME_OUT_INT interrupt. (R/W)

I2C_TRANS_START_INT_ENA Write 1 to enable the I2C_TRANS_START_INT interrupt. (R/W)

I2C_NACK_INT_ENA Write 1 to enable I2C_SLAVE_STRETCH_INT interrupt. (R/W)

I2C_TXFIFO_OVF_INT_ENA Write 1 to enable I2C_TXFIFO_OVF_INT interrupt. (R/W)

I2C_RXFIFO_UDF_INT_ENA Write 1 to enable I2C_RXFIFO_UDF_INT interrupt. (R/W)

I2C_SCL_ST_TO_INT_ENA Write 1 to enable I2C_SCL_ST_TO_INT interrupt. (R/W)

I2C_SCL_MAIN_ST_TO_INT_ENA Write 1 to enable I2C_SCL_MAIN_ST_TO_INT interrupt. (R/W)

I2C_DET_START_INT_ENA Write 1 to enable I2C_DET_START_INT interrupt. (R/W)

I2C_SLAVE_STRETCH_INT_ENA Write 1 to enable I2C_SLAVE_STRETCH_INT interrupt. (R/W)

I2C_GENERAL_CALL_INT_ENA Write 1 to enable I2C_GENERAL_CALL_INT interrupt. (R/W)

I2C_SLAVE_ADDR_UNMATCH_INT_ENA Write 1 to enable I2C_SLAVE_ADDR_UNMATCH_INT interrupt. (R/W)

Register 28.24. I2C_INT_STATUS_REG (0x002C)

(reserved)																			I2C_SLAVE_ADDR_UNMATCH_INT_ST	I2C_GENERAL_CALL_INT_ST	I2C_SLAVE_STRETCH_INT_ST	I2C_DET_START_INT_ST	I2C_SCL_MAIN_INT_ST	I2C_SCL_ST_TO_INT_ST	I2C_RXFIFO_UDF_INT_ST	I2C_NACK_OVF_INT_ST	I2C_TRANS_INT_ST	I2C_TIME_OUT_INT_ST	I2C_TRANS_START_INT_ST	I2C_MST_TXFIFO_UDF_INT_ST	I2C_ARBTRATION_LOST_INT_ST	I2C_BYTE_TRANS_DONE_INT_ST	I2C_END_DETECT_INT_ST	I2C_RXFIFO_OVF_INT_ST	I2C_RXFIFO_WM_INT_ST	I2C_RXFIFO_WM_INT_ST
31																																				
0	0	0	0	0	0	0	0	0	0	0	0	0	0	0	0	0	0	0	0																	

Reset

I2C_RXFIFO_WM_INT_ST The masked interrupt status status of I2C_RXFIFO_WM_INT interrupt. (RO)

I2C_TXFIFO_WM_INT_ST The masked interrupt status status of I2C_TXFIFO_WM_INT interrupt. (RO)

I2C_RXFIFO_OVF_INT_ST The masked interrupt status status of I2C_RXFIFO_OVF_INT interrupt. (RO)

I2C_END_DETECT_INT_ST The masked interrupt status status of the I2C_END_DETECT_INT interrupt. (RO)

I2C_BYTE_TRANS_DONE_INT_ST The masked interrupt status status of the I2C_END_DETECT_INT interrupt. (RO)

I2C_ARBTRATION_LOST_INT_ST The masked interrupt status status of the I2C_ARBTRATION_LOST_INT interrupt. (RO)

I2C_MST_TXFIFO_UDF_INT_ST The masked interrupt status status of I2C_TRANS_COMPLETE_INT interrupt. (RO)

I2C_TRANS_COMPLETE_INT_ST The masked interrupt status status of the I2C_TRANS_COMPLETE_INT interrupt. (RO)

I2C_TIME_OUT_INT_ST The masked interrupt status status of the I2C_TIME_OUT_INT interrupt. (RO)

I2C_TRANS_START_INT_ST The masked interrupt status status of the I2C_TRANS_START_INT interrupt. (RO)

I2C_NACK_INT_ST The masked interrupt status status of I2C_SLAVE_STRETCH_INT interrupt. (RO)

I2C_TXFIFO_OVF_INT_ST The masked interrupt status status of I2C_TXFIFO_OVF_INT interrupt. (RO)

Continued on the next page...

Register 28.24. I2C_INT_STATUS_REG (0x002C)

Continued from the previous page...

I2C_RXFIFO_UDF_INT_ST The masked interrupt status status of I2C_RXFIFO_UDF_INT interrupt.
(RO)

I2C_SCL_ST_TO_INT_ST The masked interrupt status status of I2C_SCL_ST_TO_INT interrupt.
(RO)

I2C_SCL_MAIN_ST_TO_INT_ST The masked interrupt status status of I2C_SCL_MAIN_ST_TO_INT interrupt. (RO)

I2C_DET_START_INT_ST The masked interrupt status status of I2C_DET_START_INT interrupt. (RO)

I2C_SLAVE_STRETCH_INT_ST The masked interrupt status status of I2C_SLAVE_STRETCH_INT interrupt. (RO)

I2C_GENERAL_CALL_INT_ST The masked interrupt status status of I2C_GENERAL_CALL_INT interrupt. (RO)

I2C_SLAVE_ADDR_UNMATCH_INT_ST The masked interrupt status status of I2C_SLAVE_ADDR_UNMATCH_INT interrupt. (RO)

Register 28.25. I2C_COMD0_REG (0x0058)

<i>I2C_COMMAND0_DONE</i>														<i>(reserved)</i>														<i>I2C_COMMAND0</i>													
31	30													14	13													0													
0														0														Reset													

I2C_COMMAND0 Configures command 0.

It consists of three parts:

op_code is the command

0: RSTART

1: WRITE

2: READ

3: STOP

4: END.

Byte_num represents the number of bytes that need to be sent or received.

ack_check_en, ack_exp and ack are used to control the ACK bit. See I2C cmd structure 28-6 for more information.

(R/W)

I2C_COMMAND0_DONE Represents whether command 0 is done in I2C Master mode.

0: Not done

1: Done

(R/W/SS)

Register 28.26. I2C_COMD1_REG (0x005C)

<i>I2C_COMMAND1_DONE</i>														<i>(reserved)</i>														<i>I2C_COMMAND1</i>													
31	30													14	13													0													
0														0														Reset													

I2C_COMMAND1 Configures command 1.

See details in I2C_CMD0_REG[13:0]. (R/W)

I2C_COMMAND1_DONE Represents whether command 1 is done in I2C Master mode.

0: Not done

1: Done

(R/W/SS)

Register 28.27. I2C_COMD2_REG (0x0060)

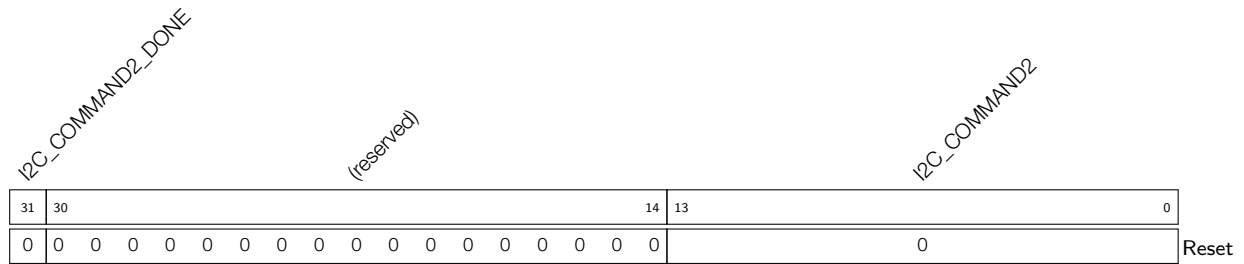

I2C_COMMAND2 Configures command 2. See details in I2C_CMD0_REG[13:0]. (R/W)

I2C_COMMAND2_DONE Represents whether command 2 is done in I2C Master mode.

0: Not done

1: Done

(R/W/SS)

Register 28.28. I2C_COMD3_REG (0x0064)

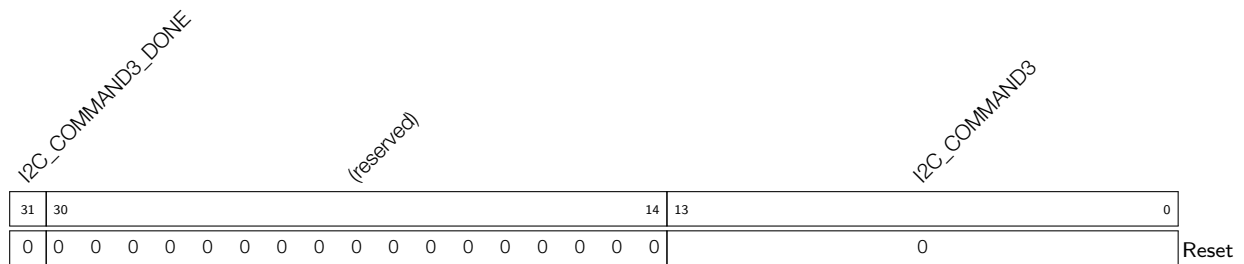

I2C_COMMAND3 Configures command 3. See details in I2C_CMD0_REG[13:0]. (R/W)

I2C_COMMAND3_DONE Represents whether command 3 is done in I2C Master mode.

0: Not done

1: Done

(R/W/SS)

Register 28.29. I2C_COMD4_REG (0x0068)

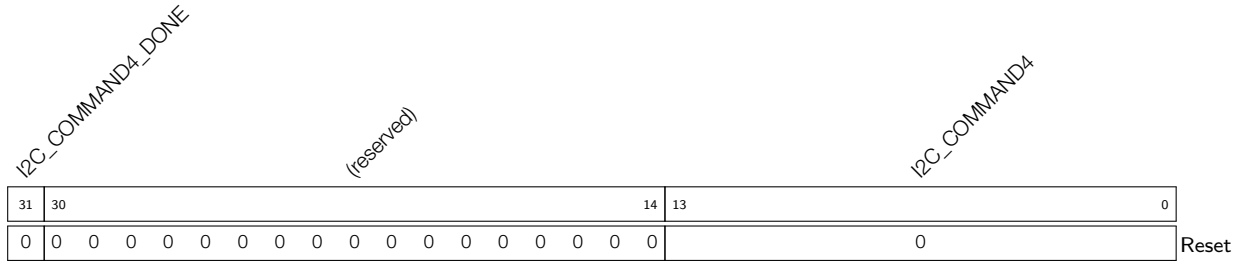

I2C_COMMAND4 Configures command 4. See details in I2C_CMD0_REG[13:0]. (R/W)

I2C_COMMAND4_DONE Represents whether command 4 is done in I2C Master mode.

0: Not done

1: Done

(R/W/SS)

Register 28.30. I2C_COMD5_REG (0x006C)

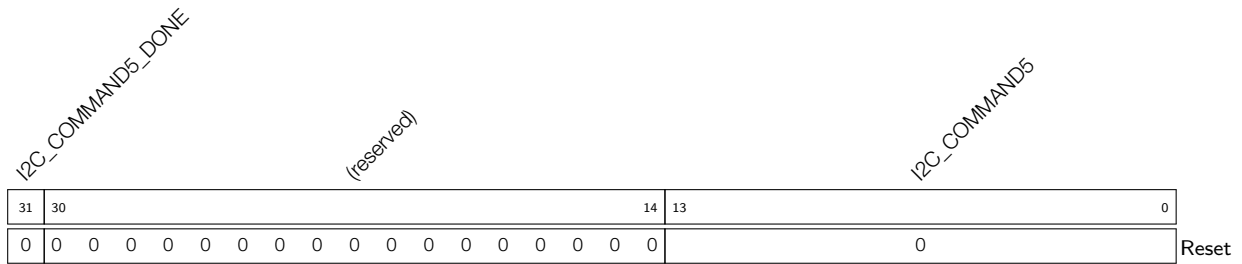

I2C_COMMAND5 Configures command 5. See details in I2C_CMD0_REG[13:0]. (R/W)

I2C_COMMAND5_DONE Represents whether command 5 is done in I2C Master mode.

0: Not done

1: Done

(R/W/SS)

Register 28.31. I2C_COMD6_REG (0x0070)

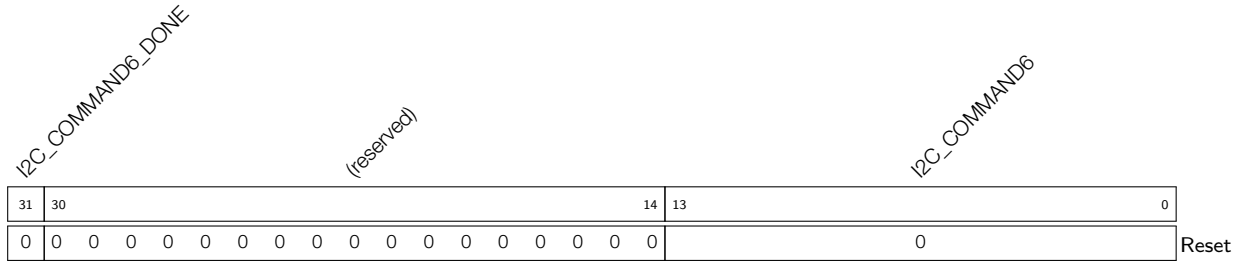

I2C_COMMAND6 Configures command 6. See details in I2C_CMD0_REG[13:0]. (R/W)

I2C_COMMAND6_DONE Represents whether command 6 is done in I2C Master mode.

0: Not done

1: Done

(R/W/SS)

Register 28.32. I2C_COMD7_REG (0x0074)

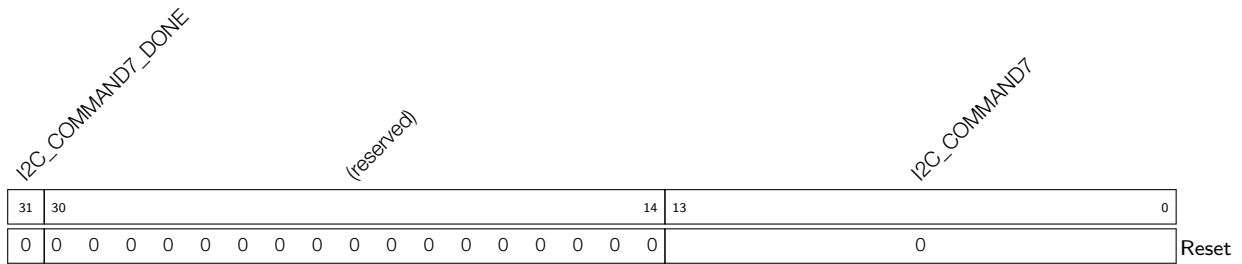

I2C_COMMAND7 Configures command 7. See details in I2C_CMD0_REG[13:0]. (R/W)

I2C_COMMAND7_DONE Represents whether command 7 is done in I2C Master mode.

0: Not done

1: Done

(R/W/SS)

Register 28.33. I2C_DATE_REG (0x00F8)

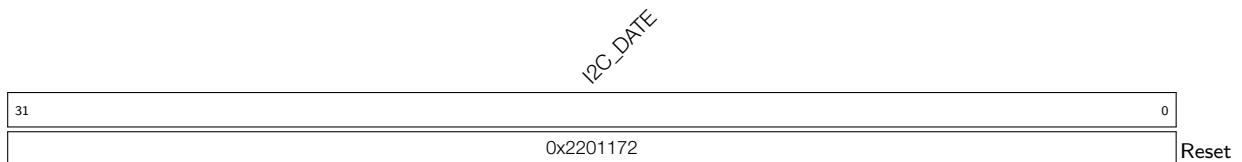

I2C_DATE Version control register. (R/W)

Register 28.34. I2C_TXFIFO_START_ADDR_REG (0x0100)

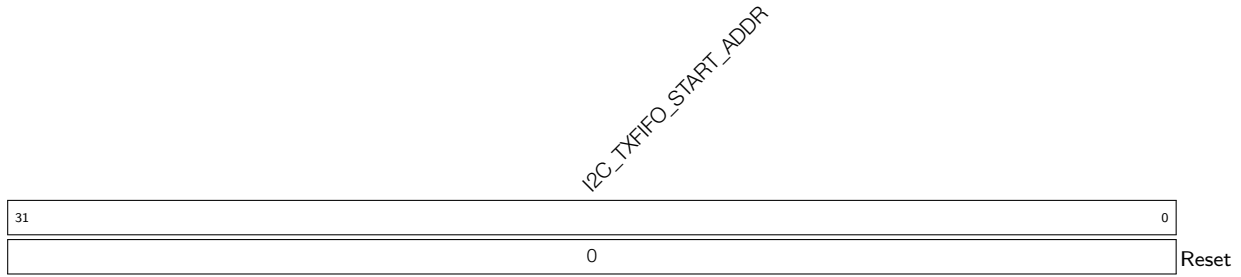

I2C_TXFIFO_START_ADDR Represents the I2C txfifo first address. (HRO)

Register 28.35. I2C_RXFIFO_START_ADDR_REG (0x0180)

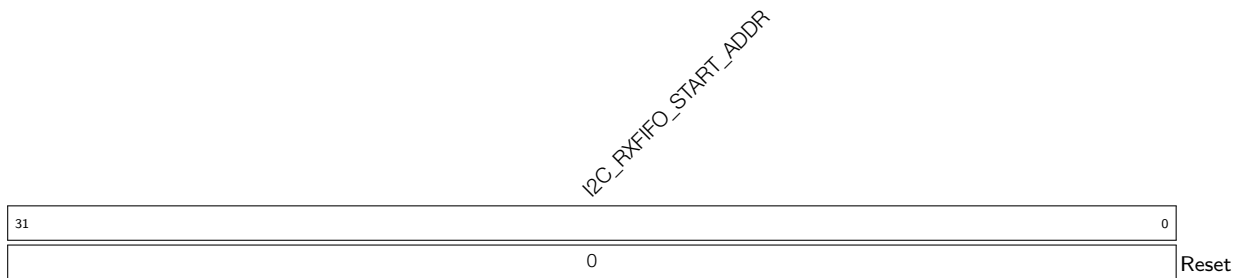

I2C_RXFIFO_START_ADDR Represents the I2C rxfifo first address. (HRO)

28.11.1 LP_I2C

Register 28.36. LP_I2C_SCL_LOW_PERIOD_REG (0x0000)

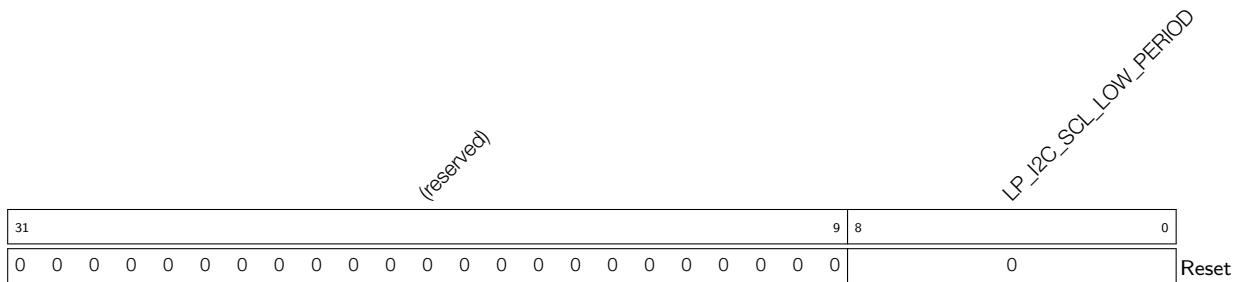

LP_I2C_SCL_LOW_PERIOD Configures the low level width of the SCL Clock in master mode.
 Measurement unit: i2c_sclk
 (R/W)

Register 28.37. LP_I2C_SDA_HOLD_REG (0x0030)

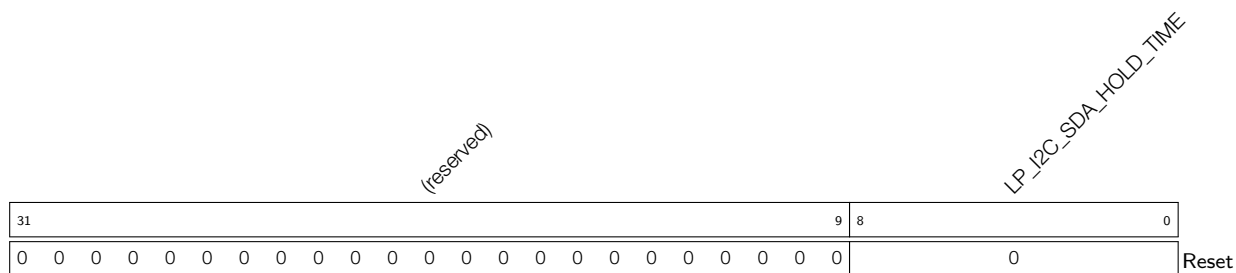

LP_I2C_SDA_HOLD_TIME Configures the time to hold the data after the falling edge of SCL.
 Measurement unit: i2c_sclk
 (R/W)

Register 28.38. LP_I2C_SDA_SAMPLE_REG (0x0034)

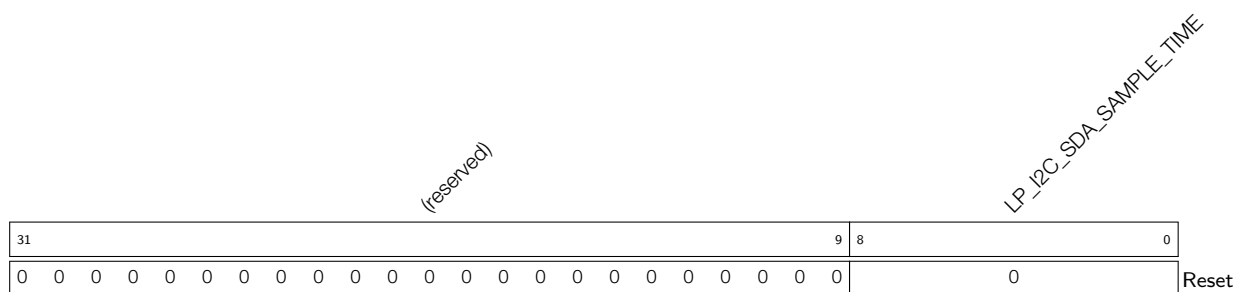

LP_I2C_SDA_SAMPLE_TIME Configures the time for sampling SDA.
 Measurement unit: i2c_sclk
 (R/W)

Register 28.39. LP_I2C_SCL_HIGH_PERIOD_REG (0x0038)

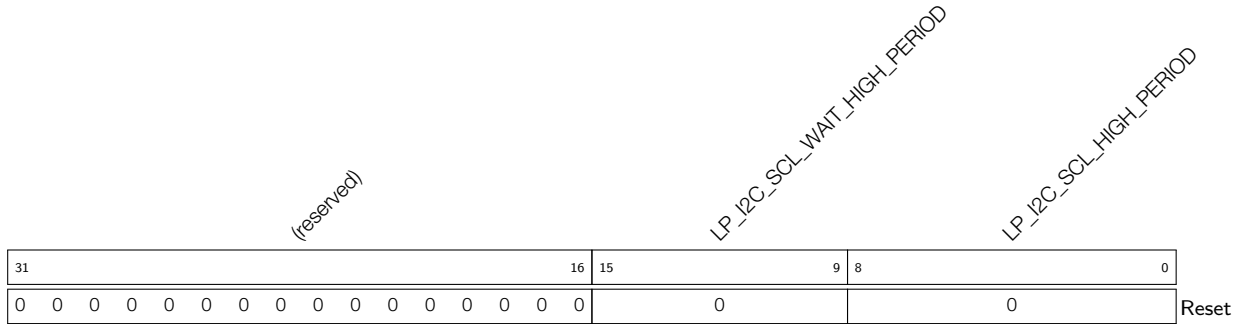

LP_I2C_SCL_HIGH_PERIOD Configures for how long SCL remains high in master mode.

Measurement unit: i2c_sclk

(R/W)

LP_I2C_SCL_WAIT_HIGH_PERIOD Configures the SCL_FSM's waiting period for SCL high level in master mode.

Measurement unit: i2c_sclk

(R/W)

Register 28.40. LP_I2C_SCL_START_HOLD_REG (0x0040)

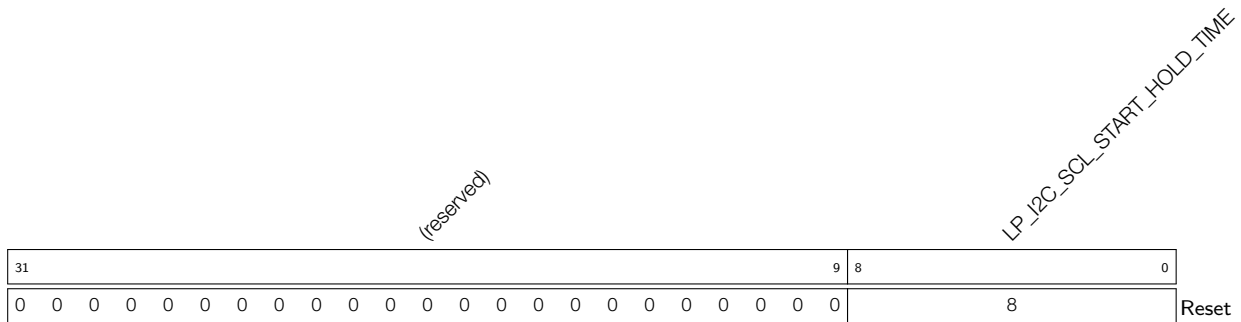

LP_I2C_SCL_START_HOLD_TIME Configures the time between the falling edge of SDA and the falling edge of SCL for a START condition.

Measurement unit: i2c_sclk

(R/W)

Register 28.41. LP_I2C_SCL_RSTART_SETUP_REG (0x0044)

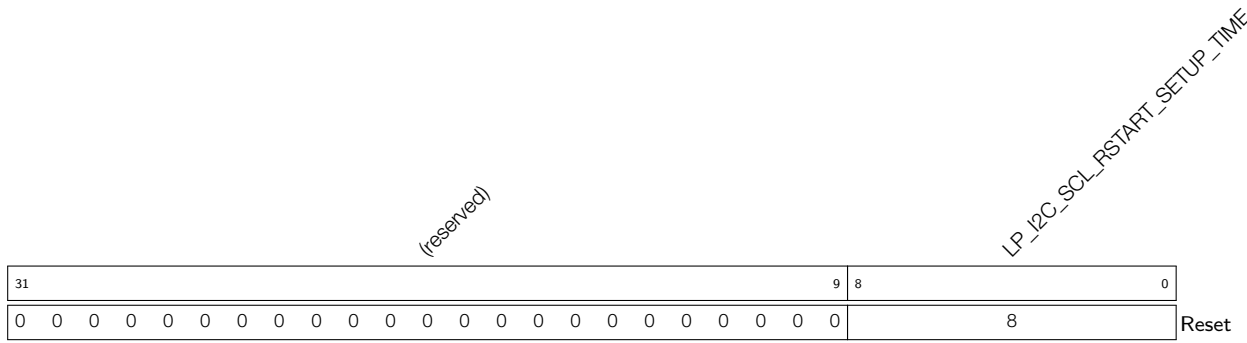

LP_I2C_SCL_RSTART_SETUP_TIME Configures the time between the positive edge of SCL and the negative edge of SDA for a RESTART condition.
 Measurement unit: i2c_sclk
 (R/W)

Register 28.42. LP_I2C_SCL_STOP_HOLD_REG (0x0048)

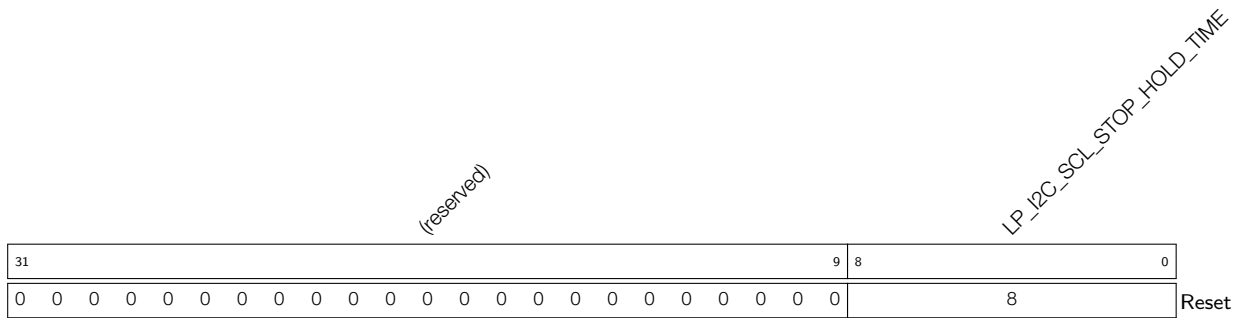

LP_I2C_SCL_STOP_HOLD_TIME Configures the delay after the STOP condition.
 Measurement unit: i2c_sclk
 (R/W)

Register 28.43. LP_I2C_SCL_STOP_SETUP_REG (0x004C)

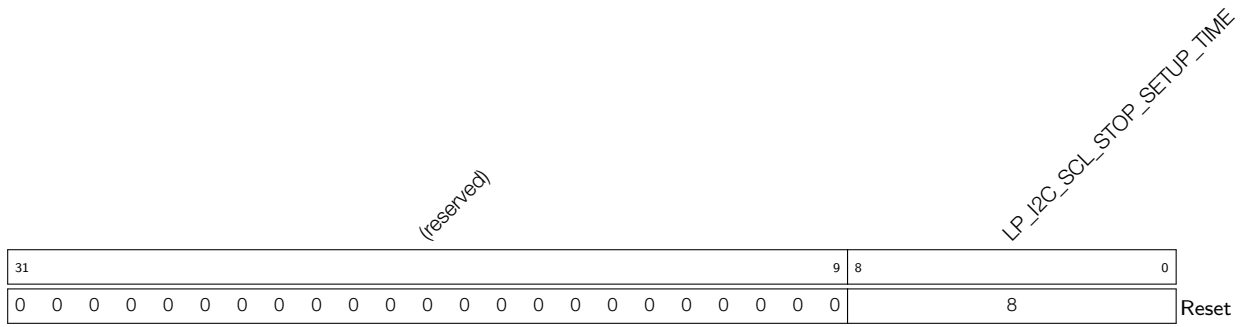

LP_I2C_SCL_STOP_SETUP_TIME Configures the time between the rising edge of SCL and the rising edge of SDA.
 Measurement unit: i2c_sclk
 (R/W)

Register 28.44. LP_I2C_SCL_ST_TIME_OUT_REG (0x0078)

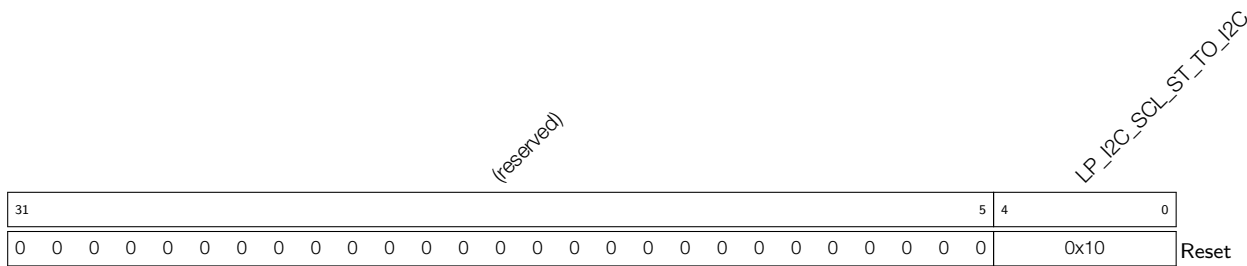

LP_I2C_SCL_ST_TO_I2C Configures the threshold value of SCL_FSM state unchanged period. It should be no more than 23.
 Measurement unit: i2c_sclk
 (R/W)

Register 28.45. LP_I2C_SCL_MAIN_ST_TIME_OUT_REG (0x007C)

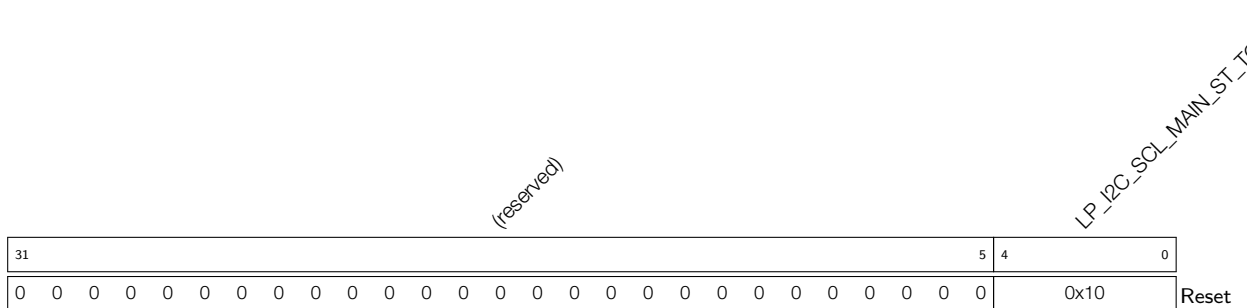

LP_I2C_SCL_MAIN_ST_TO_I2C Configures the threshold value of SCL_MAIN_FSM state unchanged period. It should be no more than 23.
 Measurement unit: i2c_sclk
 (R/W)

Register 28.46. LP_I2C_CTR_REG (0x0004)

(reserved)												LP_I2C_CONF_UPGATE LP_I2C_FSM_RST LP_I2C_ARBITRATION_EN LP_I2C_CLK_EN LP_I2C_RX_LSB_FIRST LP_I2C_TX_LSB_FIRST (reserved) LP_I2C_TRANS_START LP_I2C_SAMPLE_SCL_LEVEL (reserved)													
31												12	11	10	9	8	7	6	5	4	3	2	1	0	
0	0	0	0	0	0	0	0	0	0	0	0	0	0	1	0	0	0	0	0	1	0	0	0	0	Reset

LP_I2C_SAMPLE_SCL_LEVEL Configures the sample mode for SDA.

- 1: Sample SDA data on the SCL low level.
- 0: Sample SDA data on the SCL high level.

(R/W)

LP_I2C_RX_FULL_ACK_LEVEL Configures the ACK value that needs to be sent by master when the rx_fifo_cnt has reached the threshold. (R/W)

LP_I2C_TRANS_START Configures to start sending the data in txfifo for slave.

- 0: No effect
- 1: Start

(WT)

LP_I2C_TX_LSB_FIRST Configures to control the sending order for data to be sent.

- 1: send data from the least significant bit
- 0: send data from the most significant bit

(R/W)

LP_I2C_RX_LSB_FIRST Configures to control the storage order for received data.

- 1: receive data from the least significant bit
- 0: receive data from the most significant bit

(R/W)

LP_I2C_CLK_EN Configures whether to gate clock signal for registers.

- 0: Support clock only when registers are read or written to by software
- 1: Force clock on for registers.

(R/W)

LP_I2C_ARBITRATION_EN Configures to enable I2C bus arbitration detection.

- 0: No effect
- 1: Enable

(R/W)

LP_I2C_FSM_RST Configures to reset the SCL_FSM.

- 0: No effect
- 1: Reset

(WT)

LP_I2C_CONF_UPGATE Configures this bit for synchronization.

- 0: No effect
- 1: Synchronize

(WT)

Register 28.47. LP_I2C_TO_REG (0x000C)

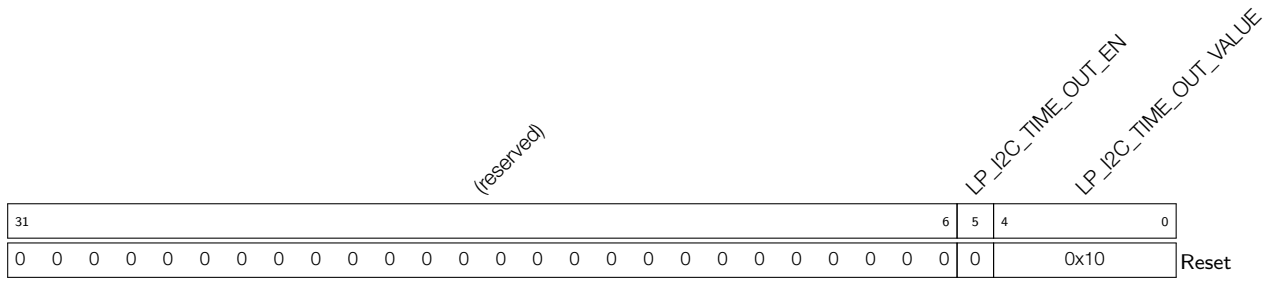

LP_I2C_TIME_OUT_VALUE Configures the timeout threshold period for SCL stucking at high or low level. The actual period is $2^{(reg_time_out_value)}$.
 Measurement unit: i2c_sclk.
 (R/W)

LP_I2C_TIME_OUT_EN Configures to enable time out control.
 0: No effect
 1: Enable
 (R/W)

Register 28.48. LP_I2C_FIFO_CONF_REG (0x0018)

(reserved)										LP_I2C_FIFO_PRT_EN				LP_I2C_TX_FIFO_RST				LP_I2C_RX_FIFO_RST				LP_I2C_NONFIFO_EN				LP_I2C_TXFIFO_WM_THRHD				LP_I2C_RXFIFO_WM_THRHD				
31															15	14	13	12	11	10	9	8					5	4	3	0				
0															0	0	0	0	0	0	0	0	0	0	0x2				0	0x6				Reset

LP_I2C_RXFIFO_WM_THRHD Configures the water mark threshold of RXFIFO in nonfifo access mode. When LP_I2C_FIFO_PRT_EN is 1 and rx FIFO counter is bigger than LP_I2C_RXFIFO_WM_THRHD[4:0], LP_I2C_RXFIFO_WM_INT_RAW bit will be valid. (R/W)

LP_I2C_TXFIFO_WM_THRHD Configures the water mark threshold of TXFIFO in nonfifo access mode. When LP_I2C_FIFO_PRT_EN is 1 and rx FIFO counter is bigger than LP_I2C_TXFIFO_WM_THRHD[4:0], LP_I2C_TXFIFO_WM_INT_RAW bit will be valid. (R/W)

LP_I2C_NONFIFO_EN Configures to enable APB nonfifo access. (R/W)

LP_I2C_RX_FIFO_RST Configures to reset RXFIFO.

0: No effect

1: Reset

(R/W)

LP_I2C_TX_FIFO_RST Configures to reset TXFIFO. 0: No effect

1: Reset

(R/W)

LP_I2C_FIFO_PRT_EN Configures to enable FIFO pointer in non-fifo access mode. This bit controls the valid bits and the TX/RX FIFO overflow, underflow, full and empty interrupts.

0: No effect

1: Enable

(R/W)

Register 28.49. LP_I2C_FILTER_CFG_REG (0x0050)

(reserved)										LP_I2C_SDA_FILTER_EN		LP_I2C_SCL_FILTER_EN		LP_I2C_SDA_FILTER_THRES		LP_I2C_SCL_FILTER_THRES	
31											10	9	8	7	4	3	0
0 0										1	1	0		0		Reset	

LP_I2C_SCL_FILTER_THRES Configures the threshold pulse width to be filtered on SCL. When a pulse on the SCL input has smaller width than this value, the I2C controller will ignore that pulse.

Measurement unit: i2c_sclk

(R/W)

LP_I2C_SDA_FILTER_THRES Configures the threshold pulse width to be filtered on SDA. When a pulse on the SDA input has smaller width than this value, the I2C controller will ignore that pulse.

Measurement unit: i2c_sclk

(R/W)

LP_I2C_SCL_FILTER_EN Configures to enable the filter function for SCL.

0: No effect

1: Enable

(R/W)

LP_I2C_SDA_FILTER_EN Configures to enable the filter function for SDA.

0: No effect

1: Enable

(R/W)

Register 28.50. LP_I2C_SCL_SP_CONF_REG (0x0080)

(reserved)														LP_I2C_SDA_PD_EN LP_I2C_SCL_PD_EN		LP_I2C_SCL_RST_SLV_NUM		LP_I2C_SCL_RST_SLV_EN		
31													8	7	6	5			1	0
0 0												0	0	0		0	0	Reset		

LP_I2C_SCL_RST_SLV_EN Configures to send out SCL pulses when I2C master is IDLE. The number of pulses equals to LP_I2C_SCL_RST_SLV_NUM[4:0]. (R/W/SC)

LP_I2C_SCL_RST_SLV_NUM Configure the pulses of SCL generated in I2C master mode.

Valid when LP_I2C_SCL_RST_SLV_EN is 1.

Measurement unit: i2c_sclk

(R/W)

LP_I2C_SCL_PD_EN Configures to power down the I2C output SCL line.

0: Not power down

1: Not work and power down

Valid only when LP_I2C_SCL_FORCE_OUT is 1

(R/W)

LP_I2C_SDA_PD_EN Configures to power down the I2C output SDA line.

0: Not power down.

1: Not work and power down.

Valid only when LP_I2C_SDA_FORCE_OUT is 1. (R/W)

Register 28.51. LP_I2C_SR_REG (0x0008)

(reserved)	LP_I2C_SCL_STATE_LAST	(reserved)	LP_I2C_SCL_MAIN_STATE_LAST	(reserved)	LP_I2C_TXFIFO_CNT	(reserved)	LP_I2C_RXFIFO_CNT	(reserved)	LP_I2C_BUS_BUSY	LP_I2C_ARB_LOST	(reserved)	LP_I2C_RESP_REC								
31	30	28	27	26	24	23	22	18	17	13	12	8	7	5	4	3	2	1	0	
0	0	0	0	0	0	0	0	0	0	0	0	0	0	0	0	0	0	0	0	Reset

LP_I2C_RESP_REC Represents the received ACK value in master mode or slave mode.

- 0: ACK
 - 1: NACK
- (RO)

LP_I2C_ARB_LOST Represents whether the I2C controller loses control of SCL line.

- 0: No arbitration lost
 - 1: Arbitration lost
- (RO)

LP_I2C_BUS_BUSY Represents the I2C bus state.

- 1: The I2C bus is busy transferring data
 - 0: The I2C bus is in idle state
- (RO)

LP_I2C_RXFIFO_CNT Represents the number of data bytes received in RAM. (RO)

LP_I2C_TXFIFO_CNT Represents the number of data bytes to be sent. (RO)

LP_I2C_SCL_MAIN_STATE_LAST Represents the states of the I2C module state machine.

- 0: Idle
 - 1: Address shift
 - 2: ACK address
 - 3: Rx data
 - 4: Tx data
 - 5: Send ACK
 - 6: Wait ACK
- (RO)

LP_I2C_SCL_STATE_LAST Represents the states of the state machine used to produce SCL.

- 0: Idle
 - 1: Start
 - 2: Negative edge
 - 3: Low
 - 4: Positive edge
 - 5: High
 - 6: Stop
- (RO)

Register 28.52. LP_I2C_FIFO_ST_REG (0x0014)

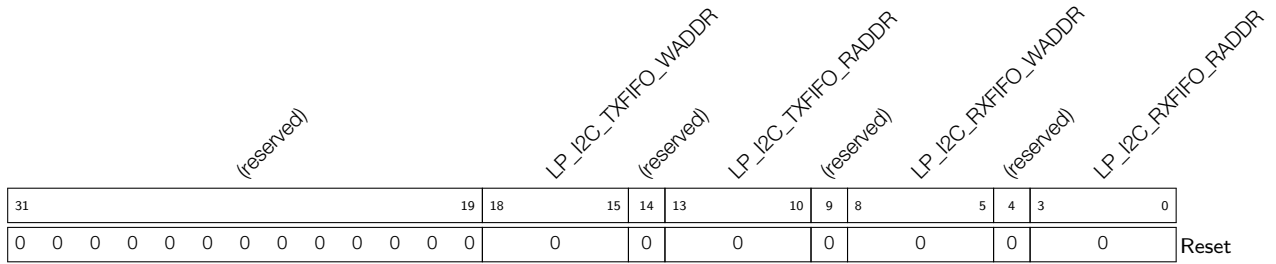

LP_I2C_RXFIFO_RADDR Represents the offset address of the APB reading from RXFIFO (RO)

LP_I2C_RXFIFO_WADDR Represents the offset address of i2c module receiving data and writing to RXFIFO. (RO)

LP_I2C_TXFIFO_RADDR Represents the offset address of i2c module reading from TXFIFO. (RO)

LP_I2C_TXFIFO_WADDR Represents the offset address of APB bus writing to TXFIFO. (RO)

Register 28.53. LP_I2C_DATA_REG (0x001C)

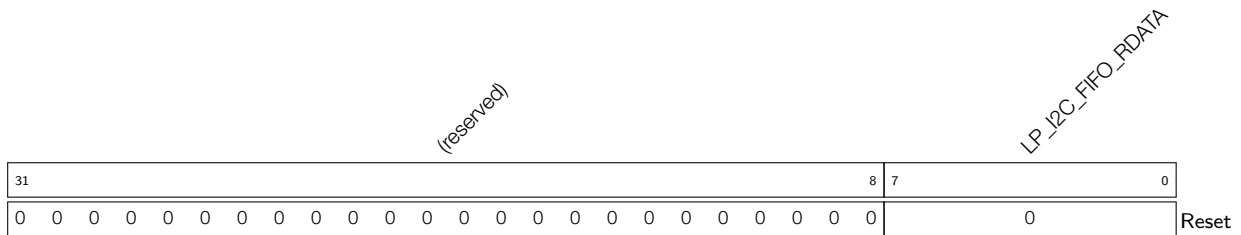

LP_I2C_FIFO_RDATA Represents the value of RXFIFO read data. (RO)

Register 28.54. LP_I2C_INT_RAW_REG (0x0020)

(reserved)																LP_I2C_DET_START_INT_RAW LP_I2C_SCL_MAIN_ST_TO_INT_RAW LP_I2C_SCL_ST_TO_INT_RAW LP_I2C_RXFIFO_UDF_INT_RAW LP_I2C_TXFIFO_UDF_INT_RAW LP_I2C_NACK_INT_RAW LP_I2C_TRANS_INT_RAW LP_I2C_TIME_OUT_INT_RAW LP_I2C_MST_TXFIFO_UDF_INT_RAW LP_I2C_ARBITRATION_LOST_INT_RAW LP_I2C_BYTE_TRANS_DONE_INT_RAW LP_I2C_END_DETECT_INT_RAW LP_I2C_RXFIFO_OVF_INT_RAW LP_I2C_TXFIFO_WM_INT_RAW																
31																16	15	14	13	12	11	10	9	8	7	6	5	4	3	2	1	0
0	0	0	0	0	0	0	0	0	0	0	0	0	0	0	0	0	0	0	0	0	0	0	1	0								

Reset

LP_I2C_RXFIFO_WM_INT_RAW The raw interrupt status of LP_I2C_RXFIFO_WM_INT interrupt. (R/SS/WTC)

LP_I2C_TXFIFO_WM_INT_RAW The raw interrupt status of LP_I2C_TXFIFO_WM_INT interrupt. (R/SS/WTC)

LP_I2C_RXFIFO_OVF_INT_RAW The raw interrupt status of LP_I2C_RXFIFO_OVF_INT interrupt. (R/SS/WTC)

LP_I2C_END_DETECT_INT_RAW The raw interrupt status of the LP_I2C_END_DETECT_INT interrupt. (R/SS/WTC)

LP_I2C_BYTE_TRANS_DONE_INT_RAW The raw interrupt status of the LP_I2C_END_DETECT_INT interrupt. (R/SS/WTC)

LP_I2C_ARBITRATION_LOST_INT_RAW The raw interrupt status of the LP_I2C_ARBITRATION_LOST_INT interrupt. (R/SS/WTC)

LP_I2C_MST_TXFIFO_UDF_INT_RAW The raw interrupt status of LP_I2C_TRANS_COMPLETE_INT interrupt. (R/SS/WTC)

LP_I2C_TRANS_COMPLETE_INT_RAW The raw interrupt status of the LP_I2C_TRANS_COMPLETE_INT interrupt. (R/SS/WTC)

LP_I2C_TIME_OUT_INT_RAW The raw interrupt status of the LP_I2C_TIME_OUT_INT interrupt. (R/SS/WTC)

Continued on the next page...

Register 28.54. LP_I2C_INT_RAW_REG (0x0020)

Continued from the previous page...

LP_I2C_TRANS_START_INT_RAW The raw interrupt status of the LP_I2C_TRANS_START_INT interrupt. (R/SS/WTC)

LP_I2C_NACK_INT_RAW The raw interrupt status of LP_I2C_SLAVE_STRETCH_INT interrupt. (R/SS/WTC)

LP_I2C_TXFIFO_OVF_INT_RAW The raw interrupt status of LP_I2C_TXFIFO_OVF_INT interrupt. (R/SS/WTC)

LP_I2C_RXFIFO_UDF_INT_RAW The raw interrupt status of LP_I2C_RXFIFO_UDF_INT interrupt. (R/SS/WTC)

LP_I2C_SCL_ST_TO_INT_RAW The raw interrupt status of LP_I2C_SCL_ST_TO_INT interrupt. (R/SS/WTC)

LP_I2C_SCL_MAIN_ST_TO_INT_RAW The raw interrupt status of LP_I2C_SCL_MAIN_ST_TO_INT interrupt. (R/SS/WTC)

LP_I2C_DET_START_INT_RAW The raw interrupt status of LP_I2C_DET_START_INT interrupt. (R/SS/WTC)

Register 28.55. LP_I2C_INT_CLR_REG (0x0024)

(reserved)																LP_I2C_DET_START_INT_CLR LP_I2C_SCL_MAIN_ST_TO_INT_CLR LP_I2C_SCL_ST_TO_INT_CLR LP_I2C_RXFIFO_UDF_INT_CLR LP_I2C_TXFIFO_UDF_INT_CLR LP_I2C_NACK_INT_CLR LP_I2C_TRANS_INT_CLR LP_I2C_TIME_OUT_INT_CLR LP_I2C_TRANS_START_INT_CLR LP_I2C_MST_TXFIFO_UDF_INT_CLR LP_I2C_TRANS_COMPLETE_INT_CLR LP_I2C_ARBTRATION_LOST_INT_CLR LP_I2C_BYTE_TRANS_DONE_INT_CLR LP_I2C_END_DETECT_INT_CLR LP_I2C_RXFIFO_OVF_INT_CLR LP_I2C_TXFIFO_WM_INT_CLR LP_I2C_RXFIFO_WM_INT_CLR																	
31																16	15	14	13	12	11	10	9	8	7	6	5	4	3	2	1	0	Reset
0	0	0	0	0	0	0	0	0	0	0	0	0	0	0	0	0	0	0	0	0	0	0	0	0	0	0							

- LP_I2C_RXFIFO_WM_INT_CLR** Write 1 to clear LP_I2C_RXFIFO_WM_INT interrupt. (WT)
- LP_I2C_TXFIFO_WM_INT_CLR** Write 1 to clear LP_I2C_TXFIFO_WM_INT interrupt. (WT)
- LP_I2C_RXFIFO_OVF_INT_CLR** Write 1 to clear LP_I2C_RXFIFO_OVF_INT interrupt. (WT)
- LP_I2C_END_DETECT_INT_CLR** Write 1 to clear the LP_I2C_END_DETECT_INT interrupt. (WT)
- LP_I2C_BYTE_TRANS_DONE_INT_CLR** Write 1 to clear the LP_I2C_END_DETECT_INT interrupt. (WT)
- LP_I2C_ARBITRATION_LOST_INT_CLR** Write 1 to clear the LP_I2C_ARBITRATION_LOST_INT interrupt. (WT)
- LP_I2C_MST_TXFIFO_UDF_INT_CLR** Write 1 to clear LP_I2C_TRANS_COMPLETE_INT interrupt. (WT)
- LP_I2C_TRANS_COMPLETE_INT_CLR** Write 1 to clear the LP_I2C_TRANS_COMPLETE_INT interrupt. (WT)
- LP_I2C_TIME_OUT_INT_CLR** Write 1 to clear the LP_I2C_TIME_OUT_INT interrupt. (WT)
- LP_I2C_TRANS_START_INT_CLR** Write 1 to clear the LP_I2C_TRANS_START_INT interrupt. (WT)
- LP_I2C_NACK_INT_CLR** Write 1 to clear LP_I2C_SLAVE_STRETCH_INT interrupt. (WT)
- LP_I2C_TXFIFO_OVF_INT_CLR** Write 1 to clear LP_I2C_TXFIFO_OVF_INT interrupt. (WT)
- LP_I2C_RXFIFO_UDF_INT_CLR** Write 1 to clear LP_I2C_RXFIFO_UDF_INT interrupt. (WT)
- LP_I2C_SCL_ST_TO_INT_CLR** Write 1 to clear LP_I2C_SCL_ST_TO_INT interrupt. (WT)
- LP_I2C_SCL_MAIN_ST_TO_INT_CLR** Write 1 to clear LP_I2C_SCL_MAIN_ST_TO_INT interrupt. (WT)
- LP_I2C_DET_START_INT_CLR** Write 1 to clear LP_I2C_DET_START_INT interrupt. (WT)

Register 28.56. LP_I2C_INT_ENA_REG (0x0028)

(reserved)																LP_I2C_DET_START_INT_ENA LP_I2C_SCL_MAIN_ST_TO_INT_ENA LP_I2C_SCL_ST_TO_INT_ENA LP_I2C_RXFIFO_UDF_INT_ENA LP_I2C_TXFIFO_UDF_INT_ENA LP_I2C_NACK_INT_ENA LP_I2C_TRANS_INT_ENA LP_I2C_TIME_OUT_INT_ENA LP_I2C_TRANS_COMPLETE_INT_ENA LP_I2C_MST_TXFIFO_UDF_INT_ENA LP_I2C_ARBITRATION_LOST_INT_ENA LP_I2C_BYTE_TRANS_DONE_INT_ENA LP_I2C_END_DETECT_INT_ENA LP_I2C_RXFIFO_OVF_INT_ENA LP_I2C_TXFIFO_WM_INT_ENA LP_I2C_RXFIFO_WM_INT_ENA																	
31																16	15	14	13	12	11	10	9	8	7	6	5	4	3	2	1	0	Reset
0 0																																	

LP_I2C_RXFIFO_WM_INT_ENA Write 1 to enable LP_I2C_RXFIFO_WM_INT interrupt. (R/W)

LP_I2C_TXFIFO_WM_INT_ENA Write 1 to enable LP_I2C_TXFIFO_WM_INT interrupt. (R/W)

LP_I2C_RXFIFO_OVF_INT_ENA Write 1 to enable LP_I2C_RXFIFO_OVF_INT interrupt. (R/W)

LP_I2C_END_DETECT_INT_ENA Write 1 to enable the LP_I2C_END_DETECT_INT interrupt. (R/W)

LP_I2C_BYTE_TRANS_DONE_INT_ENA Write 1 to enable the LP_I2C_END_DETECT_INT interrupt. (R/W)

LP_I2C_ARBITRATION_LOST_INT_ENA Write 1 to enable the LP_I2C_ARBITRATION_LOST_INT interrupt. (R/W)

LP_I2C_MST_TXFIFO_UDF_INT_ENA Write 1 to enable LP_I2C_TRANS_COMPLETE_INT interrupt. (R/W)

LP_I2C_TRANS_COMPLETE_INT_ENA Write 1 to enable the LP_I2C_TRANS_COMPLETE_INT interrupt. (R/W)

LP_I2C_TIME_OUT_INT_ENA Write 1 to enable the LP_I2C_TIME_OUT_INT interrupt. (R/W)

LP_I2C_TRANS_START_INT_ENA Write 1 to enable the LP_I2C_TRANS_START_INT interrupt. (R/W)

LP_I2C_NACK_INT_ENA Write 1 to enable LP_I2C_SLAVE_STRETCH_INT interrupt. (R/W)

LP_I2C_TXFIFO_OVF_INT_ENA Write 1 to enable LP_I2C_TXFIFO_OVF_INT interrupt. (R/W)

LP_I2C_RXFIFO_UDF_INT_ENA Write 1 to enable LP_I2C_RXFIFO_UDF_INT interrupt. (R/W)

LP_I2C_SCL_ST_TO_INT_ENA Write 1 to enable LP_I2C_SCL_ST_TO_INT interrupt. (R/W)

LP_I2C_SCL_MAIN_ST_TO_INT_ENA Write 1 to enable LP_I2C_SCL_MAIN_ST_TO_INT interrupt. (R/W)

LP_I2C_DET_START_INT_ENA Write 1 to enable LP_I2C_DET_START_INT interrupt. (R/W)

Register 28.57. LP_I2C_INT_STATUS_REG (0x002C)

Continued from the previous page...

LP_I2C_NACK_INT_ST The masked interrupt status status of LP_I2C_SLAVE_STRETCH_INT interrupt. (RO)

LP_I2C_TXFIFO_OVF_INT_ST The masked interrupt status status of LP_I2C_TXFIFO_OVF_INT interrupt. (RO)

LP_I2C_RXFIFO_UDF_INT_ST The masked interrupt status status of LP_I2C_RXFIFO_UDF_INT interrupt. (RO)

LP_I2C_SCL_ST_TO_INT_ST The masked interrupt status status of LP_I2C_SCL_ST_TO_INT interrupt. (RO)

LP_I2C_SCL_MAIN_ST_TO_INT_ST The masked interrupt status status of LP_I2C_SCL_MAIN_ST_TO_INT interrupt. (RO)

LP_I2C_DET_START_INT_ST The masked interrupt status status of LP_I2C_DET_START_INT interrupt. (RO)

Register 28.58. LP_I2C_COMD0_REG (0x0058)

<i>LP_I2C_COMMAND0_DONE</i>														<i>(reserved)</i>														<i>LP_I2C_COMMAND0</i>													
31														14	13													0													
0														0													0	Reset													

LP_I2C_COMMAND0 Configures command 0.

It consists of three parts:

op_code is the command

0: RSTART

1: WRITE

2: READ

3: STOP

4: END.

Byte_num represents the number of bytes that need to be sent or received.

ack_check_en, ack_exp and ack are used to control the ACK bit. See I2C cmd structure [28-6](#) for more information. (R/W)

LP_I2C_COMMAND0_DONE Represents whether command 0 is done in I2C Master mode.

0: Not done

1: Done

(R/W/SS)

Register 28.59. LP_I2C_COMD1_REG (0x005C)

<i>LP_I2C_COMMAND1_DONE</i>														<i>(reserved)</i>														<i>LP_I2C_COMMAND1</i>													
31														14	13													0													
0														0													0	Reset													

LP_I2C_COMMAND1 Configures command 1.

See details in I2C_CMD0_REG[13:0]. (R/W)

LP_I2C_COMMAND1_DONE Represents whether command 1 is done in I2C Master mode.

0: Not done

1: Done

(R/W/SS)

Register 28.64. LP_I2C_COMD6_REG (0x0070)

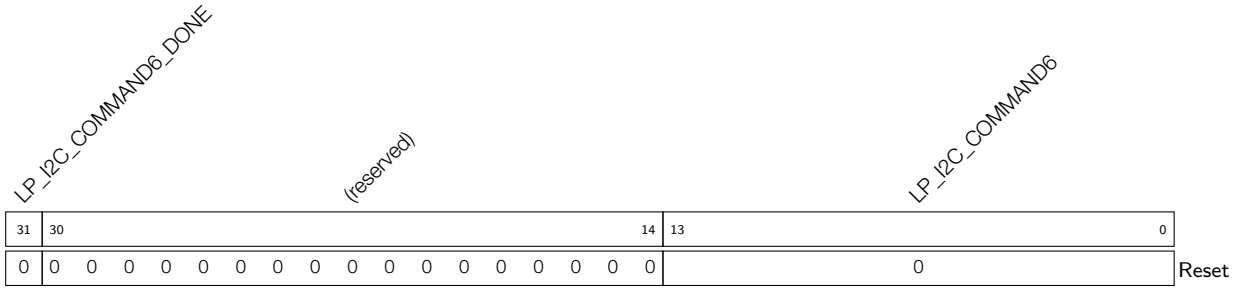

LP_I2C_COMMAND6 Configures command 6. See details in I2C_CMD0_REG[13:0]. (R/W)

LP_I2C_COMMAND6_DONE Represents whether command 6 is done in I2C Master mode.

0: Not done

1: Done

(R/W/SS)

Register 28.65. LP_I2C_COMD7_REG (0x0074)

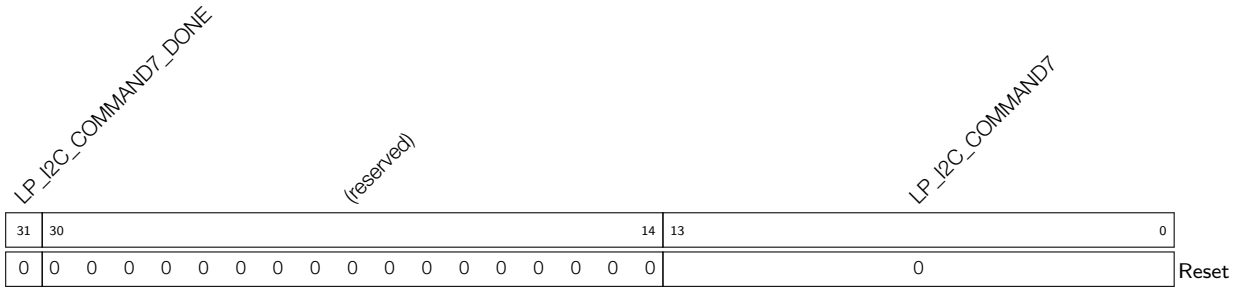

LP_I2C_COMMAND7 Configures command 7. See details in I2C_CMD0_REG[13:0]. (R/W)

LP_I2C_COMMAND7_DONE Represents whether command 7 is done in I2C Master mode.

0: Not done

1: Done

(R/W/SS)

Register 28.66. LP_I2C_DATE_REG (0x00F8)

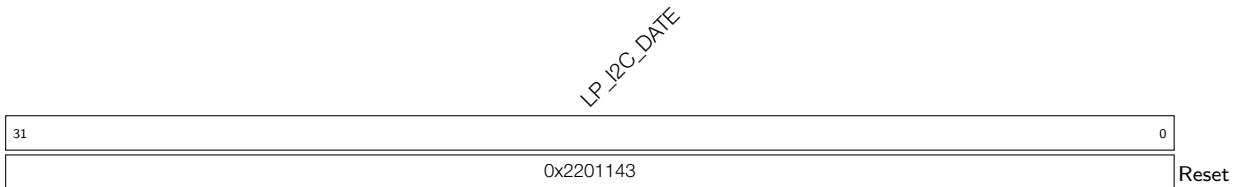

LP_I2C_DATE Version control register. (R/W)

Register 28.67. LP_I2C_TXFIFO_START_ADDR_REG (0x0100)

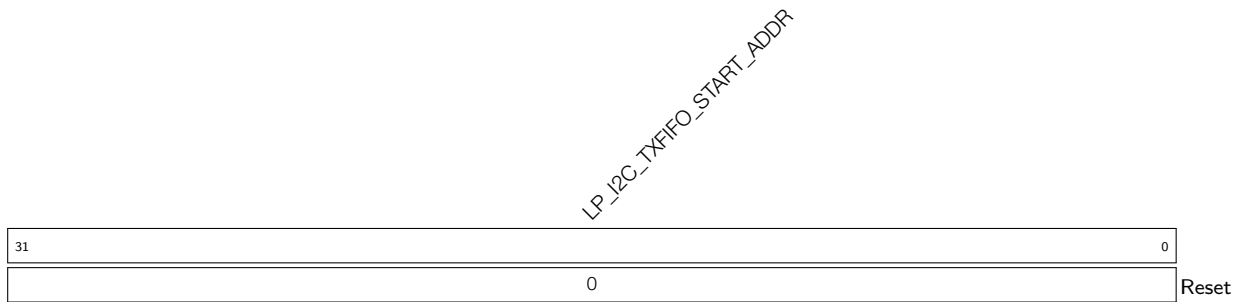

LP_I2C_TXFIFO_START_ADDR Represents the I2C txfifo first address. (HRO)

Register 28.68. LP_I2C_RXFIFO_START_ADDR_REG (0x0180)

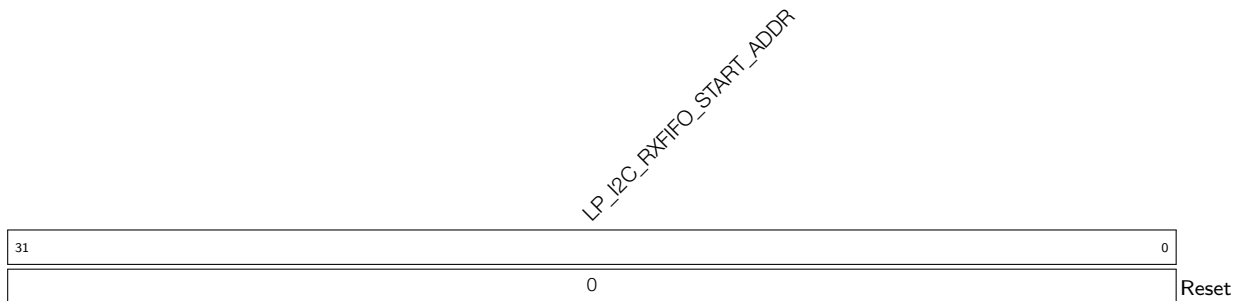

LP_I2C_RXFIFO_START_ADDR Represents the I2C rxfifo first address. (HRO)

29 I2S Controller (I2S)

29.1 Overview

ESP32-C6 has a built-in I2S interface, which provides a flexible communication interface for streaming digital data in multimedia applications, especially digital audio applications.

The I2S standard bus defines three signals: a bit clock signal (BCK), a channel/word select signal (WS), and a serial data signal (SD). A basic I2S data bus has one master and one slave. The roles remain unchanged throughout the communication. The I2S module on ESP32-C6 provides separate transmit (TX) and receive (RX) units for high performance.

29.2 Terminology

To better illustrate the functionality of I2S, the following terms are used in this chapter.

Master mode	As a master, I2S drives BCK/WS signals, and sends data to or receives data from a slave.
Slave mode	As a slave, I2S is driven by BCK/WS signals, and receives data from or sends data to a master.
Full-duplex	There are two separate data lines. Transmitted and received data are carried simultaneously.
Half-duplex	Only one side, the master or the slave, sends data first, and the other side receives data. Sending data and receiving data can not happen at the same time.
A-law and μ-law	A-law and μ -law are compression/decompression algorithms in digital pulse code modulated (PCM) non-uniform quantization, which can effectively improve the signal-to-quantization noise ratio.
TDM RX mode	In this mode, pulse code modulated (PCM) data is received and stored into memory via direct memory access (DMA), utilizing time division multiplexing (TDM). The signal lines include: BCK, WS, and SD. Data from 16 channels at most can be received. TDM Philips standard, TDM MSB alignment standard, and TDM PCM standard are supported in this mode, depending on user configuration.
Normal PDM RX mode	In this mode, pulse density modulation (PDM) data is received and stored into memory via DMA. Used signals: WS and DATA. PDM standard is supported in this mode by user configuration.
TDM TX mode	In this mode, pulse code modulated (PCM) data is sent from memory via DMA, in a way of time division multiplexing (TDM). The signal lines include: BCK, WS, and DATA. Data up to 16 channels can be sent. TDM Philips standard, TDM MSB alignment standard, and TDM PCM standard are supported in this mode, depending on user configuration.
Normal PDM TX mode	In this mode, pulse density modulation (PDM) data is sent from memory via DMA. The signal lines include: WS and DATA. PDM standard is supported in this mode by user configuration.

PCM-to-PDM TX mode In this mode, I2S as a **master**, converts the pulse code modulated (PCM) data from memory via DMA into pulse density modulation (PDM) data, and then sends the data out. Used signals: WS and DATA. PDM standard is supported in this mode by user configuration.

29.3 Features

The I2S module has the following features:

- Master mode and slave mode
- Full-duplex and half-duplex communications
- Separate TX and RX units that can work independently or simultaneously
- A variety of audio standards supported:
 - TDM Philips standard
 - TDM MSB alignment standard
 - TDM PCM standard
 - PDM standard
- Configurable high-precision sample clock:
 - Supports the following frequencies: 8 kHz, 16 kHz, 32 kHz, 44.1 kHz, 48 kHz, 88.2 kHz, 96 kHz, 128 kHz, and 192 kHz (Note that in slave mode, due to the frequency limitation of the clock source, the maximum sampling frequency is limited by the data bit width and number of channels. For detailed information, refer to [Section 29.6](#))
- 8-/16-/24-/32-bit data communication
- Direct Memory Access (DMA)
- Standard I2S interface interrupts

29.4 System Architecture

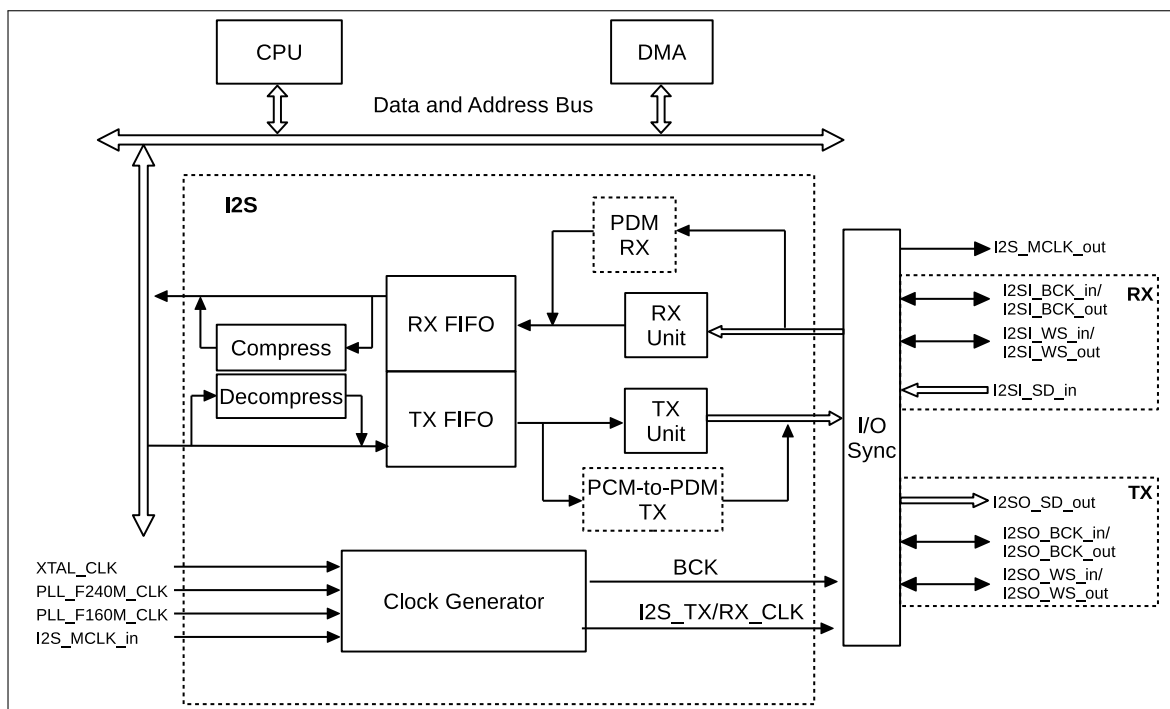

Figure 29-1. ESP32-C6 I2S System Diagram

Figure 29-1 shows the structure of ESP32-C6 I2S module, consisting of:

- Transmit control unit (TX Unit)
- Receive control unit (RX Unit)
- Input and output timing unit (I/O Sync)
- Clock divider (Clock Generator)
- 64 x 32-bit TX FIFO
- 64 x 32-bit RX FIFO
- Compress/Decompress units

I2S module supports direct memory access (DMA) to internal memory. For more information, see Chapter 4 [GDMA Controller \(GDMA\)](#).

Both the TX unit and the RX unit have a three-line interface that uses a bit clock line (BCK), a word select line (WS), and a serial data line (SD). The SD line of the TX unit is fixed as output, and the SD line of the RX unit as input. BCK and WS signal lines for TX unit and RX unit can be configured as master output mode or slave input mode.

The signal bus of I2S module is shown at the right part of Figure 29-1. The naming of these signals in RX and TX units follows the pattern: I2SA_B_C, such as I2SI_BCK_in.

- “A” represents the direction of data bus, which includes:
 - “I”: input, receiving

- “O”: output, transmitting
- “B” represents the signal function, which includes:
 - BCK
 - WS
 - SD
- “C” represents the signal direction, which includes:
 - “in”: input signal into I2S module
 - “out”: output signal from I2S module

Table 29-2 provides a detailed description of I2S signals.

Table 29-2. I2S Signal Description

Signal	Direction	Function
I2SI_BCK_in	Input	In I2S slave mode, inputs BCK signal for RX unit.
I2SI_BCK_out	Output	In I2S master mode, outputs BCK signal for RX unit.
I2SI_WS_in	Input	In I2S slave mode, inputs WS signal for RX unit.
I2SI_WS_out	Output	In I2S master mode, outputs WS signal for RX unit.
I2SI_Data_in	Input	Works as the serial input data bus for I2S RX unit.
I2SO_Data_out	Output	Works as the serial output data bus for I2S TX unit.
I2SO_BCK_in	Input	In I2S slave mode, inputs BCK signal for TX unit.
I2SO_BCK_out	Output	In I2S master mode, outputs BCK signal for TX unit.
I2SO_WS_in	Input	In I2S slave mode, inputs WS signal for TX unit.
I2SO_WS_out	Output	In I2S master mode, outputs WS signal for TX unit.
I2S_MCLK_in	Input	In I2S slave mode, works as a clock source from the external master.
I2S_MCLK_out	Output	In I2S master mode, works as a clock source for the external slave.

Note:

Any required signals of I2S must be mapped to the chip's pins via GPIO matrix. For more information, see Chapter 7 *IO MUX and GPIO Matrix (GPIO, IO MUX)*.

29.5 Supported Audio Standards

ESP32-C6 I2S supports multiple audio standards, including TDM Philips standard, TDM MSB alignment standard, TDM PCM standard, and PDM standard.

Select the needed standard by configuring the following bits:

- [I2S_TX/RX_TDM_EN](#)
 - 0: disable TDM mode.
 - 1: enable TDM mode.
- [I2S_TX/RX_PDM_EN](#)
 - 0: disable PDM mode.

- 1: enable PDM mode.
- [I2S_TX/RX_MSB_SHIFT](#)
 - 0: WS and SD signals change simultaneously, i.e., enable MSB alignment standard.
 - 1: WS signal changes one BCK clock cycle earlier than SD signal, i.e., enable Philips standard or select PCM standard.
- [I2S_TX/RX_PCM_BYPASS](#)
 - 0: enable PCM standard.
 - 1: disable PCM standard.

29.5.1 TDM Philips Standard

Philips specifications require that WS signal changes one BCK clock cycle earlier than SD signal on BCK falling edge, which means that WS signal is valid from one clock cycle before transmitting the first bit of channel data and changes one clock before the end of channel data transfer. SD signal line transmits the most significant bit of audio data first.

Compared with Philips standard, TDM Philips standard supports multiple channels. See Figure 29-2.

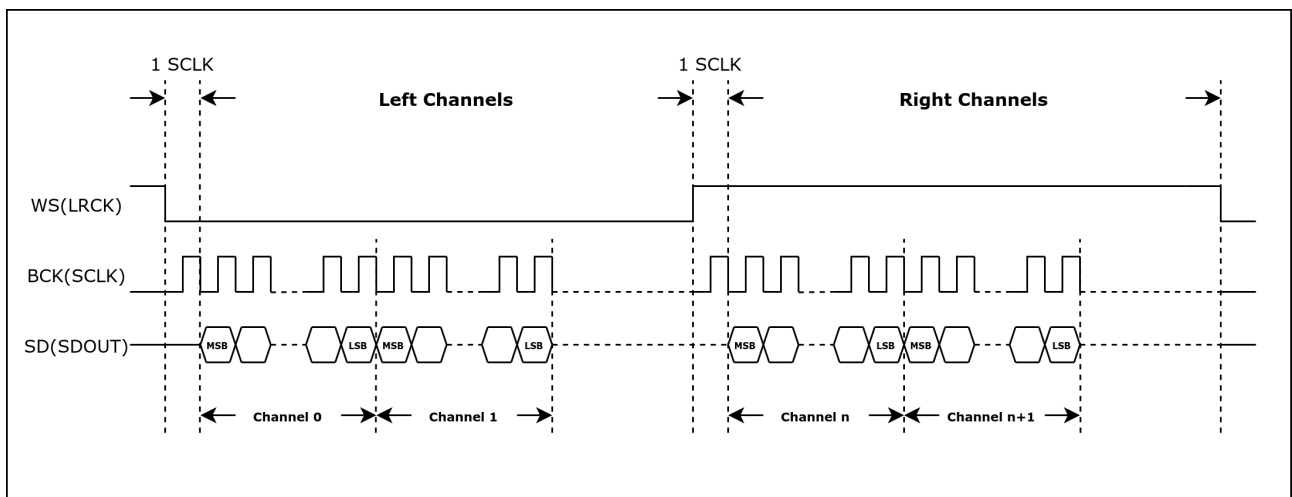

Figure 29-2. TDM Philips Standard Timing Diagram

29.5.2 TDM MSB Alignment Standard

MSB alignment specifications require that WS and SD signals change simultaneously on the falling edge of BCK. The WS signal is valid until the end of channel data transfer. The SD signal line transmits the most significant bit of audio data first.

Compared with MSB alignment standard, TDM MSB alignment standard supports multiple channels. See Figure 29-3.

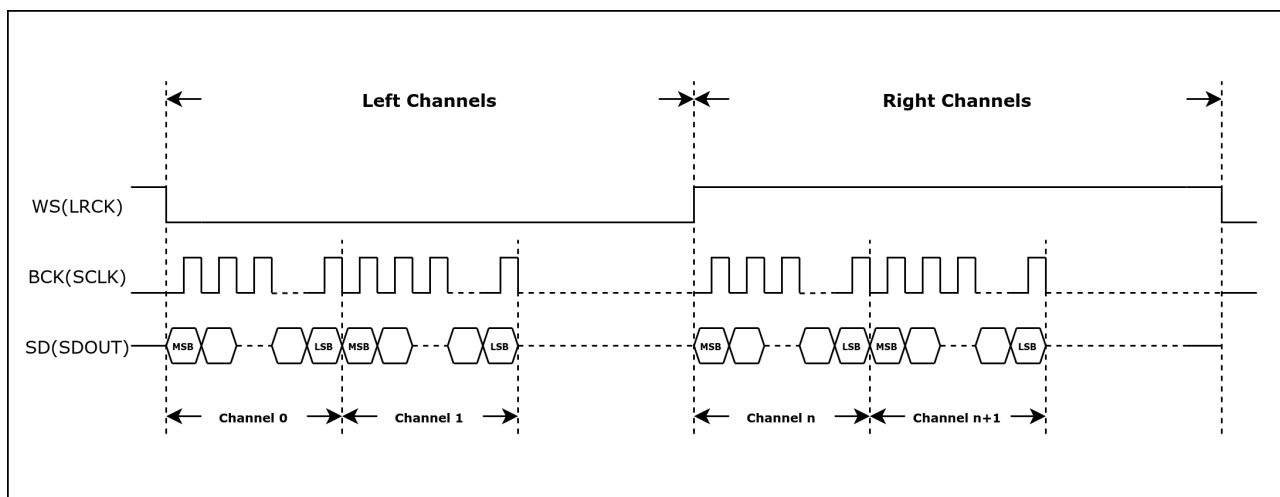

Figure 29-3. TDM MSB Alignment Standard Timing Diagram

29.5.3 TDM PCM Standard

Short frame synchronization under PCM standard requires that WS signal changes one BCK clock cycle earlier than SD signal on the falling edge of BCK, which means that the WS signal becomes valid one clock cycle before transferring the first bit of channel data and remains unchanged in this BCK clock cycle. SD signal line transmits the most significant bit of audio data first.

Compared with PCM standard, TDM PCM standard supports multiple channels. See Figure 29-4.

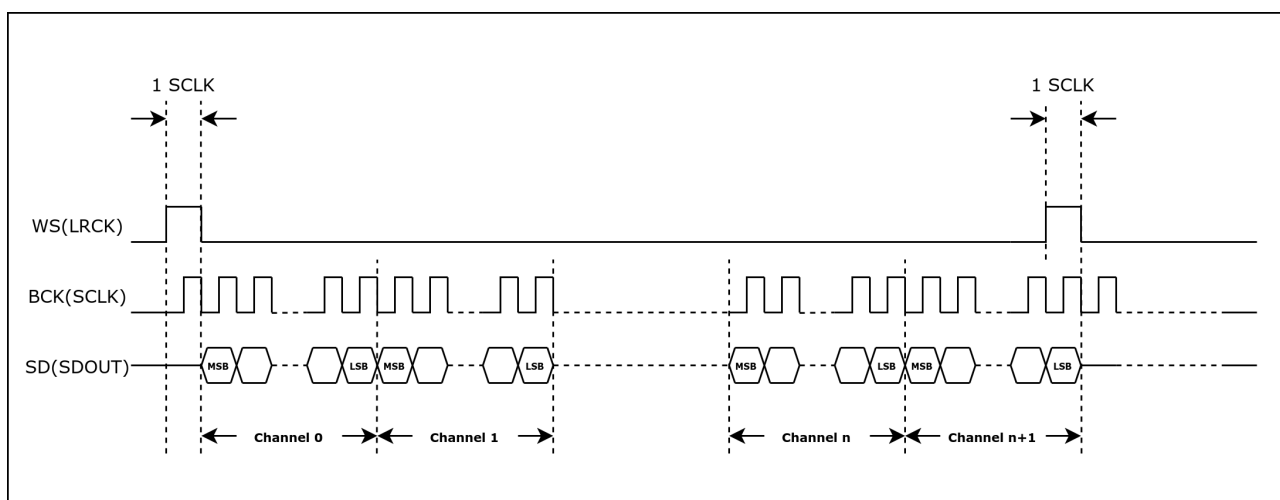

Figure 29-4. TDM PCM Standard Timing Diagram

29.5.4 PDM Standard

Under PDM standard, WS signal changes continuously during data transmission. The low-level and high-level of this signal indicates the left channel and right channel respectively. WS and SD signals change simultaneously on the falling edge of BCK. See Figure 29-5.

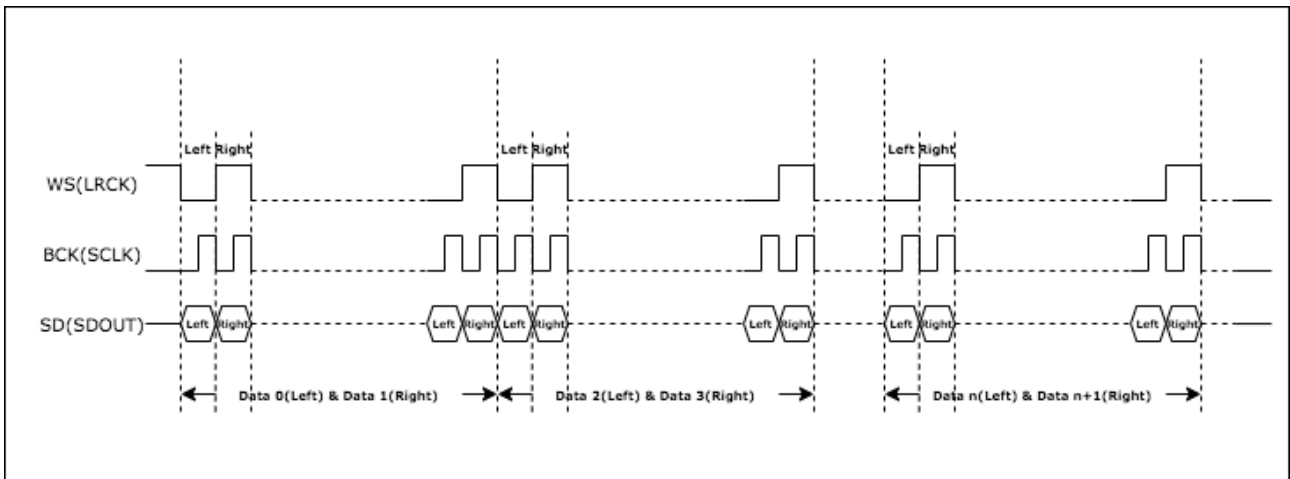

Figure 29-5. PDM Standard Timing Diagram

29.6 I2S TX/RX Clock

I2S_TX/RX_CLK is the master clock of I2S TX/RX unit, divided from:

- 40 MHz XTAL_CLK
- 160 MHz PLL_F160M_CLK
- 240 MHz PLL_F240M_CLK
- or external input clock: I2S_MCLK_in

The serial clock (BCK) of the I2S TX/RX unit is divided from I2S_TX/RX_CLK, as shown in Figure 29-6.

PCR_I2S_TX/RX_CLKM_SEL is used to select clock source for TX/RX unit, and PCR_I2S_TX/RX_CLKM_EN to enable or disable the clock source.

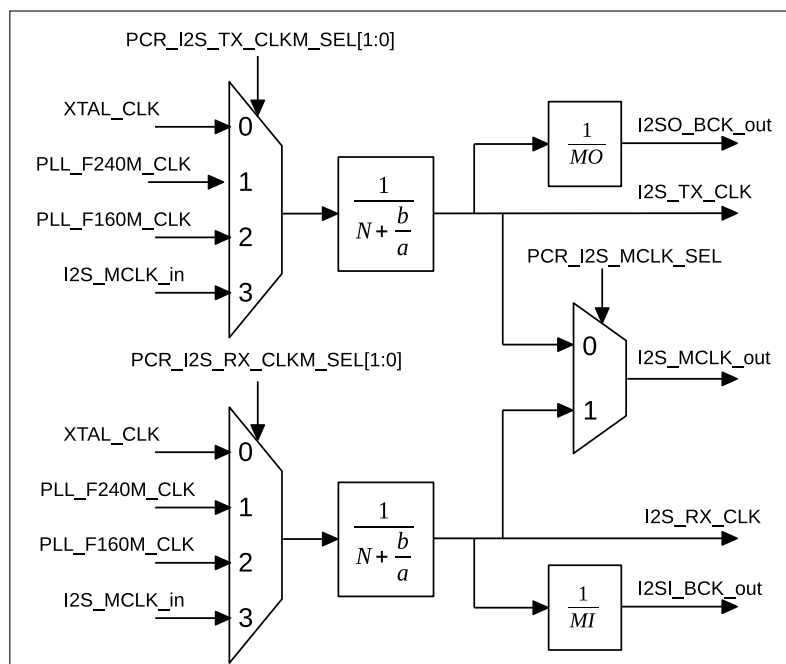

Figure 29-6. I2S Clock Generator

The following formula shows the relation between I2S_TX/RX_CLK frequency f_{I2S_TX/RX_CLK} and the divider clock source frequency $f_{I2S_CLK_S}$:

$$f_{I2S_TX/RX_CLK} = \frac{f_{I2S_CLK_S}}{N + \frac{b}{a}}$$

N is an integer value between 2 and 256. The value of N corresponds to the value of `PCR_I2S_TX/RX_CLKM_DIV_NUM` in register `PCR_I2S_TX/RX_CLKM_CONF_REG` as follows:

- When `PCR_I2S_TX/RX_CLKM_DIV_NUM` = 0, N = 256;
- When `PCR_I2S_TX/RX_CLKM_DIV_NUM` = 1, N = 2;
- When `PCR_I2S_TX/RX_CLKM_DIV_NUM` has any other value, N = `PCR_I2S_TX/RX_CLKM_DIV_NUM`.

The values of “a” and “b” in fractional divider depend only on x, y, z, and yn1. The corresponding formulas are as follows:

- When $b \leq \frac{a}{2}$, $yn1 = 0$, $x = \text{floor}(\lceil \frac{a}{b} \rceil) - 1$, $y = a \% b$, $z = b$;
- When $b > \frac{a}{2}$, $yn1 = 1$, $x = \text{floor}(\lceil \frac{a}{a-b} \rceil) - 1$, $y = a \% (a - b)$, $z = a - b$.

The values of x, y, z, and yn1 are configured in `PCR_I2S_TX/RX_CLKM_DIV_X`, `PCR_I2S_TX/RX_CLKM_DIV_Y`, `PCR_I2S_TX/RX_CLKM_DIV_Z`, and `PCR_I2S_TX/RXCLKM_DIV_YN1`.

To configure the integer divider, clear `PCR_I2S_TX/RX_CLKM_DIV_X` and `PCR_I2S_TX/RX_CLKM_DIV_Z`, then set `PCR_I2S_TX/RX_CLKM_DIV_Y` to 1.

Note:

Using fractional divider may introduce some clock jitter.

In master TX mode, the serial clock BCK for I2S TX unit is `I2SO_BCK_out` divided from `I2S_TX_CLK`, which is:

$$f_{I2SO_BCK_out} = \frac{f_{I2S_TX_CLK}}{MO}$$

“MO” is an integer value:

$$MO = I2S_TX_BCK_DIV_NUM + 1$$

Note:

Note that `I2S_TX_BCK_DIV_NUM` must not be configured as 1.

In master RX mode, the serial clock BCK for I2S RX unit is `I2SI_BCK_out` divided from `I2S_RX_CLK`, which is:

$$f_{I2SI_BCK_out} = \frac{f_{I2S_RX_CLK}}{MI}$$

“MI” is an integer value:

$$MI = I2S_RX_BCK_DIV_NUM + 1$$

Note:

- `I2S_RX_BCK_DIV_NUM` must not be configured as 1.
- In I2S slave mode, make sure $f_{I2S_TX/RX_CLK} \geq 8 * f_{BCK}$. The I2S module can output `I2S_MCLK_out` as the master clock for peripherals.

29.7 I2S Reset

The units and FIFOs in I2S module are reset by the following bits.

- I2S TX/RX units: reset by the bits `I2S_TX_RESET` and `I2S_RX_RESET`;
- I2S TX/RX FIFO: reset by the bits `I2S_TX_FIFO_RESET` and `I2S_RX_FIFO_RESET`.

Note:

The I2S module clock must be configured first before the module and FIFO are reset.

29.8 I2S Master/Slave Mode

The ESP32-C6 I2S module can operate as a master or a slave in half-duplex and full-duplex communications, depending on the configuration of `I2S_RX_SLAVE_MOD` and `I2S_TX_SLAVE_MOD`.

- `I2S_TX_SLAVE_MOD`
 - 0: master TX mode
 - 1: slave TX mode
- `I2S_RX_SLAVE_MOD`
 - 0: master RX mode
 - 1: slave RX mode

29.8.1 Master/Slave TX Mode

- I2S works as a master transmitter:
 - Set `I2S_TX_START` to start transmitting data.
 - TX unit keeps driving the clock signal and serial data.
 - If `I2S_TX_STOP_EN` is set and all the data in FIFO is transmitted, the master stops transmitting data and clock signals.
 - If `I2S_TX_STOP_EN` is cleared and all the data in FIFO is transmitted, meanwhile no new data is filled into FIFO, then the TX unit keeps sending the last data frame and clock signal.
 - Master stops sending data when the bit `I2S_TX_START` is cleared.
- I2S works as a slave transmitter:
 - Set `I2S_TX_START`.
 - Wait for the master BCK clock to enable a transmit operation.

- If [I2S_TX_STOP_EN](#) is set and all the data in FIFO is transmitted, then the slave keeps sending zeros, till the master stops providing BCK signal.
- If [I2S_TX_STOP_EN](#) is cleared and all the data in FIFO is transmitted, meanwhile no new data is filled into FIFO, then the TX unit keeps sending the last data frame.
- If [I2S_TX_START](#) is cleared, slave keeps sending zeros till the master stops providing BCK clock signal.

29.8.2 Master/Slave RX Mode

- I2S works as a master receiver:
 - Set [I2S_RX_START](#) to start receiving data.
 - RX unit keeps outputting clock signal and sampling input data.
 - RX unit stops receiving data when the bit [I2S_RX_START](#) is cleared.
- I2S works as a slave receiver:
 - Set [I2S_RX_START](#).
 - Wait for master BCK signal to start receiving data.
 - RX unit stops receiving data when the bit [I2S_RX_START](#) is cleared.

29.9 Transmitting Data

Note:

Updating the configuration described in this and subsequent sections requires to set [I2S_TX_UPDATE](#) accordingly to synchronize registers from APB clock domain to TX clock domain. For more detailed configuration, see Section [29.11.1](#).

In TX mode, I2S first reads data through DMA and sends these data out via output signals according to the configured data mode and channel mode.

29.9.1 Data Format Control

Data format is controlled in the following phases:

- Phase I: read data from memory and write it to TX FIFO;
- Phase II: read the data to send (TX data) from TX FIFO and convert the data according to the output data mode;
- Phase III: clock out the TX data serially.

29.9.1.1 Bit Width Control of Channel Valid Data

The bit width of valid data in each channel is determined by [I2S_TX_BITS_MOD](#) and [I2S_TX_24_FILL_EN](#). For details, see the table below.

Table 29-3. Bit Width of Channel Valid Data

Channel Valid Data Width	I2S_TX_BITS_MOD	I2S_TX_24_FILL_EN
32	31	x*
	23	1
24	23	0
16	15	x
8	7	x

* "x" represents that this value is ignored.

29.9.1.2 Endian Control of Channel Valid Data

When I2S reads data through DMA, the data endian under various data width is controlled by `I2S_TX_BIG_ENDIAN`. Table 29-4 shows how `I2S_TX_BIG_ENDIAN` controls the data reading with different channel valid data widths.

Table 29-4. Endian of Channel Valid Data

Channel Valid Data Width	Original Data	Endian of Processed Data	I2S_TX_BIG_ENDIAN
32	{B3, B2, B1, B0}	{B3, B2, B1, B0}	0
		{B0, B1, B2, B3}	1
24	{B2, B1, B0}	{B2, B1, B0}	0
		{B0, B1, B2}	1
16	{B1, B0}	{B1, B0}	0
		{B0, B1}	1
8	{B0}	{B0}	x

Note:

B0, B1, B2, B3 each represents an 8-bit data, and the symbol {} means that the bytes are combined together. For example, {B3, B2, B1, B0} represents a 32-bit number, wherein B0 represents bit 0-7, B1 represents bit 8-15, B2 represents bit 16-23, and B3 represents bit 24-31.

29.9.1.3 A-law/ μ -law Compression and Decompression

ESP32-C6 I2S compresses/decompresses the valid data into 32-bit by A-law or by μ -law. If the bit width of valid data is smaller than 32, zeros are filled to the extra high bits of the data to be compressed/decompressed by default.

Note:

Extra high bits here mean the bits[31: channel valid data width] of the data to be compressed/decompressed.

Configure `I2S_TX_PCM_BYPASS`:

- 0: do not compress or decompress the data
- 1: compress or decompress the data

Configure [I2S_TX_PCM_CONF](#):

- 0: decompress the data using A-law
- 1: compress the data using A-law
- 2: decompress the data using μ -law
- 3: compress the data using μ -law

At this point, the first phase of data format control is completed.

29.9.1.4 Bit Width Control of Channel TX Data

The TX data width in each channel is determined by [I2S_TX_TDM_CHAN_BITS](#).

- If TX data width in each channel is larger than the valid data width, zeros will be filled to these extra bits.
Configure [I2S_TX_LEFT_ALIGN](#):
 - 0: the valid data is at the lower bits of TX data. Zeros are filled into higher bits of TX data;
 - 1: the valid data is at the higher bits of TX data. Zeros are filled into lower bits of TX data.
- If the TX data width in each channel is smaller than the valid data width, only the lower bits of valid data are sent out, and the higher bits are discarded.

At this point, the second phase of data format control is completed.

29.9.1.5 Bit Order Control of Channel Data

The data bit order in each channel is controlled by [I2S_TX_BIT_ORDER](#):

- 0: data is sent out from high bits to low bits;
- 1: data is sent out from low bits to high bits.

At this point, the data format control is completed. Figure [29-7](#) shows the complete process of TX data format control.

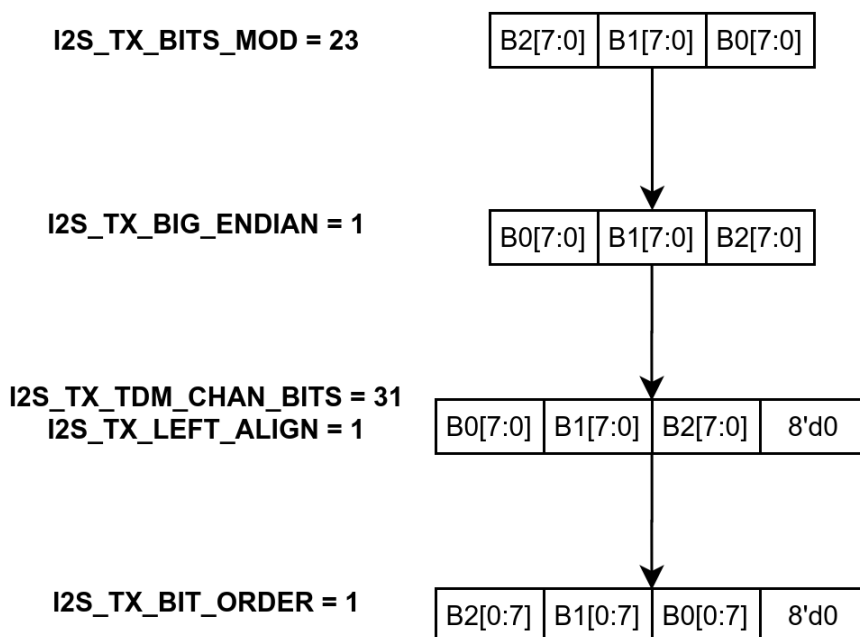

Figure 29-7. TX Data Format Control

29.9.2 Channel Mode Control

ESP32-C6 I2S supports both TDM TX mode and PDM TX mode. Set `I2S_TX_TDM_EN` to enable TDM TX mode, or set `I2S_TX_PDM_EN` to enable PDM TX mode.

Note:

- `I2S_TX_TDM_EN` and `I2S_TX_PDM_EN` must not be cleared or set simultaneously.
- Most stereo I2S codecs can be controlled by setting the I2S module into 2-channel mode under TDM standard.

29.9.2.1 I2S Channel Control in TDM TX Mode

In TDM TX mode, the total number of TX channels supported is related to the channel valid data width for I2S as follows:

Table 29-5. The Matching Between Valid Data Width and Number of TX Channel Supported

Channel Valid Data Width	Total Number of Channels Supported
32	4
24	5
16	8
8	16

The total number of TX channels in use is controlled by `I2S_TX_TDM_TOT_CHAN_NUM`. For example, if `I2S_TX_TDM_TOT_CHAN_NUM` is set to 5, six channels in total (channel 0 ~ 5) will be used to transmit data. See Figure 29-8.

In these TX channels, if `I2S_TX_TDM_CHANn_EN` is set to:

- 1: this channel sends the channel data out;
- 0: the TX data to be sent by this channel is controlled by `I2S_TX_CHAN_EQUAL`:
 - 1: the data of previous channel is sent out;
 - 0: the data stored in `I2S_SINGLE_DATA` is sent out.

In TDM TX master mode, WS signal is controlled by `I2S_TX_WS_IDLE_POL` and `I2S_TX_TDM_WS_WIDTH`:

- `I2S_TX_WS_IDLE_POL`: the default level of WS signal;
- `I2S_TX_TDM_WS_WIDTH`: the cycles the WS default level lasts for when transmitting all channel data.

`I2S_TX_HALF_SAMPLE_BITS` x 2 is equal to the BCK cycles in one WS period.

TDM Channel Configuration Example

In this example, register configuration is as follows:

- `I2S_TX_TDM_CHAN_NUM` = 5, i.e., channel 0 ~ 5 are used to transmit data.
- `I2S_TX_CHAN_EQUAL` = 1, i.e., that data of previous channel will be transmitted if the bit `I2S_TX_TDM_CHANn_EN` is cleared. $n = 0 \sim 5$.
- `I2S_TX_TDM_CHAN0/2/5_EN` = 1, i.e., these channels send their channel data out.
- `I2S_TX_TDM_CHAN1/3/4_EN` = 0, i.e., these channels send the previous channel data out.

Once the configuration is done, data is transmitted as follows.

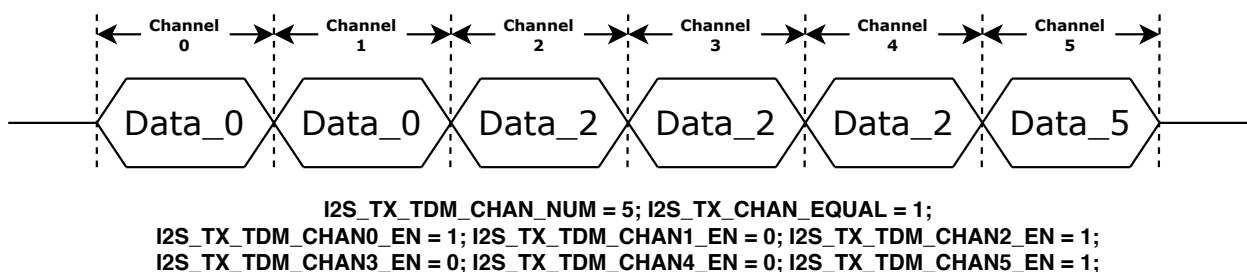

Figure 29-8. TDM Channel Control

29.9.2.2 I2S Channel Control in PDM TX Mode

ESP32-C6 I2S supports two PDM TX modes, namely, normal PDM TX mode and PCM-to-PDM TX mode.

In PDM TX mode, fetching data through DMA is controlled by `I2S_TX_MONO` and `I2S_TX_MONO_FST_VLD`.

See Table 29-6. Please configure the two bits according to the data stored in memory, be it the single-channel or dual-channel data.

Table 29-6. Data-Fetching Control in PDM Mode

Data-Fetching Control Option	Mode	I2S_TX_MONO	I2S_TX_MONO_FST_VLD
Post data-fetching request to DMA at any edge of WS signal	Stereo mode	0	x
Post data-fetching request to DMA only at the second half period of WS signal	Mono mode	1	0
Post data-fetching request to DMA only at the first half period of WS signal	Mono mode	1	1

When the I2S is in PDM TX master mode, the default level of WS signal is controlled by [I2S_TX_WS_IDLE_POL](#), and the WS signal frequency is half of the BCK signal frequency. The configuration of WS signal is similar to that of BCK signal. Please refer to Section 29.6 and Figure 29.6.

In **normal PDM TX mode**, I2S channel mode is controlled by [I2S_TX_CHAN_MOD](#) and [I2S_TX_WS_IDLE_POL](#). See the table below.

Table 29-7. I2S Channel Control in Normal PDM TX Mode

Channel Control Option	Left Channel	Right Channel	Mode Control Field ¹	Channel Select Bit ²
Stereo mode	Transmit the left channel data	Transmit the right channel data	0	x
Mono mode	Transmit the left channel data	Transmit the left channel data	1	0
	Transmit the right channel data	Transmit the right channel data	1	1
	Transmit the right channel data	Transmit the right channel data	2	0
	Transmit the left channel data	Transmit the left channel data	2	1
	Transmit the value of "single" ³	Transmit the right channel data	3	0
	Transmit the left channel data	Transmit the value of "single"	3	1
	Transmit the left channel data	Transmit the value of "single"	4	0
	Transmit the value of "single"	Transmit the right channel data	4	1

¹ [I2S_TX_CHAN_MOD](#)

² [I2S_TX_WS_IDLE_POL](#)

³ The "single" value is equal to the value of [I2S_SINGLE_DATA](#).

In **PCM-to-PDM TX mode**, the PCM data through DMA is converted to PDM data and then output in PDM signal format. Configure [I2S_PCM2PDM_CONV_EN](#) to enable this mode. The register configuration for PCM-to-PDM TX mode is as follows:

- Configure 1-line PDM output format or 1-/2-line DAC output mode as the table below:

Table 29-8. PCM-to-PDM TX Mode

Channel Output Format	I2S_TX_PDM_DAC_MODE_EN	I2S_TX_PDM_DAC_2OUT_EN
1-line PDM output format ¹	0	x
1-line DAC output format ²	1	0
2-line DAC output format	1	1

Note:

1. In PDM output format, SD data of two channels is sent out in one WS period.
2. In DAC output format, SD data of one channel is sent out in one WS period.

- Configure sampling frequency and upsampling rate:

In PCM-to-PDM TX mode, PDM clock frequency is equal to BCK frequency. The relation of sampling frequency (f_{Sampling}) and BCK frequency is as follows:

$$f_{\text{Sampling}} = \frac{f_{\text{BCK}}}{\text{OSR}}$$

Upsampling rate (OSR) is related to `I2S_TX_PDM_SINC_OSR2` as follows:

$$\text{OSR} = \text{I2S_TX_PDM_SINC_OSR2} \times 64$$

Sampling frequency f_{Sampling} is related to `I2S_TX_PDM_FS` as follows:

$$f_{\text{Sampling}} = \text{I2S_TX_PDM_FS} \times 100$$

Configure the registers according to needed sampling frequency, upsampling rate, and PDM clock frequency.

PDM Channel Configuration Example

In this example, the register configuration is as follows.

- `I2S_PCM2PDM_CONV_EN` = 0, i.e., the normal PDM TX mode is selected.
- `I2S_TX_MONO` = 0, i.e., data is fetched from memory via DMA in both the high and low levels of WS.
- `I2S_TX_CHAN_MOD` = 2, i.e., mono mode is selected, and the right channel data will be discarded.
- `I2S_TX_WS_IDLE_POL` = 1, i.e., both the left channel and right channel transmit the left channel data.

Once the configuration is done, assume that the data in memory **after data format control** is:

Left	Right	Left	Right	...	Left	Right
------	-------	------	-------	-----	------	-------

Note:

1. The data above refers to the processed data after data format control instead of the original data.
2. The “Left” and “Right” represent channel data, and their bit widths are channel valid data width. Please refer to Section 29.9.1

Then the channel data is transmitted after channel mode control as follows.

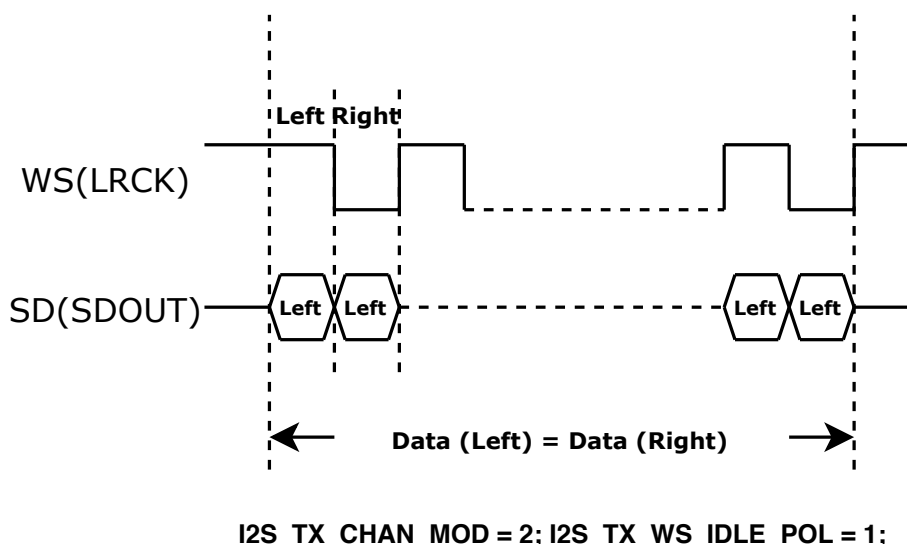

Figure 29-9. PDM Channel Control Example

29.10 Receiving Data

In RX mode, I2S first reads data from peripheral interface, and then stores the data into memory via DMA according to the configured channel mode and data mode.

29.10.1 Channel Mode Control

ESP32-C6 I2S supports both TDM RX mode and PDM RX mode. Set [I2S_RX_TDM_EN](#) to enable TDM RX mode, or set [I2S_RX_PDM_EN](#) to enable PDM RX mode.

Note:

[I2S_RX_TDM_EN](#) and [I2S_RX_PDM_EN](#) must not be cleared or set simultaneously.

29.10.1.1 I2S Channel Control in TDM RX Mode

In TDM RX mode, the total number of RX channels supported is related to the channel valid data width for I2S as follows:

Table 29-9. The Matching Between Valid Data Width and Number of RX Channel Supported

Channel Valid Data Width	Total Number of Channels Supported
32	4
24	5
16	8
8	16

In TDM RX mode, I2S supports up to 16 channels to input data. The total number of RX channels in use is controlled by [I2S_RX_TDM_TOT_CHAN_NUM](#). For example, if [I2S_RX_TDM_TOT_CHAN_NUM](#) is set to 5, channel 0 ~ 5 will be used to receive data.

In these RX channels, if `I2S_RX_TDM_CHANn_EN` is set to:

- 1: this channel data is valid and will be stored into RX FIFO;
- 0: this channel data is invalid and will not be stored into RX FIFO.

In TDM master mode, WS signal is controlled by `I2S_RX_WS_IDLE_POL` and `I2S_RX_TDM_WS_WIDTH`.

- `I2S_RX_WS_IDLE_POL`: the default level of WS signal;
- `I2S_RX_TDM_WS_WIDTH`: the cycles the WS default level lasts for when receiving all channel data.

`I2S_RX_HALF_SAMPLE_BITS` x 2 is equal to the BCK cycles in one WS period.

29.10.1.2 I2S Channel Control in PDM RX Mode

In PDM RX mode, I2S converts the serial data from channels to the data to be entered into memory.

In PDM RX master mode, the default level of WS signal is controlled by `I2S_RX_WS_IDLE_POL`. WS frequency is half of BCK frequency. The configuration of BCK signal is similar to that of WS signal as described in Section 29.6. Note, in PDM RX mode, the value of `I2S_RX_HALF_SAMPLE_BITS` must be same as that of `I2S_RX_BITS_MOD`.

29.10.2 Data Format Control

Data format is controlled in the following phases:

- Phase I: serial input data is converted into the data to be saved to RX FIFO;
- Phase II: the data is read from RX FIFO and converted according to the input data mode.

29.10.2.1 Bit Order Control of Channel Data

The data bit order in each channel is controlled by `I2S_RX_BIT_ORDER`:

- 0: serial data is entered from high bits to low bits;
- 1: serial data is entered from low bits to high bits.

At this point, the first phase of data format control is completed.

29.10.2.2 Bit Width Control of Channel Storage (Valid) Data

The storage data width in each channel is controlled by `I2S_RX_BITS_MOD` and `I2S_RX_24_FILL_EN`. See the table below.

Table 29-10. Channel Storage Data Width

Channel Storage Data Width	<code>I2S_RX_BITS_MOD</code>	<code>I2S_RX_24_FILL_EN</code>
32	31	x
	23	1
24	23	0
16	15	x
8	7	x

29.10.2.3 Bit Width Control of Channel RX Data

The RX data width in each channel is determined by [I2S_RX_TDM_CHAN_BITS](#).

- If the storage data width in each channel is smaller than the received (RX) data width, then only the bits within the storage data width is saved into memory. Configure [I2S_RX_LEFT_ALIGN](#) to:
 - 0: only the lower bits of the received data within the storage data width is stored to memory;
 - 1: only the higher bits of the received data within the storage data width is stored to memory.
- If the received data width is smaller than the storage data width in each channel, the higher bits of the received data will be filled with zeros and then the data is saved to memory.

29.10.2.4 Endian Control of Channel Storage Data

The received data is then converted into storage data (to be stored to memory) after some processing, such as discarding extra bits or filling zeros in missing bits. The endian of the storage data is controlled by [I2S_RX_BIG_ENDIAN](#) under various data width. See the table below.

Table 29-11. Channel Storage Data Endian

Channel Storage Data Width	Original Data	Endian of Processed Data	I2S_RX_BIG_ENDIAN
32	{B3, B2, B1, B0}	{B3, B2, B1, B0}	0
		{B0, B1, B2, B3}	1
24	{B2, B1, B0}	{B2, B1, B0}	0
		{B0, B1, B2}	1
16	{B1, B0}	{B1, B0}	0
		{B0, B1}	1
8	{B0}	{B0}	x

29.10.2.5 A-law/ μ -law Compression and Decompression

ESP32-C6 I2S compresses/decompresses the storage data in 32-bit by A-law or by μ -law. By default, zeros are filled into high bits.

Configure [I2S_RX_PCM_BYPASS](#):

- 0: do not compress or decompress the data
- 1: compress or decompress the data

Configure [I2S_RX_PCM_CONF](#):

- 0: decompress the data using A-law
- 1: compress the data using A-law
- 2: decompress the data using μ -law
- 3: compress the data using μ -law

At this point, the data format control is completed. Data then is stored into memory via DMA.

PRELIMINARY

29.11 Software Configuration Process

29.11.1 Configure I2S as TX Mode

Follow the steps below to configure I2S as TX mode via software:

1. Configure the clock as described in Section 29.6.
2. Configure signal pins according to Table 29-2.
3. Select the mode needed by configuring `I2S_TX_SLAVE_MOD`.
 - 0: master TX mode
 - 1: slave TX mode
4. Set needed TX data mode and TX channel mode as described in Section 29.9, and then set `I2S_TX_UPDATE`.
5. Reset TX unit and TX FIFO as described in Section 29.7.
6. Enable corresponding interrupts. See Section 29.12.
7. Configure DMA outlink.
8. Set `I2S_TX_STOP_EN` if needed. For more information, please refer to Section 29.8.1.
9. Start transmitting data:
 - In master mode, wait till I2S slave gets ready, then set `I2S_TX_START` to start transmitting data.
 - In slave mode, set `I2S_TX_START`. When the I2S master supplies BCK and WS signals, I2S slave starts transmitting data.
10. Wait for the interrupt signals set in Step 6, or check whether the transfer is completed by querying `I2S_TX_IDLE`:
 - 0: transmitter is working;
 - 1: transmitter is in idle state.
11. Clear `I2S_TX_START` to stop data transfer.

29.11.2 Configure I2S as RX Mode

Follow the steps below to configure I2S as RX mode via software:

1. Configure the clock as described in Section 29.6.
2. Configure signal pins according to Table 29-2.
3. Select the mode needed by configuring `I2S_RX_SLAVE_MOD`.
 - 0: master RX mode
 - 1: slave RX mode
4. Set needed RX data mode and RX channel mode as described in Section 29.10, and then set `I2S_RX_UPDATE`.
5. Reset RX unit and its FIFO according to Section 29.7.

6. Enable corresponding interrupts. See Section 29.12.
7. Configure DMA inlink, and set the length of RX data by configuring [I2S_RX_EOF_NUM_REG](#).
8. Start receiving data:
 - In master mode, when the slave is ready, set [I2S_RX_START](#) to start receiving data.
 - In slave mode, set [I2S_RX_START](#) to start receiving data when get BCK and WS signals from the master.
9. The received data is then stored to the specified address of ESP32-C6 memory according the configuration of DMA. Then the corresponding interrupt set in step 6 is generated.

29.12 I2S Interrupts

- [I2S_TX_HUNG_INT](#): triggered when transmitting data is timed out. For example, if module is configured as TX slave mode, but the master does not provide BCK or WS signal for a long time (specified in [I2S_LC_HUNG_CONF_REG](#)), then this interrupt will be triggered.
- [I2S_RX_HUNG_INT](#): triggered when receiving data is timed out. For example, if I2S module is configured as RX slave mode, but the master does not send data for a long time (specified in [I2S_LC_HUNG_CONF_REG](#)), then this interrupt will be triggered.
- [I2S_TX_DONE_INT](#): triggered when transmitting data is completed.
- [I2S_RX_DONE_INT](#): triggered when receiving data is completed.

29.12.1 Event Task Matrix Feature

ESP32-C6 I2S supports the Event Task Matrix (ETM) function, which allows I2S's ETM tasks to be triggered by any peripherals' ETM events, or I2S's ETM events to trigger any peripherals' ETM tasks. This section introduces the ETM tasks and events related to I2S. For more information, please refer to Chapter 11 [Event Task Matrix \(SOC_ETM\)](#).

I2S can receive the following ETM tasks:

- [I2S_TASK_START_TX](#): Enables I2S TX for data transfer.
- [I2S_TASK_START_RX](#): Enables I2S RX for data transfer.
- [I2S_TASK_STOP_TX](#): Stops I2S TX data transfer.
- [I2S_TASK_STOP_RX](#): Stops I2S RX data transfer.

I2S can generate the following ETM events:

- [I2S_EVT_TX_DONE](#): Indicates that I2S TX has completed data transmission.
- [I2S_EVT_RX_DONE](#): Indicates that I2S RX has completed data receiving.
- [I2S_EVT_X_WORDS_SENT](#): Indicates that the word number sent by I2S TX is equal to or larger than the value set by [I2S_ETM_TX_SEND_WORD_NUM](#).
- [I2S_EVT_X_WORDS_RECEIVED](#): Indicates that the word number received by I2S RX is equal to or larger than the value set by [I2S_ETM_RX_RECEIVE_WORD_NUM](#).

In practical applications, I2S's ETM events can trigger its own ETM tasks. For example, the I2S_EVT_X_WORDS_SENT event can trigger the I2S_TASK_STOP_TX task, and in this way stop the I2S operation through ETM.

29.13 Register Summary

The addresses in this section are relative to I2S Controller base address provided in Table 5-2 in Chapter 5 *System and Memory*.

The abbreviations given in Column **Access** are explained in Section *Access Types for Registers*.

Name	Description	Address	Access
Interrupt registers			
I2S_INT_RAW_REG	I2S interrupt raw register	0x000C	RO/WTC/SS
I2S_INT_ST_REG	I2S interrupt status register	0x0010	RO
I2S_INT_ENA_REG	I2S interrupt enable register	0x0014	R/W
I2S_INT_CLR_REG	I2S interrupt clear register	0x0018	WT
RX control and configuration registers			
I2S_RX_CONF_REG	I2S RX configuration register	0x0020	varies
I2S_RX_CONF1_REG	I2S RX configuration register 1	0x0028	R/W
I2S_TX_PCM2PDM_CONF_REG	I2S TX PCM-to-PDM configuration register	0x0040	R/W
I2S_TX_PCM2PDM_CONF1_REG	I2S TX PCM-to-PDM configuration register 1	0x0044	R/W
I2S_RX_TDM_CTRL_REG	I2S TX TDM mode control register	0x0050	R/W
I2S_RXEOF_NUM_REG	I2S RX data number control register	0x0064	R/W
TX control and configuration registers			
I2S_TX_CONF_REG	I2S TX configuration register	0x0024	varies
I2S_TX_CONF1_REG	I2S TX configuration register 1	0x002C	R/W
I2S_TX_TDM_CTRL_REG	I2S TX TDM mode control register	0x0054	R/W
RX timing register			
I2S_RX_TIMING_REG	I2S RX timing control register	0x0058	R/W
TX timing register			
I2S_TX_TIMING_REG	I2S TX timing control register	0x005C	R/W
Control and configuration registers			
I2S_LC_HUNG_CONF_REG	I2S timeout configuration register	0x0060	R/W
I2S_CONF_SIGLE_DATA_REG	I2S single data register	0x0068	R/W
TX status register			
I2S_STATE_REG	I2S TX status register	0x006C	RO
ETM register			
I2S_ETM_CONF_REG	I2S ETM configure register	0x0070	R/W
Version register			
I2S_DATE_REG	Version control register	0x0080	R/W

29.14 Registers

The addresses in this section are relative to I2S Controller base address provided in Table 5-2 in Chapter 5 *System and Memory*.

Register 29.1. I2S_INT_RAW_REG (0x000C)

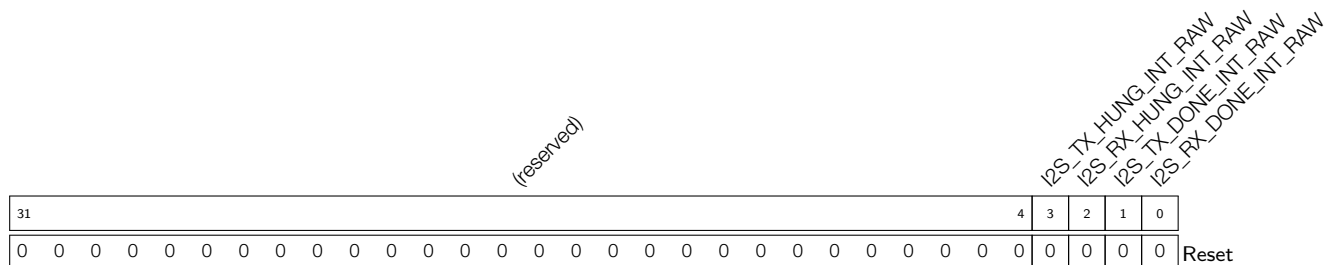

I2S_RX_DONE_INT_RAW The raw interrupt status of the **I2S_RX_DONE_INT** interrupt. (RO/WTC/SS)

I2S_TX_DONE_INT_RAW The raw interrupt status of the **I2S_TX_DONE_INT** interrupt. (RO/WTC/SS)

I2S_RX_HUNG_INT_RAW The raw interrupt status of the **I2S_RX_HUNG_INT** interrupt. (RO/WTC/SS)

I2S_TX_HUNG_INT_RAW The raw interrupt status of the **I2S_TX_HUNG_INT** interrupt. (RO/WTC/SS)

Register 29.2. I2S_INT_ST_REG (0x0010)

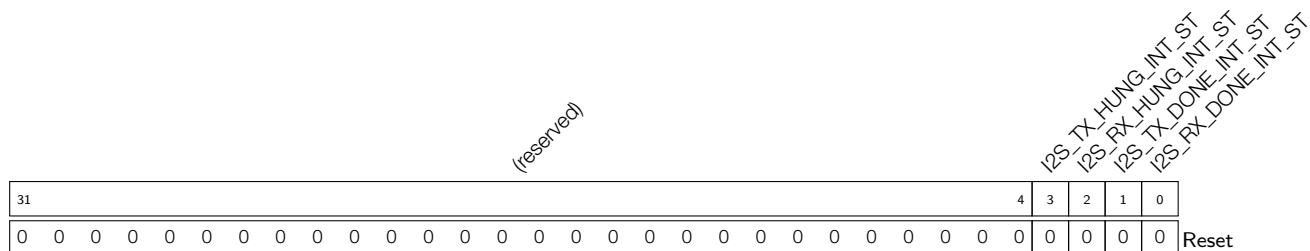

I2S_RX_DONE_INT_ST The masked interrupt status of the **I2S_RX_DONE_INT** interrupt. (RO)

I2S_TX_DONE_INT_ST The masked interrupt status of the **I2S_TX_DONE_INT** interrupt. (RO)

I2S_RX_HUNG_INT_ST The masked interrupt status of the **I2S_RX_HUNG_INT** interrupt. (RO)

I2S_TX_HUNG_INT_ST The masked interrupt status of the **I2S_TX_HUNG_INT** interrupt. (RO)

Register 29.3. I2S_INT_ENA_REG (0x0014)

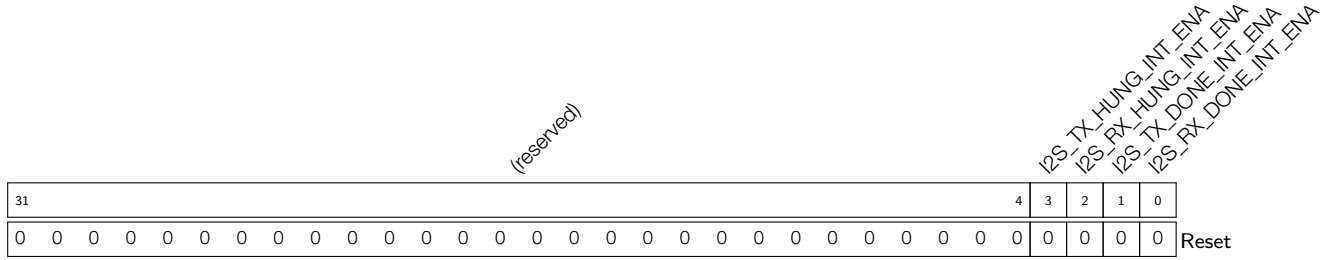

I2S_RX_DONE_INT_ENA Write 1 to enable the [I2S_RX_DONE_INT](#) interrupt. (R/W)

I2S_TX_DONE_INT_ENA Write 1 to enable the [I2S_TX_DONE_INT](#) interrupt. (R/W)

I2S_RX_HUNG_INT_ENA Write 1 to enable the [I2S_RX_HUNG_INT](#) interrupt. (R/W)

I2S_TX_HUNG_INT_ENA Write 1 to enable the [I2S_TX_HUNG_INT](#) interrupt. (R/W)

Register 29.4. I2S_INT_CLR_REG (0x0018)

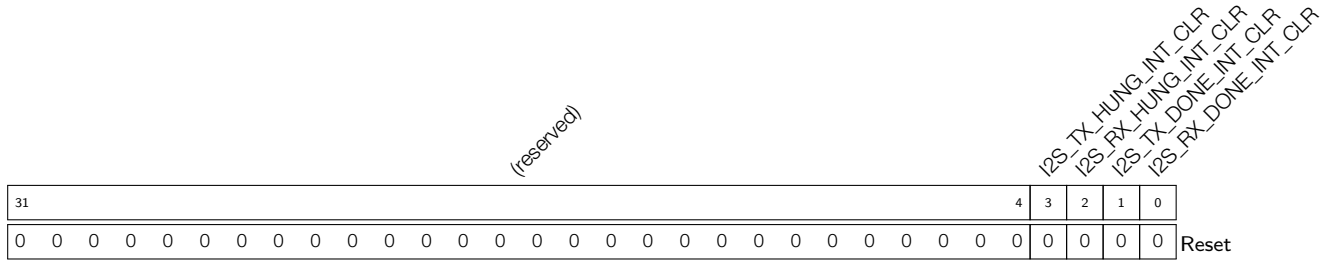

I2S_RX_DONE_INT_CLR Write 1 to clear the [I2S_RX_DONE_INT](#) interrupt. (WT)

I2S_TX_DONE_INT_CLR Write 1 to clear the [I2S_TX_DONE_INT](#) interrupt. (WT)

I2S_RX_HUNG_INT_CLR Write 1 to clear the [I2S_RX_HUNG_INT](#) interrupt. (WT)

I2S_TX_HUNG_INT_CLR Write 1 to clear the [I2S_TX_HUNG_INT](#) interrupt. (WT)

Register 29.5. I2S_RX_CONF_REG (0x0020)

(reserved)	31	21	20	19	18	17	16	15	14	13	12	11	10	9	8	7	6	5	4	3	2	1	0	Reset	
	0	0	0	0	0	0	0	0	1	0	1	0x1	1	0	0	0	0	0	0	0	0	0	0	0	

I2S_RX_RESET Configures whether to reset RX unit.

0: No effect

1: Reset

(WT)

I2S_RX_FIFO_RESET Configures whether to reset RX FIFO.

0: No effect

1: Reset

(WT)

I2S_RX_START Configures whether to start receiving data.

0: No effect

1: Start

(R/W/SC)

I2S_RX_SLAVE_MOD Configures whether to enable slave RX mode.

0: Disable

1: Enable

(R/W)

I2S_RX_MONO Configures whether to enable RX unit in mono mode.

0: Disable

1: Enable

(R/W)

I2S_RX_BIG_ENDIAN Configures I2S RX byte endian.

0: Low address data is saved to low address

1: Low address data is saved to high address

(R/W)

I2S_RX_UPDATE Configures whether to update I2S RX registers from APB clock domain to I2S RX clock domain.

0: No effect

1: Update

This bit will be cleared by hardware after the register update is done.

(R/W/SC)

Continued on the next page...

Register 29.5. I2S_RX_CONF_REG (0x0020)

Continued from the previous page...

I2S_RX_MONO_FST_VLD Configures the valid data channel in I2S RX mono mode.

0: The second channel data valid

1: The first channel data valid

(R/W)

I2S_RX_PCM_CONF Configures I2S RX compress/decompress mode.

0 (atol): A-law decompress

1 (ltoa): A-law compress

2 (utol): μ -law decompress

3 (ltou): μ -law compress

(R/W)

I2S_RX_PCM_BYPASS Configures whether to bypass the Compress/Decompress units for received data.

0: No effect

1: Bypass

(R/W)

I2S_RX_STOP_MODE Configures I2S RX stop mode.

0: I2S RX only stops when REG_TXRX_START is cleared

1: I2S RX stops when REG_TXRX_START is 0 or in_suc_eof is 1

2: I2S RX stops when REG_TXRX_START is 0 or RX FIFO is full

(R/W)

I2S_RX_LEFT_ALIGN Configures I2S RX alignment mode.

0: Right alignment mode

1: Left alignment mode

(R/W)

I2S_RX_24_FILL_EN Configures the bit number that the 24-bit channel data is stored to.

0: Store 24-bit channel data to 24 bits

1: Store 24-bit channel data to 32 bits (Extra bits are filled with zeros)

(R/W)

I2S_RX_WS_IDLE_POL Configures the relationship between WS level and which channel data to receive.

0: WS remains low when receiving left channel data and high when receiving right channel data

1: WS remains high when receiving left channel data and low when receiving right channel data

(R/W)

Continued on the next page...

Register 29.5. I2S_RX_CONF_REG (0x0020)

Continued from the previous page...

I2S_RX_BIT_ORDER Configures I2S RX bit order.

0: The highest bit is received first

1: The lowest bit is received first

(R/W)

I2S_RX_TDM_EN Configures whether to enable I2S TDM RX mode.

0: Disable

1: Enable

(R/W)

I2S_RX_PDM_EN Configures whether to enable I2S PDM RX mode.

0: Disable

1: Enable

(R/W)

Register 29.6. I2S_RX_CONF1_REG (0x0028)

(reserved)		I2S_RX_MSB_SHIFT		I2S_RX_TDM_CHAN_BITS		I2S_RX_HALF_SAMPLE_BITS		I2S_RX_BITS_MOD		I2S_RX_BCK_DIV_NUM		I2S_RX_TDM_WS_WIDTH	
31	30	29	28	24	23	18	17	13	12	7	6		0
0	0	1	0xf		0xf		0xf		6		0x0		Reset

I2S_RX_TDM_WS_WIDTH Configures the width of rx_ws_out (WS default level) in TDM mode. Width of rx_ws_out (WS default level) in TDM mode = $(I2S_RX_TDM_WS_WIDTH[6:0] + 1) \times T_BCK$. (R/W)

I2S_RX_BCK_DIV_NUM Configures the divider of BCK in RX mode. Note this divider must not be configured to 1. (R/W)

I2S_RX_BITS_MOD Configures the valid data bit length of I2S RX channel.

- 7: All the valid channel data is in 8-bit mode
 - 15: All the valid channel data is in 16-bit mode
 - 23: All the valid channel data is in 24-bit mode
 - 31: All the valid channel data is in 32-bit mode
 - Other values are invalid.
- (R/W)

I2S_RX_HALF_SAMPLE_BITS Configures I2S RX sample bits. BCK cycles in one WS period = $I2S_RX_HALF_SAMPLE_BITS \times 2$. (R/W)

I2S_RX_TDM_CHAN_BITS Configures RX bit number for each channel in TDM mode. Bit number expected = $I2S_RX_TDM_CHAN_BITS + 1$. (R/W)

I2S_RX_MSB_SHIFT Configures the timing between WS signal and the MSB of data.

- 0: Align at rising edge
 - 1: WS signal changes one BCK clock earlier
- (R/W)

Register 29.7. I2S_TX_PCM2PDM_CONF_REG (0x0040)

(reserved)							I2S_PCM2PDM_CONV_EN				I2S_TX_PDM_DAC_MODE_EN				I2S_TX_PDM_DAC_2OUT_EN				(reserved)				I2S_TX_PDM_SINC_OSR2				(reserved)			
31	26	25	24	23	22	21	20	19	18	17	16	15	14	13	12					5	4			1	0					
0	0	0	0	0	0	0	0	0	0	1	0	0x1	0x1	0x1	0x1	0x0						0x2			0					

Reset

I2S_TX_PDM_SINC_OSR2 Configures I2S TX PDM OSR value. (R/W)

I2S_TX_PDM_DAC_2OUT_EN Configures DAC output mode.

- 0: Enable 1-line DAC output mode
 - 1: Enable 2-line DAC output mode
- Only valid when I2S_TX_PDM_DAC_MODE_EN is set.
(R/W)

I2S_TX_PDM_DAC_MODE_EN Configures whether to enable 1-line PDM output mode or DAC output mode.

- 0: Enable 1-line PDM output mode
 - 1: Enable DAC output mode
- (R/W)

I2S_PCM2PDM_CONV_EN Configures whether to enable I2S TX PCM-to-PDM conversion.

- 0: Disable
 - 1: Enable
- (R/W)

Register 29.8. I2S_TX_PCM2PDM_CONF1_REG (0x0044)

(reserved)							(reserved)				(reserved)				I2S_TX_PDM_FS				(reserved)			
31	26	25			23	22			20	19					10	9					0	
0	0	0	0	0	0	0	7		7		480				960				0			

Reset

I2S_TX_PDM_FS Configures I2S PDM TX upsampling parameter. (R/W)

Register 29.9. I2S_RX_TDM_CTRL_REG (0x0050)

(reserved)												I2S_RX_TDM_TOT_CHAN_NUM																		I2S_RX_TDM_CHAN15_EN	I2S_RX_TDM_CHAN14_EN	I2S_RX_TDM_CHAN13_EN	I2S_RX_TDM_CHAN12_EN	I2S_RX_TDM_CHAN11_EN	I2S_RX_TDM_CHAN10_EN	I2S_RX_TDM_CHAN9_EN	I2S_RX_TDM_CHAN8_EN	I2S_RX_TDM_CHAN7_EN	I2S_RX_TDM_CHAN6_EN	I2S_RX_TDM_CHAN5_EN	I2S_RX_TDM_CHAN4_EN	I2S_RX_TDM_CHAN3_EN	I2S_RX_TDM_CHAN2_EN	I2S_RX_TDM_CHAN1_EN	I2S_RX_TDM_CHAN0_EN					
31																			16	15	14	13	12	11	10	9	8	7	6	5	4	3	2	1	0															
0 0 0 0 0 0 0 0 0 0 0 0												0x0																		1	1	1	1	1	1	1	1	1	1	1	1	1	1	1	1	1	1	1	1	1

I2S_RX_TDM_PDM_CHAN n _EN (n : 0-7) Configures whether to enable the valid data input of I2S RX TDM or PDM channel n .
 0: Disable. Channel n only inputs 0
 1: Enable
 (R/W)

I2S_RX_TDM_CHAN n _EN (n = 8-15) Configures whether to enable the valid data input of I2S RX TDM channel n .
 0: Disable. Channel n only inputs 0
 1: Enable
 (R/W)

I2S_RX_TDM_TOT_CHAN_NUM Configures the total number of channels in use in I2S RX TDM mode. Total channel number in use = I2S_RX_TDM_TOT_CHAN_NUM + 1. (R/W)

Register 29.10. I2S_RXEOF_NUM_REG (0x0064)

(reserved)																		I2S_RX_EOF_NUM																	
31																			12	11															0
0 0 0 0 0 0 0 0 0 0 0 0 0 0 0 0 0 0																		0x40																	

I2S_RX_EOF_NUM Configures the bit length of RX data. Bit length of RX data = (I2S_RX_BITS_MOD + 1) x (I2S_RX_EOF_NUM + 1). Once the received data reaches such bit length, a [GDMA_IN_SUC_EOF_CH \$n\$ _INT](#) interrupt is triggered in the configured DMA RX channel. (R/W)

Register 29.11. I2S_TX_CONF_REG (0x0024)

(reserved)	I2S_SIG_LOOPBACK	I2S_TX_CHAN_MOD	(reserved)	I2S_TX_PDM_EN	I2S_TX_TDM_EN	I2S_TX_BIT_ORDER	I2S_TX_WS_IDLE_POL	I2S_TX_24_FILL_EN	(reserved)	I2S_TX_ALIGN	I2S_TX_STOP_EN	I2S_TX_PCM_BYPASS	I2S_TX_PCM_CONF	I2S_TX_MONO_FST_VLD	I2S_TX_UPDATE	I2S_TX_BIG_ENDIAN	I2S_TX_CHAN_EQUAL	(reserved)	I2S_TX_SLAVE_MOD	I2S_TX_START	I2S_TX_FIFO_RESET	I2S_TX_RESET						
31	28	27	26	24	23	21	20	19	18	17	16	15	14	13	12	11	10	9	8	7	6	5	4	3	2	1	0	
0	0	0	0	0	0	0	0	0	0	0	0	1	0	1	1	0x0	1	0	0	0	0	0	0	0	0	0	0	0

I2S_TX_RESET Configures whether to reset TX unit.

- 0: No effect
 - 1: Reset
- (WT)

I2S_TX_FIFO_RESET Configures whether to reset TX FIFO.

- 0: No effect
 - 1: Reset
- (WT)

I2S_TX_START Configures whether to start transmitting data.

- 0: No effect
 - 1: Start
- (R/W/SC)

I2S_TX_SLAVE_MOD Configures whether to enable slave TX mode.

- 0: Disable
 - 1: Enable
- (R/W)

I2S_TX_MONO Configures whether to enable TX unit in mono mode.

- 0: Disable
 - 1: Enable
- (R/W)

I2S_TX_CHAN_EQUAL Configures whether to equalize left channel data and right channel data in I2S TX mono mode or TDM mode.

- 0: The I2S_SINGLE_DATA is invalid channel data in I2S TX mono mode or TDM mode
 - 1: The left channel data is equal to right channel data in I2S TX mono mode or TDM mode
- (R/W)

I2S_TX_BIG_ENDIAN Configures I2S TX byte endian.

- 0: Low address with low address value
 - 1: Low address value to high address
- (R/W)

Continued on the next page...

Register 29.11. I2S_TX_CONF_REG (0x0024)

Continued from the previous page...

I2S_TX_UPDATE Configures whether to update I2S TX registers from APB clock domain to I2S TX clock domain.

0: No effect

1: Update

This bit will be cleared by hardware after update register done.

(R/W/SC)

I2S_TX_MONO_FST_VLD Configures the valid data channel in I2S TX mono mode.

0: The second channel data valid

1: The first channel data valid

(R/W)

I2S_TX_PCM_CONF Configures the I2S TX compress/decompress mode.

0 (atol): A-law decompress

1 (ltoa) : A-law compress

2 (utol) : μ -law decompress

3 (ltou) : μ -law compress

(R/W)

I2S_TX_PCM_BYPASS Configures whether to bypass Compress/Decompress units for transmitted data.

0: No effect

1: Bypass

(R/W)

I2S_TX_STOP_EN Configures whether to stop outputting BCK signal and WS signal when TX FIFO is empty.

0: No effect

1: Stop

(R/W)

I2S_TX_LEFT_ALIGN Configures I2S TX alignment mode.

0: Right alignment mode

1: Left alignment mode

(R/W)

I2S_TX_24_FILL_EN Configures the bit number that the 24 channel bits are stored to.

0: Store 24-bit channel data to 24 bits

1: Store 24-bit channel data to 32 bits (Extra bits are filled with zeros)

(R/W)

I2S_TX_WS_IDLE_POL Configures the relationship between WS and which channel data to send.

0: WS remains low when sending left channel data and high when sending right channel data

1: WS remains high when sending left channel data and low when sending right channel data

(R/W)

Continued on the next page...

Register 29.11. I2S_TX_CONF_REG (0x0024)

Continued from the previous page...

I2S_TX_BIT_ORDER Configures I2S TX bit endian.

0: The highest bit is sent first

1: The lowest bit is sent first

(R/W)

I2S_TX_TDM_EN Configures whether to enable I2S TDM TX mode.

0: Disable

1: Enable

(R/W)

I2S_TX_PDM_EN Configures whether to enable I2S PDM TX mode.

0: Disable

1: Enable

(R/W)

I2S_TX_CHAN_MOD Configures I2S TX channel mode. For more information, see Table 29-7. (R/W)

I2S_SIG_LOOPBACK Configures whether to enable TX unit and RX unit sharing the same WS and BCK signals.

0: Disable

1: Enable

(R/W)

Register 29.12. I2S_TX_CONF1_REG (0x002C)

(reserved)		I2S_TX_BCK_NO_DLY		I2S_TX_MSB_SHIFT		I2S_TX_TDM_CHAN_BITS		I2S_TX_HALF_SAMPLE_BITS		I2S_TX_BITS_MOD		I2S_TX_BCK_DIV_NUM		I2S_TX_TDM_WS_WIDTH	
31	30	29	28	24	23	18	17	13	12	7	6				
0	1	1	0xf		0xf		0xf		6		0x0				

Reset

I2S_TX_TDM_WS_WIDTH Configures the width of tx_ws_out (WS default level) in TDM mode. The width of tx_ws_out (WS default level) in TDM mode = (I2S_TX_TDM_WS_WIDTH[6:0] + 1) x T_BCK. (R/W)

I2S_TX_BCK_DIV_NUM Configures the divider of BCK in TX mode. Note this divider must not be configured to 1. (R/W)

I2S_TX_BITS_MOD Configures the valid data bit length of I2S TX channel.

- 7: All the valid channel data is in 8-bit mode
- 15: All the valid channel data is in 16-bit mode
- 23: All the valid channel data is in 24-bit mode
- 31: All the valid channel data is in 32-bit mode

Other values are invalid. (R/W)

I2S_TX_HALF_SAMPLE_BITS Configures I2S TX sample bits. BCK cycles in one WS period = I2S_TX_HALF_SAMPLE_BITS x 2. (R/W)

I2S_TX_TDM_CHAN_BITS Configures TX bit number for each channel in TDM mode. Bit number expected = I2S_TX_TDM_CHAN_BITS + 1. (R/W)

I2S_TX_MSB_SHIFT Configures the timing between WS signal and the MSB of data.

- 0: Align at rising edge
- 1: WS signal changes one BCK clock earlier

(R/W)

I2S_TX_BCK_NO_DLY Configures whether BCK is delayed to generate rising/falling edge in master mode.

- 0: Delayed
- 1: Not delayed

(R/W)

Register 29.13. I2S_TX_TDM_CTRL_REG (0x0054)

(reserved)										I2S_TX_TDM_SKIP_MSK_EN															I2S_TX_TDM_TOT_CHAN_NUM	I2S_TX_TDM_CHAN15_EN															I2S_TX_TDM_CHAN14_EN	I2S_TX_TDM_CHAN13_EN	I2S_TX_TDM_CHAN12_EN	I2S_TX_TDM_CHAN11_EN	I2S_TX_TDM_CHAN10_EN	I2S_TX_TDM_CHAN9_EN	I2S_TX_TDM_CHAN8_EN	I2S_TX_TDM_CHAN7_EN	I2S_TX_TDM_CHAN6_EN	I2S_TX_TDM_CHAN5_EN	I2S_TX_TDM_CHAN4_EN	I2S_TX_TDM_CHAN3_EN	I2S_TX_TDM_CHAN2_EN	I2S_TX_TDM_CHAN1_EN	I2S_TX_TDM_CHAN0_EN
31																				21	20	19			16			15	14	13	12	11	10	9	8	7	6	5	4	3	2	1	0	Reset											
0 0 0 0 0 0 0 0 0 0										0	0x0			1	1	1	1	1	1	1	1	1	1	1	1	1	1	1	1	1	1	1	1	1	1																				

I2S_TX_TDM_CHAN n _EN (n : 0-15) Configures whether to enable the valid data output of I2S TX TDM channel n .
 0: Channel TX data is controlled by [I2S_TX_CHAN_EQUAL](#) and [I2S_SINGLE_DATA](#). See Section [29.9.2.1](#)
 1: Enable
 (R/W)

I2S_TX_TDM_TOT_CHAN_NUM Configures the total number of channels in use in I2S TX TDM mode. Total channel number in use = I2S_TX_TDM_TOT_CHAN_NUM + 1. (R/W)

I2S_TX_TDM_SKIP_MSK_EN Configures the data to be sent in DMA TX buffer.
 0: Data stored in DMA TX buffer is used by enabled channels and will not be read by channels that are not enabled.
 1: Data stored in DMA TX buffer is read by all channels and will be skipped by channels that are not enabled.
 (R/W)

Register 29.14. I2S_RX_TIMING_REG (0x0058)

(reserved)		I2S_RX_BCK_IN_DM		(reserved)		I2S_RX_WS_IN_DM		(reserved)		I2S_RX_BCK_OUT_DM		(reserved)		I2S_RX_WS_OUT_DM		(reserved)		I2S_RX_SD_IN_DM					
31	30	29	28	27	26	25	24	23	22	21	20	19	18	17	16	15			2	1	0		
0	0	0x0	0	0	0x0	0	0	0x0	0	0	0x0	0	0	0x0	0	0	0	0	0	0	0	0	0x0

Reset

I2S_RX_SD_IN_DM Configures the delay mode of I2S RX SD input signal.

- 0: Bypass
 - 1: Delay by rising edge
 - 2: Delay by falling edge
 - 3: Not used
- (R/W)

I2S_RX_WS_OUT_DM Configures the delay mode of I2S RX WS output signal. For detailed configuration values, please refer to [I2S_RX_SD_IN_DM](#). (R/W)

I2S_RX_BCK_OUT_DM Configures the delay mode of I2S RX BCK output signal. For detailed configuration values, please refer to [I2S_RX_SD_IN_DM](#). (R/W)

I2S_RX_WS_IN_DM Configures the delay mode of I2S RX WS input signal. For detailed configuration values, please refer to [I2S_RX_SD_IN_DM](#). (R/W)

I2S_RX_BCK_IN_DM Configures the delay mode of I2S RX BCK input signal. For detailed configuration values, please refer to [I2S_RX_SD_IN_DM](#). (R/W)

Register 29.15. I2S_TX_TIMING_REG (0x005C)

(reserved)	(reserved)	I2S_TX_BCK_IN_DM	(reserved)	(reserved)	I2S_TX_WS_IN_DM	(reserved)	(reserved)	I2S_TX_BCK_OUT_DM	(reserved)	(reserved)	(reserved)	(reserved)	(reserved)	(reserved)	(reserved)	(reserved)	(reserved)	(reserved)	(reserved)	I2S_TX_SD1_OUT_DM	(reserved)	I2S_TX_SD_OUT_DM	Reset								
31	30	29	28	27	26	25	24	23	22	21	20	19	18	17	16	15	14	13	12	11	10	9	8	7	6	5	4	3	2	1	0
0	0	0x0	0	0	0x0	0	0	0x0	0	0	0x0	0	0	0x0	0	0	0	0	0	0	0	0	0	0	0	0x0	0	0	0	0x0	

I2S_TX_SD_OUT_DM Configures the delay mode of I2S TX SD output signal.

- 0: Bypass
 - 1: Delay by rising edge
 - 2: Delay by falling edge
 - 3: Not used
- (R/W)

I2S_TX_SD1_OUT_DM Configures the delay mode of I2S TX SD1 output signal. For detailed configuration values, please refer to [I2S_TX_SD_OUT_DM](#). (R/W)

I2S_TX_WS_OUT_DM Configures the delay mode of I2S TX WS output signal. For detailed configuration values, please refer to [I2S_TX_SD_OUT_DM](#). (R/W)

I2S_TX_BCK_OUT_DM Configures the delay mode of I2S TX BCK output signal. For detailed configuration values, please refer to [I2S_TX_SD_OUT_DM](#). (R/W)

I2S_TX_WS_IN_DM Configures the delay mode of I2S TX WS input signal. For detailed configuration values, please refer to [I2S_TX_SD_OUT_DM](#). (R/W)

I2S_TX_BCK_IN_DM Configures the delay mode of I2S TX BCK input signal. For detailed configuration values, please refer to [I2S_TX_SD_OUT_DM](#). (R/W)

Register 29.16. I2S_LC_HUNG_CONF_REG (0x0060)

(reserved)														<i>I2S_LC_FIFO_TIMEOUT_ENA</i>		<i>I2S_LC_FIFO_TIMEOUT_SHIFT</i>		<i>I2S_LC_FIFO_TIMEOUT</i>			Reset	
31													12	11	10	8	7					0
0 0														1	0	0x10						

I2S_LC_FIFO_TIMEOUT Configures FIFO timeout threshold. **I2S_TX_HUNG_INT** or **I2S_RX_HUNG_INT** interrupt will be triggered when FIFO hung counter is equal to this value. (R/W)

I2S_LC_FIFO_TIMEOUT_SHIFT Configures tick counter threshold. The tick counter is reset when counter value $\geq 88000/2^{I2S_LC_FIFO_TIMEOUT_SHIFT}$. (R/W)

I2S_LC_FIFO_TIMEOUT_ENA Configures whether to enable FIFO timeout.
 0: Disable
 1: Enable
 (R/W)

Register 29.17. I2S_CONF_SIGLE_DATA_REG (0x0068)

<i>I2S_SINGLE_DATA</i>																																Reset
31																															0	
0																																

I2S_SINGLE_DATA Configures constant channel data to be sent out. (R/W)

Register 29.18. I2S_STATE_REG (0x006C)

(reserved)																														<i>I2S_TX_IDLE</i>		Reset
31																													1	0		
0 0																													1			

I2S_TX_IDLE Represents the TX unit state.
 0: I2S TX unit is working
 1: I2S TX unit is in idle state
 (RO)

Register 29.19. I2S_ETM_CONF_REG (0x0070)

<i>(reserved)</i>										<i>I2S_ETM_RX_RECEIVE_WORD_NUM</i>										<i>I2S_ETM_TX_SEND_WORD_NUM</i>																				
31											20	19											10	9											0					
0 0 0 0 0 0 0 0 0 0										0 0 0 0 0 0 0 0 0 0										0x40										0x40										Reset

I2S_ETM_TX_SEND_WORD_NUM Configures the threshold of triggering ETM I2S_TX_X_WORDS_SENT event. When sending word number of I2S_ETM_TX_SEND_WORD_NUM [9:0], I2S will trigger the corresponding ETM event. (R/W)

I2S_ETM_RX_RECEIVE_WORD_NUM Configures the threshold of triggering ETM I2S_RX_X_WORDS_RECEIVED event. When receiving word number of I2S_ETM_RX_RECEIVE_WORD_NUM [9:0], I2S will trigger the corresponding ETM event. (R/W)

Register 29.20. I2S_DATE_REG (0x0080)

<i>(reserved)</i>				<i>I2S_DATE</i>																												
31				28	27																											0
0 0 0 0				0x2201070																												Reset

I2S_DATE Version control register. (R/W)

30 Pulse Count Controller (PCNT)

The pulse count controller (PCNT) is designed to count input pulses. It can increment or decrement a pulse counter value by keeping track of rising (positive) or falling (negative) edges of the input pulse signal. The PCNT has four independent pulse counters called units, which have their groups of registers. There is only one clock in PCNT, which is APB_CLK. In this chapter, n denotes the number of a unit from 0 ~ 3.

Each unit includes two channels (ch0 and ch1) which can independently increment or decrement its pulse counter value. The remainder of the chapter will mostly focus on channel 0 (ch0) as the functionality of the two channels is identical.

As shown in Figure 30-1, each channel has two input signals:

1. One input pulse signal (e.g. sig_ch0_un, the input pulse signal for ch0 of unit n ch0)
2. One control signal (e.g. ctrl_ch0_un, the control signal for ch0 of unit n ch0)

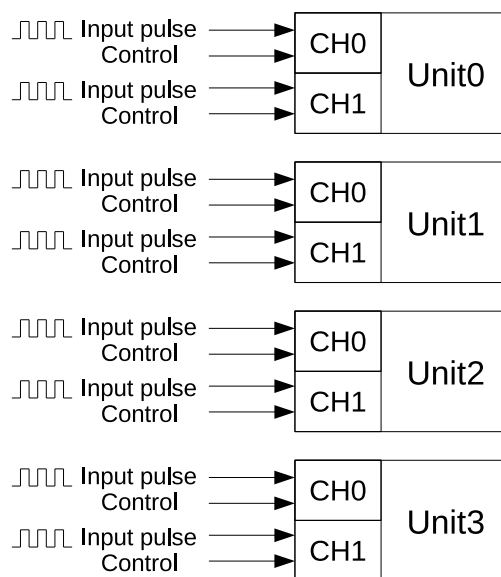

Figure 30-1. PCNT Block Diagram

30.1 Features

A PCNT has the following features:

- Four independent pulse counters (units) that count from 1 to 65535
- Each unit consists of two independent channels sharing one pulse counter
- All channels have input pulse signals (e.g. sig_ch0_un) with their corresponding control signals (e.g. ctrl_ch0_un)
- Independently filter glitches of input pulse signals (sig_ch0_un and sig_ch1_un) and control signals (ctrl_ch0_un and ctrl_ch1_un) on each unit
- Each channel has the following parameters:
 1. Selection between counting on positive or negative edges of the input pulse signal

- Configuration to Increment, Decrement, or Disable counter mode for control signal's high and low states

- Maximum frequency of pulses: $\frac{f_{APB_CLK}}{2}$

30.2 Functional Description

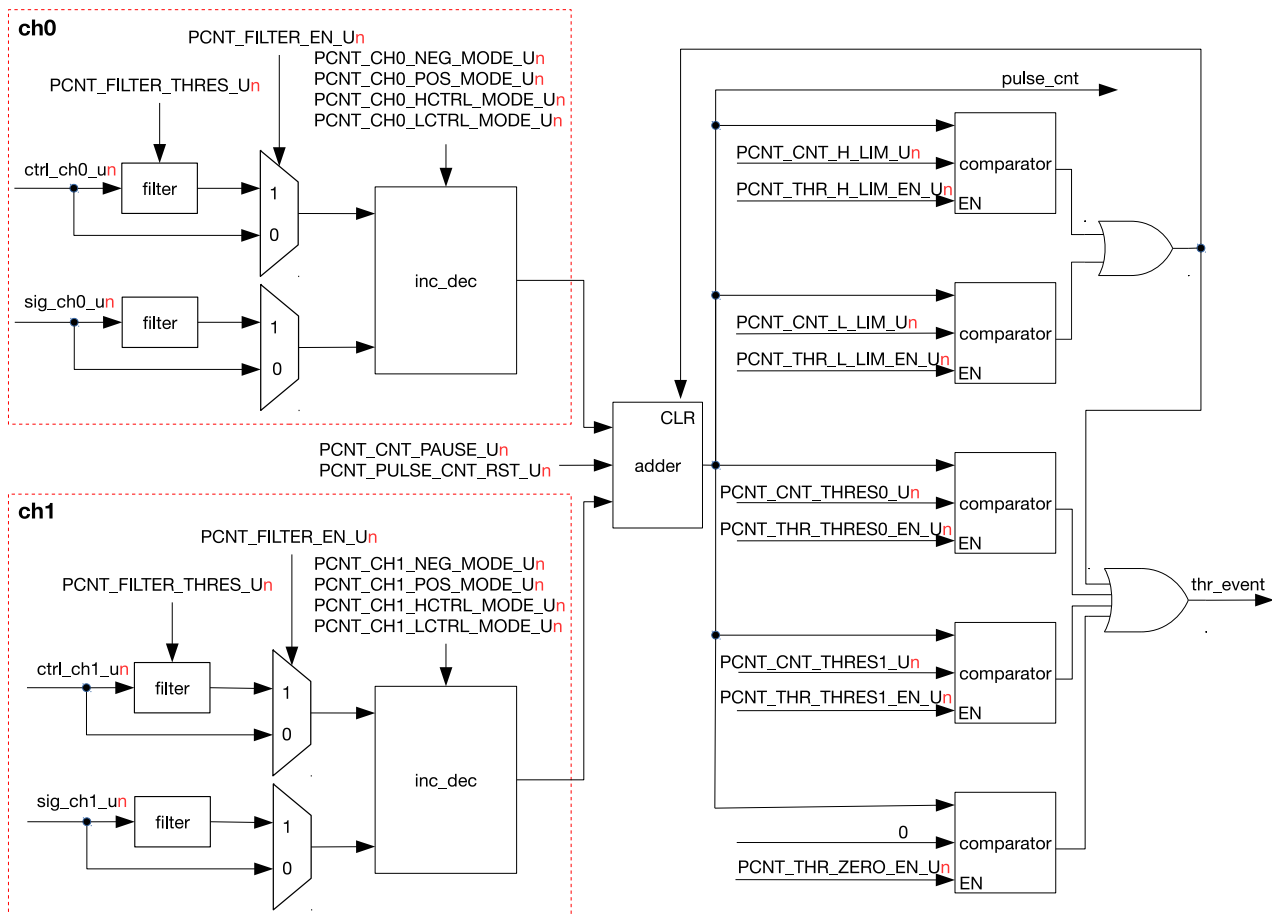

Figure 30-2. PCNT Unit Architecture

Figure 30-2 shows PCNT's architecture. As stated above, `ctrl_ch0_un` is the control signal for ch0 of unit n . Its high and low states can be assigned different counter modes and used for pulse counting of the channel's input pulse signal `sig_ch0_un` on negative or positive edges. The available counter modes are as follows:

- Increment mode: When a channel detects an active edge of `sig_ch0_un` (can be configured by software), the counter value `pulse_cnt` increases by 1. Upon reaching `PCNT_CNT_H_LIM_Un`, `pulse_cnt` is cleared. If the channel's counter mode is changed or if `PCNT_CNT_PAUSE_Un` is set before `pulse_cnt` reaches `PCNT_CNT_H_LIM_Un`, then `pulse_cnt` freezes and its counter mode changes.
- Decrement mode: When a channel detects an active edge of `sig_ch0_un` (can be configured by software), the counter value `pulse_cnt` decreases by 1. Upon reaching `PCNT_CNT_L_LIM_Un`, `pulse_cnt` is cleared. If the channel's counter mode is changed or if `PCNT_CNT_PAUSE_Un` is set before `pulse_cnt` reaches `PCNT_CNT_L_LIM_Un`, then `pulse_cnt` freezes and its counter mode changes.
- Disable mode: Counting is disabled, and the counter value `pulse_cnt` freezes.

Table 30-1 to Table 30-4 provide information on how to configure the counter mode for channel 0.

Table 30-1. Counter Mode. Positive Edge of Input Pulse Signal. Control Signal in Low State

PCNT_CH0_POS_MODE_U _n	PCNT_CH0_LCTRL_MODE_U _n	Counter Mode
1	0	Increment
	1	Decrement
	Others	Disable
2	0	Decrement
	1	Increment
	Others	Disable
Others	N/A	Disable

Table 30-2. Counter Mode. Positive Edge of Input Pulse Signal. Control Signal in High State

PCNT_CH0_POS_MODE_U _n	PCNT_CH0_HCTRL_MODE_U _n	Counter Mode
1	0	Increment
	1	Decrement
	Others	Disable
2	0	Decrement
	1	Increment
	Others	Disable
Others	N/A	Disable

Table 30-3. Counter Mode. Negative Edge of Input Pulse Signal. Control Signal in Low State

PCNT_CH0_NEG_MODE_U _n	PCNT_CH0_LCTRL_MODE_U _n	Counter Mode
1	0	Increment
	1	Decrement
	Others	Disable
2	0	Decrement
	1	Increment
	Others	Disable
Others	N/A	Disable

Table 30-4. Counter Mode. Negative Edge of Input Pulse Signal. Control Signal in High State

PCNT_CH0_NEG_MODE_U _n	PCNT_CH0_HCTRL_MODE_U _n	Counter Mode
1	0	Increment
	1	Decrement
	Others	Disable
2	0	Decrement
	1	Increment
	Others	Disable
Others	N/A	Disable

Each unit has one filter for all its control and input pulse signals. A filter can be enabled with the bit `PCNT_FILTER_EN_Un`. The filter monitors the signals and ignores all the noise, i.e. the glitches with pulse widths shorter than `PCNT_FILTER_THRES_Un` APB clock cycles in length.

As shown on Figure 30-2, each unit has two channels which process different input pulse signals and increase or decrease values via their respective inc_dec modules, then the two channels send these values to the adder module which has a 16-bit wide signed register. This adder can be suspended by setting `PCNT_CNT_PAUSE_Un`, and cleared by setting `PCNT_PULSE_CNT_RST_Un`.

The PCNT has five watchpoints that share one interrupt. The interrupt can be enabled or disabled by interrupt enable signals of each individual watchpoint.

- Maximum count value: When pulse_cnt reaches `PCNT_CNT_H_LIM_Un`, a high limit interrupt is triggered and `PCNT_CNT_THR_H_LIM_LAT_Un` is high.
- Minimum count value: When pulse_cnt reaches `PCNT_CNT_L_LIM_Un`, a low limit interrupt is triggered and `PCNT_CNT_THR_L_LIM_LAT_Un` is high.
- Two threshold values: When pulse_cnt equals either `PCNT_CNT_THRES0_Un` or `PCNT_CNT_THRES1_Un`, an interrupt is triggered and either `PCNT_CNT_THR_THRES0_LAT_Un` or `PCNT_CNT_THR_THRES1_LAT_Un` is high respectively.
- Zero: When pulse_cnt is 0, an interrupt is triggered and `PCNT_CNT_THR_ZERO_LAT_Un` is valid.

If `PCNT_CNT_H_LIM_Un` and/or `PCNT_CNT_L_LIM_Un` are reconfigured by software when PCNT is working, the new configuration will take effect after pulse_cnt counts to any of the above five watchpoints; If `PCNT_CNT_THRES0_Un` and/or `PCNT_CNT_THRES1_Un` are reconfigured by software, the new configuration will take effect immediately.

30.3 Applications

In each unit, channel 0 and channel 1 can be configured to work independently or together. The three subsections below provide details of channel 0 incrementing independently, channel 0 decrementing independently, and channel 0 and channel 1 incrementing together. For other working modes not elaborated in this section (e.g. channel 1 incrementing/decrementing independently, or one channel incrementing while the other decrementing), reference can be made to these three subsections.

30.3.1 Channel 0 Incrementing Independently

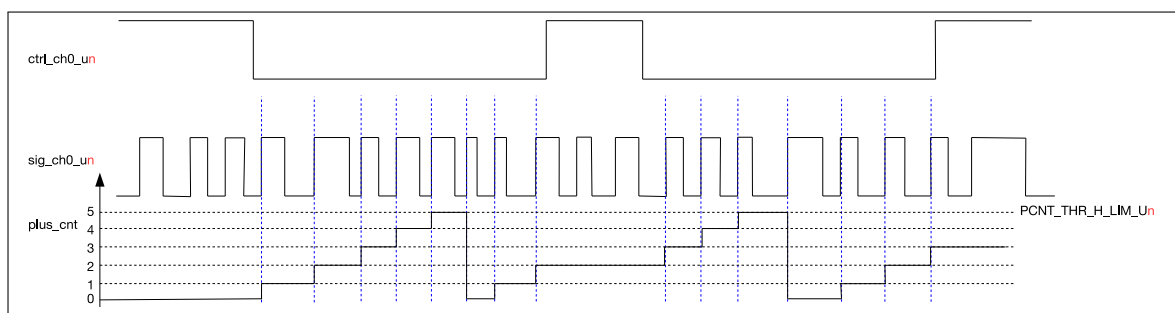

Figure 30-3. Channel 0 Up Counting Diagram

Figure 30-3 illustrates how channel 0 is configured to increment independently on the positive edge of `sig_ch0_un` while channel 1 is disabled (see subsection 30.2 for how to disable channel 1). The configuration of channel 0 is shown below.

- `PCNT_CH0_LCTRL_MODE_Un=0`: When `ctrl_ch0_un` is low, the counter mode specified for the low state turns on, in this case it is Increment mode.
- `PCNT_CH0_HCTRL_MODE_Un=2`: When `ctrl_ch0_un` is high, the counter mode specified for the low state turns on, in this case it is Disable mode.
- `PCNT_CH0_POS_MODE_Un=1`: The counter increments on the positive edge of `sig_ch0_un`.
- `PCNT_CH0_NEG_MODE_Un=0`: The counter idles on the negative edge of `sig_ch0_un`.
- `PCNT_CNT_H_LIM_Un=5`: When `pulse_cnt` counts up to `PCNT_CNT_H_LIM_Un`, it is cleared.

30.3.2 Channel 0 Decrementing Independently

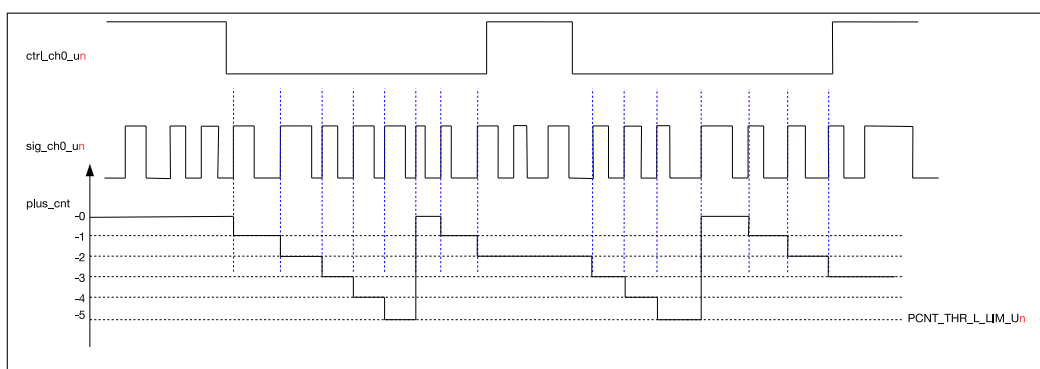

Figure 30-4. Channel 0 Down Counting Diagram

Figure 30-4 illustrates how channel 0 is configured to decrement independently on the positive edge of `sig_ch0_un` while channel 1 is disabled. The configuration of channel 0 in this case differs from that in Figure 30-3 in the following aspects:

- `PCNT_CH0_POS_MODE_Un=2`: the counter decrements on the positive edge of `sig_ch0_un`.
- `PCNT_CNT_L_LIM_Un=-5`: when `pulse_cnt` counts down to `PCNT_CNT_L_LIM_Un`, it is cleared.

30.3.3 Channel 0 and Channel 1 Incrementing Together

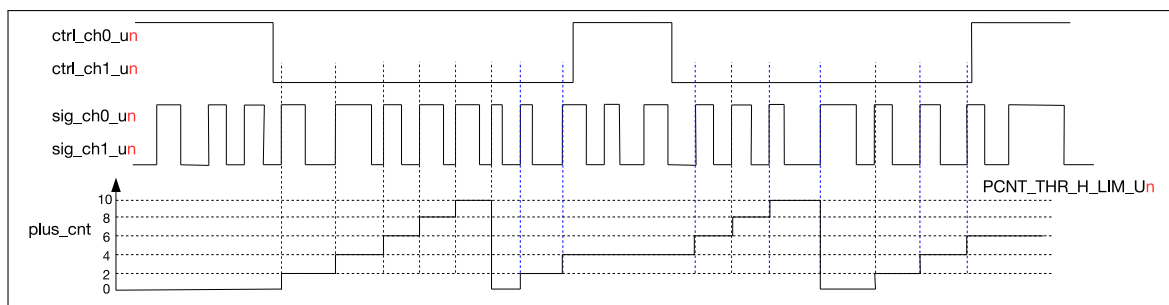

Figure 30-5. Two Channels Up Counting Diagram

Figure 30-5 illustrates how channel 0 and channel 1 are configured to increment on the positive edge of `sig_ch0_un` and `sig_ch1_un` respectively at the same time. It can be seen in Figure 30-5 that control signal `ctrl_ch0_un` and `ctrl_ch1_un` have the same waveform, so as input pulse signal `sig_ch0_un` and `sig_ch1_un`. The configuration procedure is shown below.

- For channel 0:
 - `PCNT_CH0_LCTRL_MODE_Un=0`: When `ctrl_ch0_un` is low, the counter mode specified for the low state turns on, in this case it is Increment mode.
 - `PCNT_CH0_HCTRL_MODE_Un=2`: When `ctrl_ch0_un` is high, the counter mode specified for the low state turns on, in this case it is Disable mode.
 - `PCNT_CH0_POS_MODE_Un=1`: The counter increments on the positive edge of `sig_ch0_un`.
 - `PCNT_CH0_NEG_MODE_Un=0`: The counter idles on the negative edge of `sig_ch0_un`.
- For channel 1:
 - `PCNT_CH1_LCTRL_MODE_Un=0`: When `ctrl_ch1_un` is low, the counter mode specified for the low state turns on, in this case it is Increment mode.
 - `PCNT_CH1_HCTRL_MODE_Un=2`: When `ctrl_ch1_un` is high, the counter mode specified for the low state turns on, in this case it is Disable mode.
 - `PCNT_CH1_POS_MODE_Un=1`: The counter increments on the positive edge of `sig_ch1_un`.
 - `PCNT_CH1_NEG_MODE_Un=0`: The counter idles on the negative edge of `sig_ch1_un`.
- `PCNT_CNT_H_LIM_Un=10`: When `pulse_cnt` counts up to `PCNT_CNT_H_LIM_Un`, it is cleared.

30.4 Register Summary

The addresses in this section are relative to **Pulse Count Controller** base address provided in Table 5-2 in Chapter 5 *System and Memory*.

The abbreviations given in Column **Access** are explained in Section *Access Types for Registers*.

Name	Description	Address	Access
Configuration Register			
PCNT_U0_CONF0_REG	Configuration register 0 for unit 0	0x0000	R/W
PCNT_U0_CONF1_REG	Configuration register 1 for unit 0	0x0004	R/W
PCNT_U0_CONF2_REG	Configuration register 2 for unit 0	0x0008	R/W
PCNT_U1_CONF0_REG	Configuration register 0 for unit 1	0x000C	R/W
PCNT_U1_CONF1_REG	Configuration register 1 for unit 1	0x0010	R/W
PCNT_U1_CONF2_REG	Configuration register 2 for unit 1	0x0014	R/W
PCNT_U2_CONF0_REG	Configuration register 0 for unit 2	0x0018	R/W
PCNT_U2_CONF1_REG	Configuration register 1 for unit 2	0x001C	R/W
PCNT_U2_CONF2_REG	Configuration register 2 for unit 2	0x0020	R/W
PCNT_U3_CONF0_REG	Configuration register 0 for unit 3	0x0024	R/W
PCNT_U3_CONF1_REG	Configuration register 1 for unit 3	0x0028	R/W
PCNT_U3_CONF2_REG	Configuration register 2 for unit 3	0x002C	R/W
PCNT_CTRL_REG	Control register for all counters	0x0060	R/W
Status Register			
PCNT_U0_CNT_REG	Counter value for unit 0	0x0030	RO
PCNT_U1_CNT_REG	Counter value for unit 1	0x0034	RO
PCNT_U2_CNT_REG	Counter value for unit 2	0x0038	RO
PCNT_U3_CNT_REG	Counter value for unit 3	0x003C	RO
PCNT_U0_STATUS_REG	PNCT UNIT0 status register	0x0050	RO
PCNT_U1_STATUS_REG	PNCT UNIT1 status register	0x0054	RO
PCNT_U2_STATUS_REG	PNCT UNIT2 status register	0x0058	RO
PCNT_U3_STATUS_REG	PNCT UNIT3 status register	0x005C	RO
Interrupt Register			
PCNT_INT_RAW_REG	Interrupt raw status register	0x0040	RO
PCNT_INT_ST_REG	Interrupt status register	0x0044	RO
PCNT_INT_ENA_REG	Interrupt enable register	0x0048	R/W
PCNT_INT_CLR_REG	Interrupt clear register	0x004C	WO
Version Register			
PCNT_DATE_REG	PCNT version control register	0x00FC	R/W

30.5 Registers

The addresses in this section are relative to **Pulse Count Controller** base address provided in Table 5-2 in Chapter 5 *System and Memory*.

Register 30.1. PCNT_U_n_CONF0_REG (*n*: 0-3) (0x0000+0xC**n*)

PCNT_CH1_LCTRL_MODE_U0		PCNT_CH1_HCTRL_MODE_U0		PCNT_CH1_POS_MODE_U0		PCNT_CH1_NEG_MODE_U0		PCNT_CH0_LCTRL_MODE_U0		PCNT_CH0_HCTRL_MODE_U0		PCNT_CH0_POS_MODE_U0		PCNT_CH0_NEG_MODE_U0		PCNT_THR_THRES1_EN_U0		PCNT_THR_THRES0_EN_U0		PCNT_THR_L_LIM_EN_U0		PCNT_THR_H_LIM_EN_U0		PCNT_THR_ZERO_EN_U0		PCNT_FILTER_THRES_U0		
31	30	29	28	27	26	25	24	23	22	21	20	19	18	17	16	15	14	13	12	11	10	9					0	
0x0	0x0	0x0	0x0	0x0	0x0	0x0	0x0	0x0	0x0	0x0	0x0	0x0	0x0	0	0	1	1	1	1	0x10								Reset

PCNT_FILTER_THRES_U_n Configures the maximum threshold for the filter. Any pulses with width less than this will be ignored when the filter is enabled.

Measurement unit: APB_CLK cycles.

(R/W)

PCNT_FILTER_EN_U_n This is the enable bit for unit *n*'s input filter. (R/W)

PCNT_THR_ZERO_EN_U_n This is the enable bit for unit *n*'s zero comparator. (R/W)

PCNT_THR_H_LIM_EN_U_n This is the enable bit for unit *n*'s thr_h_lim comparator. Configures it to enable the high limit interrupt.(R/W)

PCNT_THR_L_LIM_EN_U_n This is the enable bit for unit *n*'s thr_l_lim comparator. Configures it to enable the low limit interrupt.(R/W)

PCNT_THR_THRES0_EN_U_n This is the enable bit for unit *n*'s thres0 comparator. (R/W)

PCNT_THR_THRES1_EN_U_n This is the enable bit for unit *n*'s thres1 comparator. (R/W)

PCNT_CH0_NEG_MODE_U_n Configures the behavior when the signal input of channel 0 detects a negative edge.

- 1: Increment the counter
- 2: Decrement the counter
- 0, 3: No effect

(R/W)

PCNT_CH0_POS_MODE_U_n Configures the behavior when the signal input of channel 0 detects a positive edge.

- 1: Increment the counter
- 2: Decrement the counter
- 0, 3: No effect

(R/W)

PCNT_CH0_HCTRL_MODE_U_n Configures how the CH_{*n*}_POS_MODE/CH_{*n*}_NEG_MODE settings will be modified when the control signal is high.

- 0: No modification
- 1: Invert behavior (increase -> decrease, decrease -> increase)
- 2, 3: Inhibit counter modification

(R/W)

Continued on the next page...

Register 30.1. PCNT_U n _CONF0_REG (n : 0-3) (0x0000+0xC* n)

Continued from the previous page...

PCNT_CH0_LCTRL_MODE_U n Configures how the CH n _POS_MODE/CH n _NEG_MODE settings will be modified when the control signal is low.

0: No modification

1: Invert behavior (increase -> decrease, decrease -> increase)

2, 3: Inhibit counter modification

(R/W)

PCNT_CH1_NEG_MODE_U n Configures the behavior when the signal input of channel 1 detects a negative edge.

1: Increment the counter

2: Decrement the counter

0, 3: No effect

(R/W)

PCNT_CH1_POS_MODE_U n Configures the behavior when the signal input of channel 1 detects a positive edge.

1: Increment the counter

2: Decrement the counter

0, 3: No effect

(R/W)

PCNT_CH1_HCTRL_MODE_U n Configures how the CH n _POS_MODE/CH n _NEG_MODE settings will be modified when the control signal is high.

0: No modification

1: Invert behavior (increase -> decrease, decrease -> increase)

2, 3: Inhibit counter modification

(R/W)

PCNT_CH1_LCTRL_MODE_U n Configures how the CH n _POS_MODE/CH n _NEG_MODE settings will be modified when the control signal is low.

0: No modification

1: Invert behavior (increase -> decrease, decrease -> increase)

2, 3: Inhibit counter modification

(R/W)

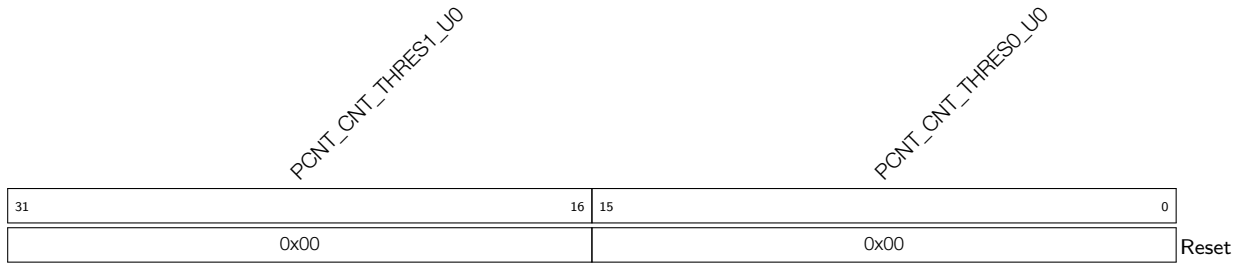
Register 30.2. PCNT_UN_CONF1_REG (n : 0-3) (0x0004+0xC*n)

PCNT_CNT_THRES0_UN Configures the thres0 value for unit n . (R/W)

PCNT_CNT_THRES1_UN Configures the thres1 value for unit n . (R/W)

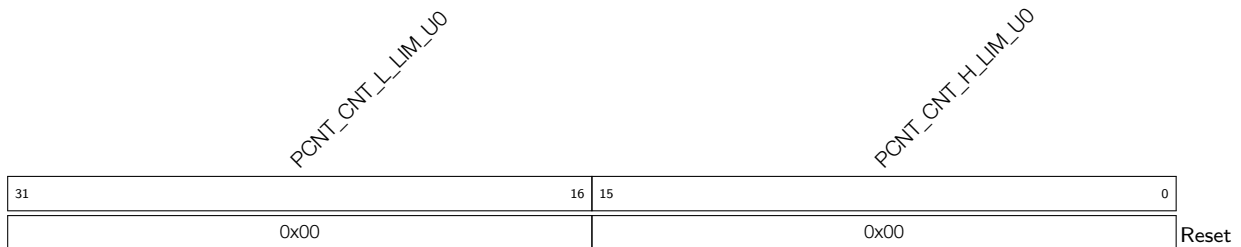
Register 30.3. PCNT_UN_CONF2_REG (n : 0-3) (0x0008+0xC*n)

PCNT_CNT_H_LIM_UN Configures the thr_h_lim value for unit n . When pulse_cnt reaches this value, the counter will be cleared to 0. (R/W)

PCNT_CNT_L_LIM_UN Configures the thr_l_lim value for unit n . When pulse_cnt reaches this value, the counter will be cleared to 0.(R/W)

Register 30.4. PCNT_CTRL_REG (0x0060)

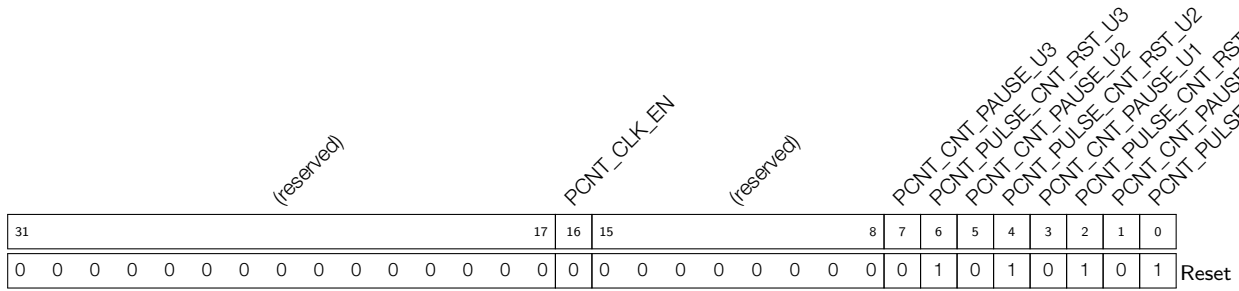

PCNT_PULSE_CNT_RST_U n Write 1 to clear unit n 's counter.

0: No effect

1: Clear

(R/W)

PCNT_CNT_PAUSE_U n Write 1 to freeze unit n 's counter.

0: No effect

1: Freeze

(R/W)

PCNT_CLK_EN Configures whether or not to enable the registers clock gate of PCNT module.

0: the clock for registers is enabled when registers are read and written

1: the clock for registers is always on

(R/W)

Register 30.5. PCNT_U n _CNT_REG (n : 0-3) (0x0030+0x4* n)

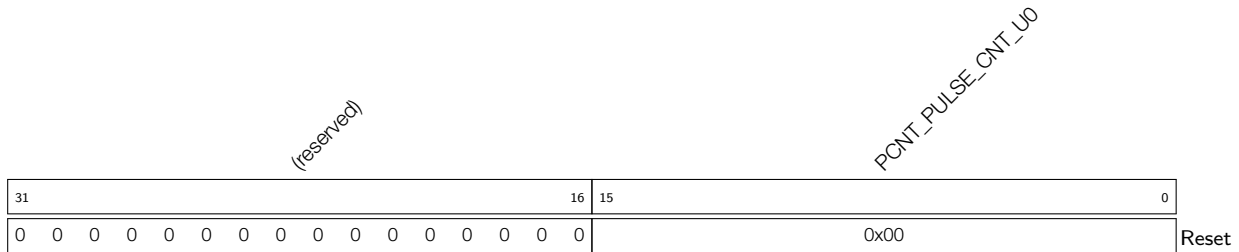

PCNT_PULSE_CNT_U n Represents the current pulse count value for unit n . (RO)

Register 30.6. PCNT_U n _STATUS_REG (n : 0-3) (0x0050+0x4* n)

(reserved)															PCNT_CNT_THR_ZERO_LAT_U0 PCNT_CNT_THR_H_LIM_LAT_U0 PCNT_CNT_THR_L_LIM_LAT_U0 PCNT_CNT_THR_THRES0_LAT_U0 PCNT_CNT_THR_THRES1_LAT_U0 PCNT_CNT_THR_ZERO_MODE_U0								
31															7	6	5	4	3	2	1	0	
0	0	0	0	0	0	0	0	0	0	0	0	0	0	0	0	0	0	0	0	0	0	0x0	Reset

PCNT_CNT_THR_ZERO_MODE_U n Represents the pulse counter status of PCNT_U n corresponding to 0.

- 0: pulse counter decreases from positive to 0
 - 1: pulse counter increases from negative to 0
 - 2: pulse counter is negative
 - 3: pulse counter is positive
- (RO)

PCNT_CNT_THR_THRES1_LAT_U n Represents the latched value of thres1 event of PCNT_U n when threshold event interrupt is valid.

- 0: others
 - 1: the current pulse counter equals to thres1 and thres1 event is valid
- (RO)

PCNT_CNT_THR_THRES0_LAT_U n Represents the latched value of thres0 event of PCNT_U n when threshold event interrupt is valid.

- 0: others
 - 1: the current pulse counter equals to thres0 and thres0 event is valid
- (RO)

PCNT_CNT_THR_L_LIM_LAT_U n Represents the latched value of low limit event of PCNT_U n when threshold event interrupt is valid.

- 0: others
 - 1: the current pulse counter equals to thr_l_lim and low limit event is valid.
- (RO)

PCNT_CNT_THR_H_LIM_LAT_U n Represents the latched value of high limit event of PCNT_U n when threshold event interrupt is valid.

- 0: others
 - 1: the current pulse counter equals to thr_h_lim and high limit event is valid.
- (RO)

PCNT_CNT_THR_ZERO_LAT_U n Represents the latched value of zero threshold event of PCNT_U n when threshold event interrupt is valid.

- 0: others
 - 1: the current pulse counter equals to 0 and zero threshold event is valid.
- (RO)

Register 30.7. PCNT_INT_RAW_REG (0x0040)

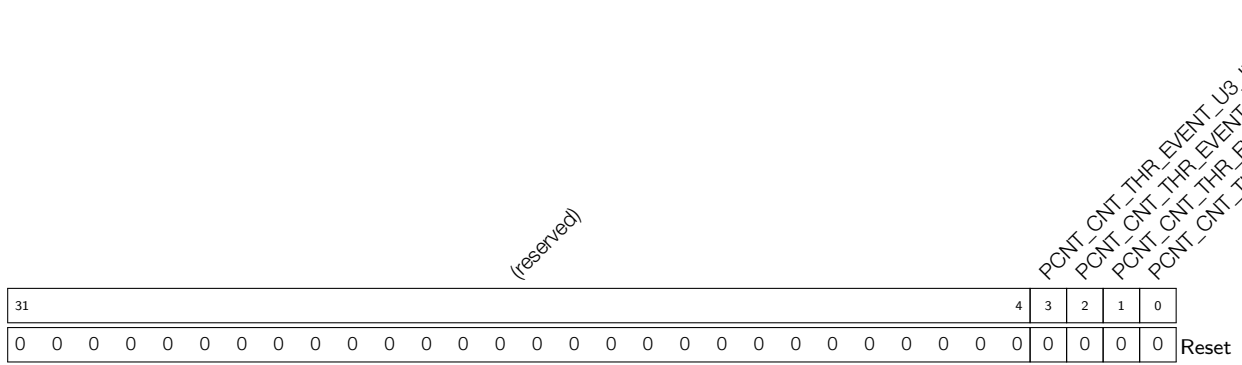

PCNT_CNT_THR_EVENT_U n _INT_RAW The raw interrupt status of the PCNT_CNT_THR_EVENT_U n _INT interrupt. (RO)

Register 30.8. PCNT_INT_ST_REG (0x0044)

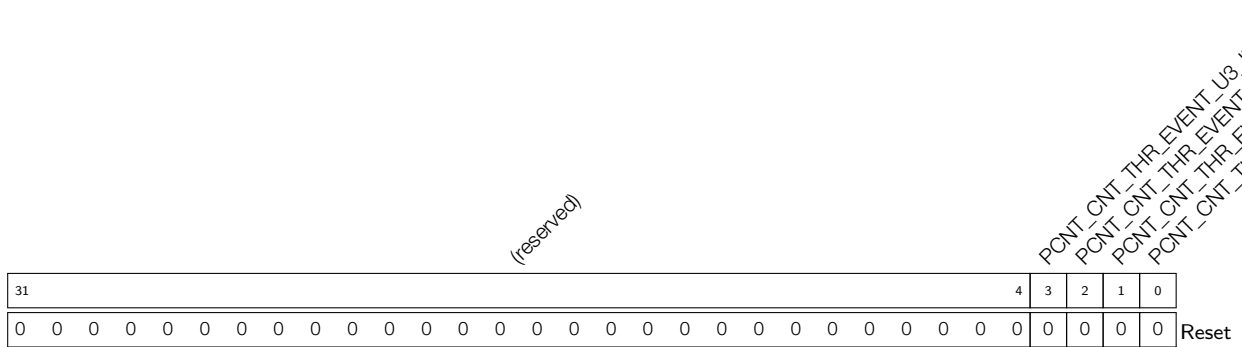

PCNT_CNT_THR_EVENT_U n _INT_ST The masked interrupt status of the PCNT_CNT_THR_EVENT_U n _INT interrupt. (RO)

Register 30.9. PCNT_INT_ENA_REG (0x0048)

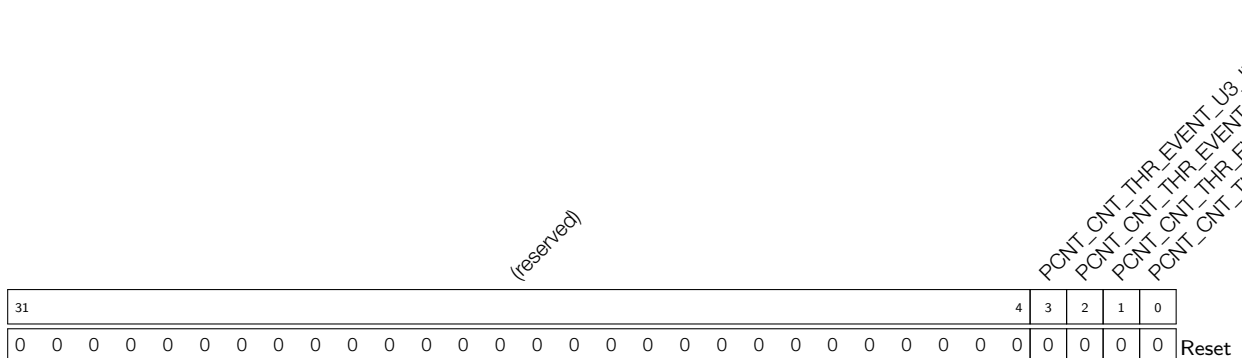

PCNT_CNT_THR_EVENT_U n _INT_ENA Write 1 to enable the PCNT_CNT_THR_EVENT_U n _INT interrupt. (R/W)

Register 30.10. PCNT_INT_CLR_REG (0x004C)

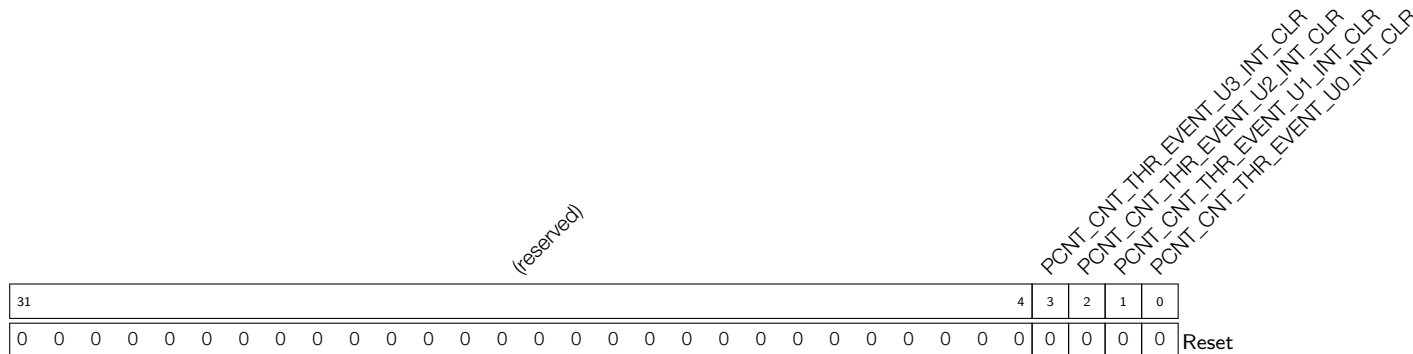

PCNT_CNT_THR_EVENT_U_nINT_CLR Write 1 to clear the PCNT_CNT_THR_EVENT_U_nINT interrupt. (WO)

Register 30.11. PCNT_DATE_REG (0x00FC)

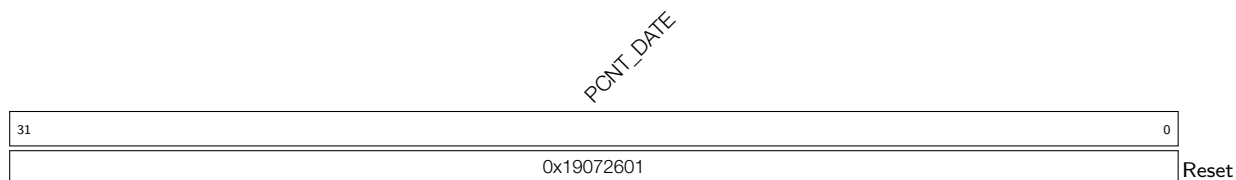

PCNT_DATE Version control register. (R/W)

31 USB Serial/JTAG Controller (USB_SERIAL_JTAG)

ESP32-C6 contains a USB Serial/JTAG Controller. This unit can be used to program the SoC's flash, read program output, as well as attach a debugger to the running program. All of these are possible for any computer with a USB host (hereafter referred to as 'host') without any active external components.

31.1 Overview

While programming and debugging an ESP32-C6 project using the UART and JTAG functionality is certainly possible, it has a few downsides. First of all, both UART and JTAG take up IO pins and as such, fewer pins are left usable for controlling external signals in software. Additionally, an external chip or adapter is needed for both UART and JTAG to interface with a host computer, which means it will be necessary to integrate these two functionalities in the form of external chips or debugging adapters.

In order to alleviate these issues, ESP32-C6 provides a USB Serial/JTAG Controller, which integrates the functionality of both a USB-to-serial converter as well as a USB-to-JTAG adapter. As this device directly interfaces with an external USB host using only the two data lines required by USB 2.0, only two pins are required to be dedicated to this functionality for debugging ESP32-C6.

31.2 Features

The USB Serial/JTAG controller has the following features:

- USB Full-speed device; Hardwired for CDC-ACM (Communication Device Class - Abstract Control Model) and JTAG adapter functionality
- CDC-ACM:
 - Integrates CDC-ACM adherent serial port emulation (plug-and-play on most modern OSes)
 - Supports host controllable chip reset and entry into download mode
- JTAG adapter functionality:
 - Allows fast communication with CPU debugging core using a compact representation of JTAG instructions
- Two OUT Endpoints and three IN Endpoints in addition to Control Endpoint 0; Up to 64-byte data payload size
- Internal PHY: very few or no external components needed to connect to a host computer

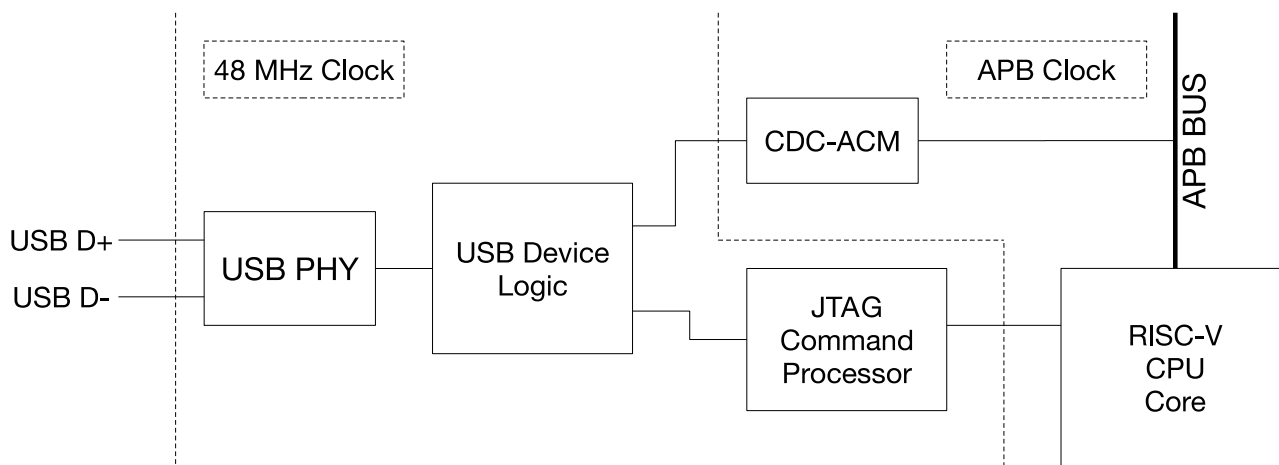

Figure 31-1. USB Serial/JTAG High Level Diagram

As shown in Figure 31-1, the USB Serial/JTAG controller consists of a USB PHY, a USB device interface, a JTAG command processor, a response capture unit, and the CDC-ACM registers. The PHY and device interface are clocked from a 48 MHz clock derived from the baseband PLL (BBPLL); the software-accessible side of the CDC-ACM block is clocked from APB_CLK. The JTAG command processor is connected to the JTAG debugging unit of the main processor; the CDC-ACM registers are connected to the APB bus and as such can be read from and written to by software running on the main CPU.

Note that while the USB Serial/JTAG device supports USB 2.0 standard, it only supports Full-speed (12 Mbps) mode but not other modes that the USB 2.0 standard introduced, e.g., the High-speed (480 Mbps) mode.

Figure 31-2 shows the internal details of the USB Serial/JTAG controller on the USB side. The USB Serial/JTAG controller consists of a USB 2.0 Full-speed device. It contains a control endpoint, a dummy interrupt endpoint, two bulk input endpoints, and two bulk output endpoints. Together, these form a USB composite device, which consists of a CDC-ACM USB class device as well as a vendor-specific device implementing the JTAG interface. On the SoC side, the JTAG interface is directly connected to the RISC-V CPU's debugging interface, allowing debugging of programs running on that core. Meanwhile, the CDC-ACM device is exposed as a set of registers, allowing a program on the CPU to read and write from it. Additionally, the ROM startup code of the SoC contains code that allows the user to reprogram attached flash memory using this interface.

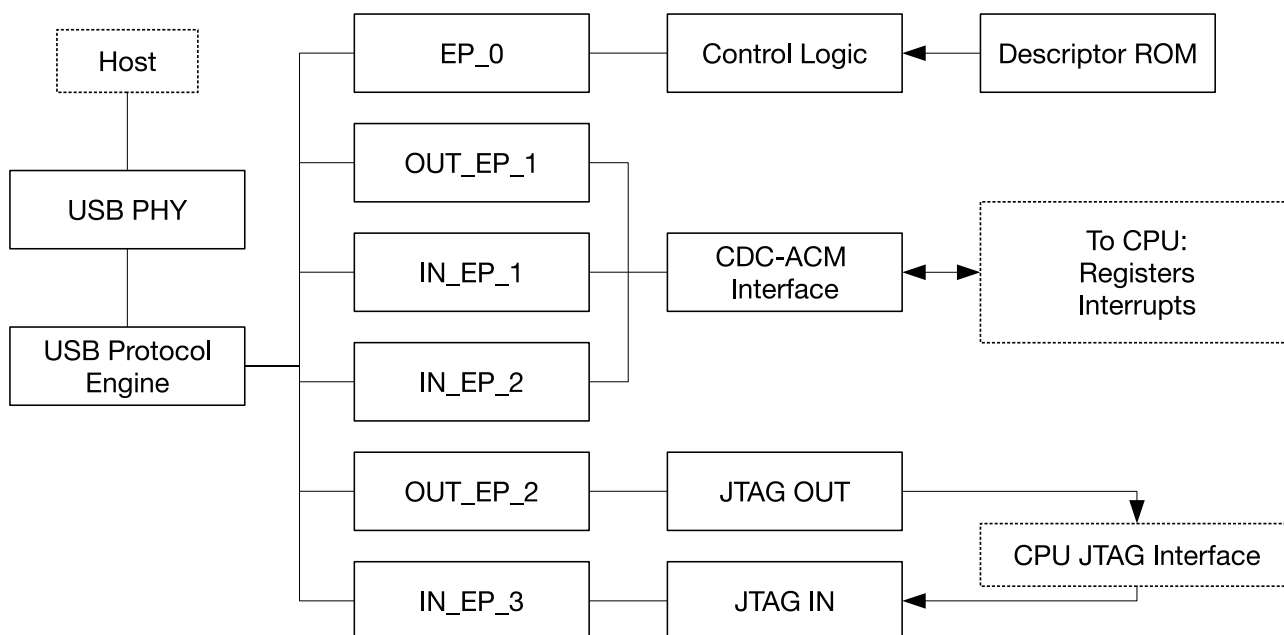

Figure 31-2. USB Serial/JTAG Block Diagram

31.3 Functional Description

The USB Serial/JTAG controller interfaces with a USB host processor on one side, and with the CPU debugging hardware as well as the software that communicates through the CDC-ACM port on the other side.

31.3.1 CDC-ACM USB Interface Functional Description

The CDC-ACM interface adheres to the standard USB CDC-ACM class for serial port emulation. It contains a dummy interrupt endpoint (which will never send any events, as they are not implemented nor needed) and a Bulk IN as well as a Bulk OUT endpoint for the host's received and sent serial data respectively. These endpoints can handle 64-byte packets at a time, allowing high throughput. As CDC-ACM is a standard USB device class, a host generally can function without any special installation procedures. That is to say, when the USB debugging device is properly connected to a host, the operating system should show a new serial port moments later.

The CDC-ACM interface accepts the following standard CDC-ACM control requests:

Table 31-1. Standard CDC-ACM Control Requests

Command	Action
SEND_BREAK	Accepted but ignored (dummy)
SET_LINE_CODING	Accepted, value sent is readable in software
GET_LINE_CODING	By default, returns 9600 baud, no parity, 8 databits, 1 stopbit (Can be changed through software)
SET_CONTROL_LINE_STATE	Set the state of the RTS/DTR lines. See Table 31-2

Aside from general-purpose communication, the CDC-ACM interface can also be used to reset ESP32-C6 and optionally make it enter download mode to flash new firmware. This can be realized by setting the RTS and DTR lines on the virtual serial port.

Table 31-2. CDC-ACM Settings with RTS and DTR

RTS	DTR	Action
0	0	Clear download mode flag
0	1	Set download mode flag
1	0	Reset ESP32-C6
1	1	No action

Note that if the download mode flag is set when ESP32-C6 is reset, ESP32-C6 will reboot into download mode. When this flag is cleared and the chip is reset, ESP32-C6 will boot from flash. For specific sequences, please refer to Section 31.4. All these functions can also be disabled by programming various eFuses. Please refer to Chapter 6 *eFuse Controller* for more details.

31.3.2 CDC-ACM Firmware Interface Functional Description

The CPU can interact with the USB Serial/JTAG controller as the module is connected to the internal APB bus of ESP32-C6. This is mainly used to read and write data from and to the virtual serial port on the attached host.

USB CDC-ACM serial data is sent to and received from the host in packets of 0 to 64 bytes in size. When enough CDC-ACM data has accumulated in the host, the host sends a packet to the CDC-ACM receive endpoint, and the USB Serial/JTAG controller accepts this packet if it has a free buffer. Conversely, the host checks periodically if the USB Serial/JTAG controller has a packet ready to be sent to the host, and if so, receives this packet.

Firmware can get notified of new data from the host in one of the following two ways. First of all, the [USB_SERIAL_JTAG_SERIAL_OUT_EP_DATA_AVAIL](#) bit will remain set as long as there still is unread host data in the buffer. Secondly, the availability of data will trigger the [USB_SERIAL_JTAG_SERIAL_OUT_RECV_PKT_INT](#) interrupt. When data is available, it can be read by firmware through repeatedly reading bytes from [USB_SERIAL_JTAG_EP1_REG](#). The amount of bytes to read can be determined by checking the [USB_SERIAL_JTAG_SERIAL_OUT_EP_DATA_AVAIL](#) bit after reading each byte to see if there is more data to read. After all data is read, the USB debugging device is automatically readied to receive a new data packet from the host.

When the firmware has data to send, it can put the data in the send buffer and trigger a flush to allow the host to receive the data in a USB packet. In order to do so, there needs to be space available in the send buffer.

Firmware can check this by reading [USB_REG_SERIAL_IN_EP_DATA_FREE](#). A 1 in this register field indicates there is still free room in the buffer, and firmware can fill the buffer by writing bytes to the [USB_SERIAL_JTAG_EP1_REG](#) register. Writing the buffer does not immediately trigger sending data to the host until the buffer is flushed. After the flush, the entire buffer will be ready to be received by the USB host at once. A flush can be triggered in two ways: 1) after the 64th byte is written to the buffer, the USB hardware will automatically flush the buffer to the host; or 2) firmware can trigger a flush by writing 1 to [USB_REG_SERIAL_WR_DONE](#).

Regardless of how a flush is triggered, the send buffer will be unavailable for firmware to write into until it has been fully read by the host. As soon as the send buffer has been fully read, the [USB_SERIAL_JTAG_SERIAL_IN_EMPTY_INT](#) interrupt will be triggered, indicating that the send buffer can receive another 64 bytes.

It is possible to handle some out-of-band serial requests in software, specifically, the host setting DTR and RTS

and changing the line state. If the CDC-ACM interface receives a SET_LINE_CODING request, the peripheral can be configured to trigger a [USB_SERIAL_JTAG_SET_LINE_CODE_INT](#) interrupt, at which point the line coding can be read from the [USB_SERIAL_JTAG_SET_LINE_CODE_W0_REG](#) register. Similarly, SET_CONTROL_LINE_STATE requests will trigger [USB_SERIAL_JTAG_RTS_CHG_INT](#) and [USB_SERIAL_JTAG_DTR_CHG_INT](#) interrupts if they change the state of these lines. Software can then read the specific state through the [USB_SERIAL_JTAG_RTS](#) and [USB_SERIAL_JTAG_DTR](#) bits. Note that as described earlier, certain RTS/DTR sequences lead to hardware reset of ESP32-C6. Software can disable hardware recognition of these DTR/RTS sequences by setting the [USB_SERIAL_JTAG_USB_UART_CHIP_RST_DIS](#) bit, allowing software to interpret these signals freely.

Finally, the host can read the current line state using GET_LINE_CODING. This event sends back the data in the [USB_SERIAL_JTAG_GET_LINE_CODE_W0_REG](#) register and triggers a [USB_SERIAL_JTAG_GET_LINE_CODE_INT](#) interrupt.

31.3.3 USB-to-JTAG Interface: JTAG Command Processor

The USB-to-JTAG interface uses a vendor-specific class for its implementation. It consists of two endpoints, one to receive commands and another to send responses. Additionally, some less time-sensitive commands can be given as control requests.

Commands from the host to the JTAG interface are interpreted by the JTAG command processor. Internally, the JTAG command processor implements a full four-wire JTAG bus, consisting of the TCK, TMS and TDI output lines to the RISC-V CPU, as well as the TDO line signalling back from the CPU to the JTAG response capture unit. These signals adhere to the IEEE 1149.1 JTAG standards. Additionally, there is an SRST line to reset ESP32-C6.

Optionally, software can set [USB_SERIAL_JTAG_USB_JTAG_BRIDGE_EN](#) in order to redirect these signals to the GPIO matrix instead, where they can be routed to IO pads on ESP32-C6. This also allows external devices to be debugged via the USB Serial/JTAG peripheral.

The JTAG command processor parses each received nibble (4-bit value) as a command. As USB data is received in 8-bit bytes, this means each byte contains two commands. The USB command processor will execute high-nibble first and low-nibble second. The commands are used to control the TCK, TMS, TDI, and SRST lines of the internal JTAG bus, as well as to signal the JTAG response capture unit the state of the TDO line (which is driven by the CPU debugging logic) that needs to be captured.

In the internal JTAG bus, TCK, TMS, TDI, and TDO are connected directly to the JTAG debugging logic of the RISC-V CPU. SRST is connected to the reset logic of the digital circuitry in ESP32-C6 and a high level on this line will cause a digital system reset. Note that the USB Serial/JTAG controller itself is not affected by SRST.

A nibble can contain the following commands:

Table 31-3. Commands of a Nibble

bit	3	2	1	0
CMD_CLK	0	cap	tms	tdi
CMD_RST	1	0	0	srst
CMD_FLUSH	1	0	1	0
CMD_RSV	1	0	1	1
CMD_REP	1	1	R1	R0

- CMD_CLK will set the TDI and TMS as the indicated values and emit one clock pulse on TCK. If the CAP bit is 1, it will instruct the JTAG response capture unit to capture the state of the TDO line. This instruction forms the basis of JTAG communication.
- CMD_RST will set the state of the SRST line as the indicated value. This can be used to reset ESP32-C6.
- CMD_FLUSH will instruct the JTAG response capture unit to flush the buffer of all bits it collected so the host is able to read them. Note that in some cases, a JTAG transaction will end in an odd number of commands and as such an odd number of nibbles. In this case, it is allowed to repeat the CMD_FLUSH command to get an even number of nibbles fitting an integer number of bytes.
- CMD_RSV is reserved in the current implementation. This command will be ignored when received by ESP32-C6.
- CMD_REP repeats the last (non-CMD_REP) command for a certain number of times. The purpose is to compress command streams which repeat the CMD_CLK instruction for multiple times. A command such as CMD_CLK can be followed by multiple CMD_REP commands. The number of repetitions done by one CMD_REP can be expressed as $repetition_count = (R1 \times 2 + R0) \times (4^{cmd_rep_count})$, where *cmd_rep_count* indicates the number of the CMD_REP instruction that went directly before it. Note that the CMD_REP command is only intended to repeat a CMD_CLK command. Specifically, using it on a CMD_FLUSH command may lead to an unresponsive USB device, and a USB reset will be required to recover it.

31.3.4 USB-to-JTAG Interface: CMD_REP Usage Example

Here is a list of commands as an illustration of the usage of CMD_REP. Note that each command is a nibble, and in this example, the bitwise command stream would be 0x0D 0x5E 0xCF.

1. 0x0 (CMD_CLK: cap=0, tdi=0, tms=0)
2. 0xD (CMD_REP: R1=0, R0=1)
3. 0x5 (CMD_CLK: cap=1, tdi=0, tms=1)
4. 0xE (CMD_REP: R1=1, R0=0)
5. 0xC (CMD_REP: R1=0, R0=0)
6. 0xF (CMD_REP: R1=1, R0=1)

The following shows what happens at every step:

1. TCK is clocked with the TDI and TMS lines set to 0. No data is captured.
2. TCK is clocked another $(0 \times 2 + 1) \times (4^0) = 1$ time with the same settings as step 1.
3. TCK is clocked with the TDI line set to 0 and TMS set to 1. Data on the TDO line is captured.
4. TCK is clocked another $(1 \times 2 + 0) \times (4^0) = 2$ times with the same settings as step 3.
5. Nothing happens: $(0 \times 2 + 0) \times (4^1) = 0$. Note that this increases *cmd_rep_count* in the next step.
6. TCK is clocked another $(1 \times 2 + 1) \times (4^2) = 48$ times with the same settings as step 3.

In other words, this example stream has the same net effect as that of executing command 1 twice, then repeating command 3 for 51 times.

31.3.5 USB-to-JTAG Interface: Response Capture Unit

The response capture unit reads the TDO line of the internal JTAG bus and captures its value when the command parser executes a CMD_CLK with cap=1. It puts this bit into an internal shift register, and writes a byte into the USB buffer when 8 bits have been collected. Of these 8 bits, the least significant one is the one that is read from TDO the earliest.

As soon as either 64 bytes (512 bits) have been collected or a CMD_FLUSH command is executed, the response capture unit will make the buffer available for the host to receive. Note that the interface to the USB logic is double-buffered. Therefore, as long as the USB throughput is sufficient, the response capture unit can always receive more data. That is to say, while one of the buffers is waiting to be sent to the host, the other can receive more data. When the host has received data from its buffer and the response capture unit flushes its buffer, the two buffers exchange position.

This also means that a command stream can cause at most 128 bytes of capture data generated (less if there are flush commands in the stream) without the host acting to receive the generated data. If more data is generated anyway, the command stream will pause and the device will not accept more commands until the generated capture data is read out.

Note that in general, the logic of the response capture unit tries not to send zero-byte responses. For instance, sending a series of CMD_FLUSH commands will not cause a series of 0-byte USB responses to be sent. However, in the current implementation, some zero-0 responses may be generated in extraordinary circumstances. It is recommended to ignore these responses.

31.3.6 USB-to-JTAG Interface: Control Transfer Requests

Aside from the command processor and the response capture unit, the USB-to-JTAG interface also understands some control requests, as documented in the table below:

Table 31-4. USB-to-JTAG Control Requests

bmRequestType	bRequest	wValue	wIndex	wLength	Data
01000000b	0 (VEND_JTAG_SETDIV)	[divider]	interface	0	None
01000000b	1 (VEND_JTAG_SETIO)	[iobits]	interface	0	None
11000000b	2 (VEND_JTAG_GETTDO)	0	interface	1	[iostate]
10000000b	6 (GET_DESCRIPTOR)	0x2000	0	256	[jtag cap desc]

- VEND_JTAG_SETDIV sets the divider used. This directly affects the duration of a TCK clock pulse. The TCK clock pulses are derived from a base clock of 48 MHz, which is divided down using an internal divider. This control request allows the host to set this divider. Note that on startup, the divider is set to 2, which means the TCK clock rate will generally be 24 MHz.
- VEND_JTAG_SETIO can bypass the JTAG command processor to set the internal TDI, TDO, TMS, and SRST lines to given values. These values are encoded in the wValue field in the format of 11'b0, srst, trst, tck, tms, tdi.
- VEND_JTAG_GETTDO can bypass the JTAG response capture unit to read the internal TDO signal directly. This request returns one byte of data, of which the least significant bit represents the status of the TDO line.
- GET_DESCRIPTOR is a standard USB request. However, it can also be used with a vendor-specific wValue of 0x2000 to get the JTAG capabilities descriptor. This returns a certain amount of bytes representing the

following fixed structure, which describes the capabilities of the USB-to-JTAG adapter (as shown in Table 31-5). This structure allows host software to automatically support future revisions of the hardware without the need for an update.

The JTAG capability descriptors of ESP32-C6 are as follows. Note that all 16-bit values are little-endian.

Table 31-5. JTAG Capability Descriptors

Byte	Value	Description
0	1	JTAG protocol capability structure version
1	10	Total length of JTAG protocol capabilities
2	1	Type of this struct: 1 for speed capability struct
3	8	Length of this speed capabilities struct
4 ~ 5	4800	JTAG base clock speed in 10 kHz increments. Note that the maximum TCK speed is half of this value
6 ~ 7	1	Minimum divider value settable by the VEND_JTAG_SETDIV request
8 ~ 9	255	Maximum divider value settable by the VEND_JTAG_SETDIV request

31.4 Recommended Operation

Little setup is needed for using the USB Serial/JTAG device. The USB-to-JTAG hardware itself does not need any setup aside from the standard USB initialization that the host operating system already does. Apart from that, the CDC-ACM emulation on the host side is also plug-and-play.

On the firmware side, very little initialization is needed either. The USB hardware is self-initialized and after boot-up, if a host is connected and listening on the CDC-ACM interface, data can be exchanged as described above without any specific setup except for the situation when the firmware optionally sets up an interrupt service handler.

One thing to note is that there may be situations where either the host is not attached or the CDC-ACM virtual port is not opened. In such cases, the packets that are flushed to the host will never be picked up and the send buffer will never be empty. It is important to detect these situations and implement timeout, as this is the only way to reliably detect whether the port on the host side is closed or not.

Another thing to note is that the USB device is dependent on the BBPLL for the 48 MHz USB PHY clock. If this PLL is disabled, the USB communication will cease to function.

One scenario where this happens is Deep-sleep. The USB Serial/JTAG controller (as well as the attached RISC-V CPU) will be entirely powered down in Deep-sleep mode. If a device needs to be debugged in this mode, it may be preferable to use an external JTAG debugger and a serial interface instead.

The CDC-ACM interface can also be used to reset the SoC and take it into or out of download mode. Generating the correct sequence of handshake signals can be a bit complicated, since most operating systems only allow setting or resetting DTR and RTS separately, but not in tandem. Additionally, some drivers (e.g., the standard CDC-ACM driver on Windows) do not set DTR until RTS is set and the user needs to explicitly set RTS in order to 'propagate' the DTR value. The recommended procedures are introduced below.

To reset the SoC into download mode:

Table 31-6. Reset SoC into Download Mode

Action	Internal state	Note
Clear DTR	RTS=?, DTR=0	Initialize to known values
Clear RTS	RTS=0, DTR=0	-
Set DTR	RTS=0, DTR=1	Set download mode flag
Clear RTS	RTS=0, DTR=1	Propagate DTR
Set RTS	RTS=1, DTR=1	-
Clear DTR	RTS=1, DTR=0	Reset SoC
Set RTS	RTS=1, DTR=0	Propagate DTR
Clear RTS	RTS=0, DTR=0	Clear download flag

To reset the SoC into booting from flash:

Table 31-7. Reset SoC into Booting from flash

Action	Internal state	Note
Clear DTR	RTS=?, DTR=0	-
Clear RTS	RTS=0, DTR=0	Clear download flag
Set RTS	RTS=1, DTR=0	Reset SoC
Clear RTS	RTS=0, DTR=0	Exit reset

31.5 Interrupts

- USB_SERIAL_JTAG_JTAG_IN_FLUSH_INT: triggered when flush cmd is received for IN endpoint 2 of JTAG.
- USB_SERIAL_JTAG_SOF_INT: triggered when SOF frame is received.
- USB_SERIAL_JTAG_SERIAL_OUT_RECV_PKT_INT: triggered when Serial Port OUT Endpoint receives one packet.
- USB_SERIAL_JTAG_SERIAL_IN_EMPTY_INT: triggered when Serial Port IN Endpoint is empty.
- USB_SERIAL_JTAG_PID_ERR_INT: triggered when PID error is detected.
- USB_SERIAL_JTAG_CRC5_ERR_INT: triggered when CRC5 error is detected.
- USB_SERIAL_JTAG_CRC16_ERR_INT: triggered when CRC16 error is detected.
- USB_SERIAL_JTAG_STUFF_ERR_INT: triggered when a bit stuffing error is detected.
- USB_SERIAL_JTAG_IN_TOKEN_REC_IN_EP1_INT: triggered when IN token for IN endpoint 1 is received.
- USB_SERIAL_JTAG_USB_BUS_RESET_INT: triggered when USB bus reset is detected.
- USB_SERIAL_JTAG_OUT_EP1_ZERO_PAYLOAD_INT: triggered when OUT endpoint 1 receives packet with zero payload.
- USB_SERIAL_JTAG_OUT_EP2_ZERO_PAYLOAD_INT: triggered when OUT endpoint 2 receives packet with zero payload.
- USB_SERIAL_JTAG_RTS_CHG_INT: triggered when level of RTS from USB serial channel is changed.
- USB_SERIAL_JTAG_DTR_CHG_INT: triggered when level of DTR from USB serial channel is changed.

- USB_SERIAL_JTAG_GET_LINE_CODE_INT: triggered when level of GET LINE CODING request is received.
- USB_SERIAL_JTAG_SET_LINE_CODE_INT: triggered when level of SET LINE CODING request is received.

31.6 Register Summary

The addresses in this section are relative to USB Serial/JTAG controller base address provided in Table 5-2 in Chapter 5 *System and Memory*.

The abbreviations given in Column **Access** are explained in Section *Access Types for Registers*.

Name	Description	Address	Access
Configuration Registers			
USB_SERIAL_JTAG_EP1_REG	FIFO access for the CDC-ACM data IN and OUT endpoints	0x0000	R/W
USB_SERIAL_JTAG_EP1_CONF_REG	Configuration and control registers for the CDC-ACM FIFOs	0x0004	varies
USB_SERIAL_JTAG_CONF0_REG	PHY hardware configuration	0x0018	R/W
USB_SERIAL_JTAG_TEST_REG	Registers used for debugging the PHY	0x001C	varies
USB_SERIAL_JTAG_MISC_CONF_REG	Clock enable control	0x0044	R/W
USB_SERIAL_JTAG_MEM_CONF_REG	Memory power control	0x0048	R/W
USB_SERIAL_JTAG_CHIP_RST_REG	CDC-ACM chip reset control	0x004C	varies
USB_SERIAL_JTAG_GET_LINE_CODE_W0_REG	W0 of GET_LINE_CODING command	0x0058	R/W
USB_SERIAL_JTAG_GET_LINE_CODE_W1_REG	W1 of GET_LINE_CODING command	0x005C	R/W
USB_SERIAL_JTAG_CONFIG_UPDATE_REG	Configuration registers' value update	0x0060	WT
USB_SERIAL_JTAG_SER_AFIFO_CONFIG_REG	Serial AFIFO configure register	0x0064	varies
Interrupt Registers			
USB_SERIAL_JTAG_INT_RAW_REG	Interrupt raw status register	0x0008	R/WTC/SS
USB_SERIAL_JTAG_INT_ST_REG	Interrupt status register	0x000C	RO
USB_SERIAL_JTAG_INT_ENA_REG	Interrupt enable status register	0x0010	R/W
USB_SERIAL_JTAG_INT_CLR_REG	Interrupt clear status register	0x0014	WT
Status Registers			
USB_SERIAL_JTAG_JFIFO_ST_REG	JTAG FIFO status and control registers	0x0020	varies
USB_SERIAL_JTAG_FRAM_NUM_REG	Last received SOF frame index register	0x0024	RO
USB_SERIAL_JTAG_IN_EP0_ST_REG	Control IN endpoint status information	0x0028	RO
USB_SERIAL_JTAG_IN_EP1_ST_REG	CDC-ACM IN endpoint status information	0x002C	RO
USB_SERIAL_JTAG_IN_EP2_ST_REG	CDC-ACM interrupt IN endpoint status information	0x0030	RO
USB_SERIAL_JTAG_IN_EP3_ST_REG	JTAG IN endpoint status information	0x0034	RO
USB_SERIAL_JTAG_OUT_EP0_ST_REG	Control OUT endpoint status information	0x0038	RO
USB_SERIAL_JTAG_OUT_EP1_ST_REG	CDC-ACM OUT endpoint status information	0x003C	RO
USB_SERIAL_JTAG_OUT_EP2_ST_REG	JTAG OUT endpoint status information	0x0040	RO
USB_SERIAL_JTAG_SET_LINE_CODE_W0_REG	W0 of SET_LINE_CODING command	0x0050	RO
USB_SERIAL_JTAG_SET_LINE_CODE_W1_REG	W1 of SET_LINE_CODING command	0x0054	RO
USB_SERIAL_JTAG_BUS_RESET_ST_REG	USB Bus reset status register	0x0068	RO
Version Registers			

Name	Description	Address	Access
USB_SERIAL_JTAG_DATE_REG	Date register	0x0080	R/W

31.7 Registers

The addresses in this section are relative to USB Serial/JTAG controller base address provided in Table 5-2 in Chapter 5 *System and Memory*.

Register 31.1. USB_SERIAL_JTAG_EP1_REG (0x0000)

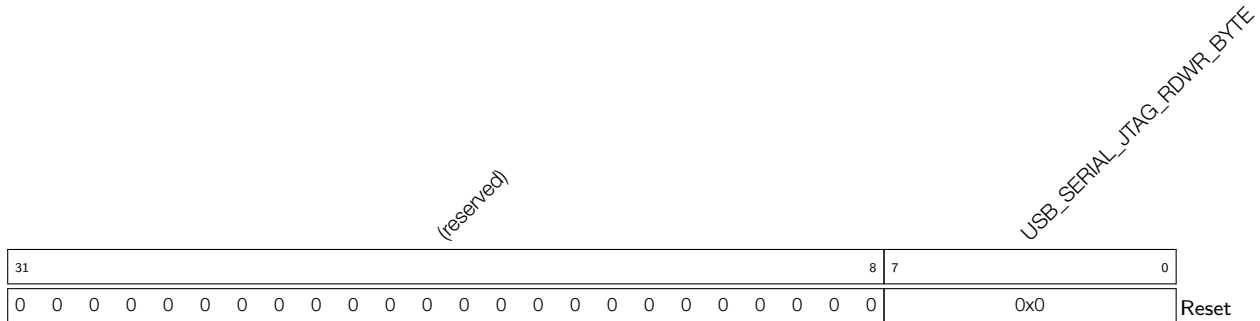

USB_SERIAL_JTAG_RDWR_BYTE Write or read byte data to or from UART TX/RX FIFO.

When [USB_SERIAL_JTAG_SERIAL_IN_EMPTY_INT](#) is set, users can write data (up to 64 bytes) into UART TX FIFO through this register.

When [USB_SERIAL_JTAG_SERIAL_OUT_RECV_PKT_INT](#) is set, users can check how many data is received through [USB_SERIAL_JTAG_OUT_EP1_WR_ADDR](#), then read data from UART RX FIFO through this register.

(R/W)

Register 31.2. USB_SERIAL_JTAG_EP1_CONF_REG (0x0004)

(reserved)																USB_SERIAL_JTAG_SERIAL_OUT_EP_DATA_AVAIL USB_SERIAL_JTAG_SERIAL_IN_EP_DATA_FREE USB_SERIAL_JTAG_WR_DONE				
31																3	2	1	0	Reset
0																0	1	0		

USB_SERIAL_JTAG_WR_DONE Configures whether to represent writing byte data to UART TX FIFO is done.

0: No effect

1: Represents writing byte data to UART TX FIFO is done

This bit then stays 0 until data in UART TX FIFO is read by the USB Host.

(WT)

USB_SERIAL_JTAG_SERIAL_IN_EP_DATA_FREE Represents whether UART TX FIFO has space available.

0: UART TX FIFO is full and no data should be written into it

1: UART TX FIFO is not full and data can be written into it

After writing USB_SERIAL_JTAG_WR_DONE, this bit will be 0 until data in UART TX FIFO is read by USB Host.

(RO)

USB_SERIAL_JTAG_SERIAL_OUT_EP_DATA_AVAIL Represents whether there is data in UART RX FIFO.

0: There is no data in UART RX FIFO

1: There is data in UART RX FIFO

(RO)

Register 31.3. USB_SERIAL_JTAG_CONF0_REG (0x0018)

(reserved)																USB_SERIAL_JTAG_USB_JTAG_BRIDGE_EN USB_SERIAL_JTAG_USB_PAD_ENABLE USB_SERIAL_JTAG_PULLUP_VALUE USB_SERIAL_JTAG_DM_PULLDOWN USB_SERIAL_JTAG_DP_PULLDOWN USB_SERIAL_JTAG_DM_PULLUP USB_SERIAL_JTAG_DP_PULLUP USB_SERIAL_JTAG_VREF_OVERRIDE USB_SERIAL_JTAG_VREFL USB_SERIAL_JTAG_VREFH USB_SERIAL_JTAG_EXCHG_PINS_OVERRIDE USB_SERIAL_JTAG_PHY_SEL																	
31																16	15	14	13	12	11	10	9	8	7	6	5	4	3	2	1	0	Reset
0	0	0	0	0	0	0	0	0	0	0	0	0	0	0	0	0	0	0	0	0	0	0	0	0	0	0	0						

USB_SERIAL_JTAG_PHY_SEL Configures whether to select internal or external PHY.

- 0: Internal PHY
 - 1: External PHY
- (R/W)

USB_SERIAL_JTAG_EXCHG_PINS_OVERRIDE Configures whether to enable software control USB D+ D- exchange.

- 0: Disable
 - 1: Enable
- (R/W)

USB_SERIAL_JTAG_EXCHG_PINS Configures whether to enable USB D+ D- exchange.

- 0: Disable
 - 1: Enable
- (R/W)

USB_SERIAL_JTAG_VREFH Configures single-end input high threshold.

- 0: 1.76 V
 - 1: 1.84 V
 - 2: 1.92 V
 - 3: 2.00 V
- (R/W)

USB_SERIAL_JTAG_VREFL Configures single-end input low threshold.

- 0: 0.80 V
 - 1: 0.88 V
 - 2: 0.96 V
 - 3: 1.04 V
- (R/W)

USB_SERIAL_JTAG_VREF_OVERRIDE Configures whether to enable software control input threshold.

- 0: Disable
 - 1: Enable
- (R/W)

Continued on the next page...

Register 31.3. USB_SERIAL_JTAG_CONF0_REG (0x0018)

Continued from the previous page...

USB_SERIAL_JTAG_PAD_PULL_OVERRIDE Configures whether to enable software to control USB D+ D- pullup and pulldown.
0: Disable
1: Enable
(R/W)

USB_SERIAL_JTAG_DP_PULLUP Configures whether to enable USB D+ pull up when USB_SERIAL_JTAG_PAD_PULL_OVERRIDE is 1.
0: Disable
1: Enable
(R/W)

USB_SERIAL_JTAG_DP_PULLDOWN Configures whether to enable USB D+ pull down when USB_SERIAL_JTAG_PAD_PULL_OVERRIDE is 1.
0: Disable
1: Enable
(R/W)

USB_SERIAL_JTAG_DM_PULLDOWN Configures whether to enable USB D- pull down when USB_SERIAL_JTAG_PAD_PULL_OVERRIDE is 1.
0: Disable
1: Enable
(R/W)

USB_SERIAL_JTAG_PULLUP_VALUE Configures the pull up value when USB_SERIAL_JTAG_PAD_PULL_OVERRIDE is 1.
0: 2.2 K
1: 1.1 K
(R/W)

USB_SERIAL_JTAG_USB_PAD_ENABLE Configures whether to enable USB pad function.
0: Disable
1: Enable
(R/W)

USB_SERIAL_JTAG_USB_JTAG_BRIDGE_EN Configures whether to disconnect usb_jtag and internal JTAG.
0: usb_jtag is connected to the internal JTAG port of CPU
1: usb_jtag and the internal JTAG are disconnected, MTMS, MTDI, and MTCK are output through GPIO Matrix, and MTDO is input through GPIO Matrix
(R/W)

Register 31.4. USB_SERIAL_JTAG_TEST_REG (0x001C)

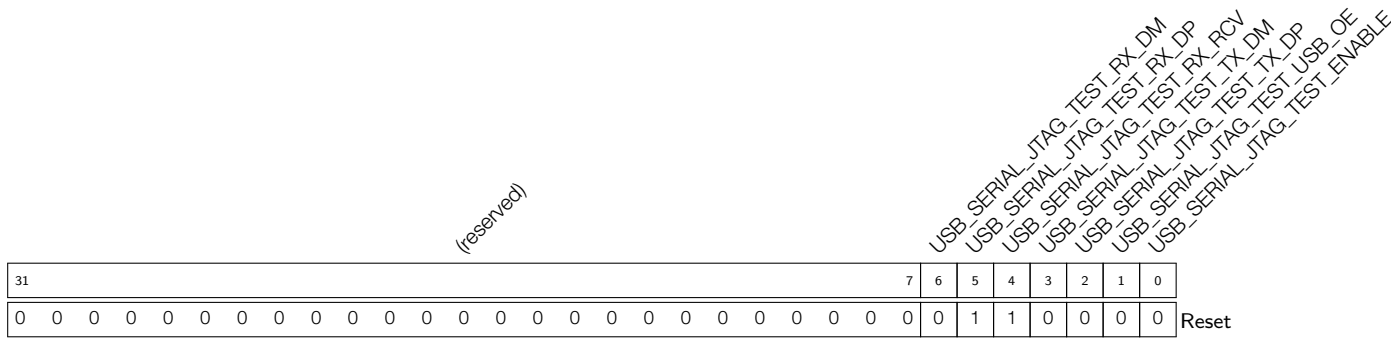

USB_SERIAL_JTAG_TEST_ENABLE Configures whether to enable the test mode of the USB pad.

- 0: Resume normal operation
- 1: Enable the test mode of the USB pad

Enabling the test mode of the USB pad allows the USB pad to be controlled/read using the other bits in this register.

(R/W)

USB_SERIAL_JTAG_TEST_USB_OE Configures whether to enable USB pad output.

- 0: Set D+ and D- to high impedance
- 1: Output the values set in USB_SERIAL_JTAG_TEST_TX_DP and USB_SERIAL_JTAG_TEST_TX_DM on the D+ and D- pins

(R/W)

USB_SERIAL_JTAG_TEST_TX_DP Configures value of USB D+ in test mode when USB_SERIAL_JTAG_TEST_USB_OE is 1. (R/W)

USB_SERIAL_JTAG_TEST_TX_DM Configures value of USB D- in test mode when USB_SERIAL_JTAG_TEST_USB_OE is 1. (R/W)

USB_SERIAL_JTAG_TEST_RX_RCV Represents the current logical level of the voltage difference between USB D- and USB D+ pads in test mode.

- 0: USB D- voltage is higher than USB D+
- 1: USB D+ voltage is higher than USB D-

(RO)

USB_SERIAL_JTAG_TEST_RX_DP Represents the logical level of the USB D+ pad in test mode. (RO)

USB_SERIAL_JTAG_TEST_RX_DM Represents the logical level of the USB D- pad in test mode. (RO)

Register 31.5. USB_SERIAL_JTAG_MISC_CONF_REG (0x0044)

(reserved)	USB_SERIAL_JTAG_CLK_EN
31	1 0
0 0	Reset

USB_SERIAL_JTAG_CLK_EN Configures whether to force clock on for register.

0: Support clock only when application writes registers

1: Force clock on for register

(R/W)

Register 31.6. USB_SERIAL_JTAG_MEM_CONF_REG (0x0048)

(reserved)	USB_SERIAL_JTAG_USB_MEM_CLK_EN	USB_SERIAL_JTAG_USB_MEM_PD
31	2 1 0	1 0
0 0	Reset	0

USB_SERIAL_JTAG_USB_MEM_PD Configures whether to power down USB memory.

0: No effect

1: Power down

(R/W)

USB_SERIAL_JTAG_USB_MEM_CLK_EN Configures whether to force clock on for USB memory.

0: No effect

1: Force

(R/W)

Register 31.7. USB_SERIAL_JTAG_CHIP_RST_REG (0x004C)

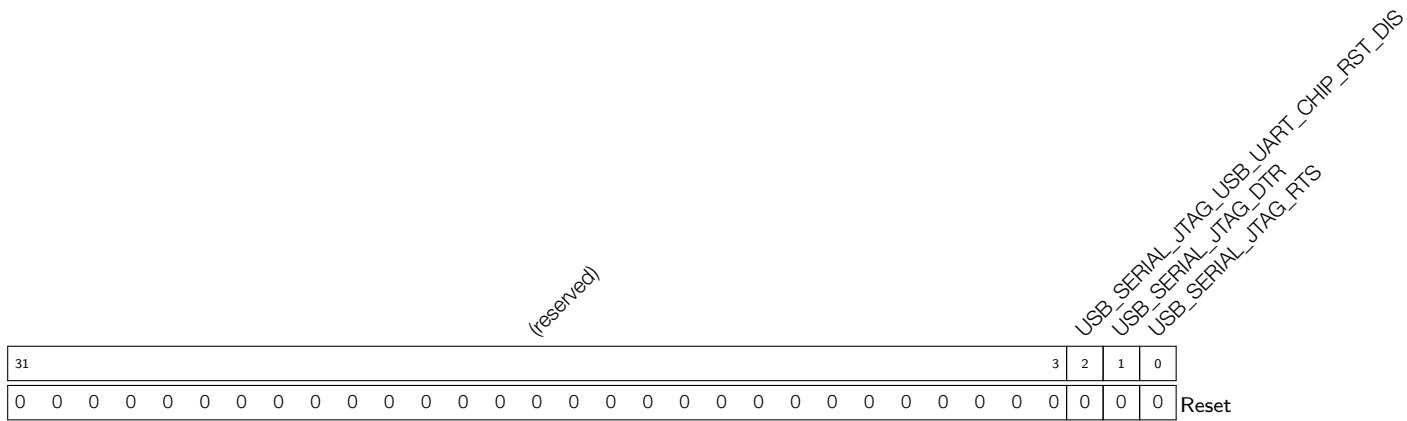

USB_SERIAL_JTAG_RTSS Represents the state of RTS signal as set by the most recent SET_LINE_CODING command. (RO)

USB_SERIAL_JTAG_DTR Represents the state of DTR signal as set by the most recent SET_LINE_CODING command. (RO)

USB_SERIAL_JTAG_USB_UART_CHIP_RST_DIS Configures whether to disable chip reset from USB serial channel.
 0: No effect
 1: Disable
 (R/W)

Register 31.8. USB_SERIAL_JTAG_GET_LINE_CODE_W0_REG (0x0058)

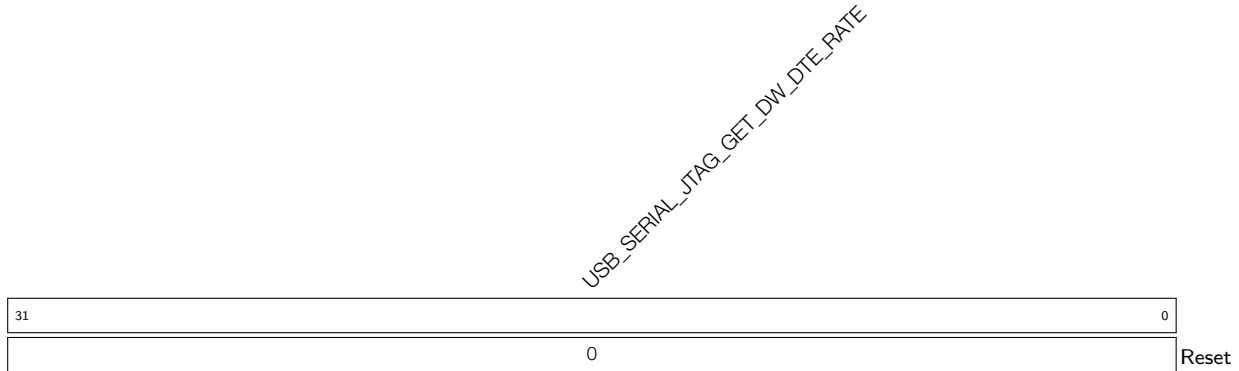

USB_SERIAL_JTAG_GET_DW_DTE_RATE Configures the value of dwDTERate set by software, which is requested by GET_LINE_CODING command. (R/W)

Register 31.9. USB_SERIAL_JTAG_GET_LINE_CODE_W1_REG (0x005C)

(reserved)								<i>USB_SERIAL_JTAG_GET_BCHAR_FORMAT</i>								<i>USB_SERIAL_JTAG_GET_BPARITY_TYPE</i>								<i>USB_SERIAL_JTAG_GET_BDATA_BITS</i>								
31								24	23							16	15			8	7			0								
0 0 0 0 0 0 0 0								0								0								0								Reset

USB_SERIAL_JTAG_GET_BDATA_BITS Configures the value of bDataBits set by software, which is requested by GET_LINE_CODING command. (R/W)

USB_SERIAL_JTAG_GET_BPARITY_TYPE Configures the value of bParityType set by software, which is requested by GET_LINE_CODING command. (R/W)

USB_SERIAL_JTAG_GET_BCHAR_FORMAT Configures the value of bCharFormat set by software, which is requested by GET_LINE_CODING command. (R/W)

Register 31.10. USB_SERIAL_JTAG_CONFIG_UPDATE_REG (0x0060)

(reserved)																															<i>USB_SERIAL_JTAG_CONFIG_UPDATE</i>
31																														1	0
0 0																															Reset

USB_SERIAL_JTAG_CONFIG_UPDATE Configures whether to update the value of configuration registers from APB clock domain to 48 MHz clock domain.
 0: No effect
 1: Update
 (WT)

Register 31.12. USB_SERIAL_JTAG_INT_RAW_REG (0x0008)

31	(reserved)																16	15	14	13	12	11	10	9	8	7	6	5	4	3	2	1	0
0	0	0	0	0	0	0	0	0	0	0	0	0	0	0	0	0	0	0	0	0	0	0	0	1	0	0	0	0	Reset				

USB_SERIAL_JTAG_JTAG_IN_FLUSH_INT_RAW The raw interrupt status of [USB_SERIAL_JTAG_JTAG_IN_FLUSH_INT](#). (R/WTC/SS)

USB_SERIAL_JTAG_SOF_INT_RAW The raw interrupt status of [USB_SERIAL_JTAG_SOF_INT](#). (R/WTC/SS)

USB_SERIAL_JTAG_SERIAL_OUT_RECV_PKT_INT_RAW The raw interrupt status of [USB_SERIAL_JTAG_SERIAL_OUT_RECV_PKT_INT](#). (R/WTC/SS)

USB_SERIAL_JTAG_SERIAL_IN_EMPTY_INT_RAW The raw interrupt status of [USB_SERIAL_JTAG_SERIAL_IN_EMPTY_INT](#). (R/WTC/SS)

USB_SERIAL_JTAG_PID_ERR_INT_RAW The raw interrupt status of [USB_SERIAL_JTAG_PID_ERR_INT](#). (R/WTC/SS)

USB_SERIAL_JTAG_CRC5_ERR_INT_RAW The raw interrupt status of [USB_SERIAL_JTAG_CRC5_ERR_INT](#). (R/WTC/SS)

USB_SERIAL_JTAG_CRC16_ERR_INT_RAW The raw interrupt status of [USB_SERIAL_JTAG_CRC16_ERR_INT](#). (R/WTC/SS)

USB_SERIAL_JTAG_STUFF_ERR_INT_RAW The raw interrupt status of [USB_SERIAL_JTAG_STUFF_ERR_INT](#). (R/WTC/SS)

USB_SERIAL_JTAG_IN_TOKEN_REC_IN_EP1_INT_RAW The raw interrupt status of [USB_SERIAL_JTAG_IN_TOKEN_REC_IN_EP1_INT](#). (R/WTC/SS)

USB_SERIAL_JTAG_USB_BUS_RESET_INT_RAW The raw interrupt status of [USB_SERIAL_JTAG_USB_BUS_RESET_INT](#). (R/WTC/SS)

USB_SERIAL_JTAG_OUT_EP1_ZERO_PAYLOAD_INT_RAW The raw interrupt status of [USB_SERIAL_JTAG_OUT_EP1_ZERO_PAYLOAD_INT](#). (R/WTC/SS)

Continued on the next page...

Register 31.12. USB_SERIAL_JTAG_INT_RAW_REG (0x0008)

Continued from the previous page...

USB_SERIAL_JTAG_OUT_EP2_ZERO_PAYLOAD_INT_RAW The raw interrupt status of [USB_SERIAL_JTAG_OUT_EP2_ZERO_PAYLOAD_INT](#). (R/WTC/SS)

USB_SERIAL_JTAG_RTS_CHG_INT_RAW The raw interrupt status of [USB_SERIAL_JTAG_RTS_CHG_INT](#). (R/WTC/SS)

USB_SERIAL_JTAG_DTR_CHG_INT_RAW The raw interrupt status of [USB_SERIAL_JTAG_DTR_CHG_INT](#). (R/WTC/SS)

USB_SERIAL_JTAG_GET_LINE_CODE_INT_RAW The raw interrupt status of [USB_SERIAL_JTAG_GET_LINE_CODE_INT](#). (R/WTC/SS)

USB_SERIAL_JTAG_SET_LINE_CODE_INT_RAW The raw interrupt status of [USB_SERIAL_JTAG_SET_LINE_CODE_INT](#). (R/WTC/SS)

Register 31.13. USB_SERIAL_JTAG_INT_ST_REG (0x000C)

<i>(reserved)</i>																USB_SERIAL_JTAG_SET_LINE_CODE_INT_ST USB_SERIAL_JTAG_GET_LINE_CODE_INT_ST USB_SERIAL_JTAG_DTR_CHG_INT_ST USB_SERIAL_JTAG_OUT_EP1_INT_ST USB_SERIAL_JTAG_OUT_EP2_INT_ST USB_SERIAL_JTAG_ZERO_PAYLOAD_INT_ST USB_SERIAL_JTAG_USB_BUS_RESET_INT_ST USB_SERIAL_JTAG_TOKEN_REC_IN_EP1_INT_ST USB_SERIAL_JTAG_STUFF_ERR_INT_ST USB_SERIAL_JTAG_CRC16_ERR_INT_ST USB_SERIAL_JTAG_CRC5_ERR_INT_ST USB_SERIAL_JTAG_SERIAL_IN_EMPTY_INT_ST USB_SERIAL_JTAG_SERIAL_OUT_RECV_PKT_INT_ST																	
31	16	15	14	13	12	11	10	9	8	7	6	5	4	3	2	1	0																
0																0																Reset	

USB_SERIAL_JTAG_JTAG_IN_FLUSH_INT_ST The masked interrupt status of [USB_SERIAL_JTAG_JTAG_IN_FLUSH_INT](#). (RO)

USB_SERIAL_JTAG_SOF_INT_ST The masked interrupt status of [USB_SERIAL_JTAG_SOF_INT](#). (RO)

USB_SERIAL_JTAG_SERIAL_OUT_RECV_PKT_INT_ST The masked interrupt status of the [USB_SERIAL_JTAG_SERIAL_OUT_RECV_PKT_INT](#). (RO)

USB_SERIAL_JTAG_SERIAL_IN_EMPTY_INT_ST The masked interrupt status of [USB_SERIAL_JTAG_SERIAL_IN_EMPTY_INT](#). (RO)

USB_SERIAL_JTAG_PID_ERR_INT_ST The masked interrupt status of [USB_SERIAL_JTAG_PID_ERR_INT](#). (RO)

USB_SERIAL_JTAG_CRC5_ERR_INT_ST The masked interrupt status of [USB_SERIAL_JTAG_CRC5_ERR_INT](#). (RO)

USB_SERIAL_JTAG_CRC16_ERR_INT_ST The masked interrupt status of [USB_SERIAL_JTAG_CRC16_ERR_INT](#). (RO)

USB_SERIAL_JTAG_STUFF_ERR_INT_ST The masked interrupt status of [USB_SERIAL_JTAG_STUFF_ERR_INT](#). (RO)

USB_SERIAL_JTAG_IN_TOKEN_REC_IN_EP1_INT_ST The masked interrupt status of [USB_SERIAL_JTAG_IN_TOKEN_REC_IN_EP1_INT](#). (RO)

USB_SERIAL_JTAG_USB_BUS_RESET_INT_ST The masked interrupt status of [USB_SERIAL_JTAG_USB_BUS_RESET_INT](#). (RO)

USB_SERIAL_JTAG_OUT_EP1_ZERO_PAYLOAD_INT_ST The masked interrupt status of [USB_SERIAL_JTAG_OUT_EP1_ZERO_PAYLOAD_INT](#) (RO)

USB_SERIAL_JTAG_OUT_EP2_ZERO_PAYLOAD_INT_ST The masked interrupt status of [USB_SERIAL_JTAG_OUT_EP2_ZERO_PAYLOAD_INT](#). (RO)

Continued on the next page...

Register 31.13. USB_SERIAL_JTAG_INT_ST_REG (0x000C)

Continued from the previous page...

USB_SERIAL_JTAG_RTS_CHG_INT_ST	The	masked	interrupt	status	of
USB_SERIAL_JTAG_RTS_CHG_INT . (RO)					
USB_SERIAL_JTAG_DTR_CHG_INT_ST	The	masked	interrupt	status	of
USB_SERIAL_JTAG_DTR_CHG_INT . (RO)					
USB_SERIAL_JTAG_GET_LINE_CODE_INT_ST	The	masked	interrupt	status	of
USB_SERIAL_JTAG_GET_LINE_CODE_INT . (RO)					
USB_SERIAL_JTAG_SET_LINE_CODE_INT_ST	The	masked	interrupt	status	of
USB_SERIAL_JTAG_SET_LINE_CODE_INT . (RO)					

Register 31.14. USB_SERIAL_JTAG_INT_ENA_REG (0x0010)

Continued from the previous page...

USB_SERIAL_JTAG_RTS_CHG_INT_ENA Write 1 to enable [USB_SERIAL_JTAG_RTS_CHG_INT](#).
(R/W)

USB_SERIAL_JTAG_DTR_CHG_INT_ENA Write 1 to enable [USB_SERIAL_JTAG_DTR_CHG_INT](#).
(R/W)

USB_SERIAL_JTAG_GET_LINE_CODE_INT_ENA Write 1 to enable
[USB_SERIAL_JTAG_GET_LINE_CODE_INT](#). (R/W)

USB_SERIAL_JTAG_SET_LINE_CODE_INT_ENA Write 1 to enable
[USB_SERIAL_JTAG_SET_LINE_CODE_INT](#). (R/W)

Register 31.15. USB_SERIAL_JTAG_INT_CLR_REG (0x0014)

Continued from the previous page...

USB_SERIAL_JTAG_RTS_CHG_INT_CLR Write 1 to clear [USB_SERIAL_JTAG_RTS_CHG_INT](#).
(WT)

USB_SERIAL_JTAG_DTR_CHG_INT_CLR Write 1 to clear [USB_SERIAL_JTAG_DTR_CHG_INT](#).
(WT)

USB_SERIAL_JTAG_GET_LINE_CODE_INT_CLR Write 1 to clear
[USB_SERIAL_JTAG_GET_LINE_CODE_INT](#). (WT)

USB_SERIAL_JTAG_SET_LINE_CODE_INT_CLR Write 1 to clear
[USB_SERIAL_JTAG_SET_LINE_CODE_INT](#). (WT)

Register 31.16. USB_SERIAL_JTAG_JFIFO_ST_REG (0x0020)

(reserved)										USB_SERIAL_JTAG_OUT_FIFO_RESET USB_SERIAL_JTAG_IN_FIFO_RESET USB_SERIAL_JTAG_OUT_FIFO_FULL USB_SERIAL_JTAG_OUT_FIFO_EMPTY USB_SERIAL_JTAG_IN_FIFO_FULL USB_SERIAL_JTAG_IN_FIFO_EMPTY																		
31											10	9	8	7	6	5	4	3	2	1	0							
0										0										0	0	0	1	0	0	1	0	Reset

USB_SERIAL_JTAG_IN_FIFO_CNT Represents JTAG IN FIFO counter. (RO)

USB_SERIAL_JTAG_IN_FIFO_EMPTY Represents whether JTAG IN FIFO is empty.

0: Not empty

1: Empty

(RO)

USB_SERIAL_JTAG_IN_FIFO_FULL Represents whether JTAG IN FIFO is full.

0: Not full

1: Full

(RO)

USB_SERIAL_JTAG_OUT_FIFO_CNT Represents JTAG OUT FIFO counter. (RO)

USB_SERIAL_JTAG_OUT_FIFO_EMPTY Represents whether JTAG OUT FIFO is empty.

0: Not empty

1: Empty

(RO)

USB_SERIAL_JTAG_OUT_FIFO_FULL Represents whether JTAG OUT FIFO is full.

0: Not full

1: Full

(RO)

USB_SERIAL_JTAG_IN_FIFO_RESET Configures whether to reset JTAG IN FIFO.

0: No effect

1: Reset

(R/W)

USB_SERIAL_JTAG_OUT_FIFO_RESET Configures whether to reset JTAG OUT FIFO.

0: No effect

1: Reset

(R/W)

Register 31.19. USB_SERIAL_JTAG_IN_EP1_ST_REG (0x002C)

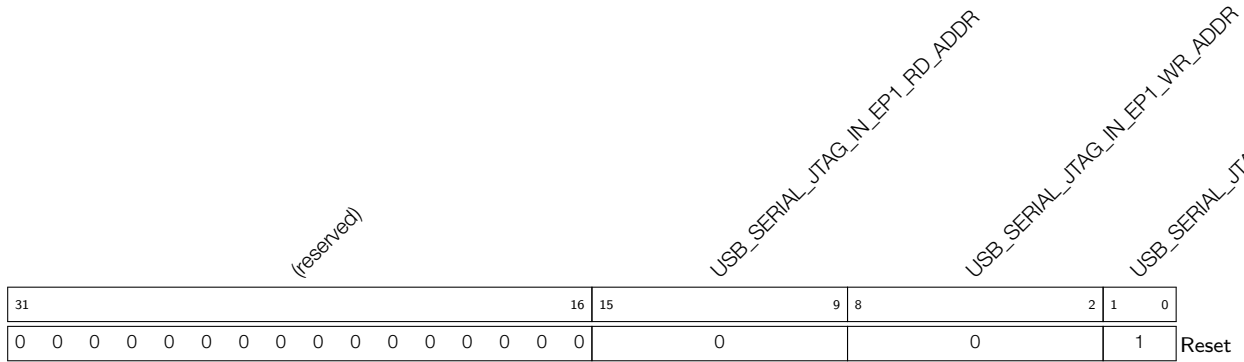

USB_SERIAL_JTAG_IN_EP1_STATE Represents state of IN Endpoint 1. (RO)

USB_SERIAL_JTAG_IN_EP1_WR_ADDR Represents write data address of IN endpoint 1. (RO)

USB_SERIAL_JTAG_IN_EP1_RD_ADDR Represents read data address of IN endpoint 1. (RO)

Register 31.20. USB_SERIAL_JTAG_IN_EP2_ST_REG (0x0030)

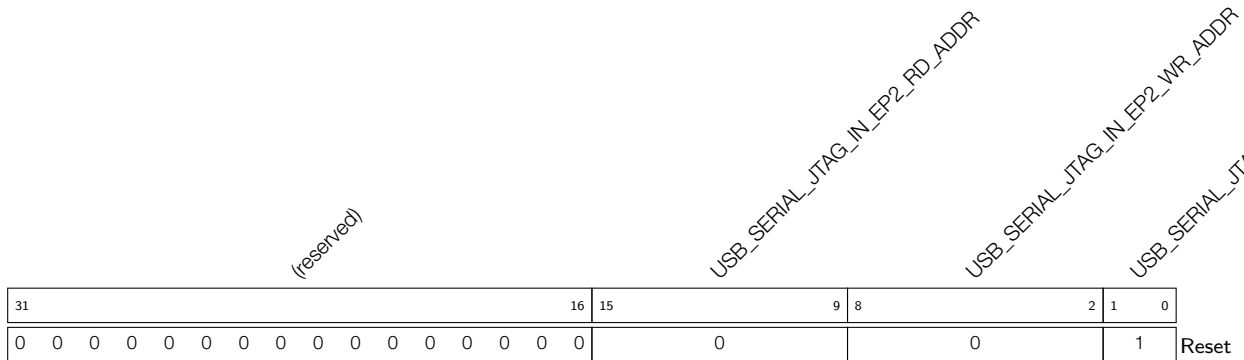

USB_SERIAL_JTAG_IN_EP2_STATE Represents state of IN Endpoint 2. (RO)

USB_SERIAL_JTAG_IN_EP2_WR_ADDR Represents write data address of IN endpoint 2. (RO)

USB_SERIAL_JTAG_IN_EP2_RD_ADDR Represents read data address of IN endpoint 2. (RO)

Register 31.21. USB_SERIAL_JTAG_IN_EP3_ST_REG (0x0034)

(reserved)																USB_SERIAL_JTAG_IN_EP3_RD_ADDR								USB_SERIAL_JTAG_IN_EP3_WR_ADDR								USB_SERIAL_JTAG_IN_EP3_STATE								
31																16	15								9	8							2	1	0					
0																0								0								1								Reset

USB_SERIAL_JTAG_IN_EP3_STATE Represents state of IN Endpoint 3. (RO)

USB_SERIAL_JTAG_IN_EP3_WR_ADDR Represents write data address of IN endpoint 3. (RO)

USB_SERIAL_JTAG_IN_EP3_RD_ADDR Represents read data address of IN endpoint 3. (RO)

Register 31.22. USB_SERIAL_JTAG_OUT_EP0_ST_REG (0x0038)

(reserved)																USB_SERIAL_JTAG_OUT_EP0_RD_ADDR								USB_SERIAL_JTAG_OUT_EP0_WR_ADDR								USB_SERIAL_JTAG_OUT_EP0_STATE								
31																16	15								9	8							2	1	0					
0																0								0								0								Reset

USB_SERIAL_JTAG_OUT_EP0_STATE Represents state of OUT Endpoint 0. (RO)

USB_SERIAL_JTAG_OUT_EP0_WR_ADDR Represents write data address of OUT endpoint 0.

When [USB_SERIAL_JTAG_SERIAL_OUT_RECV_PKT_INT](#) is detected, there are (USB_SERIAL_JTAG_OUT_EP0_WR_ADDR – 2) bytes data in OUT endpoint 0.

(RO)

USB_SERIAL_JTAG_OUT_EP0_RD_ADDR Represents read data address of OUT endpoint 0. (RO)

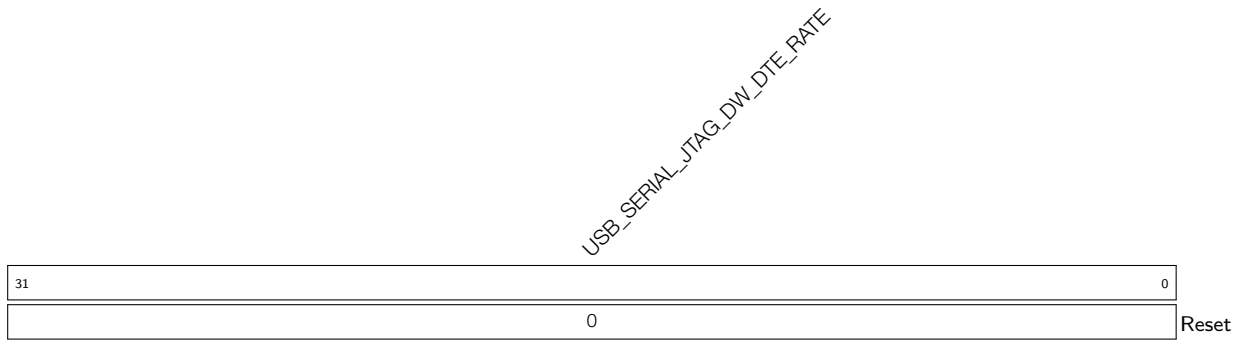
Register 31.25. USB_SERIAL_JTAG_SET_LINE_CODE_W0_REG (0x0050)

USB_SERIAL_JTAG_DW_DTE_RATE Represents the value of dwDTERate set by host through SET_LINE_CODING command. (RO)

Register 31.26. USB_SERIAL_JTAG_SET_LINE_CODE_W1_REG (0x0054)

USB_SERIAL_JTAG_BCHAR_FORMAT Represents the value of bCharFormat set by host through SET_LINE_CODING command. (RO)

USB_SERIAL_JTAG_BPARITY_TYPE Represents the value of bParityType set by host through SET_LINE_CODING command. (RO)

USB_SERIAL_JTAG_BDATA_BITS Represents the value of bDataBits set by host through SET_LINE_CODING command. (RO)

Register 31.27. USB_SERIAL_JTAG_BUS_RESET_ST_REG (0x0068)

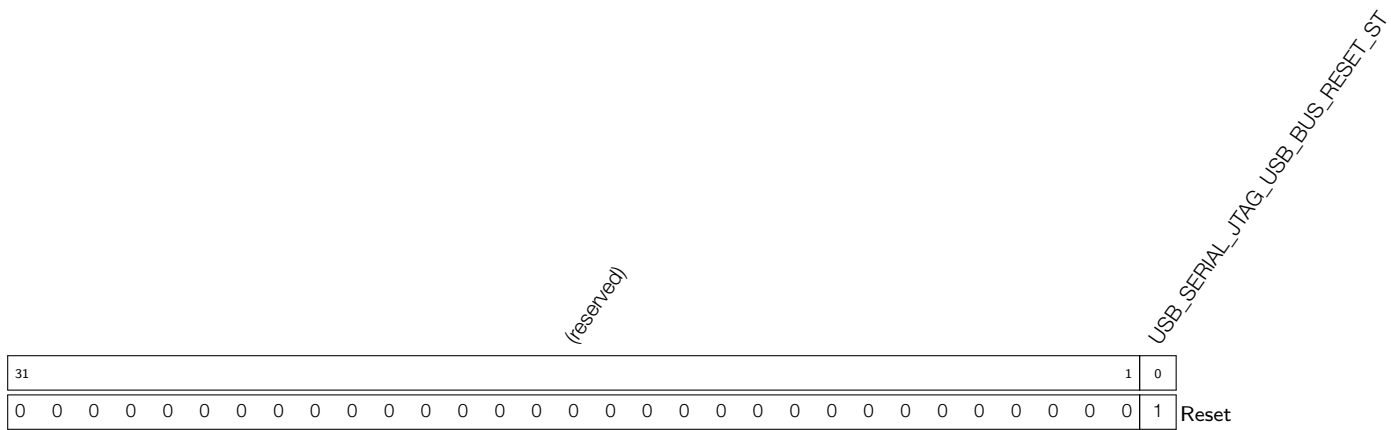

USB_SERIAL_JTAG_USB_BUS_RESET_ST Represents whether USB bus reset is released.
 0: USB Serial/JTAG is in USB bus reset status
 1: USB bus reset is released
 (RO)

Register 31.28. USB_SERIAL_JTAG_DATE_REG (0x0080)

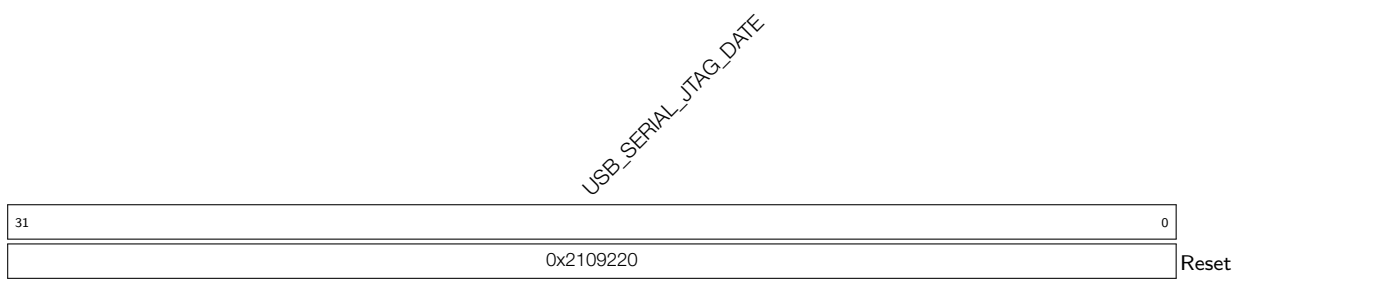

USB_SERIAL_JTAG_DATE Version control register. (R/W)

32 Two-wire Automotive Interface (TWAI)

The Two-wire Automotive Interface (TWAI®) is a multi-master, multi-cast communication protocol with functions such as error detection and signaling and inbuilt message priorities and arbitration. The TWAI protocol is suited for automotive and industrial applications (see Section 32.2 for more details).

ESP32-C6 contains two TWAI controllers named TWAI 0 and TWAI 1. Each controller can individually be connected to a TWAI bus via an external transceiver. The TWAI controllers contain numerous advanced features, and can be utilized in a wide range of use cases such as automotive products, industrial automation controls, building automation, etc.

32.1 Features

Each of the two TWAI controllers on ESP32-C6 support the following features:

- Compatibility with ISO 11898-1 protocol (CAN Specification 2.0)
- Standard Frame Format (11-bit ID) and Extended Frame Format (29-bit ID)
- Bit rates from 1 Kbit/s to 1 Mbit/s
- Multiple modes of operation:
 - Normal
 - Listen-only (no influence on bus)
 - Self-test (no acknowledgment required during data transmission)
- 64-byte Receive FIFO
- Special transmissions:
 - Single-shot transmissions (does not automatically re-transmit upon error)
 - Self Reception (the TWAI controller transmits and receives messages simultaneously)
- Acceptance Filter (supports single and dual filter modes)
- Error detection and handling:
 - Error Counters
 - Configurable Error Warning Limit
 - Error Code Capture
 - Arbitration Lost Capture
 - Automatic Transceiver Standby

32.2 Protocol Overview

32.2.1 TWAI Properties

The TWAI protocol connects two or more nodes in a bus network, and allows nodes to exchange messages with deterministic delay. A TWAI bus has the following properties:

Single Channel and Non-Return-to-Zero: The bus has only one transmission line for single-channel communication, which is half-duplex. Synchronization is also implemented in this channel, so extra channels (e.g., clock or enable) are not required. The bit stream of a TWAI message is encoded using the Non-Return-to-Zero (NRZ) method.

Bit Values: The single channel can either be in a dominant or recessive state, representing a logical 0 and a logical 1 respectively. A node transmitting data in a dominant state always overrides the other node transmitting data in a recessive state. The physical implementation on the bus is left to the application level to decide (e.g., differential pair or a single wire).

Bit Stuffing: Certain fields of TWAI messages are bit-stuffed. A transmitter that transmits five consecutive bits of the same value (e.g., dominant value or recessive value) should automatically insert a complementary bit. Likewise, a receiver that receives five consecutive bits of the same value should treat the next bit as a stuffed bit. Bit stuffing is applied to the following fields: SOF, arbitration field, control field, data field, and CRC sequence (see Section 32.2.2 for more details).

Multi-cast: All nodes receive the same bits as they are connected to the same bus. Data is consistent across all nodes unless there is a bus error (see Section 32.2.3 for more details).

Multi-master: Any node can initiate a transmission. If a transmission is already ongoing, a node will wait until the current transmission is over before initiating a new transmission.

Message Priority and Arbitration: If two or more nodes simultaneously initiate a transmission, the TWAI protocol ensures that one node will win arbitration of the bus. The arbitration field of the message transmitted by each node is used to determine which node will win the arbitration.

Error Detection and Signaling: Each node actively monitors the bus for errors, and signals the detected errors by transmitting an error frame.

Fault Confinement: Each node maintains a set of error counters that are incremented/decremented according to a set of rules. When the error counters surpass a certain threshold, the node will automatically eliminate itself from the network by switching itself off.

Configurable Bit Rate: The bit rate for a single TWAI bus is configurable. However, all nodes on the same bus must operate at the same bit rate.

Transmitters and Receivers: At any point in time, a TWAI node can either be a transmitter or a receiver.

- A node generating a message is a transmitter. The node remains a transmitter until the bus is idle or until the node loses arbitration. Please note that there could be multiple nodes that act as transmitters during arbitration.
- All nodes that are not transmitters are receivers.

32.2.2 TWAI Messages

TWAI nodes use messages to transmit data, and signal errors to other nodes when detecting errors on the bus. Messages are split into various frame types, and some frame types will have different frame formats.

The TWAI protocol has the following frame types:

- Data frame
- Remote frame
- Error frame

- Overload frame
- Interframe space

The TWAI protocol supports the following frame formats:

- Standard Frame Format (SFF) that uses a 11-bit identifier
- Extended Frame Format (EFF) that uses a 29-bit identifier

32.2.2.1 Data Frames and Remote Frames

Data frames are used by nodes to send data to other nodes, and can have a payload of 0 to 8 data bytes.

Remote frames are used for nodes to request a data frame with the same identifier from other nodes, and thus they do not contain any data bytes. However, data frames and remote frames share many fields. Figure 32-1 illustrates the fields and sub-fields of different frames and formats.

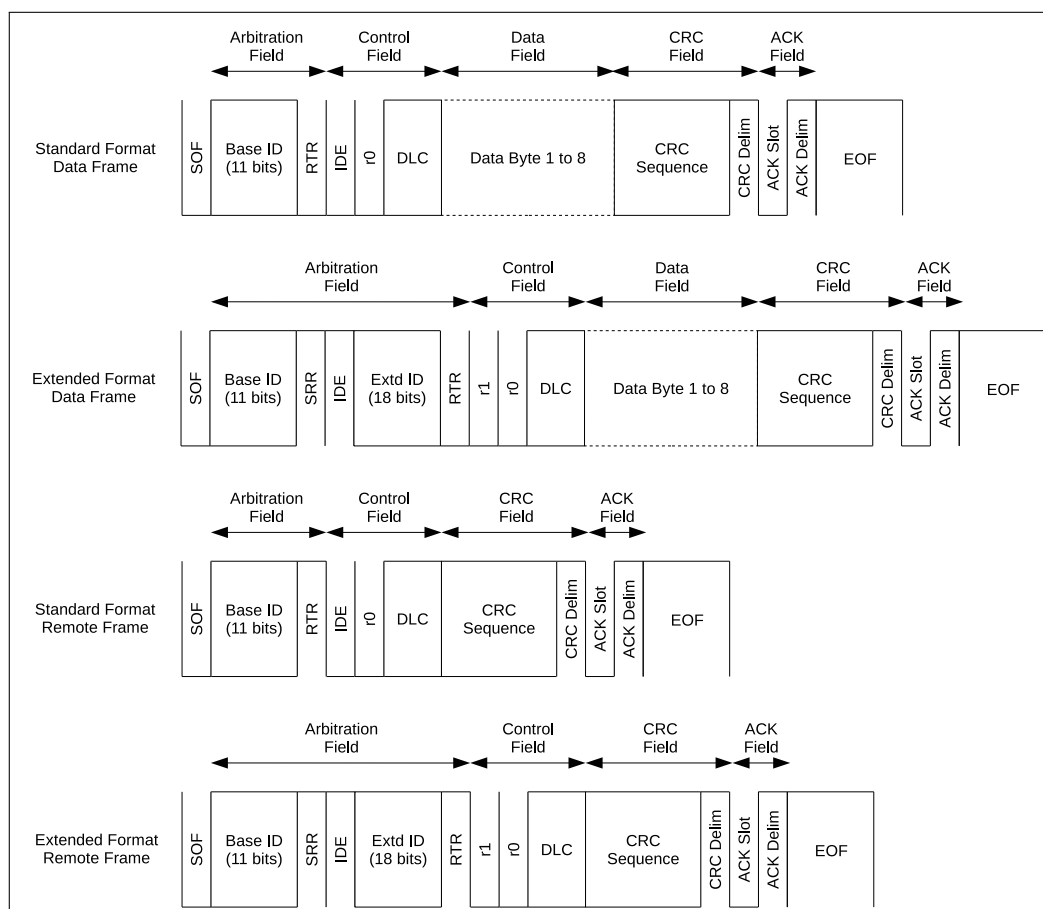

Figure 32-1. Bit Fields in Data Frames and Remote Frames

Arbitration Field

When two or more nodes transmit a data or remote frame simultaneously, the arbitration field is used to determine which node will win arbitration of the bus. In the arbitration field, if a node transmits a recessive bit while detecting a dominant bit, it indicates that another node has overridden its recessive bit. Therefore, the node transmitting the recessive bit has lost arbitration of the bus and should immediately switch to be a receiver.

The arbitration field primarily consists of a frame identifier that is transmitted from the most significant bit first. Given that a dominant bit represents a logical 0, and a recessive bit represents a logical 1:

- A frame with the smallest ID value always wins arbitration.
- Given the same ID and format, data frames always prevail over remote frames due to their RTR bits being dominant.
- Given the same first 11 bits of ID, a Standard Format Data Frame always prevails over an Extended Format Data Frame due to its SRR bits being recessive.

Control Field

The control field primarily consists of the DLC (Data Length Code) which indicates the number of payload data bytes for a data frame, or the number of requested data bytes for a remote frame. The DLC is transmitted from the most significant bit first.

Data Field

The data field contains the actual payload data bytes of a data frame. Remote frames do not contain any data field.

CRC Field

The CRC field primarily consists of a CRC sequence. The CRC sequence is a 15-bit cyclic redundancy code calculated from the de-stuffed contents (everything from the SOF to the end of the data field) of a data or remote frame.

ACK Field

The ACK field primarily consists of an ACK Slot and an ACK Delim. The ACK field indicates that the receiver has received an effective message from the transmitter.

Table 32-1. Data Frames and Remote Frames in SFF and EFF

Data/Remote Frames	Description
SOF	The SOF (Start of Frame) is a single dominant bit used to synchronize nodes on the bus.
Base ID	The Base ID (ID.28 to ID.18) is the 11-bit identifier for SFF, or the first 11 bits of the 29-bit identifier for EFF.
RTR	The RTR (Remote Transmission Request) bit indicates whether the message is a data frame (dominant) or a remote frame (recessive). This means that a remote frame will always lose arbitration to a data frame if they have the same ID.
SRR	The SRR (Substitute Remote Request) bit is transmitted in EFF to substitute for the RTR bit at the same position in SFF.
IDE	The IDE (Identifier Extension) bit indicates whether the message is SFF (dominant) or EFF (recessive). This means that a SFF frame will always win arbitration over an EFF frame if they have the same Base ID.
Extd ID	The Extended ID (ID.17 to ID.0) is the remaining 18 bits of the 29-bit identifier for EFF.
r1	The r1 bit (reserved bit 1) is always dominant.
r0	The r0 bit (reserved bit 0) is always dominant.
DLC	The DLC (Data Length Code) is 4-bit long and should contain any value from 0 to 8. Data frames use the DLC to indicate the number of data bytes in the data frame. Remote frames used the DLC to indicate the number of data bytes to request from another node.

Cont'd on next page

Table 32-1 – cont'd from previous page

Data/Remote Frames	Description
Data Bytes	The data payload of data frames. The number of bytes should match the value of DLC. Data byte 0 is transmitted first, and each data byte is transmitted from the most significant bit first.
CRC Sequence	The CRC sequence is a 15-bit cyclic redundancy code.
CRC Delim	The CRC Delim (CRC Delimiter) is a single recessive bit that follows the CRC sequence.
ACK Slot	The ACK Slot (Acknowledgment Slot) is intended for receiver nodes to indicate that the data or remote frame was received without any issue. The transmitter node will send a recessive bit in the ACK Slot and receiver nodes should override the ACK Slot with a dominant bit if the frame was received without errors.
ACK Delim	The ACK Delim (Acknowledgment Delimiter) is a single recessive bit.
EOF	The EOF (End of Frame) marks the end of a data or remote frame, and consists of seven recessive bits.

32.2.2.2 Error and Overload Frames

Error Frames

Error frames are transmitted when a node detects a bus error. Error frames notably consist of an Error Flag which is made up of six consecutive bits of the same value, thus violating the bit-stuffing rule. Therefore, when a particular node detects a bus error and transmits an error frame, all other nodes will then detect a stuff error and transmit their own error frames in response. This has the effect of propagating the detection of a bus error across all nodes on the bus.

When a node detects a bus error, it will transmit an error frame starting from the next bit. However, when a node detects a CRC error, the error frame will start at the bit following the ACK Delim (see Section 32.2.3 for more details). The following Figure 32-2 shows different fields of an error frame:

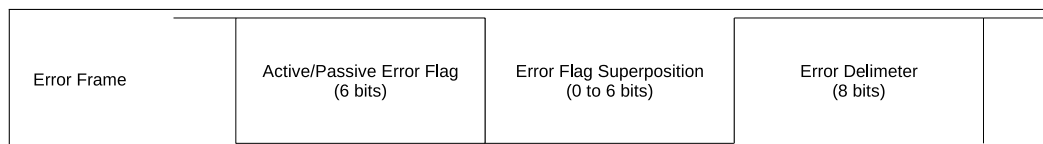

Figure 32-2. Fields of an Error Frame

Table 32-2. Error Frame

Error Frame	Description
Error Flag	The Error Flag has two forms, the Active Error Flag consisting of six dominant bits and the Passive Error Flag consisting of six recessive bits (unless overridden by dominant bits of other nodes). Active Error Flags are sent by error active nodes, whilst Passive Error Flags are sent by error passive nodes.

Cont'd on next page

Table 32-2 – cont'd from previous page

Error Frame	Description
Error Flag Superposition	The Error Flag Superposition field meant to allow for other nodes on the bus to transmit their respective Active Error Flags. The superposition field can range from 0 to 6 bits, and ends when the first recessive bit is detected (i.e., the first bit of the Delimiter).
Error Delimiter	The Delimiter field marks the end of the error/overload frame, and consists of eight recessive bits.

Overload Frames

An overload frame has the same bit fields as an error frame containing an Active Error Flag. The key difference is in the cases that can trigger the transmission of an overload frame. Figure 32-3 below shows the bit fields of an overload frame.

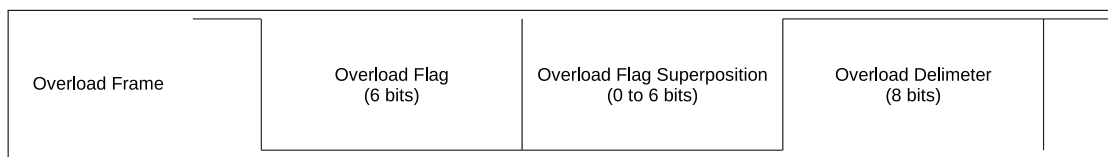

Figure 32-3. Fields of an Overload Frame

Table 32-3. Overload Frame

Overload Flag	Description
Overload Flag	Consists of six dominant bits. Same as an Active Error Flag.
Overload Flag Superposition	Allows for the superposition of Overload Flags from other nodes, similar to an Error Flag Superposition.
Overload Delimiter	Consists of eight recessive bits. Same as an Error Delimiter.

Overload frames will be transmitted in the following cases:

1. A receiver requires a delay of the next data or remote frame.
2. A dominant bit is detected at the first and second bit of intermission.
3. A dominant bit is detected at the eighth (last) bit of an Error Delimiter. Note that in this case, TEC and REC will not be incremented (see Section 32.2.3 for more details).

Transmitting an overload frame due to one of the above cases must also satisfy the following rules:

- The start of an overload frame due to case 1 is only allowed to be started at the first bit time of an expected intermission.
- The start of an overload frame due to case 2 and 3 is only allowed to be started one bit after detecting the dominant bit.
- For case 1, a maximum of two overload frames may be generated in order to delay the transmission of the next data or remote frame.

32.2.2.3 Interframe Space

The Interframe Space acts as a separator between frames. Data frames and remote frames must be separated from preceding frames by an Interframe Space, regardless of the preceding frame's type (data frame, remote frame, error frame, or overload frame). However, error frames and overload frames do not need to be separated from preceding frames.

Figure 32-4 shows the fields within an Interframe Space:

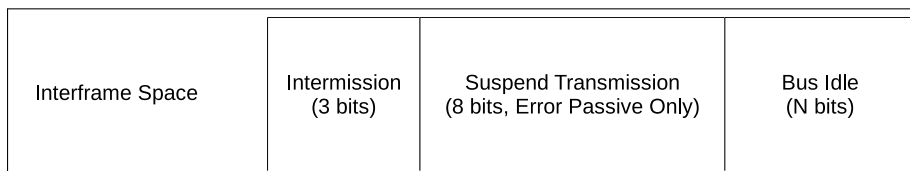

Figure 32-4. The Fields within an Interframe Space

Table 32-4. Interframe Space

Interframe Space	Description
Intermission	The Intermission consists of three recessive bits.
Suspend Transmission	An Error Passive node that has just transmitted a message must include a Suspend Transmission field. This field consists of eight recessive bits. Error Active nodes should not include this field.
Bus Idle	The Bus Idle field is of arbitrary length. Bus Idle ends when an SOF is transmitted. If a node has a pending transmission, the SOF should be transmitted at the first bit following Intermission.

32.2.3 TWAI Errors

32.2.3.1 Error Types

Bus Errors in TWAI are categorized into the following types:

Bit Error

A Bit Error occurs when a node transmits a bit value (i.e., dominant or recessive) but detects an opposite bit (e.g., a dominant bit is transmitted but a recessive is detected). However, if the transmitted bit is recessive and is located in the Arbitration Field or ACK Slot or Passive Error Flag, then detecting a dominant bit will not be considered as a Bit Error.

Stuff Error

A stuff error occurs when six consecutive bits of the same value are detected (which violates the bit-stuffing encoding rules).

CRC Error

A receiver of a data or remote frame will calculate CRC based on the bits it has received. A CRC error occurs when the CRC calculated by the receiver does not match the CRC sequence in the received data or remote Frame.

Format Error

A Format Error occurs when a format-fixed bit field of a message contains an illegal bit. For example, the r1 and

r0 fields must be dominant.

ACK Error

An ACK Error occurs when a transmitter does not detect a dominant bit at the ACK Slot.

32.2.3.2 Error States

TWAI nodes implement fault confinement by maintaining two error counters in each node, where the counter values determine the error state. The two error counters are known as the Transmit Error Counter (TEC) and Receive Error Counter (REC). TWAI has the following error states:

Error Active

An Error Active node is able to participate in bus communication and transmit an Active Error Flag when it detects an error.

Error Passive

An Error Passive node is able to participate in bus communication and transmit a Passive Error Flag when it detects an error. Error Passive nodes that have transmitted a data or remote frame must also include the Suspend Transmission field in the subsequent Interframe Space.

Bus Off

A Bus Off node is not permitted to influence the bus in any way (i.e., is not allowed to transmit data).

32.2.3.3 Error Counters

The TEC and REC are incremented/decremented according to the following rules. **Note that more than one rule can apply to a given message transfer.**

1. When a receiver detects an error, the REC is increased by 1, except when the detected error was a Bit Error during the transmission of an Active Error Flag or an Overload Flag.
2. When a receiver detects a dominant bit as the first bit after sending an Error Flag, the REC is increased by 8.
3. When a transmitter sends an Error Flag, the TEC is increased by 8. However, the following scenarios are exempt from this rule:
 - A transmitter is Error Passive and no dominant bit is detected when an Acknowledgment Error is detected and the Passive Error Flag is sent. In this case, the TEC should not be increased.
 - A transmitter transmits an Error Flag due to a Stuff Error during Arbitration. If the stuffed bit should have been recessive but was monitored as dominant, then the TEC should not be increased.
4. If a transmitter detects a Bit Error whilst sending an Active Error Flag or Overload Flag, the TEC is increased by 8.
5. If a receiver detects a Bit Error while sending an Active Error Flag or Overload Flag, the REC is increased by 8.
6. A node can tolerate up to 7 consecutive dominant bits after sending an Active/Passive Error Flag, or Overload Flag. After detecting the 14th consecutive dominant bit when sending an Active Error Flag or Overload Flag, or the 8th consecutive dominant bit following a Passive Error Flag, a transmitter will increase its TEC by 8 and a receiver will increase its REC by 8. Every additional 8 consecutive dominant bits will also increase the TEC for transmitters or REC for receivers by 8 as well.

7. When a transmitter has transmitted a message, which means getting ACK and no errors until the EOF is completed, the TEC is decremented by 1, unless the TEC is already at 0.
8. When a receiver successfully receives a message, which means getting no errors before ACK Slot and successfully sending ACK, the REC is decremented accordingly.
 - If the REC is between 1 and 127, the REC will be decremented by 1.
 - If the REC is greater than 127, the REC will be set to 127.
 - If the REC is 0, the REC will remain 0.
9. A node becomes Error Passive when its TEC and/or REC is greater than or equal to 128. Though the node becomes Error Passive, it still sends an Active Error Flag. Note that once the REC has reached to 128, any further increases to its value are invalid until the REC returns to a value less than 128.
10. A node becomes Bus Off when its TEC is greater than or equal to 256.
11. An Error Passive node becomes Error Active when both the TEC and REC are less than or equal to 127.
12. A Bus Off node can become Error Active (with both its TEC and REC reset to 0) after it monitors 128 occurrences of 11 consecutive recessive bits on the bus.

32.2.4 TWAI Bit Timing

32.2.4.1 Nominal Bit

The TWAI protocol allows a TWAI bus to operate at a particular bit rate. However, all nodes within a TWAI bus must operate at the same bit rate.

- **The Nominal Bit Rate** is defined as the number of bits transmitted per second.
- **The Nominal Bit Time** is defined as $1/\text{Nominal Bit Rate}$.

A single Nominal Bit Time is divided into multiple segments, and each segment is made up of multiple Time Quanta. A **Time Quantum** is a minimum unit of time, and is implemented as some form of prescaled clock signal in each node. Figure 32-5 illustrates the segments within a single Nominal Bit Time.

TWAI controllers will operate in time steps of one Time Quanta where the state of the TWAI bus is analyzed. If the bus states in two consecutive Time Quanta are different (i.e., recessive to dominant or vice versa), it means an edge is generated. The intersection of PBS1 and PBS2 is considered the Sample Point and the sampled bus value is considered the value of that bit.

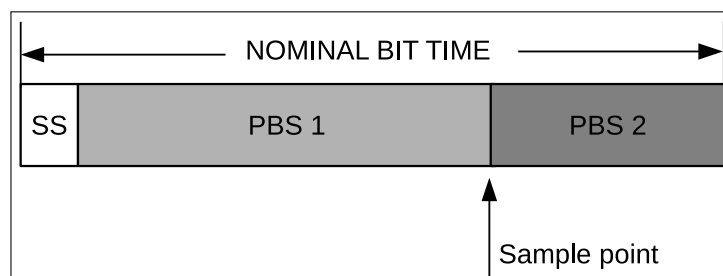

Figure 32-5. Layout of a Bit

Table 32-5. Segments of a Nominal Bit Time

Segment	Description
SS	The SS (Synchronization Segment) is 1 Time Quantum long. If all nodes are perfectly synchronized, the edge of a bit will lie in the SS.
PBS1	PBS1 (Phase Buffer Segment 1) can be 1 to 16 Time Quanta long. PBS1 is meant to compensate for the physical delay times within the network. PBS1 can also be lengthened for synchronization purposes.
PBS2	PBS2 (Phase Buffer Segment 2) can be 1 to 8 Time Quanta long. PBS2 is meant to compensate for the information processing time of nodes. PBS2 can also be shortened for synchronization purposes.

32.2.4.2 Hard Synchronization and Resynchronization

Due to clock skew and jitter, the bit timing of nodes on the same bus may become out of phase. Therefore, a bit edge may come before or after the SS. To ensure that the internal bit timing clocks of each node are kept in phase, TWAI has various methods of synchronization. The **Phase Error “e”** is measured in the number of Time Quanta and relative to the SS.

- A positive Phase Error ($e > 0$) is when the edge lies after the SS and before the Sample Point (i.e., the edge is late).
- A negative Phase Error ($e < 0$) is when the edge lies after the Sample Point of the previous bit and before SS (i.e., the edge is early).

To correct for Phase Errors, there are two forms of synchronization, known as **Hard Synchronization** and **Resynchronization**. **Hard Synchronization** and **Resynchronization** obey the following rules:

- Only one synchronization may occur in a single bit time.
- Synchronizations only occurs on recessive to dominant edges.

Hard Synchronization

Hard Synchronization occurs on the recessive to dominant (i.e., the first SOF bit after Bus Idle) edges when the bus is idle. All nodes will restart their internal bit timings so that the recessive to dominant edge lies within the SS of the restarted bit timing.

Resynchronization

Resynchronization occurs on recessive to dominant edges when the bus is not idle. If the edge has a positive Phase Error ($e > 0$), PBS1 is lengthened by a certain number of Time Quanta. If the edge has a negative Phase Error ($e < 0$), PBS2 will be shortened by a certain number of Time Quanta.

The number of Time Quanta to lengthen or shorten depends on the magnitude of the Phase Error, and is also limited by the Synchronization Jump Width (SJW) value which is programmable.

- When the magnitude of the Phase Error (**e**) is less than or equal to the SJW, PBS1/PBS2 are lengthened/shortened by the **e** number of Time Quanta. This has a same effect as Hard Synchronization.
- When the magnitude of the Phase Error is greater to the SJW, PBS1/PBS2 are lengthened/shortened by the SJW number of Time Quanta. This means it may take multiple bits of synchronization before the Phase Error is entirely corrected.

32.3 Architectural Overview

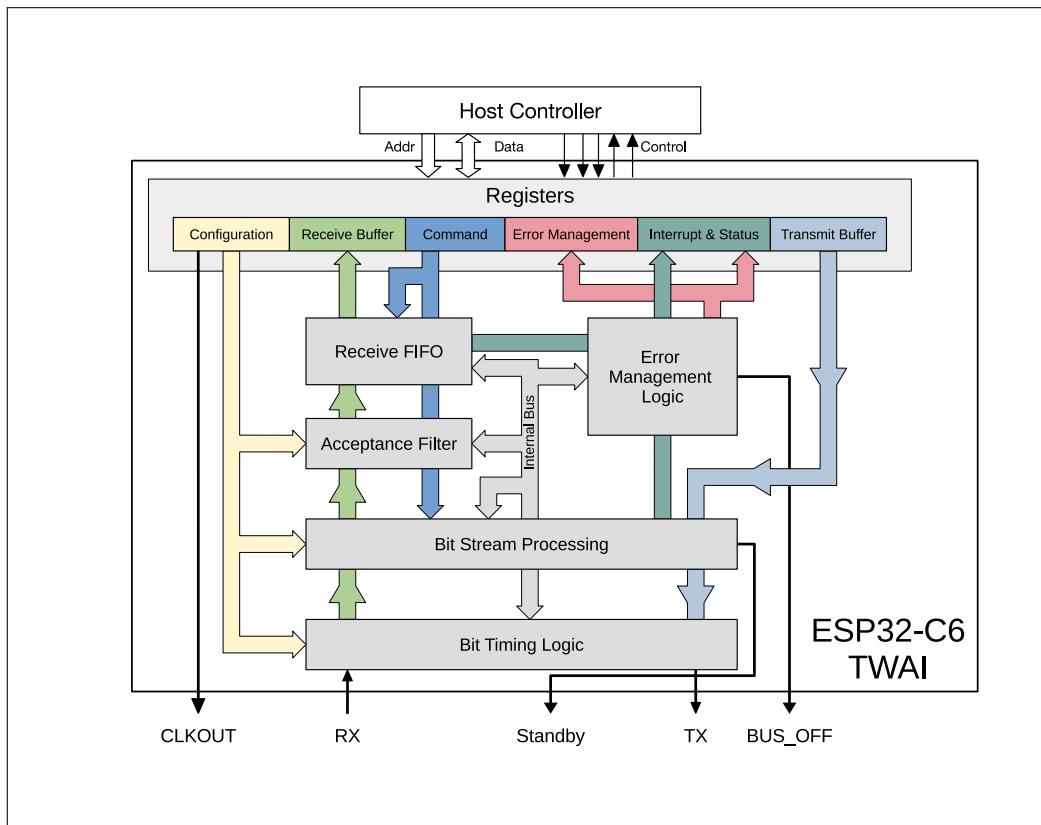

Figure 32-6. TWAI Overview Diagram

The major functional blocks of the TWAI controller are shown in Figure 32-6.

32.3.1 Registers Block

The ESP32-C6 CPU accesses peripherals using 32-bit aligned words. However, the majority of registers in the TWAI controller only contain useful data at the least significant byte (bits [7:0]). Therefore, in these registers, bits [31:8] are ignored on writes, and return 0 on reads.

Configuration Registers

The configuration registers store various configuration items for the TWAI controller such as bit rates, operation mode, Acceptance Filter, etc. Configuration registers can only be modified whilst the TWAI controller is in Reset Mode (See Section 32.4.1).

Command Registers

The command register is used by the CPU to drive the TWAI controller to initiate certain actions such as transmitting a message or clearing the Receive Buffer. The command register can only be modified when the TWAI controller is in Operation Mode (see section 32.4.1).

Interrupt & Status Registers

The interrupt register indicates what events have occurred in the TWAI controller (each event is represented by a separate bit). The status register indicates the current status of the TWAI controller.

Error Management Registers

The error management registers include error counters and capture registers. The error counter registers represent TEC and REC values. The capture registers will record information about instances where TWAI

controller detects a bus error, or when it loses arbitration.

Transmit Buffer Registers

The transmit buffer is a 13-byte buffer used to store a TWAI message to be transmitted.

Receive Buffer Registers

The Receive Buffer is a 13-byte buffer which stores a single message. The Receive Buffer acts as a window of Receive FIFO, whose first message will be mapped into the Receive Buffer.

Note that the Transmit Buffer registers, Receive Buffer registers, and the Acceptance Filter registers share the same address range (offset 0x0040 to 0x0070). Their access is governed by the following rules:

- When the TWAI controller is in Reset Mode, all reads and writes to the address range maps to the Acceptance Filter registers.
- When the TWAI controller is in Operation Mode:
 - All reads to the address range maps to the Receive Buffer registers.
 - All writes to the address range maps to the Transmit Buffer registers.

32.3.2 Bit Stream Processor

The Bit Stream Processing (BSP) module handles the frame processing of data from the Transmit Buffer (e.g. bit stuffing and additional CRC fields) and generates a bit stream for the Bit Timing Logic (BTL) module. At the same time, the BSP module is also responsible for processing the received bit stream (e.g., de-stuffing and verifying CRC) from the BTL module and placing the message into the Receive FIFO. The BSP will also detect errors on the TWAI bus and report them to the Error Management Logic (EML).

32.3.3 Error Management Logic

The Error Management Logic (EML) module updates the TEC and REC, records error information like error types and positions, and updates the error state of the TWAI controller such that the BSP module generates the correct Error Flags. Furthermore, this module also records the bit position when the TWAI controller loses arbitration.

32.3.4 Bit Timing Logic

The Bit Timing Logic (BTL) module transmits and receives messages at the configured bit rate. The BTL module also handles bit timing synchronization so that communication remains stable. A single bit time consists of multiple programmable segments that allows users to set the length of each segment to account for factors such as propagation delay and controller processing time, etc.

32.3.5 Acceptance Filter

The Acceptance Filter is a programmable message filtering unit that allows the TWAI controller to accept or reject a received message based on the message's ID field. Only accepted messages will be stored in the Receive FIFO. The Acceptance Filter's registers can be programmed to specify a single filter, or two separate filters (dual filter mode).

32.3.6 Receive FIFO

The Receive FIFO is a 64-byte buffer (inside the TWAI controller) that stores received messages accepted by the Acceptance Filter. Messages in the Receive FIFO can vary in size (between 3 to 13 bytes). When the Receive FIFO is full (or does not have enough space to store the current received message in its entirety), the Overrun Interrupt will be triggered, and any subsequent received messages will be lost until adequate space is cleared in the Receive FIFO. The first message in the Receive FIFO will be mapped to the 13-byte Receive Buffer until that message is cleared (using the Release Receive Buffer command bit). After being cleared, the Receive Buffer will map to the next message in the Receive FIFO, and the space occupied by the previous message in the Receive FIFO can be used to receive new messages.

32.4 Functional Description

32.4.1 Modes

The ESP32-C6 TWAI controller has two working modes: Reset Mode and Operation Mode. Reset Mode and Operation Mode are entered by setting or clearing the `TWAI_RESET_MODE` bit.

32.4.1.1 Reset Mode

Entering Reset Mode is required in order to modify the various configuration registers of the TWAI controller. When entering Reset Mode, the TWAI controller is essentially disconnected from the TWAI bus. When in Reset Mode, the TWAI controller will not be able to transmit any messages (including error signals). Any transmission in progress is immediately terminated. Likewise, the TWAI controller will not be able to receive any messages either.

32.4.1.2 Operation Mode

In operation mode, the TWAI controller connects to the bus and write-protect all configuration registers to ensure consistency during operation. When in Operation Mode, the TWAI controller can transmit and receive messages (including error signaling) depending on which operation sub-mode the TWAI controller was configured with. The TWAI controller supports the following operation sub-modes:

- **Normal Mode:** The TWAI controller can transmit and receive messages including error signals (such as error and overload Frames).
- **Self-test Mode:** Self-test mode is similar to normal Mode, but the TWAI controller will consider the transmission of a data or remote frame successful and do not generate an ACK error even if it was not acknowledged. This is commonly used when the TWAI controller does self-test.
- **Listen-only Mode:** The TWAI controller will be able to receive messages, but will remain completely passive on the TWAI bus. Thus, the TWAI controller will not be able to transmit any messages, acknowledgments, or error signals. The error counters will remain frozen. This mode is useful for TWAI bus monitoring.

Note that when exiting Reset Mode (i.e., entering Operation Mode), the TWAI controller must wait for 11 consecutive recessive bits to occur before being able to fully connect the TWAI bus (i.e., be able to transmit or receive).

32.4.2 Bit Timing

The operating bit rate of the TWAI controller must be configured whilst the TWAI controller is in Reset Mode. The bit rate is configured using `TWAI_BUS_TIMING_0_REG` and `TWAI_BUS_TIMING_1_REG`, and the two registers contain the following fields:

The following Table 32-6 illustrates the bit fields of `TWAI_BUS_TIMING_0_REG`. The frequency of the TWAI core clock has multiple clock sources that can be configured by the user as needed. See Chapter 8 *Reset and Clock* for detailed configuration instructions.

Table 32-6. Bit Information of `TWAI_BUS_TIMING_0_REG` (0x18)

Bit 31-16	Bit 15	Bit 14	Bit 13	Bit 12	Bit 1	Bit 0
Reserved	SJW.1	SJW.0	BRP.13	BRP.12	BRP.1	BRP.0

Notes:

- BRP: The TWAI Time Quanta clock is derived from the XTAL clock (the default is 40 MHz and is configured). The Baud Rate Prescaler (BRP) field is used to define the prescaler according to the equation below, where t_{Tq} is the Time Quanta clock cycle and t_{CLK} is TWAI core clock cycle:

$$t_{Tq} = 2 \times t_{CLK} \times (2^{13} \times \text{BRP.13} + 2^{12} \times \text{BRP.12} + 2^{11} \times \text{BRP.11} + \dots + 2^1 \times \text{BRP.1} + 2^0 \times \text{BRP.0} + 1)$$
- SJW: Synchronization Jump Width (SJW) is configured in SJW.0 and SJW.1 where $\text{SJW} = (2 \times \text{SJW.1} + \text{SJW.0} + 1)$

The following Table 32-7 illustrates the bit fields of `TWAI_BUS_TIMING_1_REG`.

Table 32-7. Bit Information of `TWAI_BUS_TIMING_1_REG` (0x1c)

Bit 31-8	Bit 7	Bit 6	Bit 5	Bit 4	Bit 3	Bit 2	Bit 1	Bit 0
Reserved	SAM	PBS2.2	PBS2.1	PBS2.0	PBS1.3	PBS1.2	PBS1.1	PBS1.0

Notes:

- PBS1: The number of Time Quanta in Phase Buffer Segment 1 is defined according to the following equation: $(8 \times \text{PBS1.3} + 4 \times \text{PBS1.2} + 2 \times \text{PBS1.1} + \text{PBS1.0} + 1)$
- PBS2: The number of Time Quanta in Phase Buffer Segment 2 is defined according to the following equation: $(4 \times \text{PBS2.2} + 2 \times \text{PBS2.1} + \text{PBS2.0} + 1)$
- SAM: Enables triple sampling if set to 1. This is useful for low/medium speed buses to filter spikes on the bus line.

32.4.3 Interrupt Management

The ESP32-C6 TWAI controller provides eight interrupts, each represented by a single bit in the `TWAI_INT_ST_REG`. For a particular interrupt to be triggered, the corresponding enable bit in `TWAI_INT_ENA_REG` must be set.

The TWAI controller provides the following interrupts:

- Receive Interrupt
- Transmit Interrupt
- Error Warning Interrupt

- Data Overrun Interrupt
- Error Passive Interrupt
- Arbitration Lost Interrupt
- Bus Error Interrupt
- Bus Idle Status Interrupt

The TWAI controller's interrupt signal to the interrupt matrix will be asserted whenever one or more interrupt bits are set in the [TWAI_INT_ST_REG](#), and de-asserted when all bits in [TWAI_INT_ST_REG](#) are cleared. The majority of interrupt bits in [TWAI_INT_ST_REG](#) are automatically cleared when the register is read, except for the Receive Interrupt which can only be cleared when all the messages are released by setting the [TWAI_RELEASE_BUF](#) bit.

32.4.3.1 Receive Interrupt (RXI)

The Receive Interrupt (RXI) is asserted whenever the TWAI controller has received messages that are pending to be read from the Receive Buffer (i.e., when [TWAI_RX_MESSAGE_CNT_REG](#) > 0). Pending received messages includes valid messages in the Receive FIFO and also overrun messages. The RXI will not be deasserted until all pending received messages are cleared using the [TWAI_RELEASE_BUF](#) command bit.

32.4.3.2 Transmit Interrupt (TXI)

The Transmit Interrupt (TXI) is triggered whenever Transmit Buffer becomes free, indicating another message can be loaded into the Transmit Buffer to be transmitted. The Transmit Buffer becomes free under the following scenarios:

- A message transmission has completed successfully, i.e., acknowledged without any errors. Any failed messages will automatically be resent.
- A single shot transmission has completed (successfully or unsuccessfully, indicated by the [TWAI_TX_COMPLETE](#) bit).
- A message transmission was aborted using the [TWAI_ABORT_TX](#) command bit.

32.4.3.3 Error Warning Interrupt (EWI)

The Error Warning Interrupt (EWI) is triggered whenever there is a change to the [TWAI_ERR_ST](#) and [TWAI_BUS_OFF_ST](#) bits of the [TWAI_STATUS_REG](#) (i.e., transition from 0 to 1 or vice versa). Thus, an EWI could indicate one of the following events, depending on the values [TWAI_ERR_ST](#) and [TWAI_BUS_OFF_ST](#) at the moment when the EWI is triggered.

- If [TWAI_ERR_ST](#) = 0 and [TWAI_BUS_OFF_ST](#) = 0:
 - If the TWAI controller was in the Error Active state, it indicates both the TEC and REC have returned below the threshold value set by [TWAI_ERR_WARNING_LIMIT_REG](#).
 - If the TWAI controller was previously in the Bus Off Recovery state, it indicates that Bus Recovery has completed successfully.
- If [TWAI_ERR_ST](#) = 1 and [TWAI_BUS_OFF_ST](#) = 0: The TEC or REC error counters have exceeded the threshold value set by [TWAI_ERR_WARNING_LIMIT_REG](#).

- If `TWAI_ERR_ST` = 1 and `TWAI_BUS_OFF_ST` = 1: The TWAI controller has entered the `BUS_OFF` state (due to the `TEC` \geq 256).
- If `TWAI_ERR_ST` = 0 and `TWAI_BUS_OFF_ST` = 1: The TWAI controller's `TEC` has dropped below the threshold value set by `TWAI_ERR_WARNING_LIMIT_REG` during `BUS_OFF` recovery.

32.4.3.4 Data Overrun Interrupt (DOI)

The Data Overrun Interrupt (DOI) is triggered whenever the Receive FIFO has overrun. The DOI indicates that the Receive FIFO is full and should be cleared immediately to prevent any further overrun messages.

The DOI is only triggered by the first message that causes the Receive FIFO to overrun (i.e., the transition from the Receive FIFO not being full to the Receive FIFO overflowing). Any subsequent overrun messages will not trigger the DOI again. The DOI could be triggered again when all received messages (valid or overrun) have been cleared.

32.4.3.5 Error Passive Interrupt (TXI)

The Error Passive Interrupt (EPI) is triggered whenever the TWAI controller switches from Error Active to Error Passive, or vice versa.

32.4.3.6 Arbitration Lost Interrupt (ALI)

The Arbitration Lost Interrupt (ALI) is triggered whenever the TWAI controller is attempting to transmit a message and loses arbitration. The bit position where the TWAI controller lost arbitration is automatically recorded in Arbitration Lost Capture register (`TWAI_ARB_LOST_CAP_REG`). When the ALI occurs again, the Arbitration Lost Capture register will no longer record new bit location until it is cleared (via CPU reading this register).

32.4.3.7 Bus Error Interrupt (BEI)

The Bus Error Interrupt (BEI) is triggered whenever TWAI controller detects an error on the TWAI bus. When a bus error occurs, the Bus Error type and its bit position are automatically recorded in the Error Code Capture register (`TWAI_ERR_CODE_CAP_REG`). When the BEI occurs again, the Error Code Capture register will no longer record new error information until it is cleared (via a read from the CPU).

32.4.3.8 Bus Idle Status Interrupt (BISI)

The Bus Idle Status Interrupt (BISI) is triggered when the number of clock cycles of the TWAI controller in the idle status exceeds the pre-configured value in the `TWAI_IDLE_INTR_CNT_REG` register. Users can configure this interrupt to get the TWAI controller idle status and further decide whether to turn off the external TWAI receiver to reduce the overall power consumption (see Section 32.4.10).

32.4.4 Transmit and Receive Buffers

32.4.4.1 Overview of Buffers

Table 32-8. Buffer Layout for Standard Frame Format and Extended Frame Format

Standard Frame Format (SFF)		Extended Frame Format (EFF)	
Offset Address	Content	Offset Address	Content
0x40	TX/RX frame information	0x40	TX/RX frame information
0x44	TX/RX identifier 1	0x44	TX/RX identifier 1
0x48	TX/RX identifier 2	0x48	TX/RX identifier 2
0x4c	TX/RX data byte 1	0x4c	TX/RX identifier 3
0x50	TX/RX data byte 2	0x50	TX/RX identifier 4
0x54	TX/RX data byte 3	0x54	TX/RX data byte 1
0x58	TX/RX data byte 4	0x58	TX/RX data byte 2
0x5c	TX/RX data byte 5	0x5c	TX/RX data byte 3
0x60	TX/RX data byte 6	0x60	TX/RX data byte 4
0x64	TX/RX data byte 7	0x64	TX/RX data byte 5
0x68	TX/RX data byte 8	0x68	TX/RX data byte 6
0x6c	reserved	0x6c	TX/RX data byte 7
0x70	reserved	0x70	TX/RX data byte 8

Table 32-8 illustrates the layout of the Transmit Buffer and Receive Buffer registers. Both the Transmit and Receive Buffer registers share the same address space and are only accessible when the TWAI controller is in Operation Mode. The CPU accesses Transmit Buffer registers for write operations, and Receive Buffer registers for read operations. Both buffers share the exact same register layout and fields to store a message (received or to be transmitted). The Transmit Buffer registers are used to configure a TWAI message to be transmitted. The CPU would write to the Transmit Buffer registers specifying the message's frame type, frame format, frame ID, and frame data (payload). Once the Transmit Buffer is configured, the CPU would then initiate the transmission by setting the [TWAI_TX_REQ](#) bit in [TWAI_CMD_REG](#).

- For a self-reception request, set the [TWAI_SELF_RX_REQ](#) bit instead.
- For a single-shot transmission, set both the [TWAI_TX_REQ](#) and the [TWAI_ABORT_TX](#) simultaneously.

The Receive Buffer registers map the first message in the Receive FIFO. The CPU would read the Receive Buffer registers to obtain the first message's frame type, frame format, frame ID, and frame data (payload). Once the message has been read from the Receive Buffer registers, the CPU can set the [TWAI_RELEASE_BUF](#) bit in [TWAI_CMD_REG](#) to clear the Receive Buffer registers. If there are still messages in the Receive FIFO, the Receive Buffer registers will map the first of the remaining messages again.

32.4.4.2 Frame Information

The frame information is one byte long and specifies a message's frame type, frame format, and length of data. The frame information fields are shown in Table 32-9.

Table 32-9. TX/RX Frame Information (SFF/EFF) TWAI Address 0x40

Bit 31-8	Bit 7	Bit 6	Bit 5	Bit 4	Bit 3	Bit 2	Bit 1	Bit 0
Reserved	FF ¹	RTR ²	X ³	X ³	DLC.3 ⁴	DLC.2 ⁴	DLC.1 ⁴	DLC.0 ⁴

Notes:

1. FF: The Frame Format (FF) bit specifies whether the message is Extended Frame Format (EFF) or Standard

Frame Format (SFF). The message is EFF when FF bit is 1, and SFF when FF bit is 0.

2. RTR: The Remote Transmission Request (RTR) bit specifies whether the message is a data frame or a remote frame. The message is a remote frame when the RTR bit is 1, and a data frame when the RTR bit is 0.
3. X: Don't care, can be any value.
4. DLC: The Data Length Code (DLC) field specifies the number of data bytes for a data frame, or the number of data bytes to request in a remote frame. TWAI data frames are limited to a maximum payload of 8 data bytes, and thus the DLC should range anywhere from 0 to 8.

32.4.4.3 Frame Identifier

The Frame Identifier fields occupies two-byte (11-bit) long if the message is SFF, and four-byte (29-bit) long if the message is EFF.

The Frame Identifier fields for an SFF (11-bit) message is shown in Table 32-10 ~ 32-11.

Table 32-10. TX/RX Identifier 1 (SFF); TWAI Address 0x44

Bit 31-8	Bit 7	Bit 6	Bit 5	Bit 4	Bit 3	Bit 2	Bit 1	Bit 0
Reserved	ID.10	ID.9	ID.8	ID.7	ID.6	ID.5	ID.4	ID.3

Table 32-11. TX/RX Identifier 2 (SFF); TWAI Address 0x48

Bit 31-8	Bit 7	Bit 6	Bit 5	Bit 4	Bit 3	Bit 2	Bit 1	Bit 0
Reserved	ID.2	ID.1	ID.0	X ¹	X ²	X ²	X ²	X ²

Notes:

1. Don't care. Recommended to be compatible with receive buffer (i.e., set to RTR) in case of using the self reception functionality (or together with self-test functionality).
2. Don't care. Recommended to be compatible with receive buffer (i.e., set to 0) in case of using the self reception functionality (or together with self-test functionality).

The Frame Identifier fields for an EFF (29-bits) message is shown in Table 32-12 ~ 32-15.

Table 32-12. TX/RX Identifier 1 (EFF); TWAI Address 0x44

Bit 31-8	Bit 7	Bit 6	Bit 5	Bit 4	Bit 3	Bit 2	Bit 1	Bit 0
Reserved	ID.28	ID.27	ID.26	ID.25	ID.24	ID.23	ID.22	ID.21

Table 32-13. TX/RX Identifier 2 (EFF); TWAI Address 0x48

Bit 31-8	Bit 7	Bit 6	Bit 5	Bit 4	Bit 3	Bit 2	Bit 1	Bit 0
Reserved	ID.20	ID.19	ID.18	ID.17	ID.16	ID.15	ID.14	ID.13

Table 32-14. TX/RX Identifier 3 (EFF); TWAI Address 0x4c

Bit 31-8	Bit 7	Bit 6	Bit 5	Bit 4	Bit 3	Bit 2	Bit 1	Bit 0
Reserved								

Reserved	ID.12	ID.11	ID.10	ID.9	ID.8	ID.7	ID.6	ID.5
----------	-------	-------	-------	------	------	------	------	------

Table 32-15. TX/RX Identifier 4 (EFF); TWAI Address 0x50

Bit 31-8	Bit 7	Bit 6	Bit 5	Bit 4	Bit 3	Bit 2	Bit 1	Bit 0
Reserved	ID.4	ID.3	ID.2	ID.1	ID.0	X ¹	X ²	X ²

Notes:

1. Don't care. Recommended to be compatible with receive buffer (i.e., set to RTR) in case of using the self reception functionality (or together with self-test functionality).
2. Don't care. Recommended to be compatible with receive buffer (i.e., set to 0) in case of using the self reception functionality (or together with self-test functionality).

32.4.4.4 Frame Data

The Frame Data field contains the payloads of transmitted or received data frame, and can range from 0 to 8 bytes. The number of valid bytes should be equal to the DLC. However, if the DLC is larger than eight bytes, the number of valid bytes would still be limited to eight. Remote frames do not have data payloads, so their Frame Data fields will be unused.

For example, when transmitting a data frame with five bytes, the CPU should write five to the DLC field, and then write data to the corresponding register of the first to the fifth data field. Likewise, when the CPU receives a data frame with a DLC of five data bytes, only the first to the fifth data byte will contain valid payload data for the CPU to read.

32.4.5 Receive FIFO and Data Overruns

The Receive FIFO is a 64-byte internal buffer used to store received messages in First In First Out order. A single received message can occupy between 3 to 13 bytes of space in the Receive FIFO, and their endianness is identical to the register layout of the Receive Buffer registers. The Receive Buffer registers are mapped to the bytes of the first message in the Receive FIFO.

When the TWAI controller receives a message, it will increment the value of [TWAI_RX_MESSAGE_COUNTER](#) by 1, with a maximum of 64. If there is adequate space in the Receive FIFO, the message contents will be written into the Receive FIFO. Once a message has been read from the Receive Buffer, the [TWAI_RELEASE_BUF](#) bit should be set. This will decrement [TWAI_RX_MESSAGE_COUNTER](#) by 1 and free the space occupied by the first message in the Receive FIFO. The Receive Buffer will then map to the next message in the Receive FIFO.

A data overrun occurs when the TWAI controller receives a message, but the Receive FIFO lacks adequate free space to store the received message in its entirety (either due to the message contents being larger than the free space in the Receive FIFO, or the Receive FIFO being completely full).

When a data overrun occurs:

- The free space left in the Receive FIFO is filled with the partial contents of the overrun message. If the Receive FIFO is already full, then none of the overrun message's contents will be stored.
- When data in the Receive FIFO overruns for the first time, a Data Overrun Interrupt will be triggered.
- Each overrun message will still increment the [TWAI_RX_MESSAGE_COUNTER](#) up to a maximum of 64.

- The Receive FIFO will internally mark overrun messages as invalid. The `TWAI_MISS_ST` bit can be used to determine whether the message currently mapped to by the Receive Buffer is valid or overrun.

To clear an overrun Receive FIFO, the `TWAI_RELEASE_BUF` must be called repeatedly until `TWAI_RX_MESSAGE_COUNTER` is 0. This requires users to read all valid messages in the Receive FIFO and clear all overrun messages.

32.4.6 Acceptance Filter

The Acceptance Filter allows the TWAI controller to filter out received messages based on their ID (and optionally their first data byte and frame type). Only accepted messages are passed on to the Receive FIFO. The use of Acceptance Filters allows a more lightweight operation of the TWAI controller (e.g., less use of Receive FIFO, fewer Receive Interrupts) since the TWAI Controller only need to handle a subset of messages.

The Acceptance Filter configuration registers can only be accessed whilst the TWAI controller is in Reset Mode, since they share the same address spaces with the Transmit Buffer and Receive Buffer registers.

The configuration registers consist of a 32-bit Acceptance Code Value and a 32-bit Acceptance Mask Value. The Acceptance Code value specifies a bit pattern which each filtered bit of the message must match in order for the message to be accepted. The Acceptance Mask Value is able to mask out certain bits of the Code value (i.e., set as “Don’t Care” bits). Each filtered bit of the message must either match the acceptance code or be masked in order for the message to be accepted, as demonstrated in Figure 32-7.

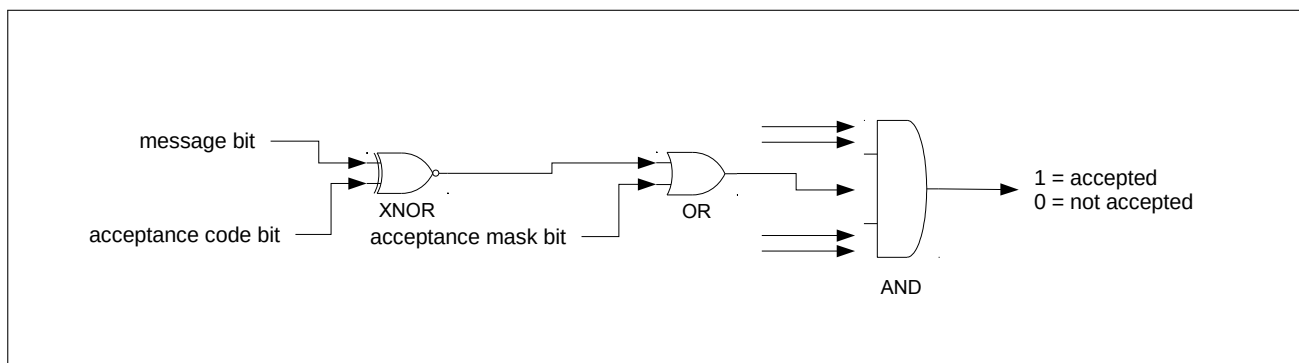

Figure 32-7. Acceptance Filter

The TWAI controller Acceptance Filter allows the 32-bit Acceptance Code and Mask Values to either define a single filter (i.e., Single Filter Mode), or two filters (i.e., Dual Filter Mode). How the Acceptance Filter interprets the 32-bit code and mask values is dependent on filter mode and the format of received messages (i.e., SFF or EFF).

32.4.6.1 Single Filter Mode

Single Filter Mode is enabled by setting the `TWAI_RX_FILTER_MODE` bit to 1. This will cause the 32-bit code and mask values to define a single filter. The single filter can filter the following bits of a data or remote frame:

- SFF
 - The entire 11-bit ID
 - RTR bit
 - Data byte 1 and Data byte 2

- EFF
 - The entire 29-bit ID
 - RTR bit

The following Figure 32-8 illustrates how the 32-bit code and mask values will be interpreted under Single Filter Mode.

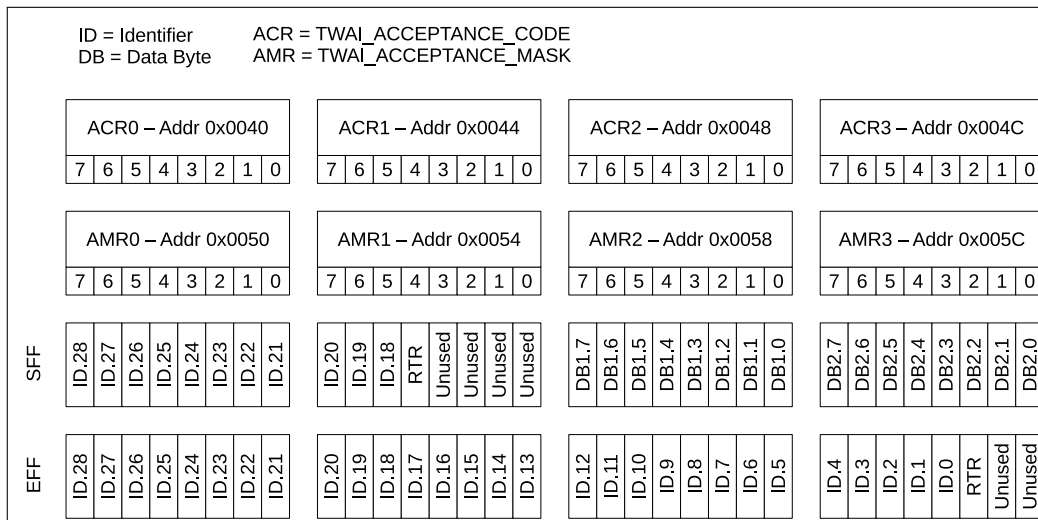

Figure 32-8. Single Filter Mode

32.4.6.2 Dual Filter Mode

Dual Filter Mode is enabled by clearing the [TWAI_RX_FILTER_MODE](#) bit to 0. This will cause the 32-bit code and mask values to define a two separate filters referred to as filter 1 or filter 2. Under Dual Filter Mode, a message will be accepted if it is accepted by one of the two filters.

The two filters can filter the following bits of a data or remote frame:

- SFF
 - The entire 11-bit ID
 - RTR bit
 - Data byte 1 (for filter 1 only)
- EFF
 - The first 16 bits of the 29-bit ID

The following Figure 32-9 illustrates how the 32-bit code and mask values will be interpreted in Dual Filter Mode.

32.4.7 Error Management

The TWAI protocol requires that each TWAI node maintains the Transmit Error Counter (TEC) and Receive Error Counter (REC). The value of both error counters determines the current error state of the TWAI controller (i.e., Error Active, Error Passive, Bus-Off). The TWAI controller stores the TEC and REC values in [TWAI_TX_ERR_CNT_REG](#) and [TWAI_RX_ERR_CNT_REG](#) respectively, and they can be read by the CPU

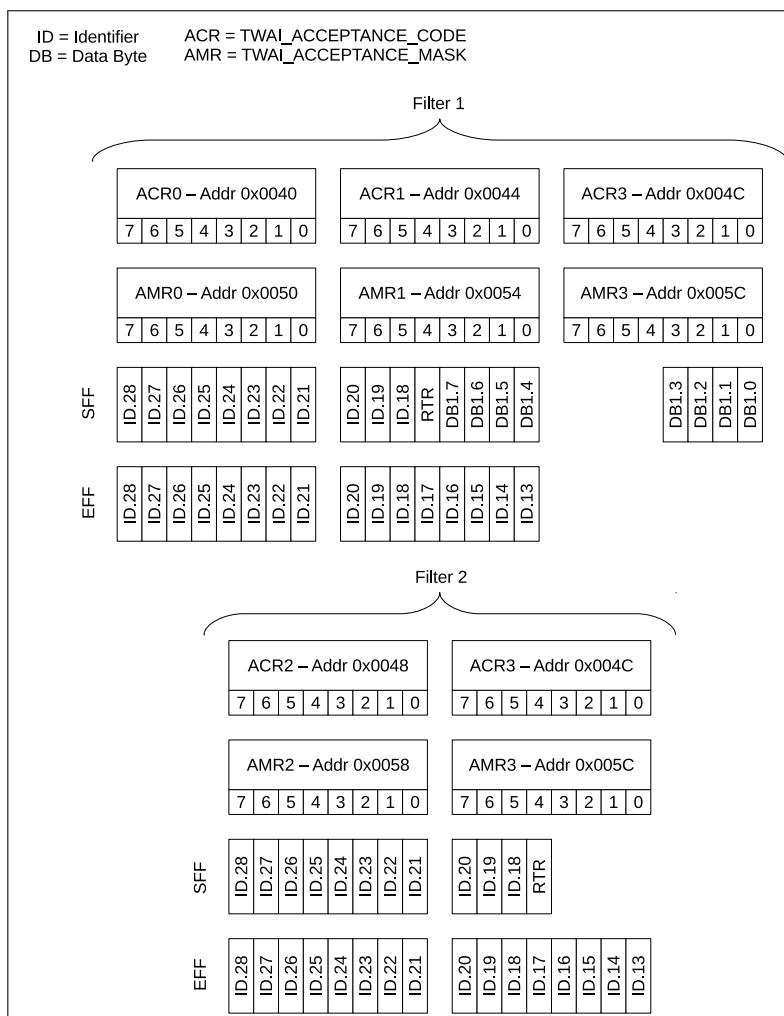

Figure 32-9. Dual Filter Mode

anytime. In addition to the error states, the TWAI controller also offers an Error Warning Limit (EWL) feature that can warn users of the occurrence of severe bus errors before the TWAI controller enters the Error Passive state.

The current error state of the TWAI controller is indicated via a combination of the following values and status bits: TEC, REC, `TWAI_ERR_ST`, and `TWAI_BUS_OFF_ST`. Certain changes to these values and bits will also trigger interrupts, thus allowing the users to be notified of error state transitions (see section 32.4.3). The following figure 32-10 shows the relation between the error states, values and bits, and error state related interrupts.

32.4.7.1 Error Warning Limit

The Error Warning Limit (EWL) is a configurable threshold value for the TEC and REC, which will trigger an interrupt when exceeded. The EWL is intended to serve as a warning about severe TWAI bus errors, and is triggered before the TWAI controller enters the Error Passive state. The EWL is configured in `TWAI_ERR_WARNING_LIMIT_REG` and can only be configured whilst the TWAI controller is in Reset Mode. The `TWAI_ERR_WARNING_LIMIT_REG` has a default value of 96.

When the values of TEC and/or REC are larger than or equal to the EWL value, the `TWAI_ERR_ST` bit is immediately set to 1. Likewise, when the values of both the TEC and REC are smaller than the EWL value, the `TWAI_ERR_ST` bit is immediately reset to 0. The Error Warning Interrupt is triggered whenever the value of the

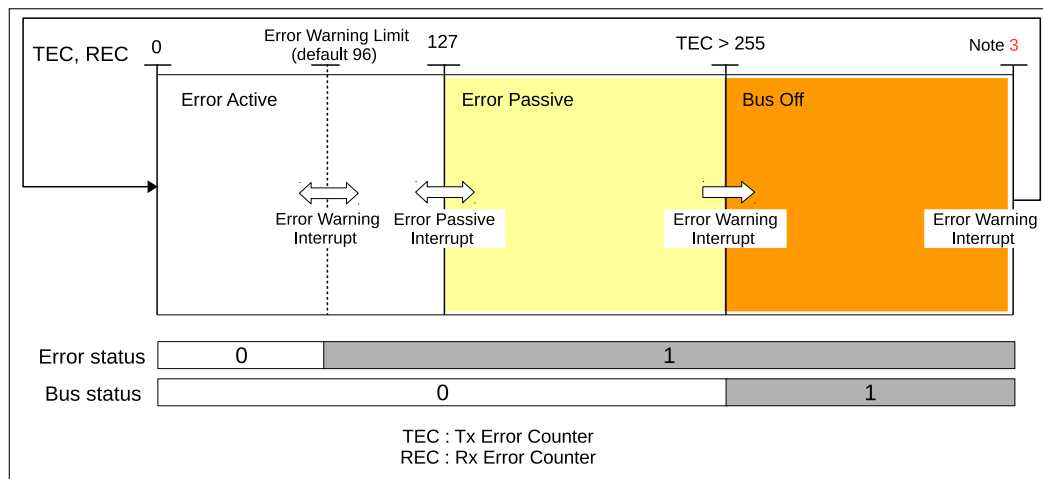

Figure 32-10. Error State Transition

[TWAI_ERR_ST](#) bit (or the [TWAI_BUS_OFF_ST](#)) changes.

32.4.7.2 Error Passive

The TWAI controller is in the Error Passive state when the TEC or REC value exceeds 127. Likewise, when both the TEC and REC are less than or equal to 127, the TWAI controller enters the Error Active state. The Error Passive Interrupt is triggered whenever the TWAI controller transitions from the Error Active state to the Error Passive state or vice versa.

32.4.7.3 Bus-Off and Bus-Off Recovery

The TWAI controller enters the Bus-Off state when the TEC value exceeds 255. On entering the Bus-Off state, the TWAI controller will automatically do the following:

- Set REC to 0
- Set TEC to 127
- Set the [TWAI_BUS_OFF_ST](#) bit to 1
- Enter Reset Mode

The Error Warning Interrupt is triggered whenever the value of the [TWAI_BUS_OFF_ST](#) bit (or the [TWAI_ERR_ST](#) bit) changes.

To return to the Error Active state, the TWAI controller must undergo Bus-Off Recovery. Bus-Off Recovery requires the TWAI controller to observe 128 occurrences of 11 consecutive recessive bits on the bus. To initiate Bus-Off Recovery (after entering the Bus-Off state), the TWAI controller should enter Operation Mode by setting the [TWAI_RESET_MODE](#) bit to 0. The TEC tracks the progress of Bus-Off Recovery by decrementing the TEC each time when the TWAI controller observes 11 consecutive recessive bits. When Bus-Off Recovery has completed (i.e., TEC has decremented from 127 to 0), the [TWAI_BUS_OFF_ST](#) bit will automatically be reset to 0, thus triggering the Error Warning Interrupt.

32.4.8 Error Code Capture

The Error Code Capture (ECC) feature allows the TWAI controller to record the error type and bit position of a TWAI bus error in the form of an error code. Upon detecting a TWAI bus error, the Bus Error Interrupt is triggered and the error code is recorded in `TWAI_ERR_CODE_CAP_REG`. Subsequent bus errors will trigger the Bus Error Interrupt, but their error codes will not be recorded until the current error code is read from the `TWAI_ERR_CODE_CAP_REG`.

The following Table 32-16 shows the fields of the `TWAI_ERR_CODE_CAP_REG`:

Table 32-16. Bit Information of `TWAI_ERR_CODE_CAP_REG` (0x30)

Bit 31-8	Bit 7	Bit 6	Bit 5	Bit 4	Bit 3	Bit 2	Bit 1	Bit 0
Reserved	ERRC.1 ¹	ERRC.0 ¹	DIR ²	SEG.4 ³	SEG.3 ³	SEG.2 ³	SEG.1 ³	SEG.0 ³

Notes:

- ERRC: The Error Code (ERRC) indicates the type of bus error: 00 for bit error, 01 for format error, 10 for stuff error, and 11 for other types of error.
- DIR: The Direction (DIR) indicates whether the TWAI controller was transmitting or receiving when the bus error occurred: 0 for transmitter, 1 for receiver.
- SEG: The Error Segment (SEG) indicates the segment of the TWAI message at which the bus error occurred.

The following Table 32-17 shows how to interpret the SEG.0 to SEG.4 bits.

Table 32-17. Bit Information of Bits SEG.4 - SEG.0

Bit SEG.4	Bit SEG.3	Bit SEG.2	Bit SEG.1	Bit SEG.0	Description
0	0	0	1	1	start of frame
0	0	0	1	0	ID.28 ~ ID.21
0	0	1	1	0	ID.20 ~ ID.18
0	0	1	0	0	bit SRTR
0	0	1	0	1	bit IDE
0	0	1	1	1	ID.17 ~ ID.13
0	1	1	1	1	ID.12 ~ ID.5
0	1	1	1	0	ID.4 ~ ID.0
0	1	1	0	0	bit RTR
0	1	1	0	1	reserved bit 1
0	1	0	0	1	reserved bit 0
0	1	0	1	1	data length code
0	1	0	1	0	data field
0	1	0	0	0	CRC sequence
1	1	0	0	0	CRC delimiter
1	1	0	0	1	ACK slot
1	1	0	1	1	ACK delimiter
1	1	0	1	0	end of frame
1	0	0	1	0	intermission

Cont'd on next page

Table 32-17 – cont'd from previous page

Bit SEG.4	Bit SEG.3	Bit SEG.2	Bit SEG.1	Bit SEG.0	Description
1	0	0	0	1	active error flag
1	0	1	1	0	passive error flag
1	0	0	1	1	tolerate dominant bits
1	0	1	1	1	error delimiter
1	1	1	0	0	overload flag

Notes:

- Bit SRTR: under Standard Frame Format.
- Bit IDE: Identifier Extension Bit, 0 for Standard Frame Format.

32.4.9 Arbitration Lost Capture

The Arbitration Lost Capture (ALC) feature allows the TWAI controller to record the bit position where it loses arbitration. When the TWAI controller loses arbitration, the bit position is recorded in `TWAI_ARB_LOST_CAP_REG` and the Arbitration Lost Interrupt is triggered.

Subsequent losses in arbitration will trigger the Arbitration Lost Interrupt, but will not be recorded in `TWAI_ARB_LOST_CAP_REG` until the current Arbitration Lost Capture is read from the `TWAI_ERR_CODE_CAP_REG`.

Table 32-18 illustrates bits and fields of `TWAI_ERR_CODE_CAP_REG` whilst Figure 32-11 illustrates the bit positions of a TWAI message.

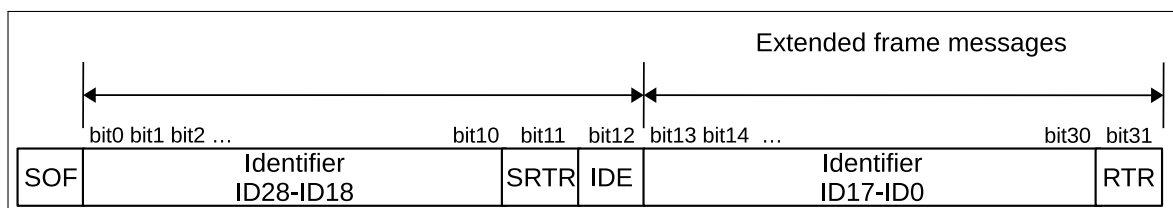

Figure 32-11. Positions of Arbitration Lost Bits

Table 32-18. Bit Information of `TWAI_ARB_LOST_CAP_REG` (0x2c)

Bit 31-5	Bit 4	Bit 3	Bit 2	Bit 1	Bit 0
Reserved	BITNO.4 ¹	BITNO.3 ¹	BITNO.2 ¹	BITNO.1 ¹	BITNO.0 ¹

Notes:

- BITNO: Bit Number (BITNO) indicates the nth bit of a TWAI message where arbitration was lost.

32.4.10 Transceiver Auto-Standby

It is common for TWAI transceivers to support a standby mode to lower power consumption. TWAI transceivers will generally expose a standby signal that is asserted by the connected TWAI controller, thus allowing the controller to place the transceiver into standby when appropriate (e.g., when the bus will be idle for an extended period of time). Transceivers will exit standby mode if the controller de-asserts the standby signal, or if the transceiver detects bus activity (also known as a wake-up feature).

ESP32-C6's TWAI controller supports both hardware control (i.e., automatic) and software control (i.e., manual)

of the standby signal to control the switching of TWAI transceivers connected to the chip. When hardware controlled, the TWAI controller will automatically assert the standby signal when the bus remains idle for longer than a configurable amount of time. When software controlled, the standby signal can be manually asserted/de-asserted directly by software.

- Hardware output:
 1. Set the [TWAI_HW_STANDBY_EN](#) field in the [TWAI_HW_CFG_REG](#) register to enable standby function for hardware.
 2. Configure the [TWAI_HW_STANDB_CNT_REG](#) register. This register indicates the time required before hardware trigger the standby signal after entering idle status, in which the value indicates the number of cycles of the TWAI controller operating clock (40 MHz by default).
- Software output:
 1. Set the [TWAI_SW_STANDBY_EN](#) field in the [TWAI_SW_STANDBY_CFG_REG](#) register to generate standby signal in the TWAI controller.

The standby signal generated using either of the above methods will be pulled down (cleared) when either of the following conditions is met:

1. The standby signal will be automatically cleared when the TWAI controller exits the idle status.
2. Users can also pull down the standby signal by setting the [TWAI_SW_STANDBY_CLR](#) field in the [TWAI_SW_STANDBY_CFG_REG](#) register.

32.5 Register Summary

'|' here means separate line to distinguish between TWAI working modes discussed in Section 32.4.1 *Modes*. The left describes the access in Operation Mode. The right belongs to Reset Mode and is marked in red. The addresses in this section are relative to Two-wire Automotive Interface base address provided in Table 5-2 in Chapter 5 *System and Memory*.

The abbreviations given in Column **Access** are explained in Section *Access Types for Registers*.

Name	Description	Address	Access
Configuration Registers			
TWAI_MODE_REG	Mode Register	0x0000	R/W
TWAI_BUS_TIMING_0_REG	Bus Timing Register 0	0x0018	RO R/W
TWAI_BUS_TIMING_1_REG	Bus Timing Register 1	0x001C	RO R/W
TWAI_ERR_WARNING_LIMIT_REG	Error Warning Limit Register	0x0034	RO R/W
TWAI_DATA_0_REG	Data Register 0	0x0040	WO R/W
TWAI_DATA_1_REG	Data Register 1	0x0044	WO R/W
TWAI_DATA_2_REG	Data Register 2	0x0048	WO R/W
TWAI_DATA_3_REG	Data Register 3	0x004C	WO R/W
TWAI_DATA_4_REG	Data Register 4	0x0050	WO R/W
TWAI_DATA_5_REG	Data Register 5	0x0054	WO R/W
TWAI_DATA_6_REG	Data Register 6	0x0058	WO R/W
TWAI_DATA_7_REG	Data Register 7	0x005C	WO R/W
TWAI_DATA_8_REG	Data Register 8	0x0060	WO RO
TWAI_DATA_9_REG	Data Register 9	0x0064	WO RO
TWAI_DATA_10_REG	Data Register 10	0x0068	WO RO
TWAI_DATA_11_REG	Data Register 11	0x006C	WO RO
TWAI_DATA_12_REG	Data Register 12	0x0070	WO RO
TWAI_CLOCK_DIVIDER_REG	Clock Divider Register	0x007C	varies
TWAI_SW_STANDBY_CFG_REG	Software Standby Register	0x0080	R/W R/W
TWAI_HW_CFG_REG	Software Standby Register	0x0084	R/W R/W
TWAI_HW_STANDBY_CNT_REG	Standby Time Length Register	0x0088	R/W R/W
TWAI_IDLE_INTR_CNT_REG	Idle Status Time Length Register	0x008C	R/W R/W
Control Registers			
TWAI_CMD_REG	Command Register	0x0004	WO
Status Register			
TWAI_STATUS_REG	Status Register	0x0008	RO
TWAI_ARB_LOST_CAP_REG	Arbitration Lost Capture Register	0x002C	RO
TWAI_ERR_CODE_CAP_REG	Error Code Capture Register	0x0030	RO
TWAI_RX_ERR_CNT_REG	Receive Error Counter Register	0x0038	RO R/W
TWAI_TX_ERR_CNT_REG	Transmit Error Counter Register	0x003C	RO R/W
TWAI_RX_MESSAGE_CNT_REG	Receive Message Counter Register	0x0074	RO
Interrupt Registers			
TWAI_INT_ST_REG	Interrupt Register	0x000C	RO
TWAI_INT_ENA_REG	Interrupt Enable Register	0x0010	R/W

32.6 Registers

'|' here means separate line. The left describes the access in Operation Mode. The right belongs to Reset Mode with red color. The addresses in this section are relative to Two-wire Automotive Interface base address (each TWAI 0 and TWAI 1 has an individual base address) provided in Table 5-2 in Chapter 5 *System and Memory*.

Register 32.1. TWAI_MODE_REG (0x0000)

(reserved)																TWAI_RX_FILTER_MODE TWAI_SELF_TEST_MODE TWAI_LISTEN_ONLY_MODE TWAI_RESET_MODE				
31															4	3	2	1	0	Reset
0 0																0	0	0	1	

TWAI_RESET_MODE Configures the Operation mode of the TWAI Controller.

- 0: Operation mode
 - 1: Reset mode
- (R/W)

TWAI_LISTEN_ONLY_MODE Configures whether to enter the Listen-only mode.

- 0: No effect
 - 1: Listen-only mode. In this mode, the nodes will only receive messages from the bus, without generating the acknowledge signal or updating the RX error counter.
- (R/W)

TWAI_SELF_TEST_MODE Configures whether to enter the Self-test mode.

- 0: No effect
 - 1: Enter the Self-test mode. In this mode, the TX nodes can perform a successful transmission without receiving the acknowledge signal. This mode is often used to test a single node with the self-reception request command.
- (R/W)

TWAI_RX_FILTER_MODE Configures the filter mode.

- 0: Dual-filter mode
 - 1: Single-filter mode
- (R/W)

Register 32.2. TWAI_BUS_TIMING_0_REG (0x0018)

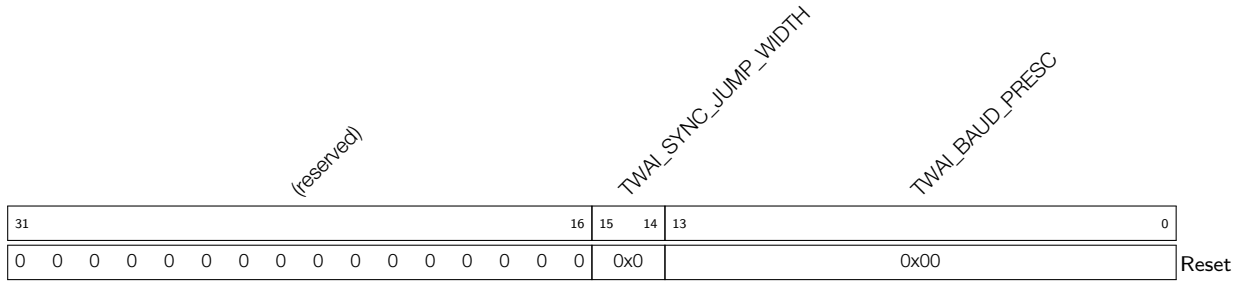

TWAI_BAUD_PRESC Configures baud rate prescaler value, determining the frequency dividing ratio.

0: Low

1: High

(RO | R/W)

TWAI_SYNC_JUMP_WIDTH Configures Synchronization Jump Width (SJW), ranging from 1 ~ 4 T_q wide. (RO | R/W)

Register 32.3. TWAI_BUS_TIMING_1_REG (0x001C)

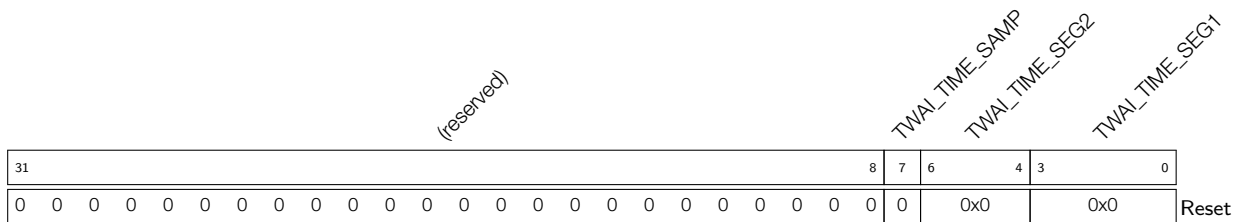

TWAI_TIME_SEG1 Configures the width of PBS1. (RO | R/W)

TWAI_TIME_SEG2 Configures the width of PBS2. (RO | R/W)

TWAI_TIME_SAMP Configures the number of sample points.

0: The bus is sampled once

1: The bus is sampled three times

(RO | R/W)

Register 32.4. TWAI_ERR_WARNING_LIMIT_REG (0x0034)

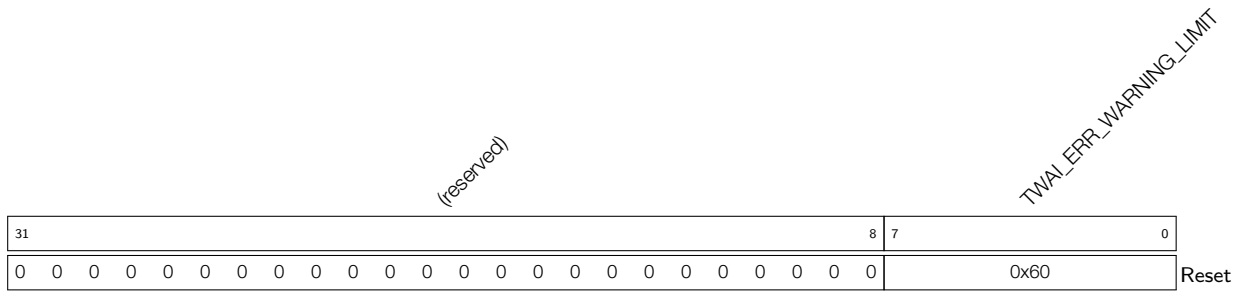

TWAI_ERR_WARNING_LIMIT Configures error warning threshold. In the case when any of an error counter value exceeds the threshold, or all the error counter values are below the threshold, an error warning interrupt will be triggered. Valid only when the enable signal is 1. (RO | R/W)

Register 32.5. TWAI_DATA_0_REG (0x0040)

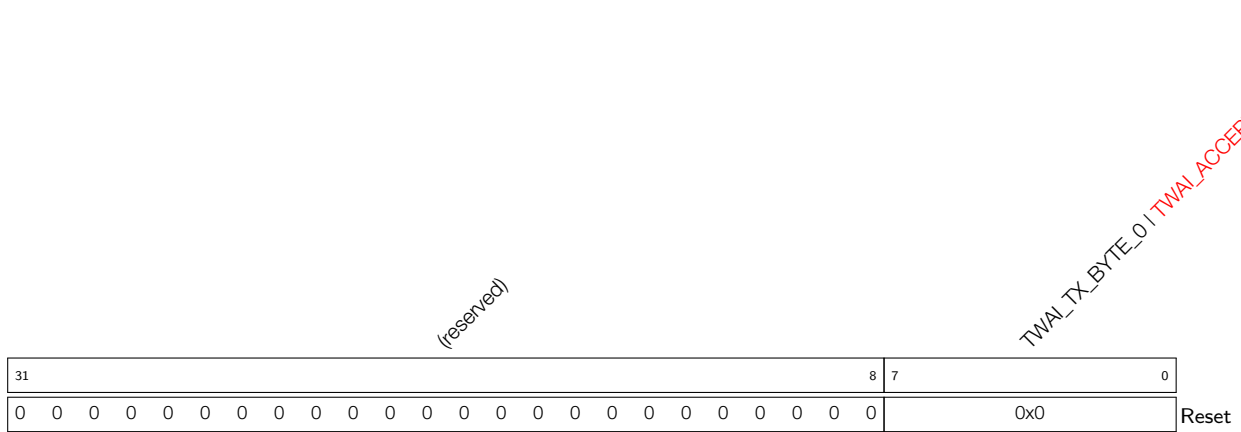

TWAI_TX_BYTE_0 Configures the 0th byte information of the data to be transmitted in Operation mode. (WO)

TWAI_ACCEPTANCE_CODE_0 Configures the 0th byte of the filter code in Reset mode. (R/W)

Register 32.6. TWAI_DATA_1_REG (0x0044)

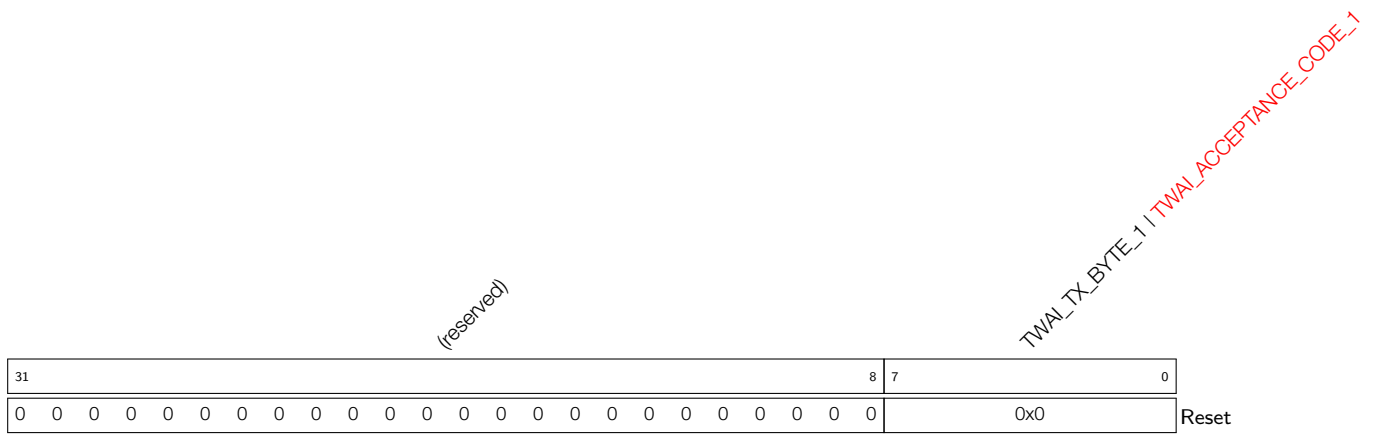

TWAI_TX_BYTE_1 Configures the 1st byte information of the data to be transmitted in Operation mode. (WO)

TWAI_ACCEPTANCE_CODE_1 Configures the 1st byte of the filter code in Reset mode. (R/W)

Register 32.7. TWAI_DATA_2_REG (0x0048)

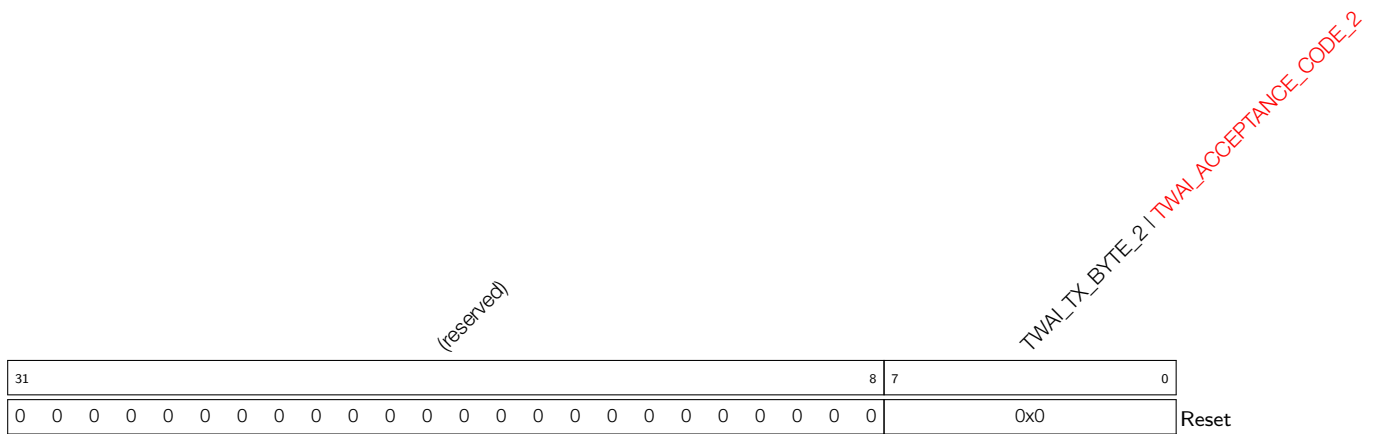

TWAI_TX_BYTE_2 Configures the 2nd byte information of the data to be transmitted in Operation mode. (WO)

TWAI_ACCEPTANCE_CODE_2 Configures the 2nd byte of the filter code in Reset mode. (R/W)

Register 32.8. TWAI_DATA_3_REG (0x004C)

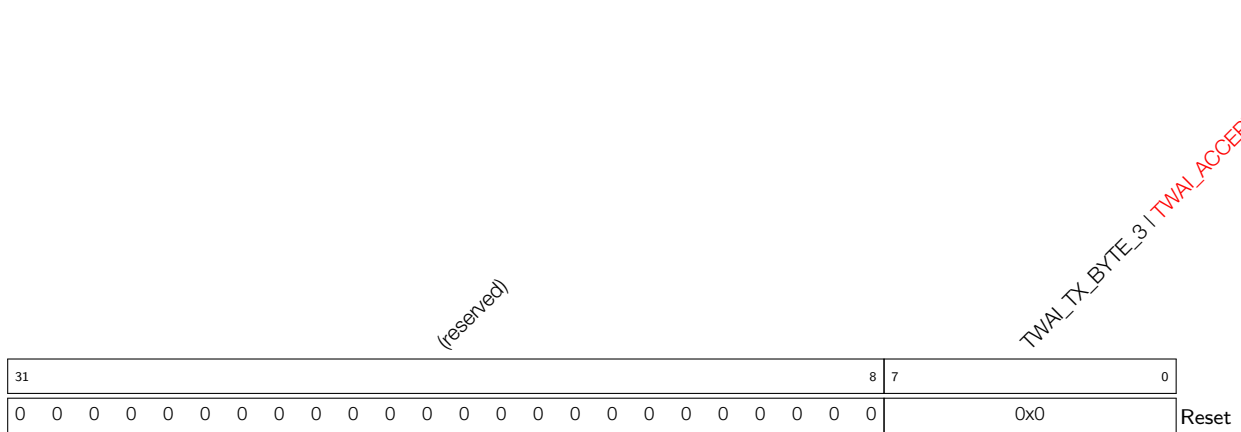

TWAI_TX_BYTE_3 Configures the 3rd byte information of the data to be transmitted in Operation mode. (WO)

TWAI_ACCEPTANCE_CODE_3 Configures the 3rd byte of the filter code in Reset mode. (R/W)

Register 32.9. TWAI_DATA_4_REG (0x0050)

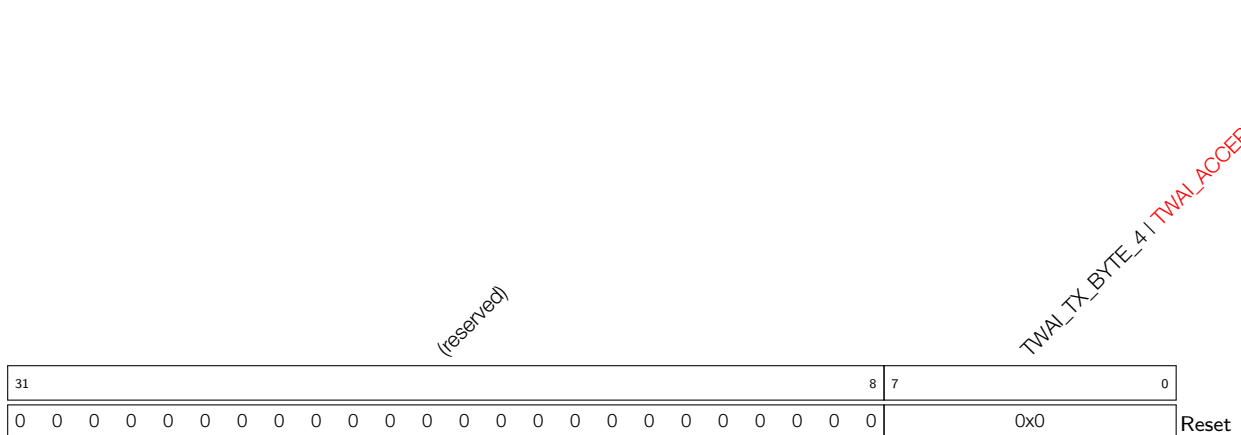

TWAI_TX_BYTE_4 Configures the 4th byte information of the data to be transmitted in Operation mode. (WO)

TWAI_ACCEPTANCE_MASK_0 Configures the 0th byte of the filter code in Reset mode.

- 1: nihao
 - 2: world
 - 3: success
- (R/W)

Register 32.10. TWAI_DATA_5_REG (0x0054)

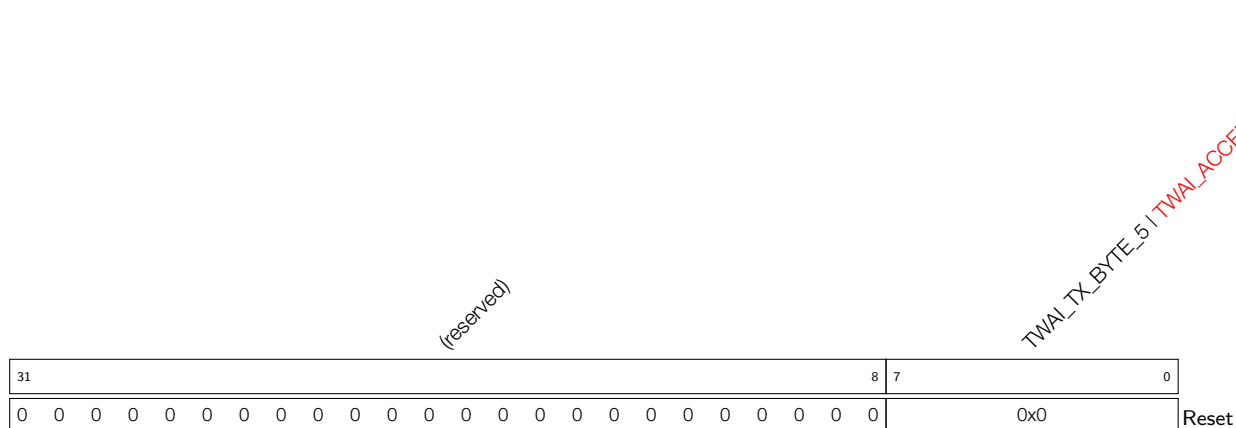

TWAI_TX_BYTE_5 Configures the 5th byte information of the data to be transmitted in Operation mode. (WO)

TWAI_ACCEPTANCE_MASK_1 Configures the 1st byte of the filter code in Reset mode. (R/W)

Register 32.11. TWAI_DATA_6_REG (0x0058)

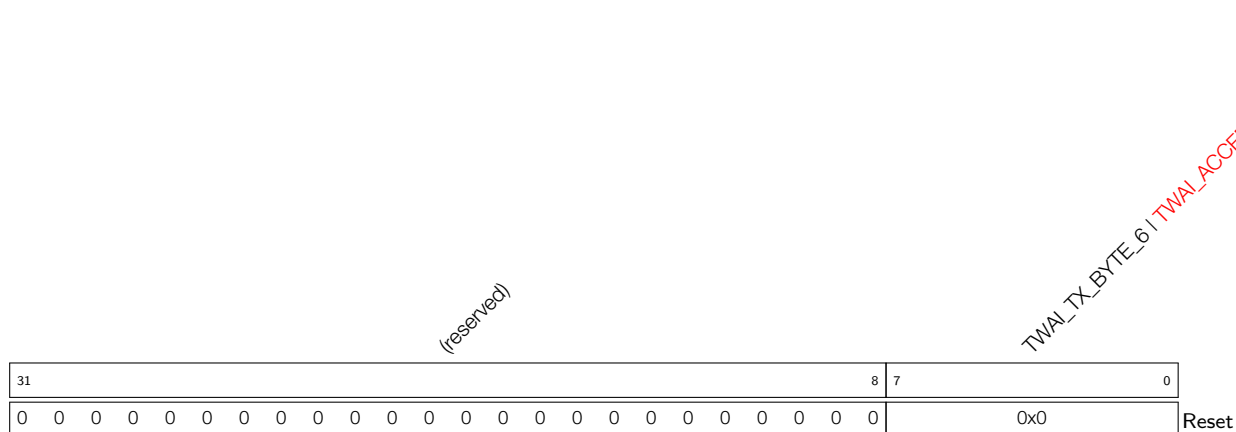

TWAI_TX_BYTE_6 Configures the 6th byte information of the data to be transmitted in Operation mode. (WO)

TWAI_ACCEPTANCE_MASK_2 Configures the 2nd byte of the filter code in Reset mode. (R/W)

Register 32.12. TWAI_DATA_7_REG (0x005C)

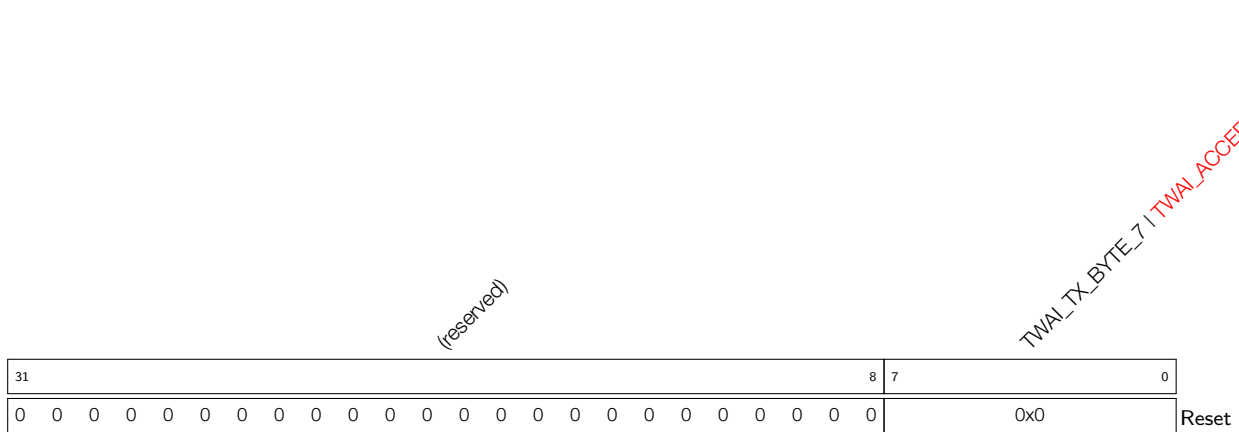

TWAI_TX_BYTE_7 Configures the 7th byte information of the data to be transmitted in Operation mode. (WO)

TWAI_ACCEPTANCE_MASK_3 Configures the 3rd byte of the filter code in Reset mode. (R/W)

Register 32.13. TWAI_DATA_8_REG (0x0060)

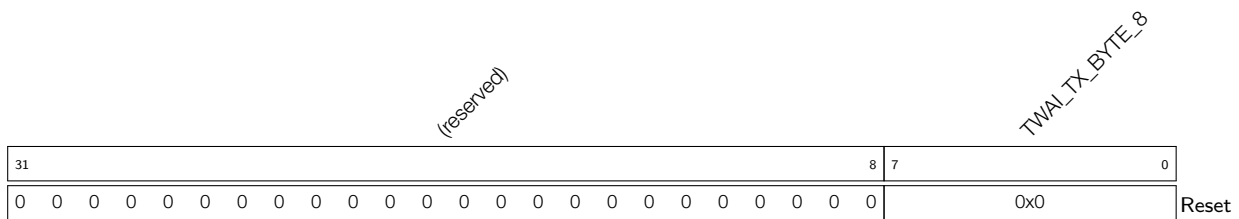

TWAI_TX_BYTE_8 Configures the 8th byte information of the data to be transmitted in Operation mode. (WO)

Register 32.14. TWAI_DATA_9_REG (0x0064)

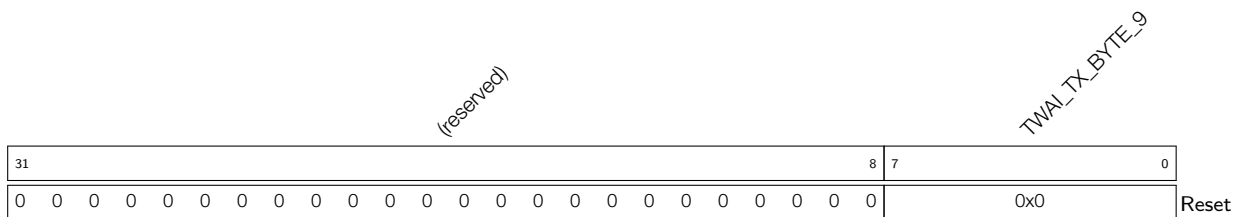

TWAI_TX_BYTE_9 Configures the 9th byte information of the data to be transmitted in Operation mode. (WO)

Register 32.15. TWAI_DATA_10_REG (0x0068)

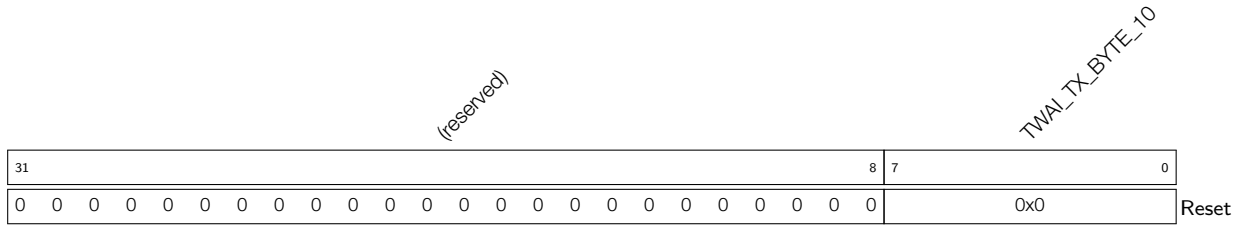

TWAI_TX_BYTE_10 Configures the 10th byte information of the data to be transmitted in Operation mode. (WO)

Register 32.16. TWAI_DATA_11_REG (0x006C)

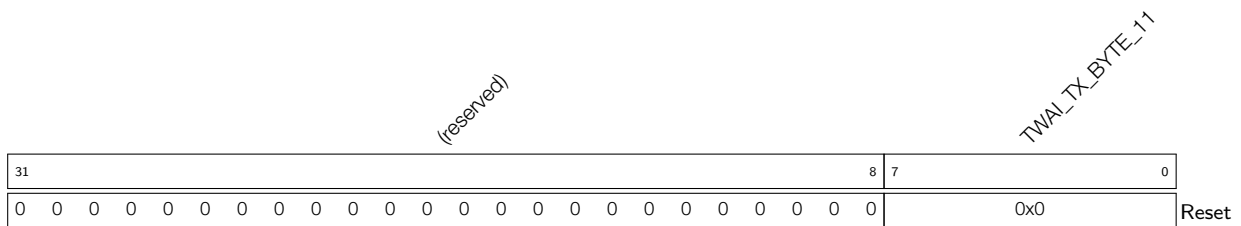

TWAI_TX_BYTE_11 Configures the 11th byte information of the data to be transmitted in Operation mode. (WO)

Register 32.17. TWAI_DATA_12_REG (0x0070)

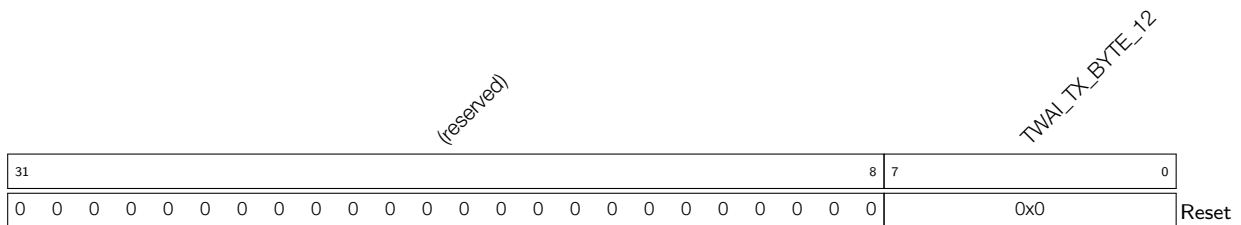

TWAI_TX_BYTE_12 Configures the 12th byte information of the data to be transmitted in Operation mode. (WO)

Register 32.18. TWAI_CLOCK_DIVIDER_REG (0x007C)

(reserved)										TWAI_CLOCK_OFF		TWAI_CD		
31										9	8	7	0	
0 0 0 0 0 0 0 0 0 0										0		0x0		Reset

TWAI_CD Configures the divisor of the external CLKOUT pin. (R/W)

TWAI_CLOCK_OFF Configures whether or not to enable the external CLKOUT pin in Reset mode.

0: Enable the external CLKOUT pin

1: Disable the external CLKOUT pin

(RO | R/W)

Register 32.19. TWAI_SW_STANDBY_CFG_REG (0x0080)

(reserved)										TWAI_SW_STANDBY_CLR		TWAI_SW_STANDBY_EN		
31										2	1	0		
0x0										0		0		Reset

TWAI_SW_STANDBY_CLR Configures whether to clear standby signals with software.

0: No effect

1: Clear standby signals

(R/W | R/W)

TWAI_SW_STANDBY_EN Configures whether to set standby signals with software.

0: No effect

1: Set standby signals

(R/W | R/W)

Register 32.20. TWAI_HW_CFG_REG (0x0084)



TWAI_HW_STANDBY_EN Configures whether to enable the standby function for hardware.

0: No effect

1: Enable the standby function for hardware

(R/W | R/W)

Register 32.21. TWAI_HW_STANDBY_CNT_REG (0x0070)

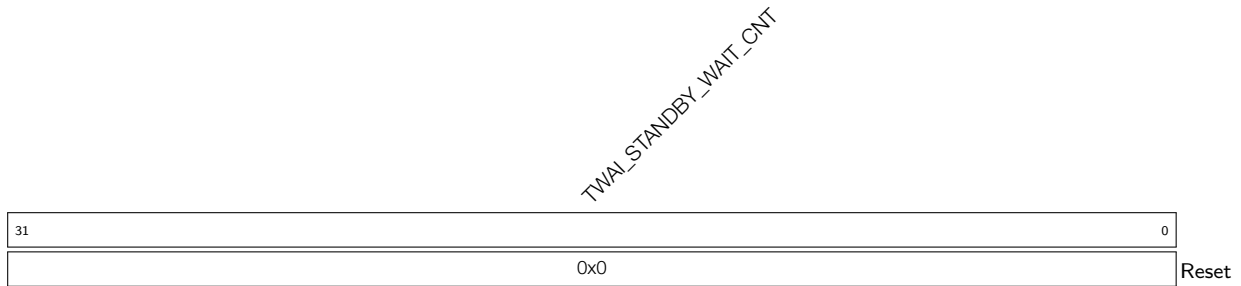

TWAI_STANDBY_WAIT_CNT Configures the time required before hardware triggers the standby signal after entering idle status. (R/W | R/W)

Measurement unit: TWAI controller clock cycles.

Register 32.22. TWAI_IDLE_INTR_CNT_REG (0x0070)

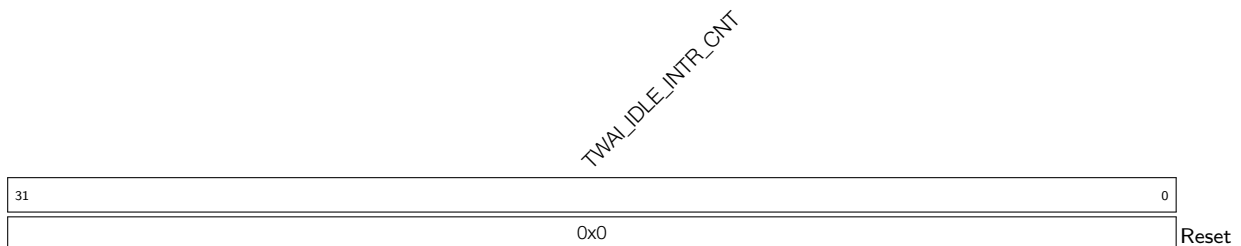

TWAI_IDLE_INTR_CNT Configures the time required before hardware generates the bus idle status interrupt signal after entering idle status. (R/W | R/W)

Measurement unit: TWAI controller clock cycles.

Register 32.23. TWAI_CMD_REG (0x0004)

(reserved)																TWAI_SELF_RX_REQ TWAI_CLR_OVERRUN TWAI_RELEASE_BUF TWAI_ABORT_TX TWAI_TX_REQ					
31															5	4	3	2	1	0	Reset
0																0	0	0	0	0	

TWAI_TX_REQ Configures whether to drive nodes to start transmission.

- 0: No effect
 - 1: Drive nodes to start transmission
- (WO)

TWAI_ABORT_TX Configures whether to cancel a pending transmission request.

- 0: No effect
 - 1: Cancel a pending transmission request
- (WO)

TWAI_RELEASE_BUF Configures whether to release the RX buffer.

- 0: No effect
 - 1: Release the RX buffer
- (WO)

TWAI_CLR_OVERRUN Configures whether to clear the data overrun status bit.

- 0: No effect
 - 1: Clear the data overrun status bit
- (WO)

TWAI_SELF_RX_REQ Configures whether to allow a message be transmitted and received simultaneously.

- 0: No effect
 - 1: Allow a message to be transmitted and received simultaneously
- (WO)

Register 32.24. TWAI_STATUS_REG (0x0008)

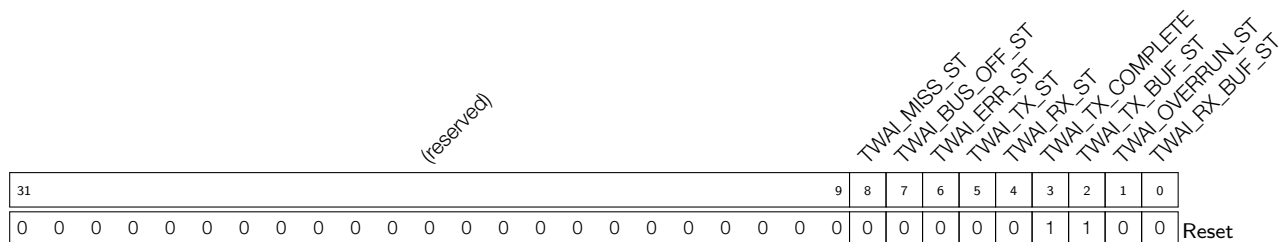

TWAI_RX_BUF_ST Represents whether or not the RX buffer is empty.
 0: Empty
 1: Not empty, with at least one received data packet.
 (RO)

TWAI_OVERRUN_ST Represents whether or not the RX FIFO is full.
 0: Not full
 1: Full, and data overrun has occurred
 (RO)

TWAI_TX_BUF_ST Represents whether or not the TX buffer is empty.
 0: Not empty
 1: Empty, and the CPU may write a message into it
 (RO)

TWAI_TX_COMPLETE Represents whether or not the TWAI controller has received a packet from the bus.
 0: Not received
 1: Received
 (RO)

TWAI_RX_ST Represents whether or not the TWAI Controller is receiving a message from the bus.
 0: Not receiving
 1: Receiving
 (RO)

TWAI_TX_ST Represents whether or not the TWAI Controller is transmitting a message to the bus.
 0: Not transmitting
 1: Transmitting
 (RO)

TWAI_ERR_ST Represents at least one of the RX/TX error counter has reached or exceeded the value set in register [TWAI_ERR_WARNING_LIMIT_REG](#). (RO)

TWAI_BUS_OFF_ST Represents whether or not the TWAI Controller involves in bus activities in bus-off status.
 0: Involved
 1: No longer involved
 (RO)

TWAI_MISS_ST Represents whether or not the data packet in the RX FIFO is complete.
 0: The current packet is complete
 1: The current packet is missing
 (RO)

Register 32.25. TWAI_ARB_LOST_CAP_REG (0x002C)

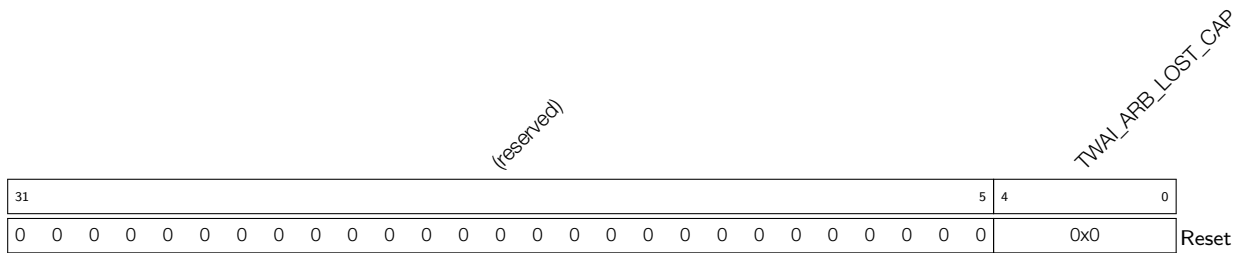

TWAI_ARB_LOST_CAP Represents the bit position of lost arbitration. (RO)

Register 32.26. TWAI_ERR_CODE_CAP_REG (0x0030)

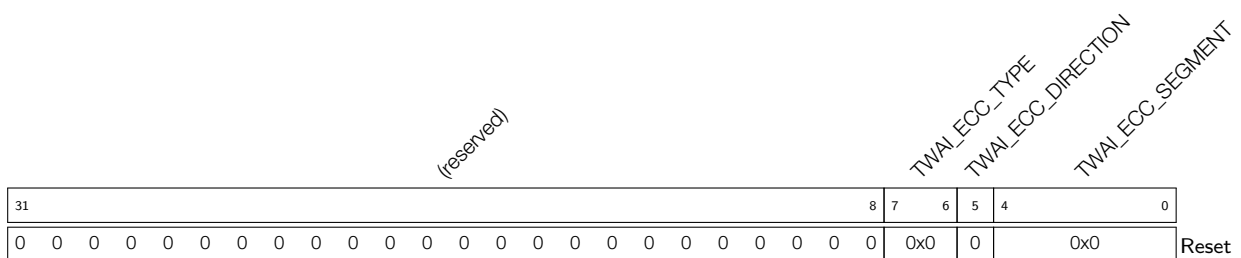

TWAI_ECC_SEGMENT Represents the location of errors, see Table 32-16 for details. (RO)

TWAI_ECC_DIRECTION Represents transmission direction of the node when an error occurs.

0: Error occurs when transmitting a message

1: Error occurs when receiving a message

(RO)

TWAI_ECC_TYPE Represents error types.

0: Bit error

1: Form error

2: Stuff error

3: Others

(RO)

Register 32.27. TWAI_RX_ERR_CNT_REG (0x0038)

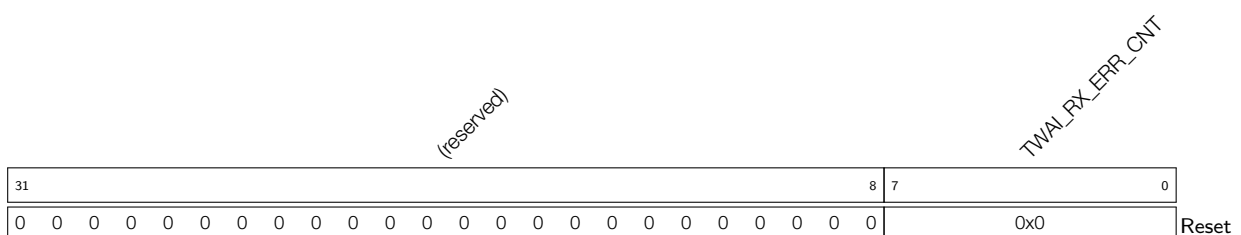

TWAI_RX_ERR_CNT The RX error counter register, reflects value changes in reception status. (RO | R/W)

Register 32.28. TWAI_TX_ERR_CNT_REG (0x003C)

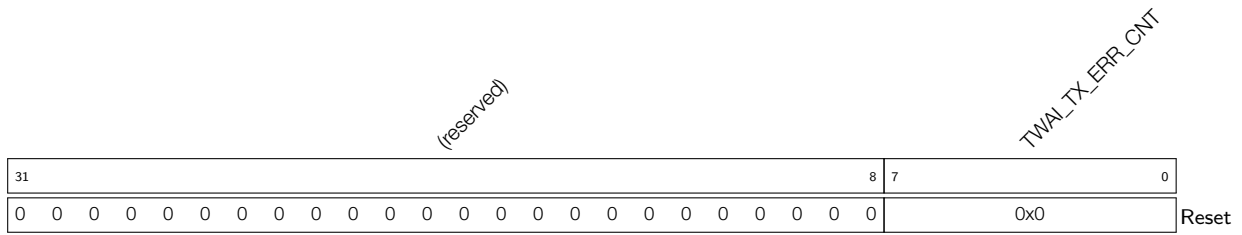

TWAI_TX_ERR_CNT The TX error counter register, reflects value changes in transmission status. (RO
I R/W)

Register 32.29. TWAI_RX_MESSAGE_CNT_REG (0x0074)

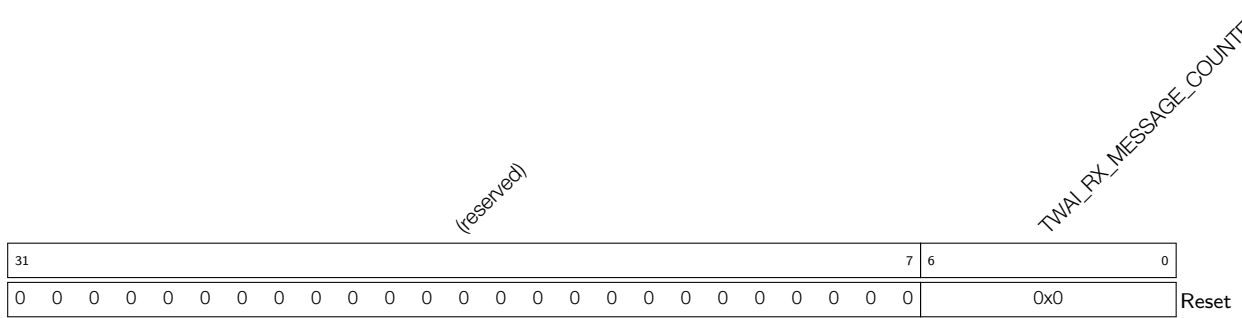

TWAI_RX_MESSAGE_COUNTER Represents the number of messages available within the RX FIFO. (RO)

Register 32.30. TWAI_INT_ST_REG (0x000C)

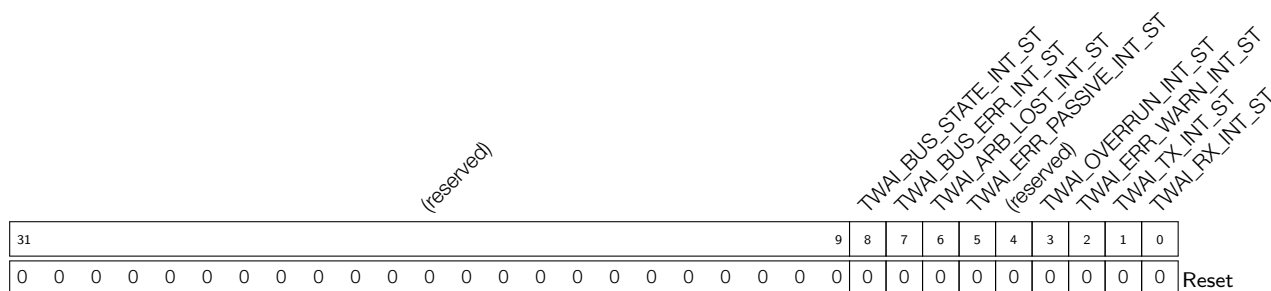

- TWAI_RX_INT_ST** The masked interrupt status of TWAI_RX_INT. (RO)
- TWAI_TX_INT_ST** The masked interrupt status of TWAI_TX_INT. (RO)
- TWAI_ERR_WARN_INT_ST** The masked interrupt status of TWAI_ERR_WARN_INT. (RO)
- TWAI_OVERRUN_INT_ST** The masked interrupt status of TWAI_OVERRUN_INT. (RO)
- TWAI_ERR_PASSIVE_INT_ST** The masked interrupt status of TWAI_ERR_PASSIVE_INT. (RO)
- TWAI_ARB_LOST_INT_ST** The masked interrupt status of TWAI_ARB_LOST_INT. (RO)
- TWAI_BUS_ERR_INT_ST** The masked interrupt status of TWAI_BUS_ERR_INT. (RO)
- TWAI_BUS_STATE_INT_ST** The masked interrupt status of TWAI_BUS_STATE_INT. (RO)

Register 32.31. TWAI_INT_ENA_REG (0x0010)

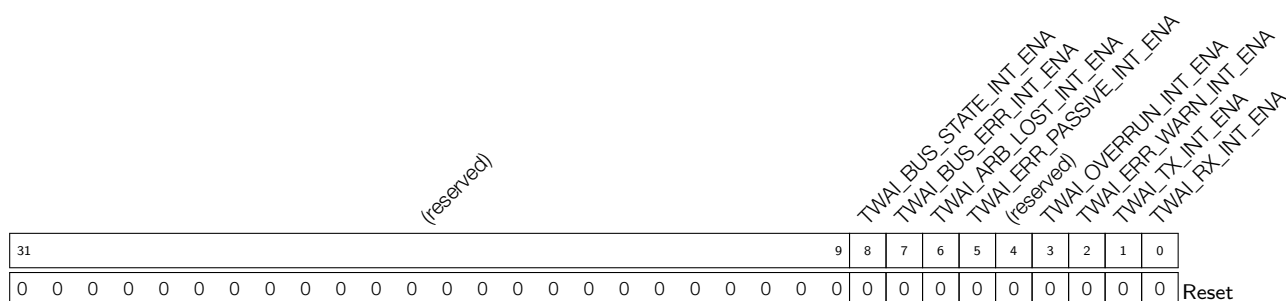

- TWAI_RX_INT_ENA** Write 1 to enable the receive interrupt. (R/W)
- TWAI_TX_INT_ENA** Write 1 to enable the transmit interrupt. (R/W)
- TWAI_ERR_WARN_INT_ENA** Write 1 to enable the error warning interrupt. (R/W)
- TWAI_OVERRUN_INT_ENA** Write 1 to enable the data overrun interrupt. (R/W)
- TWAI_ERR_PASSIVE_INT_ENA** Write 1 to enable the error passive interrupt. (R/W)
- TWAI_ARB_LOST_INT_ENA** Write 1 to enable the arbitration lost interrupt. (R/W)
- TWAI_BUS_ERR_INT_ENA** Write 1 to enable the bus error interrupt. (R/W)
- TWAI_BUS_STATE_INT_ENA** Write 1 to enable the bus state interrupt. (R/W)

33 SDIO 2.0 Slave Controller (SDIO)

33.1 Overview

The ESP32-C6 features hardware support for the Secure Digital Input/Output (SDIO) device interface that conforms to the SDIO Specification V2.00. This allows an SDIO host to access the ESP32-C6 via an SDIO bus protocol.

The SDIO host can read ESP32-C6 SDIO interface registers directly or access shared memory via the Direct Memory Access (DMA) engine, thus reducing processor's overhead while keeping high performance.

33.2 Features

The SDIO 2.0 Slave Controller has the following features:

- Compatible with SD Physical Layer Specification V2.00 and SDIO V2.00 specifications
- Support for two IO functions (except function 0)
- Support for SPI, 1-bit SDIO, and 4-bit SDIO transfer modes
- Clock range of 0 ~ 50 MHz
- Configurable sample and drive clock edge
- Integrated and SDIO-accessible registers for information interaction
- Support for SDIO interrupt mechanism
- Automatic padding data and discarding the padded data on the SDIO bus
- Block size up to 512 bytes
- Interrupt vector between the host and slave for bidirectional interrupt
- Support DMA for data transfer
- Support for wake-up from sleep when connection is retained

33.3 Architecture Overview

The functional block diagram of the SDIO slave module is shown in Figure 33-1.

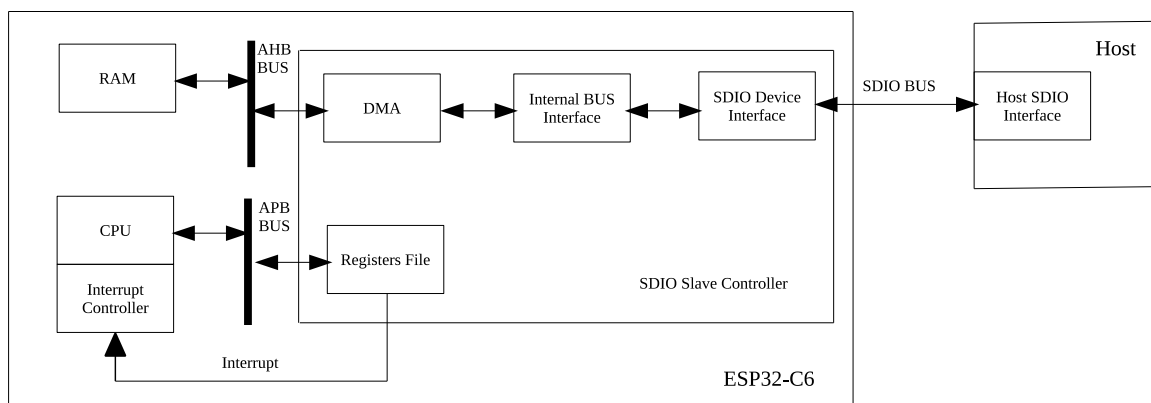

Figure 33-1. SDIO Slave Block Diagram

In the above figure, Host represents any host device that is compatible with SDIO Specification V2.00. It interacts with the ESP32-C6 (configured as the SDIO slave) via the standard SDIO bus implementation.

The SDIO Device Interface block enables effective communication with the external Host by directly providing SDIO interface registers and enabling DMA operation for high-speed data transfer over the Advanced High-Performance Bus (AHB) without engaging the CPU.

33.4 Standards Compliance

The ESP32-C6 SDIO Slave Controller conforms to the following standards:

- SD Specifications Part1 Physical Layer Specification Version 2.00 (referred to as Physical Layer Specification V2.00 in this chapter)
- SD Specifications Part E1 SDIO Specification Version 2.00, January 30, 2007 (referred to as SDIO Specification V2.00 in this chapter)

33.5 Functional Description

33.5.1 Physical Bus

- Bus mode: SPI, 1-bit and 4-bit SDIO transfer modes.
- Bus signal: The physical bus signals of the standard SDIO Specification V2.00, including CS/DI/SCLK/DO/IRQ in the SPI transmission mode, CMD/CLK/DATA/IRQ in the SDIO 1-bit transmission mode, and CMD/CLK/DAT[3:0] in the SDIO 4-bit transmission mode.
- Bus speed mode: full-speed card mode of 0 ~ 50 MHz clock range and low-speed card mode of 0 ~ 400 kHz clock range.
- IO functions: 2 IO functions in addition to function 0. Function 0 is only used for CCCR, FBR, and CIS operations. Function 1 and 2 can be used at the same time to transfer application data packets (such as Wi-Fi packets and Bluetooth packets) and to access SLC Host registers.

For more information, please refer to Physical Layer Specification V2.00 and SDIO Specification V2.00.

33.5.2 Supported Commands

The SDIO 2.0 Slave Controller mainly supports the IO_RW_DIRECT (CMD52) and IO_RW_EXTENDED (CMD53) data transfer commands.

IO_RW_DIRECT (CMD52) can be used to access registers and transfer data, but usually it is used to access registers. Figure 33-2 shows its fields. For the meaning of each field, please refer to the SDIO Specification V2.00.

S	D	Command Index 110100b	R/W flag	Function Number	RAW flag	Stuff	Register Address	RAW flag	Write Data or Stuff Bits	CRC7	E
1	1	6	1	3	1	1	17	1	8	7	1

Figure 33-2. CMD52 Content

IO_RW_EXTENDED (CMD53) is used to initiate the transfer of packets of an arbitrary length. Figure 33-3 shows the its fields. For the meaning of each field, please refer to the SDIO Specification V2.00.

S	D	Command Index 110101b	R/W flag	Function Number	Block Mode 1b	OP Code	Register Address	Byte/Block Count Roundup (Packet_length/Block_size)	CRC7	E
1	1	6	1	3	1	1	17	9	7	1

Figure 33-3. CMD53 Content

33.5.3 I/O Function 0 Address Space

I/O function 0 is only used for Card Common Control Registers (CCCR), Function Basic Registers (FBR), and Card Information Structure (CIS) operations. Figure 33-4 shows its address space map, which is specified by the SDIO Specification. For what each section in this map means, please refer to the Specification.

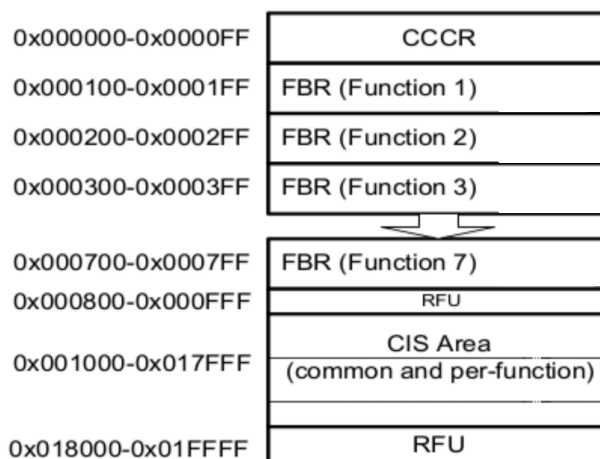

Figure 33-4. Function 0 Address Space

As defined in the SDIO Specification, CCCR are common control registers, FBR are control configuration registers for each function, and CIS are status registers for storing card information, such as version, power consumption, and manufacturer. The functions of these registers are optional, and their meanings are detailed in the SDIO Specification.

The CCCR configuration of ESP32-C6 SDIO slave is shown in Table 33-1, and the FBR configuration is shown Table 33-2.

Table 33-1. SDIO Slave CCCR Configuration

Address	Register Name	Bit 7	Bit 6	Bit 5	Bit 4	Bit 3	Bit 2	Bit 1	Bit 0
0x00	CCCR/SDIO Revision	Set SDIO bit[3:0] using HINF_SDIO_VER[7:4] in HINF_CFG_DATA1_REG				Set CCCR bit[3:0] using HINF_SDIO_VER[3:0] in HINF_CFG_DATA1_REG			
0x01	SD Specification Revision	0 (RFU)				Set SD bit[3:0] using HINF_SDIO_VER[11:8] in HINF_CFG_DATA1_REG			
0x02	I/O Enable	0 (IOE[7:3])				R/W (IOE[2:1])		0 (RFU)	
0x03	I/O Ready	0 (IOR[7:3])				R (IOR[2:1])		0 (RFU)	

Cont'd on next page
PRELIMINARY

Table 33-1. SDIO Slave CCCR Configuration – cont'd from previous page

Address	Register Name	Bit 7	Bit 6	Bit 5	Bit 4	Bit 3	Bit 2	Bit 1	Bit 0	
0x04	Int Enable	0 (IEN[7:3])					R/W (IEN[2:1])		R/W (IENM)	
0x05	Int Pending	0 (INT[7:3])					R (INT[2:1])		0 (RFU)	
0x06	I/O Abort	0 (RFU)				W (RES)	W (AS[2:0])			
0x07	Bus Interface Control	R/W (CD Disable)	1 (SCSI)	R/W (ECSI)	0 (RFU)			R/W (Bus Width[1:0])		
0x08	Card Capability	0 (4BLS)	0 (LSC)	R/W (E4MI)	1 (S4MI)	0 (SBS)	1 (SRW)	1 (SMB)	1 (SDC)	
0x09-0x0B	Common CIS Pointer	Address 0x09: 0x0; Address 0x0A: 0x10; Address 0x0B: 0x0 (Pointer to card's common CIS)								
0x0C	Bus Suspend	0 (RFU)						0 (BR)	0 (BS)	
0x0D	Function Select	0 (DF)	0 (RFU)			0 (FS[3:0])				
0x0E	Exec Flags	0 (EX[7:1])							0 (EXM)	
0x0F	Ready Flags	0 (RF[7:1])							0 (RFM)	
0x10-0x11	FN0 Block Size	R/W (Supported range: 0 - 512) (I/O block size for Function 0)								
0x12	Power Control	0 (RFU)					R/W (EMPC)		1 (SMPC)	
0x13	High-Speed	0 (RFU)					R/W (EHS)		Note ^a (SHS)	

^a Set SHS using HINF_HIGH_SPEED_ENABLE in HINF_CFG_DATA1_REG.

Table 33-2. SDIO Slave FBR Configuration

Address	Bit 7	Bit 6	Bit 5	Bit 4	Bit 3	Bit 2	Bit 1	Bit 0	
0x100	0 (Function 1 CSA enable)	0 (Function 1 supports CSA)	0 (RFU)		0 (Function 1 Standard SDIO Function interface code)				
0x101	0 (Function 1 Extended standard SDIO Function interface code)								
0x102	0 (RFU)					R/W (EPS)		0 (SPS)	

Cont'd on next page

PRELIMINARY

Table 33-2. SDIO Slave FBR Configuration – cont'd from previous page

Address	Bit 7	Bit 6	Bit 5	Bit 4	Bit 3	Bit 2	Bit 1	Bit 0
0x109-0x10B	Address 0x109: 0x0; Address 0x10A: 0x11; Address 0x10B: 0x0 (Pointer to Function 1 CIS)							
0x110-0x111	R/W (Supported range: 0 - 512) (I/O block size for Function 1)							
0x200	0 (Function 2 CSA enable)	0 (Function 2 supports CSA)		0 (RFU)		0x2 (Function 2 Standard SDIO Function interface code)		
0x201	0 (Function 2 Extended standard SDIO Function interface code)							
0x202	0 (RFU)					R/W (EPS)	0 (SPS)	
0x209-0x20B	Address 0x209: 0x0; Address 0x20A: 0x12; Address 0x20B: 0x0 (Pointer to Function 2 CIS)							
0x210-0x211	R/W (Supported range: 0 - 512) (I/O block size for Function 2)							

33.5.4 I/O Function 1/2 Address Space Map

I/O function 1 and 2 have the exactly the same functions and permissions. They can be used at the same time or independently to transmit application data (such as Wi-Fi data and Bluetooth data) in fixed-address packets or incremental-address packets. They can also access the same set of SLC Host registers. Figure 33-5 shows their address space map. All segments in this space can be accessed by the host.

0x0	Fixed address Packet
0x1 -0x3F	Reserved
0x40 -0x3FF	SLC Host Register
0x400 - 0x1F7FF	Incr address Packet

Figure 33-5. Function 1/2 Address Space Map

33.5.4.1 Accessing SLC HOST Register Space

For effective interaction, the host can access the registers that are in contiguous address from 0x40 to 0x3FF in the slave via the I/O function 1/2. To access them, the host simply needs to set the Register Address field of CMD52 or CMD53 to the low 10 bits of their address. Besides, CMD53 allows the host to access multiple registers at one go for a higher transfer rate.

From SLCHOST_CONF_W0_REG and SLCHOST_CONF_W15_REG, there are 52 bytes of fields that the host

and slave can access and change, thus facilitating the information interaction.

The software on both the host and the slave sides can access the SLC Host register space at the same time, so an upper-layer mechanism should be designed to avoid the error caused by such behavior.

33.5.4.2 Transferring Incremental-Address Packets

When the host uses the address 0x400 - 0x1F7FF to continuously transmit multiple application data packets (such as Wi-Fi packets), the address field in CMD53 should be set to increment mode and the OP Code field to 1.

For example, if the host wants to use CMD53 to transfer (send or receive) three data blocks starting from the base address 0x500, then it should:

- Set the Block Mode field in CMD53 to 1, indicating data unit is block
- Set the OP Code field to 1, indicating incremental address mode
- Set the Register Address field to 0x500, indicating the base address is 0x500
- Set the Byte/Block Count field to 0x3, indicating 3 data blocks
- Set other fields according to the SDIO Specification

When the packet is transmitted (slave sends to host, or slave receives from host) through CMD53, the slave will determine whether all the valid data of the current packet has been transmitted so as to pad (when slave sends to host) or discard (when slave receives from host) the invalid data. For more information about data padding and discarding, please refer to Section [33.5.5.3](#).

33.5.4.3 Transferring Fixed-Address Packets

When the host uses address 0x0 to transmit application data packets (such as Bluetooth packets), the address field and OP Code field in CMD53 should be set to 0.

For example, if the host wants to use CMD53 to transfer (send or receive) three data blocks starting from the fixed address 0x0, then it should:

- Set the Block Mode field in CMD53 to 1, indicating data unit is block
- Set the OP Code field to 0, indicating fixed address mode
- Set the Register Address field to 0x0, indicating the fixed address is 0x0
- Set the Byte/Block Count field to 0x3, indicating 3 data blocks
- Set other fields according to the SDIO Specification

When the packet is transmitted (slave sends to host, or slave receives from host) between the host and the slave through CMD53, the slave will determine whether all the valid data of the current packet has been transmitted so as to pad (when slave sends to host) or discard (when slave receives from host) the invalid data. For more information about data padding and discarding, please refer to Section [33.5.5.3](#).

33.5.5 DMA

The SDIO Slave Controller uses a dedicated DMA to access data residing in RAM. As shown in Figure [33-1](#), RAM is accessed over the AHB. For the RAM space accessible by the Controller, please refer to Chapter [5 System and](#)

Memory. To set the RAM address range that can be accessed for one transfer, please configure the *SHAREMEM*_REG fields described in Section 33.8.

DMA has two channels, SLC0 and SLC1. They are used to transfer incremental-address packets and fixed-address packets, respectively. For the convenience of users, the SDIO slave provides function 1/2 for data transmission. The address range of I/O Function 1/2 is detailed in Section 33.5.4. It is recommended to transmit incremental-address packets via SLC0 using function 1 and fixed-address packets via SLC1 using function 2.

DMA accesses RAM over AHB. Users can configure whether the AHB interface can use burst operation and which burst operation type to use by configuring the relevant fields in `SDIO_SLCCONFO_REG` and `SDIO_SLC_BURST_LEN_REG`. For more information, please refer to Section 33.8.

33.5.5.1 Linked List

The slave software can use the DMA engine by mounting linked lists. DMA sends the data from the RAM address space configured in the RX (slave to host) linked list and stores the received data into the address space configured in the TX (host to slave) linked list. A linked list consists of several descriptors.

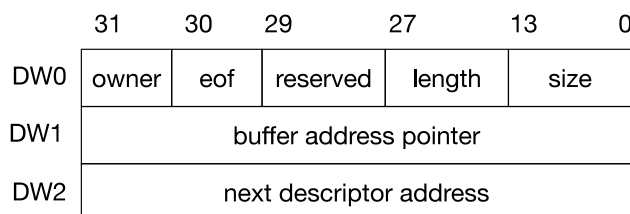

Figure 33-6. DMA Linked List Descriptor Structure of the SDIO Slave

The TX linked list descriptor and the RX linked list descriptor have the same structure, which is shown in Figure 33-6. The descriptor consists of 3 words. The meaning of each field is as follows:

- owner (DW0) [31]: Indicates who is allowed to access the buffer that this descriptor points to.
0: CPU
1: DMA engine
Slave software should set this field to 1 when creating the descriptor. After the DMA write-back permission is enabled and the corresponding buffer is used by the DMA, the field is cleared to 0.
- eof (DW0) [30]: Indicates the end of a data packet.
0: The current descriptor is not the last descriptor of the packet
1: The current descriptor is the last descriptor of the packet
When the host sends a packet to the slave, the slave software should set the field to 0 while creating the descriptor. DMA sets the field of the last descriptor in the packet to 1; When the host receives packets from the slave, the slave software configures the field depending on whether this descriptor is the last descriptor of the packet.
- reserved (DW0) [29:28]: reserved.
Slave software should set this field to 0x0.
- length (DW0) [27:14]: Indicates the number of valid bytes in the corresponding buffer. When the DMA engine is reading data from the buffer, it indicates the number of bytes that can be read; when DMA engine is storing data in the buffer, it indicates the number of bytes of the stored data.

When the host sends a packet to the slave, the slave software should set this field to 0x0 while creating the descriptor. DMA writes back the field after the corresponding buffer is used up; when the host receives the packet from the slave and the slave creates the descriptor, the slave software should set this field to the number of bytes that can be read by the corresponding buffer.

- size (DW0) [13:0]: Indicates the size of the corresponding buffer. Unit: byte. Slave software should configure this field when creating the descriptor.
Note: This field must be word-aligned.
- buffer address pointer (DW1): Buffer address pointer. Slave software should configure this field when creating the descriptor.
Note: This field must be word-aligned.
- next descriptor address (DW2): Address of the next descriptor. When the next descriptor does not exist, the value is 0. Slave software should configure this field when creating the descriptor.

For more information on DMA write-back linked list descriptor fields, please refer to Section 33.5.5.2.

The slave software can combine multiple descriptors into a linked list using the next descriptor address (DW2) field. The SDIO slave DMA linked list is shown in Figure 33-7.

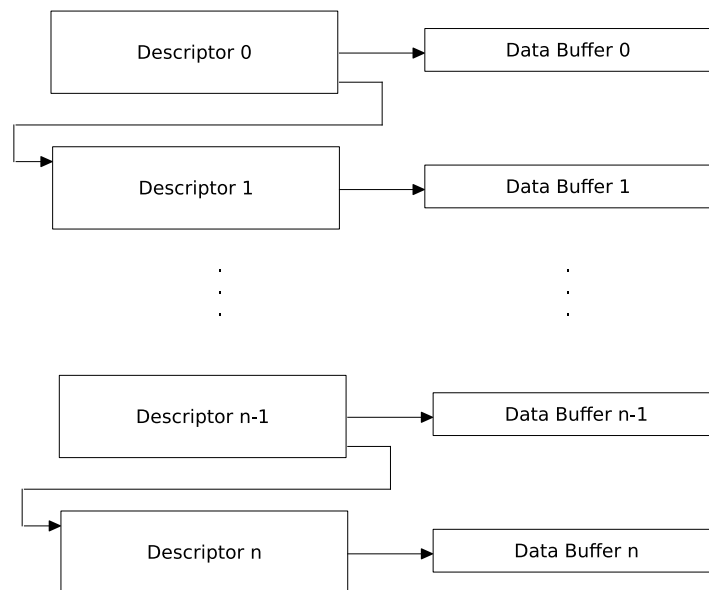

Figure 33-7. DMA Linked List of the SDIO Slave

An example is provided below to facilitate understanding of the linked list and the eof bit. Suppose the slave software creates a linked list that contains 3 descriptors; descriptor 0 points to 500 bytes data and its eof bit is 0; descriptor 1 points to 200 bytes data and its eof bit is 1; descriptor 2 points to 200 bytes data and its eof bit is 1. If the first CMD53 needs to read 400 bytes data, then DMA sends the first 400 bytes data of descriptor 0 to the host. If the second CMD53 needs to read 400 bytes data, firstly DMA sends the remaining 100 bytes data of descriptor 0 to the host. Secondly, it sends 200 bytes data of descriptor 1 to the host. Since the eof bit of descriptor 1 is 1, DMA considers the valid data of the current CMD53 is over. So, lastly DMA sends 100 bytes invalid data 0x0 to the host. If the third CMD53 needs to read 400 bytes data, firstly DMA sends the 200 bytes data of descriptor 2 to the host. Since descriptor 2's eof bit is 1, DMA considers the valid data of current CMD53 is over. So, DMA sends 200 bytes invalid data 0x0 to the host.

33.5.5.2 Write-Back of Linked List

In the process of sending packets from the host to the slave, when the buffer specified by a linked list descriptor is full, or when a packet transmission ends, the DMA engine needs to jump to the next descriptor to store subsequent data. Before the jump, DMA writes back the current descriptor. In DW0, DMA updates the eof and length bits to the latest value. The value of the owner bit is determined by SDIO_SLC0/1_TX_LOOP_TEST in SDIO_SLCCONF0_REG.

In the process of receiving packets from the slave, when the host reads all the data in the buffer specified by a linked list descriptor, DMA engine needs to jump to the next descriptor to read subsequent data. Before the jump, the slave software can set SDIO_SLC0/1_RX_AUTO_WRBACK in SDIO_SLCCONF0_REG to 1 so that the DMA will write back the current descriptor. The value to write to the owner bit is determined by SDIO_SLC0/1_RX_LOOP_TEST in SDIO_SLCCONF0_REG. Values of other bits in DW0 remain unchanged.

The relevant register fields are described in Section 33.8.

33.5.5.3 Data Padding and Discarding

In order to transfer data in blocks, both the host and the slave need to pad the data sent on the SDIO bus into entire blocks. The slave will automatically pad data when sending the packet, and automatically discard the padded data after receiving packets.

- When the host sends a data packet to the slave through CMD53 and the amount of data reaches the length of the data packet, the SDIO slave considers that the valid data of the current data packet is over. At this time, DMA will write back the current linked list descriptor, set the eof bit of the current descriptor to 1, and generate SLC0/1_TX_SUC_EOF_INT interrupt. After it determines that the valid data is over, the remaining data of the current packet will be considered as invalid data, and will not be received into the buffer by DMA. The slave will not restart receiving data into the next buffer until the next CMD53.
 - For incremental-address packets, the slave determines valid data based on the address. The data with the address greater than or equal to 0x1F800 is considered as invalid data and will be discarded. Therefore, the host should set the CMD53 start address field to 0x1F800 – Packet_length (unit: byte). The data flow of incremental-address packets on SDIO bus is shown in Figure 33-8.

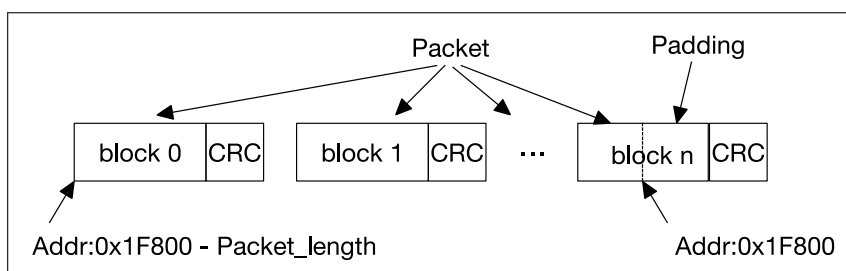

Figure 33-8. Data Flow of Sending Incremental-address Packets From Host to Slave

- For fixed-address packets, the slave considers the first 3 bytes of the data packet as the packet length (including the first 3 bytes, which will also be stored in the buffer specified by the linked list). After the length of the received data reaches the packet length, the subsequent data will be considered as invalid and discarded.

- When the host receives data packets (including incremental-address packets and fixed-address packets) from the slave through CMD53 and DMA reads the last byte of a buffer and the eof bit of the DMA linked list descriptor is 1, the SDIO slave will consider the valid data of the current packet is over. At this time, DMA will write back the current descriptor and generate `SLC0/1_RX_EOF_INT` interrupt. After it is determined that the valid data is over, the remaining bits of the current data packet will be padded with invalid data 0x0, and will not be read from the buffer via DMA. The slave will restart to read data from the buffer via DMA until the next CMD53.

Note: When the host receives either incremental-address or fixed-address data packets from the slave, the eof bit of the DMA linked list descriptor is always considered as the basis for determining the end of data, rather than the address 0x1F800. Therefore, when the host sends multiple CMD53s to obtain multiple data packets, as long as the DMA does not encounter the eof bit is 1 in the descriptors, the slave will obtain the data from buffers in sequence according to the linked list and then transmit them to the host; when the DMA encounters the eof bit is 1, the data will be fetched from the corresponding buffer, and then invalid data will be added to complete the current CMD53 command, and the next CMD53 command will take data from the buffer pointed to by the next descriptor.

33.5.6 SDIO Bus Timing

The SDIO bus operates at a very high speed and the PCB trace length usually affects signal integrity by introducing latency. To ensure that the timing characteristics conform to the desired bus timing, the SDIO slave module supports configuration of input sampling clock edge and output driving clock edge.

When the incoming data changes near the rising edge of the clock, the slave will perform sampling on the falling edge of the clock, or vice versa, as Figure 33-9 shows.

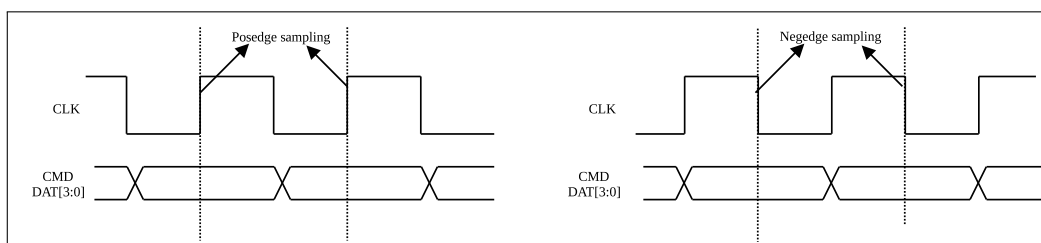

Figure 33-9. Sampling Timing Diagram

By default, the MTMS (GPIO4) strapping value determines the slave's sampling edge. However, users can decide the sampling edge by configuring the `SLCHOST_CONF_REG` register, with priority from high to low: (1) Set `SLCHOST_FRC_POS_SAMP` to sample the corresponding signal at the rising edge; (2) Set `SLCHOST_FRC_NEG_SAMP` to sample the corresponding signal at the falling edge.

`SLCHOST_FRC_POS_SAMP` and `SLCHOST_FRC_NEG_SAMP` fields are five bits wide. The bits correspond to the CMD line and four DATA lines (0-3). Setting a bit causes the corresponding line to be sampled for input at the rising clock edge or falling clock edge.

The slave can also select which edge to drive the output lines, in order to accommodate for any latency caused by the physical signal path. The output timing is shown in Figure 33-10.

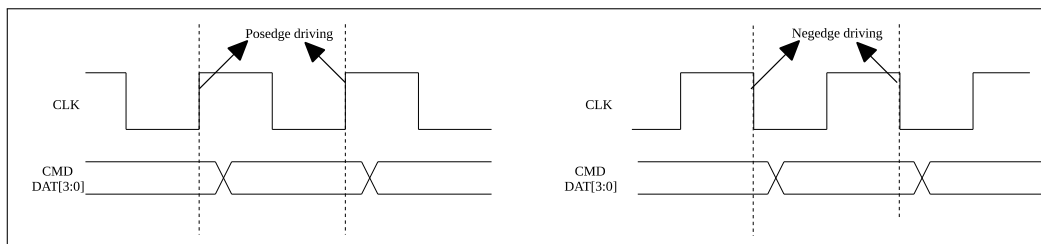

Figure 33-10. Output Timing Diagram

By default, the MTDI (GPIO5) strapping value determines the slave's output driving edge. However, users can decide the output driving edge by configuring the following registers, with priority from high to low: (1) Set SLCHOST_FRC_SDIO11 in [SLCHOST_CONF_REG](#) to output the corresponding signal at the falling clock edge; (2) Set SLCHOST_FRC_SDIO22 in [SLCHOST_CONF_REG](#) to output the corresponding signal at the rising clock edge; (3) Set HINF_HIGHSPEED_ENABLE in [HINF_CFG_DATA1_REG](#) and SLCHOST_HSPEED_CON_EN in [SLCHOST_CONF_REG](#), then set the EHS (Enable High-Speed) bit in CCCR at the host side to output the corresponding signal at the rising clock edge.

SLCHOST_FRC_SDIO11 and SLCHOST_FRC_SDIO22 fields are five bits wide. The bits correspond to the CMD line and four DATA lines (0-3). Setting a bit causes the corresponding line to output at the rising clock edge or falling clock edge.

Notes on priority setting: The configuration of strapping pins has the lowest priority when controlling the sampling edge or driving edge. The lower-priority configuration takes effect only when the higher-priority configuration is not set. For example, the MTMS (GPIO4) strapping value determines the sampling edge only when SCLHOST_FRC_POS_SAMP and SCLHOST_FRC_NEG_SAMP are not set.

33.6 Interrupt

The host and the slave can interrupt each other via the interrupt vector. There are 8 interrupt vectors between the host and each DMA SLC channel of the slave. To send an interrupt to the other side, the enable bit of the interrupt vector register should be set to 1.

33.6.1 Host Interrupt

- *SLCHOST_SLC0/1_RX_NEW_PACKET_INT* : The slave has a packet to send. Any of the cases below can trigger the interrupt.
 - When [SDIO_SLC0_RXLINK_START](#) or [SDIO_SLC1_RXLINK_START](#) is set to enable DMA
 - When a new RX linked list descriptor is coming after DMA processes the RX linked list descriptor with the eof bit being 1
 - When a packet needs to be retry
- *SLCHOST_SLC0/1_TX_OVF_INT* : Slave receiving buffer overflow interrupt
- *SLCHOST_SLC0/1_RX_UDF_INT* : Slave sending buffer underflow interrupt.
- *SLCHOST_SLC0/1_TOHOST_BITn_INT* (*n*: 0 ~ 7): Slave interrupts the host.

33.6.2 Slave Interrupt

- *SLC0/1_RX_DSCR_ERR_INT* : Slave sending linked list descriptor error.
- *SLC0/1_TX_DSCR_ERR_INT* : Slave receiving linked list descriptor error.
- *SLC0/1_RX_EOF_INT* : Slave sending operation is finished.
- *SLC0/1_RX_DONE_INT* : A single buffer is sent by the slave.
- *SLC0/1_TX_SUC_EOF_INT* : Slave receiving operation is finished.
- *SLC0/1_TX_DONE_INT* : A single buffer is finished during receiving operation.
- *SLC0/1_TX_OVF_INT* : Slave receiving buffer overflow interrupt.
- *SLC0/1_RX_UDF_INT* : Slave sending buffer underflow interrupt.
- *SLC0/1_TX_START_INT* : Slave receiving start interrupt.
- *SLC0/1_RX_START_INT* : Slave sending start interrupt.
- *SLC_FRHOST_BIT n _INT* (n : 0 ~ 15): The host interrupts the slave via the SLC0 channel if interrupt vector Bit[7:0] is set or via the SLC1 channel if interrupt vector Bit[15:8] is set.

33.7 Packet Sending and Receiving Procedure

The SDIO host and slave devices need to follow specific data transfer procedures to successfully exchange data over the SDIO interface. Beside SDIO Specifications, ESP32-C6 should also follow the procedures below to transmit data over higher abstraction layers, such as Wi-Fi and Bluetooth data.

33.7.1 Sending Packets to SDIO Host

The transmission of packets from the slave to the host is initiated by the slave. The host will be notified with an interrupt (for detailed information on interrupts, please refer to SDIO Specification). After the host reads the relevant information from the slave, it will initiate an SDIO bus transmission accordingly. The whole procedure is illustrated in Figure 33-11.

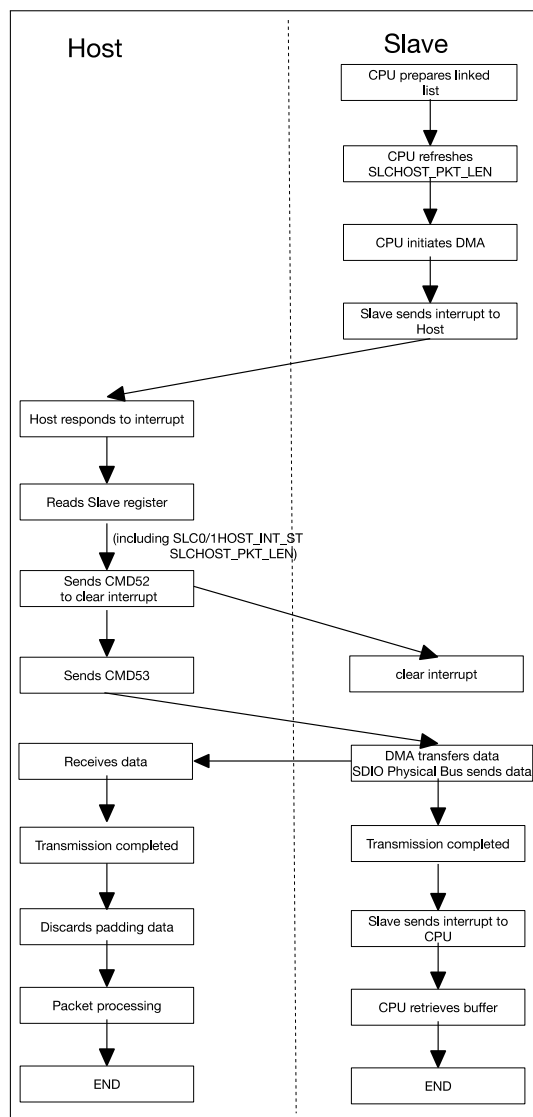

Figure 33-11. Procedure of Slave Sending Packets to Host

1. The slave CPU creates the linked list for the data packets that it will send to the host. For how to create a linked list, please refer to Section 33.5.5.1.
2. The slave CPU updates the length of data that will be sent to the host using the register [SDIO_SLC0_LEN_CONF_REG](#).
3. The slave CPU starts DMA by writing the 32-bit address of the first descriptor in linked list to [SDIO_SLC0RX_LINK_ADDR_REG](#) or [SDIO_SLC1RX_LINK_ADDR_REG](#) and then configuring [SDIO_SLC0_RXLINK_START](#) or [SDIO_SLC1_RXLINK_START](#) to start DMA. For more information on DMA, please refer to Section 33.5.5.
4. The slave DMA sends an interrupt to the host.
5. After the host received the interrupt, it reads from [SLCHOST_SLC0HOST_INT_ST_REG](#), [SLCHOST_SLC1HOST_INT_ST_REG](#), and [SLCHOST_PKT_LEN_REG](#) the following information:
 - [SLCHOST_SLC0/1HOST_INT_ST_REG](#): Interrupt status register. If the [SLCHOST_SLC0/1_RX_NEW_PACKET_INT_ST](#) bit is 1, this indicates that the slave has packets to send.

- SLCHOST_PKT_LEN_REG: Packet length accumulator register. The current value minus the value of last time equals the packet length sent this time.
6. The host clears the interrupt through CMD52.
 7. The host fetches packets from the slave through CMD53. During the transmission, when the slave determines that the valid data of the current packet is over, the subsequent bits will be padded with invalid data 0x0. For how to determine the end of valid data, please refer to Section [33.5.5.3](#).
 8. After the packets is transmitted, the slave DMA sends an interrupt to the CPU, and the CPU can recycle the buffer at this time.

Notes:

- It is not recommended to set all of the eof bits to 0 in the linked list. Otherwise, the DMA may send the data of the next packet to the current command, which may cause errors. In cases where all of the eof bits is set to 0, the slave software should align the length of each packet to the size of the data block by padding data, to prevent the DMA from sending the data of the next packet to the current command. When the host sends CMD53 to read data, it should accurately control the number of data blocks in each packet, do not read more or less data blocks. Besides, the host should be able to identify the padded data.
- It is recommended that a CMD53 command only should transmit one data packet and each data packet should use only one linked list so as to avoid unknown exceptions caused by complex transmission.
- It is not recommended to send multiple packets through one linked list because it may be difficult for the host and software to split between the data packets. In cases where this has to be done, the software should set the eof bit when creating the linked list to divide the data packets so that the DMA can pad data packets accordingly (it is recommended that the length of each data packet should be aligned to the size of the data block to avoid data padding by DMA), and the host should be able to identify the padded data.

33.7.2 Receiving Packets from SDIO Host

Transmission of packets from the host to slave is initiated by the host. The slave receives data via DMA and stores it in RAM. After transmission is completed, the CPU will be interrupted to process the data. The whole procedure is demonstrated in Figure [33-12](#).

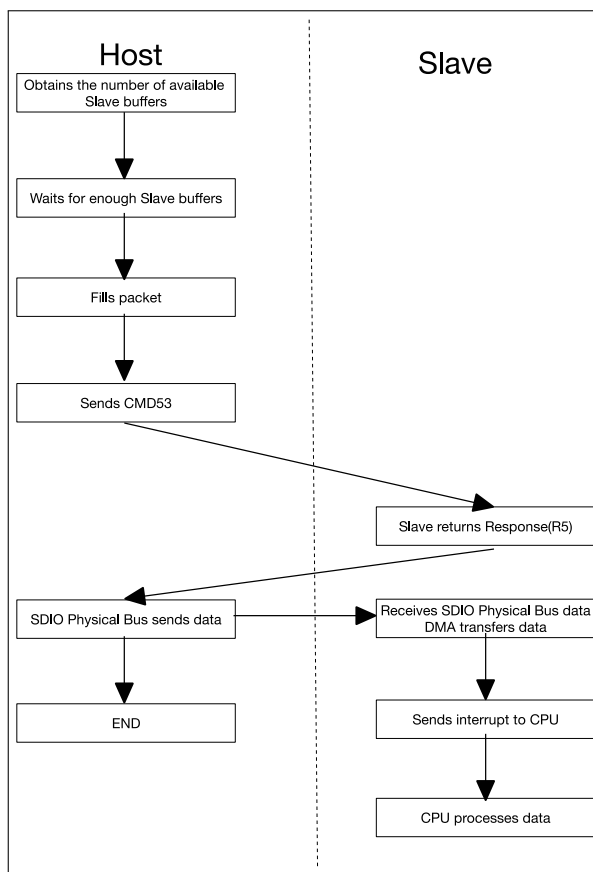

Figure 33-12. Procedure of Slave Receiving Packets from Host

The host obtains the number of available receiving buffers from the slave by accessing [SLCHOST_SLC0HOST_TOKEN_RDATA_REG](#) or [SLCHOST_SLC1HOST_TOKEN_RDATA_REG](#). The slave CPU should update the value of the register after the receiving DMA linked list is prepared.

[SLCHOST_HOSTSLCHOST_SLC0_TOKEN1](#) or [SLCHOST_HOSTSLCHOST_SLC1_TOKEN1](#) stores the accumulated number of available buffers. The host can figure out the available buffer space, using the register value minus the number of buffers already used. If the buffers are not enough, the host needs to constantly poll the register until there are enough buffers available.

During the transmission of packets to the slave through the CMD53 command, when a buffer specified by a linked list descriptor is written full, or when a packet transmission ends, the DMA will jump to the next buffer to store subsequent data. When the slave determines that the valid data of the current packet is over, the remaining data will be considered invalid and discarded, DMA will write back the current linked list descriptor, set the eof bit of the current descriptor to 1, and the [SLC0/1_TX_SUC_EOF_INT](#) interrupt will be generated.

For more information about DMA functions, linked list, and data discarding, please refer to Section [33.5.5](#).

To ensure sufficient receiving buffers, the slave CPU must constantly load buffers on the receiving linked list. The process is shown in Figure [33-13](#).

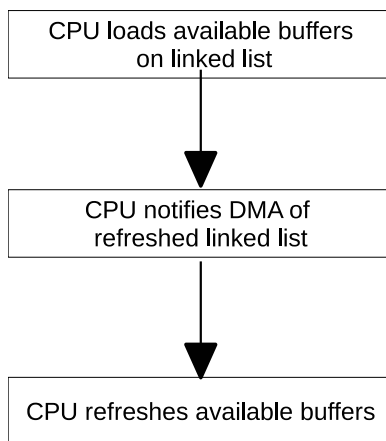

Figure 33-13. Loading Receiving Buffer

The CPU first needs to append new buffer segments at the end of the linked list that is being used by DMA and is available for receiving data.

The CPU then needs to notify the DMA that the linked list has been updated. This can be done by setting [SDIO_SLC0_TXLINK_RESTART](#) or [SDIO_SLC1_TXLINK_RESTART](#). Please note that when the CPU initiates DMA to receive packets for the first time, [SDIO_SLC0_TXLINK_START](#) or [SDIO_SLC1_TXLINK_START](#) should be set to 1.

Notes: Use the *_RESTART field to restart DMA only in the two scenarios:

- DMA is suspended by configuration of the *_STOP field.
- DMA is suspended as a result of insufficient linked list descriptors. Users can restart it after descriptors are added.

Lastly, the CPU refreshes any available buffer information by writing to the [SDIO_SLC0TOKEN1_REG](#) or [SDIO_SLC1TOKEN1_REG](#) register.

33.8 Register Summary

The addresses in this section are relative to **SDIO 2.0 Slave Controller** base address provided in Table 5-2 in Chapter 5 *System and Memory*.

The abbreviations given in Column **Access** are explained in Section *Access Types for Registers*.

33.8.1 HINF Register Summary

Name	Description	Address	Access
Configuration registers			
HINF_CFG_DATA0_REG	SDIO CIS configuration	0x0000	R/W
HINF_CFG_DATA1_REG	SDIO configuration	0x0004	R/W
HINF_CFG_DATA7_REG	SDIO configuration	0x001C	varies
HINF_CIS_CONF_W n _REG(n : 0-7)	SDIO CIS configuration	0x0020+0x4* n	R/W
HINF_CFG_DATA16_REG	SDIO CIS configuration	0x0040	R/W
Status registers			
HINF_CONF_STATUS_REG	SDIO CIS function 0 config0 status	0x0054	RO

33.8.2 SLC Register Summary

Name	Description	Address	Access
Configuration registers			
SDIO_SLCCONF0_REG	DMA configuration	0x0000	R/W
SDIO_SLC0RX_LINK_REG	SCL0 RX linked list configuration	0x003C	varies
SDIO_SLC0RX_LINK_ADDR_REG	SCL0 RX linked list address	0x0040	R/W
SDIO_SLC0TX_LINK_REG	SCL0 TX linked list configuration	0x0044	varies
SDIO_SLC0TX_LINK_ADDR_REG	SCL0 TX linked list address	0x0048	R/W
SDIO_SLC1RX_LINK_REG	SCL1 RX linked list configuration	0x004C	varies
SDIO_SLC1RX_LINK_ADDR_REG	SCL1 RX linked list address	0x0050	R/W
SDIO_SLC1TX_LINK_REG	SCL1 TX linked list configuration	0x0054	varies
SDIO_SLC1TX_LINK_ADDR_REG	SCL1 TX linked list address	0x0058	R/W
SDIO_SLC0TOKEN1_REG	SLC0 receiving buffer configuration	0x0064	varies
SDIO_SLC1TOKEN1_REG	SLC1 receiving buffer configuration	0x006C	varies
SDIO_SLCCONF1_REG	DMA configuration	0x0070	R/W
SDIO_SLC_RX_DSCR_CONF_REG	DMA slave to host configuration register	0x00A8	R/W
SDIO_SLC0_LEN_CONF_REG	Length control of transmitting packets	0x00F4	varies
SDIO_SLC0_TX_SHAREMEM_START_REG	SLC0 AHB TX start address range	0x0154	R/W
SDIO_SLC0_TX_SHAREMEM_END_REG	SLC0 AHB TX end address range	0x0158	R/W
SDIO_SLC0_RX_SHAREMEM_START_REG	SLC0 AHB RX start address range	0x015C	R/W
SDIO_SLC0_RX_SHAREMEM_END_REG	SLC0 AHB RX end address range	0x0160	R/W
SDIO_SLC1_TX_SHAREMEM_START_REG	SLC1 AHB TX start address range	0x0164	R/W
SDIO_SLC1_TX_SHAREMEM_END_REG	SLC1 AHB TX end address range	0x0168	R/W
SDIO_SLC1_RX_SHAREMEM_START_REG	SLC1 AHB RX start address range	0x016C	R/W
SDIO_SLC1_RX_SHAREMEM_END_REG	SLC1 AHB RX end address range	0x0170	R/W

Name	Description	Address	Access
SDIO_SLC_BURST_LEN_REG	DMA AHB burst type configuration	0x017C	R/W
Interrupt registers			
SDIO_SLC0INT_RAW_REG	SLC0 to slave raw interrupt status	0x0004	varies
SDIO_SLC0INT_ST_REG	SLC0 to slave masked interrupt status	0x0008	RO
SDIO_SLC0INT_ENA_REG	SLC0 to slave interrupt enable	0x000C	R/W
SDIO_SLC0INT_CLR_REG	SLC0 to slave interrupt clear	0x0010	WT
SDIO_SLC1INT_RAW_REG	SLC1 to slave raw interrupt status	0x0014	varies
SDIO_SLC1INT_CLR_REG	SLC1 to slave interrupt clear	0x0020	WT
SDIO_SLCINTVEC_TOHOST_REG	Slave to host interrupt vector set	0x005C	WT
SDIO_SLC1INT_ST1_REG	SLC1 to slave masked interrupt status	0x014C	RO
SDIO_SLC1INT_ENA1_REG	SLC1 to slave interrupt enable	0x0150	R/W
Status registers			
SDIO_SLC0_LENGTH_REG	Length of transmitting packets	0x00F8	RO

33.8.3 SLC Host Register Summary

Name	Description	Address	Access
Configuration registers			
SLCHOST_CONF_REG	Edge configuration	0x01F0	R/W
Interrupt registers			
SLCHOST_SLC0HOST_INT_RAW_REG	SLC0 to host raw interrupt status	0x0050	varies
SLCHOST_SLC1HOST_INT_RAW_REG	SLC1 to host raw interrupt status	0x0054	varies
SLCHOST_SLC0HOST_INT_ST_REG	SLC0 to host masked interrupt status	0x0058	RO
SLCHOST_SLC1HOST_INT_ST_REG	SLC1 to host masked interrupt status	0x005C	RO
SLCHOST_CONF_W7_REG	Host to slave interrupt vector set	0x008C	R/W
SLCHOST_SLC0HOST_INT_CLR_REG	SLC0 to host interrupt clear	0x00D4	WT
SLCHOST_SLC1HOST_INT_CLR_REG	SLC1 to host interrupt clear	0x00D8	WT
SLCHOST_SLC0HOST_FUNC1_INT_ENA_REG	SLC0 to host interrupt enable	0x00DC	R/W
SLCHOST_SLC1HOST_FUNC1_INT_ENA_REG	SLC0 to host interrupt enable	0x00E0	R/W
Status registers			
SLCHOST_SLC0HOST_TOKEN_RDATA_REG	Accumulated number of SLC0 receiving buffers	0x0044	RO
SLCHOST_PKT_LEN_REG	Length of the transmitting packets	0x0060	RO
SLCHOST_SLC1HOST_TOKEN_RDATA_REG	Accumulated number of SLC1 receiving buffers	0x00C4	RO
Communication Registers			
SLCHOST_CONF_W n _REG(n : 0-2)	Host and slave communication	0x006C+0x4* n	R/W
SLCHOST_CONF_W3_REG	Host and slave communication	0x0078	R/W
SLCHOST_CONF_W4_REG	Host and slave communication	0x007C	R/W
SLCHOST_CONF_W6_REG	Host and slave communication	0x0088	R/W
SLCHOST_CONF_W n _REG(n : 8-15)	Host and slave communication	0x009C+0x4*(n -8)	R/W

33.9 Registers

The addresses in this section are relative to **SDIO 2.0 Slave Controller** base address provided in Table 5-2 in Chapter 5 *System and Memory*.

33.9.1 HINF Registers

Register 33.1. HINF_CFG_DATA0_REG (0x0000)

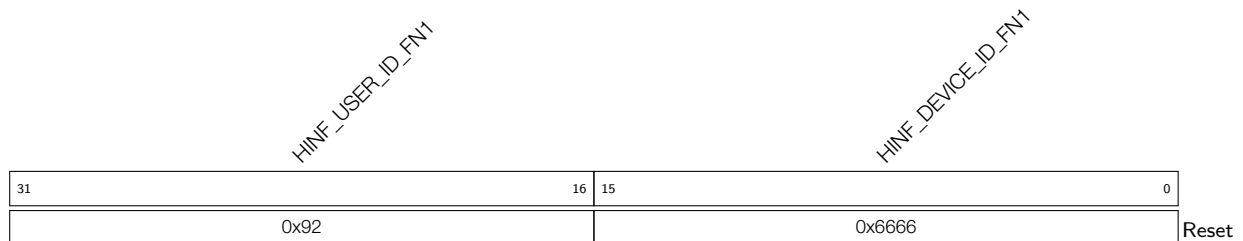

HINF_DEVICE_ID_FN1 Configures device ID of function 1 in SDIO CIS. (R/W)

HINF_USER_ID_FN1 Configures user ID of function 1 in SDIO CIS. (R/W)

Register 33.2. HINF_CFG_DATA1_REG (0x0004)

31	25	24	23	12	11	10	9	8	7	6	5	4	3	2	1	0	Reset
0	0	0x232			0	0	0	0	0	0	0	1	0	0	0	1	

HINF_SDIO_IOREADY1 Configures the field IOR1 in SDIO CCCR and the field function 1 ready in SDIO CIS.

0: The function 1 is not ready

1: The function 1 is ready

Please refer to SDIO Specification for details.

(R/W)

HINF_HIGHSPEED_ENABLE Configures whether to support SHS in SDIO CCCR.

0: Not support High-Speed mode

1: Support High-Speed mode

Please refer to SDIO Specification for details.

(R/W)

HINF_HIGHSPEED_MODE Represents whether EHS status is enabled in SDIO CCCR.

0: Disabled

1: Enabled

Please refer to SDIO Specification for details.

(RO)

HINF_SDIO_CD_ENABLE Configures whether to enable SDIO card detection.

0: Disable

1: Enable

(R/W)

HINF_SDIO_IOREADY2 Configures the field IOR2 in SDIO CCCR and the field function 2 ready in SDIO CIS.

0: The function 2 is not ready

1: The function 2 is ready

Please refer to SDIO Specification for details.

(R/W)

HINF_IOENABLE2 Represents whether IOE2 is enabled in SDIO CCCR.

0: The function 2 is disabled

1: The function 2 is enabled

Please refer to SDIO Specification for details.

(RO)

Continued on the next page...

Register 33.2. HINF_CFG_DATA1_REG (0x0004)

Continued from the previous page...

HINF_CD_DISABLE Represents whether CD is disabled in SDIO CCCR.

0: Enabled

1: Disabled

Please refer to SDIO Specification for details.

(RO)

HINF_FUNC1_EPS Represents function 1 EPS status in SDIO FBR.

0: The function 1 operates in Higher Current Mode

1: The function 1 works in Lower Current Mode

Please refer to SDIO Specification for details.

(RO)

HINF_EMP Represents EMPC status in SDIO CCCR.

0: Master Power Control is disabled

1: Master Power Control is enabled

Please refer to SDIO Specification for details.

(RO)

HINF_IOENABLE1 Represents IOE1 status in SDIO CCCR.

0: The function 1 is disabled

1: The function 1 is enabled

Please refer to SDIO Specification for details.

(RO)

HINF_SDIO_VER Configures SD bit[3:0], SDIO bit[3:0], CCCR bit[3:0] in SDIO CCCR.

HINF_SDIO_VER[11:8] mapping to SD bit[3:0]

HINF_SDIO_VER[7:4] mapping to SDIO bit[3:0]

HINF_SDIO_VER[3:0] mapping to CCCR bit[3:0]

Please refer to SDIO Specification for details.

(R/W)

HINF_FUNC2_EPS Represents function 2 EPS status in SDIO FBR.

0: The function 2 operates in Higher Current Mode

1: The function 2 works in Lower Current Mode

Please refer to SDIO Specification for details.

(RO)

Register 33.3. HINF_CFG_DATA7_REG (0x001C)

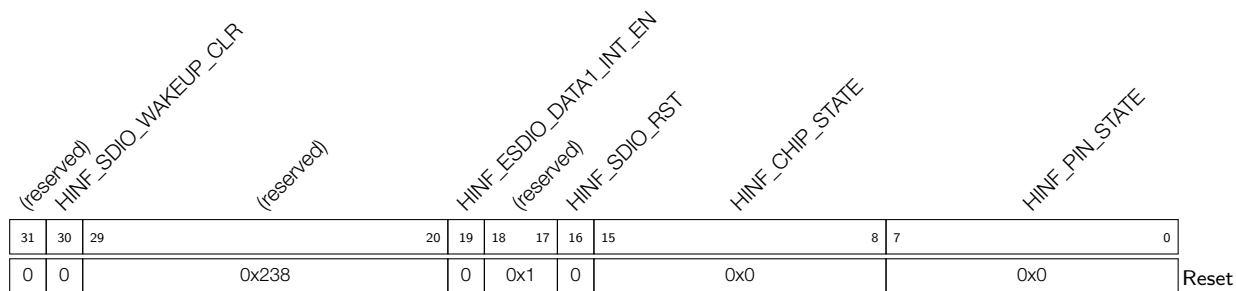

HINF_PIN_STATE Configures SDIO CIS address 318 and 574. Please refer to SDIO Specification for details. (R/W)

HINF_CHIP_STATE Configures SDIO CIS address 312, 315, 568, and 571. Please refer to SDIO Specification for details. (R/W)

HINF_SDIO_RST Configures whether to reset the SDIO slave module.
 0: No effect
 1: Reset
 (R/W)

HINF_ESDIO_DATA1_INT_EN Configures whether to enable SDIO interrupt on data1 line.
 0: Disable
 1: Enable
 (R/W)

HINF_SDIO_WAKEUP_CLR Configures whether to clear wake up signal after the chip is waken up by the SDIO slave.
 0: No effect
 1: Clear
 (WT)

Register 33.4. HINF_CIS_CONF_Wn_REG(n: 0-7) (0x0020+0x4*n)

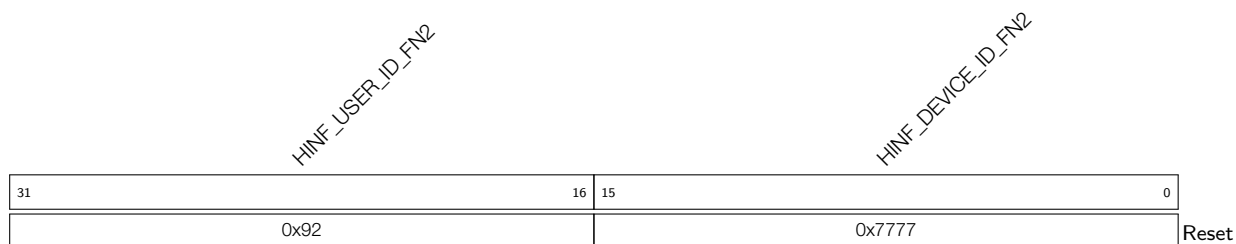

HINF_CIS_CONF_Wn Configures SDIO CIS address (39+4*n) ~ (36+4*n). Please refer to SDIO Specification for details. (R/W)

Register 33.5. HINF_CFG_DATA16_REG (0x0040)

HINF_DEVICE_ID_FN2 Configures device ID of function 2 in SDIO CIS. (R/W)

HINF_USER_ID_FN2 Configures user ID of function 2 in SDIO CIS. (R/W)

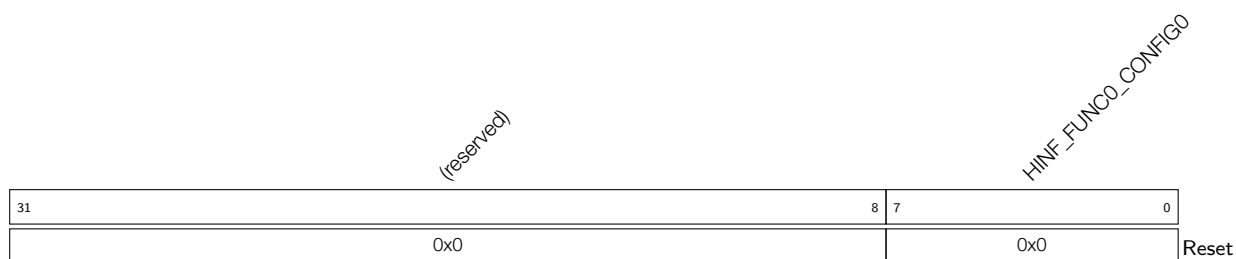
Register 33.6. HINF_CONF_STATUS_REG (0x0054)

HINF_FUNC0_CONFIG0 Represents SDIO CIS function 0 config0 (addr: 0x20f0) status. Please refer to SDIO Specification for details. (RO)

33.9.2 SLC Registers

Register 33.7. SDIO_SLCCONF0_REG (0x0000)

(reserved)	SDIO_SLC1_TOKEN_AUTO_CLR	SDIO_SLC1_TXDATA_BURST_EN	SDIO_SLC1_TXDSCR_BURST_EN	(reserved)	SDIO_SLC1_RXDATA_BURST_EN	SDIO_SLC1_RXDSCR_BURST_EN	SDIO_SLC1_RX_NO_RESTART_CLR	SDIO_SLC1_RX_AUTO_WRBK	SDIO_SLC1_RX_LOOP_TEST	(reserved)	SDIO_SLC1_TX_LOOP_TEST	(reserved)	SDIO_SLC0_TOKEN_AUTO_CLR	SDIO_SLC0_TXDATA_BURST_EN	SDIO_SLC0_TXDSCR_BURST_EN	(reserved)	SDIO_SLC0_RXDATA_BURST_EN	SDIO_SLC0_RXDSCR_BURST_EN	SDIO_SLC0_RX_NO_RESTART_CLR	SDIO_SLC0_RX_AUTO_WRBK	SDIO_SLC0_RX_LOOP_TEST	(reserved)	SDIO_SLC0_TX_LOOP_TEST	SDIO_SLC0_RX_RST	SDIO_SLC0_TX_RST						
31	30	29	28	27	26	25	24	23	22	21	20	19	18	17	16	15	14	13	12	11	10	9	8	7	6	5	4	3	2	1	0
1	1	1	1	0x3	1	1	0	0	1	1	0x3	0	0	1	1	1	1	1	0x3	1	1	0	0	0	0	0x0	0	0	Reset		

SDIO_SLC0_TX_RST Configures whether to reset TX (host to slave) FSM (finite state machine) in SLC0.
 0: No effect
 1: Reset
 (R/W)

SDIO_SLC0_RX_RST Configures whether to reset RX (slave to host) FSM in SCL0.
 0: No effect
 1: Reset
 (R/W)

SDIO_SLC0_TX_LOOP_TEST Configures whether SCL0 loops around when the slave buffer finishes receiving packets from the host.
 0: Not loop around
 1: Loop around, and hardware will not change the owner bit in the linked list
 (R/W)

SDIO_SLC0_RX_LOOP_TEST Configures whether SCL0 loops around when the slave buffer finishes sending packets to the host.
 0: Not loop around
 1: Loop around, and hardware will not change the owner bit in the linked list
 (R/W)

SDIO_SLC0_RX_AUTO_WRBK Configures whether SCL0 changes the owner bit of RX linked list.
 0: Not change
 1: Change
 (R/W)

SDIO_SLC0_RX_NO_RESTART_CLR Please initialize to 1, and do not modify it. (R/W)

SDIO_SLC0_RXDSCR_BURST_EN Configures whether SCL0 can use AHB burst operation when reading the RX linked list from memory.
 0: Only use single operation
 1: Can use burst operation
 (R/W)

Continued on the next page...

Register 33.7. SDIO_SLCCONF0_REG (0x0000)

Continued from the previous page...

SDIO_SLC0_RXDATA_BURST_EN Configures whether SCL0 can use AHB burst operation when read data from memory.

0: Only use single operation

1: Can use burst operation

(R/W)

SDIO_SLC0_TXDSCR_BURST_EN Configures whether SCL0 can use AHB burst operation when read the TX linked list from memory.

0: Only use single operation

1: Can use burst operation

(R/W)

SDIO_SLC0_TXDATA_BURST_EN Configures whether SCL0 can use AHB burst operation when send data to memory.

0: Only use single operation

1: Can use burst operation

(R/W)

SDIO_SLC0_TOKEN_AUTO_CLR Please initialize to 0, and do not modify it. (R/W)

SDIO_SLC1_TX_RST Configures whether to reset TX FSM in SLC1.

0: No effect

1: Reset

(R/W)

SDIO_SLC1_RX_RST Configures whether to reset RX FSM in SLC1.

0: No effect

1: Reset

(R/W)

SDIO_SLC1_TX_LOOP_TEST Configures whether SCL1 loops around when the slave buffer finishes receiving packets from the host.

0: Not loop around

1: Loop around, and hardware will not change the owner bit in the linked list

(R/W)

SDIO_SLC1_RX_LOOP_TEST Configures whether SCL1 loops around when the slave buffer finishes sending packets to the host.

0: Not loop around

1: Loop around, and hardware will not change the owner bit in the linked list

(R/W)

Continued on the next page...

Register 33.7. SDIO_SLCCONF0_REG (0x0000)

Continued from the previous page...

SDIO_SLC1_RX_AUTO_WRBACK Configures whether SCL1 changes the owner bit of the RX linked list.

0: Not change

1: Change

(R/W)

SDIO_SLC1_RX_NO_RESTART_CLR Please initialize to 1, and do not modify it. (R/W)

SDIO_SLC1_RXDSCR_BURST_EN Configures whether SCL1 can use AHB burst operation when read the RX linked list from memory.

0: Only use single operation

1: Can use burst operation

(R/W)

SDIO_SLC1_RXDATA_BURST_EN Configures whether SCL1 can use AHB burst operation when reading data from memory.

0: Only use single operation

1: Can use burst operation

(R/W)

SDIO_SLC1_TXDSCR_BURST_EN Configures whether SCL1 can use AHB burst operation when read the TX linked list from memory.

0: Only use single operation

1: Can use burst operation

(R/W)

SDIO_SLC1_TXDATA_BURST_EN Configures whether SCL1 can use AHB burst operation when send data to memory.

0: Only use single operation

1: Can use burst operation

(R/W)

SDIO_SLC1_TOKEN_AUTO_CLR Please initialize to 0, and do not modify it. (R/W)

Register 33.8. SDIO_SLC0RX_LINK_REG (0x003C)

(reserved)					
31	30	29	28	27	0
1	0	0	0	0x0	
					Reset

SDIO_SLC0_RXLINK_STOP Configures whether to stop SLC0 RX linked list operation.

0: No effect

1: Stop the operation

(R/W/SC)

SDIO_SLC0_RXLINK_START Configures whether to start SLC0 RX linked list operation from the address indicated by SDIO_SLC0_RXLINK_ADDR.

0: No effect

1: Start the operation

(R/W/SC)

SDIO_SLC0_RXLINK_RESTART Configures whether to restart and continue SLC0 RX linked list operation.

0: No effect

1: Restart the operation

(R/W/SC)

SDIO_SLC0_RXLINK_PARK Represents SLC0 RX linked list FSM state.

0: The FSM not in idle state

1: The FSM in idle state

(RO)

Register 33.9. SDIO_SLC0RX_LINK_ADDR_REG (0x0040)

(reserved)		
31	0	
0x0		
		Reset

SDIO_SLC0_RXLINK_ADDR Configures SLC0 RX linked list initial address. (R/W)

Register 33.10. SDIO_SLC0TX_LINK_REG (0x0044)

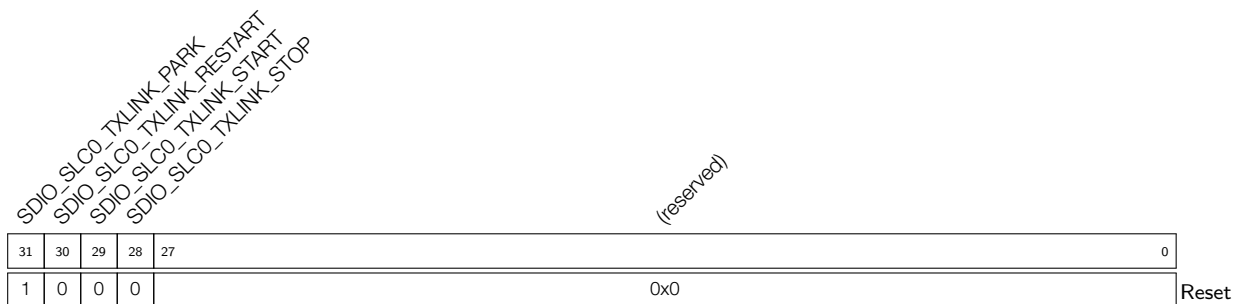

SDIO_SLC0_TXLINK_STOP Configures whether to stop SLC0 TX linked list operation.

- 0: No effect
 - 1: Stop the operation
- (R/W/SC)

SDIO_SLC0_TXLINK_START Configures whether to start SLC0 TX linked list operation from the address indicated by SDIO_SLC0_TXLINK_ADDR.

- 0: No effect
 - 1: Start the operation
- (R/W/SC)

SDIO_SLC0_TXLINK_RESTART Configures whether to restart and continue SLC0 TX linked list operation.

- 0: No effect
 - 1: Restart the operation
- (R/W/SC)

SDIO_SLC0_TXLINK_PARK Represents SLC0 TX linked list FSM state.

- 0: The FSM not in idle state
 - 1: The FSM in idle state
- (RO)

Register 33.11. SDIO_SLC0TX_LINK_ADDR_REG (0x0048)

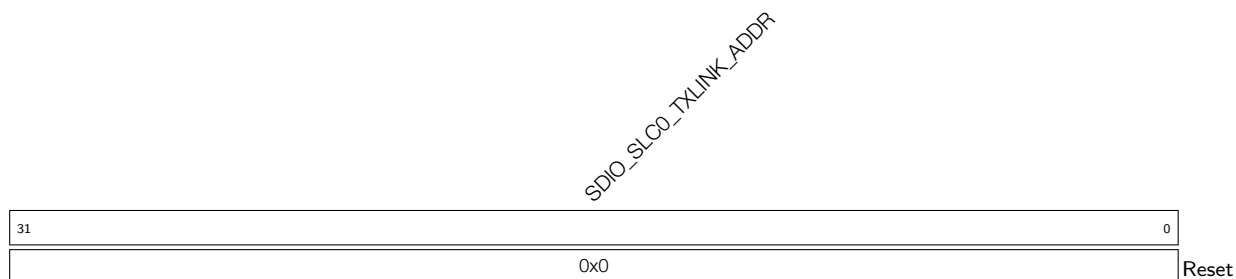

SDIO_SLC0_TXLINK_ADDR Configures SLC0 TX linked list initial address. (R/W)

Register 33.12. SDIO_SLC1RX_LINK_REG (0x004C)

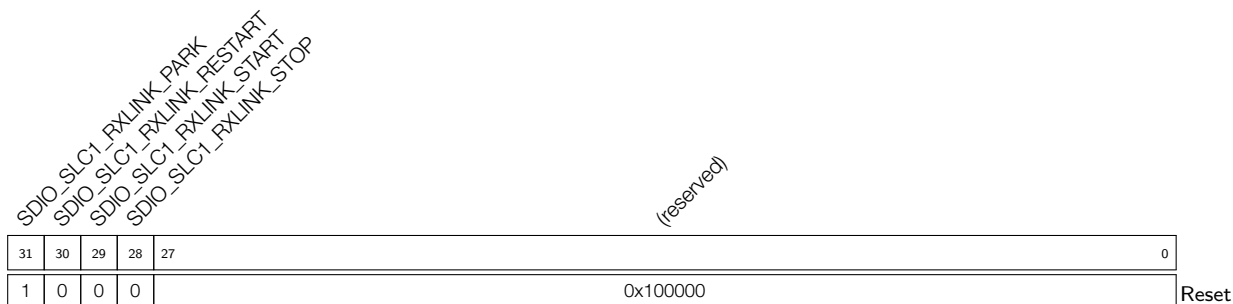

SDIO_SLC1_RXLINK_STOP Configures whether to stop SLC1 RX linked list operation.

- 0: No effect
 - 1: Stop the operation
- (R/W/SC)

SDIO_SLC1_RXLINK_START Configures whether to start SLC1 RX linked list operation from the address indicated by SDIO_SLC1_RXLINK_ADDR.

- 0: No effect
 - 1: Start the operation
- (R/W/SC)

SDIO_SLC1_RXLINK_RESTART Configures whether to restart and continue SLC1 RX linked list operation.

- 0: No effect
 - 1: Restart the operation
- (R/W/SC)

SDIO_SLC1_RXLINK_PARK Represents SLC1 RX linked list FSM state.

- 0: The FSM not in idle state
 - 1: The FSM in idle state
- (RO)

Register 33.13. SDIO_SLC1RX_LINK_ADDR_REG (0x0050)

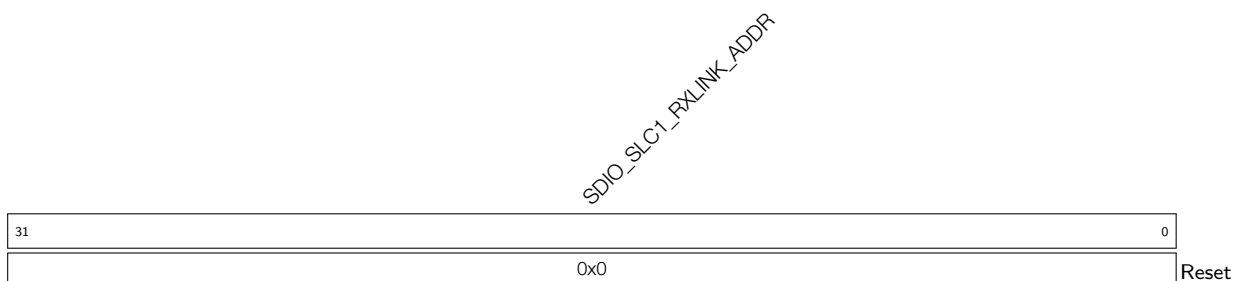

SDIO_SLC1_RXLINK_ADDR Configures SLC1 RX linked list initial address. (R/W)

Register 33.14. SDIO_SLC1TX_LINK_REG (0x0054)

(reserved)					0
31	30	29	28	27	
1	0	0	0	0x0	
					Reset

SDIO_SLC1_TXLINK_STOP Configures whether to stop SLC1 TX linked list operation.

0: No effect

1: Stop the operation

(R/W/SC)

SDIO_SLC1_TXLINK_START Configures whether to start SLC1 TX linked list operation from the address indicated by SDIO_SLC1_TXLINK_ADDR.

0: No effect

1: Start the operation

(R/W/SC)

SDIO_SLC1_TXLINK_RESTART Configures whether to restart and continue SLC1 TX linked list operation.

0: No effect

1: Restart the operation

(R/W/SC)

SDIO_SLC1_TXLINK_PARK Represents SLC1 TX linked list FSM state.

0: The FSM not in idle state

1: The FSM in idle state

(RO)

Register 33.15. SDIO_SLC1TX_LINK_ADDR_REG (0x0058)

(reserved)		0
31		
0x0		Reset

SDIO_SLC1_TXLINK_ADDR Configures SLC1 TX linked list initial address. (R/W)

Register 33.16. SDIO_SLC0TOKEN1_REG (0x0064)

(reserved)		SDIO_SLC0_TOKEN1										(reserved)				SDIO_SLC0_TOKEN1_INC_MORE				SDIO_SLC0_TOKEN1_INC				SDIO_SLC0_TOKEN1_WR				SDIO_SLC0_TOKEN1_WDATA			
31	28	27											16	15	14	13	12	11									0				
0x0		0x0										0				0				0x0				Reset							

SDIO_SLC0_TOKEN1_WDATA Configures SLC0 token 1 value. (WT)

SDIO_SLC0_TOKEN1_WR Configures this bit to 1 to write SDIO_SLC0_TOKEN1_WDATA into SDIO_SLC0_TOKEN1. (WT)

SDIO_SLC0_TOKEN1_INC Configures this bit to 1 to add 1 to SDIO_SLC0_TOKEN1. (WT)

SDIO_SLC0_TOKEN1_INC_MORE Configures this bit to 1 to add the value of SDIO_SLC0_TOKEN1_WDATA to SDIO_SLC0_TOKEN1. (WT)

SDIO_SLC0_TOKEN1 Represents the SLC0 accumulated number of buffers for receiving packets. (RO)

Register 33.17. SDIO_SLC1TOKEN1_REG (0x006C)

(reserved)		SDIO_SLC1_TOKEN1										(reserved)				SDIO_SLC1_TOKEN1_INC_MORE				SDIO_SLC1_TOKEN1_INC				SDIO_SLC1_TOKEN1_WR				SDIO_SLC1_TOKEN1_WDATA			
31	28	27											16	15	14	13	12	11									0				
0x0		0x0										0				0				0x0				Reset							

SDIO_SLC1_TOKEN1_WDATA Configures SLC1 token1 value. (WT)

SDIO_SLC1_TOKEN1_WR Configures this bit to 1 to write SDIO_SLC1_TOKEN1_WDATA into SDIO_SLC1_TOKEN1. (WT)

SDIO_SLC1_TOKEN1_INC Configures this bit to 1 to add 1 to SDIO_SLC1_TOKEN1. (WT)

SDIO_SLC1_TOKEN1_INC_MORE Configures this bit to 1 to add the value of SDIO_SLC1_TOKEN1_WDATA to SDIO_SLC1_TOKEN1. (WT)

SDIO_SLC1_TOKEN1 Represents SLC1 accumulated number of buffers for receiving packets. (RO)

Register 33.18. SDIO_SLCCONF1_REG (0x0070)

(reserved)	22	21	20	19	18	7	6	5	4	3	2	0					
	SDIO_SLC1_RX_STITCH_EN SDIO_SLC1_TX_STITCH_EN SDIO_HOST_INT_LEVEL_SEL				(reserved)	SDIO_SLC0_RX_STITCH_EN SDIO_SLC0_TX_STITCH_EN SDIO_SLC0_LEN_AUTO_CLR SDIO_SDIO_CMD_HOLD_EN				(reserved)							
31	0x0				1	1	0	0x0				1	1	1	1	0x0	Reset

SDIO_SDIO_CMD_HOLD_EN Please initialize to 0, and do not modify it. (R/W)

SDIO_SLC0_LEN_AUTO_CLR Please initialize to 0, and do not modify it. (R/W)

SDIO_SLC0_TX_STITCH_EN Please initialize to 0, and do not modify it. (R/W)

SDIO_SLC0_RX_STITCH_EN Please initialize to 0, and do not modify it. (R/W)

SDIO_HOST_INT_LEVEL_SEL Configures the polarity of interrupt to host.

0: Low active

1: High active

(R/W)

SDIO_SLC1_TX_STITCH_EN Please initialize to 0, and do not modify it. (R/W)

SDIO_SLC1_RX_STITCH_EN Please initialize to 0, and do not modify it. (R/W)

Register 33.19. SDIO_SLC_RX_DSCR_CONF_REG (0x00A8)

(reserved)	31	1	0	
	0x101b80d		0	Reset

SDIO_SLC0_TOKEN_NO_REPLACE Please initialize to 1, and do not modify it. (R/W)

Register 33.20. SDIO_SLC0_LEN_CONF_REG (0x00F4)

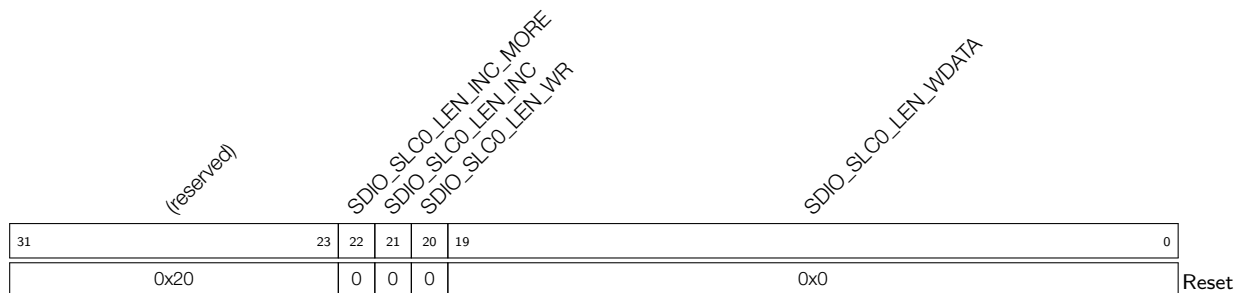

SDIO_SLC0_LEN_WDATA Configures the length of the data that the slave wants to send. (WT)

SDIO_SLC0_LEN_WR Configures this bit to 1 to write SDIO_SLC0_LEN_WDATA into SDIO_SLC0_LEN and SLCHOST_HOSTSLCHOST_SLC0_LEN. (WT)

SDIO_SLC0_LEN_INC Configures this bit to 1 to add 1 to SDIO_SLC0_LEN and SLCHOST_HOSTSLCHOST_SLC0_LEN. (WT)

SDIO_SLC0_LEN_INC_MORE Configures this bit to 1 to add the value of SDIO_SLC0_LEN_WDATA to SDIO_SLC0_LEN and SLCHOST_HOSTSLCHOST_SLC0_LEN. (WT)

Register 33.21. SDIO_SLC0_TX_SHAREMEM_START_REG (0x0154)

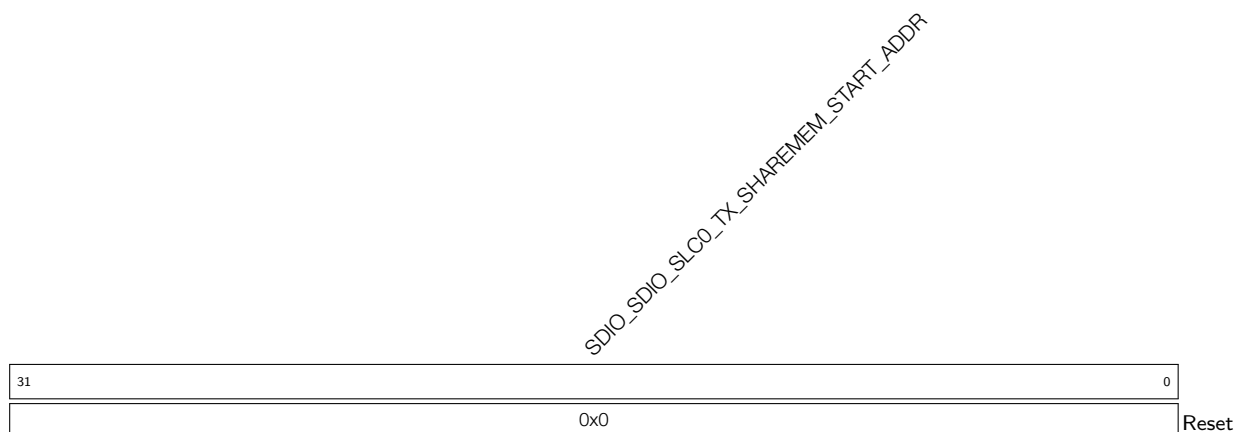

SDIO_SDIO_SLC0_TX_SHAREMEM_START_ADDR Configures SLC0 host to slave channel AHB start address boundary. (R/W)

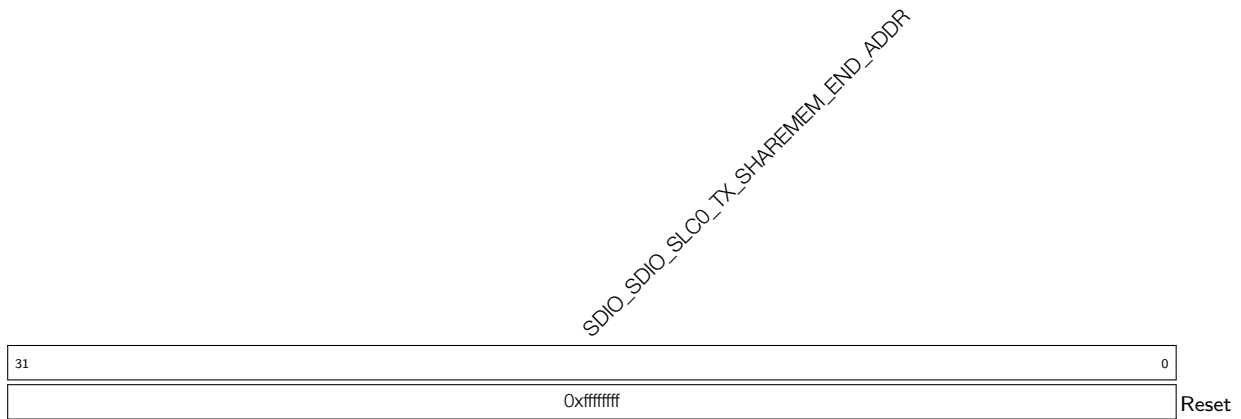
Register 33.22. SDIO_SLC0_TX_SHAREMEM_END_REG (0x0158)

SDIO_SLC0_TX_SHAREMEM_END_ADDR Configures SLC0 host to slave channel AHB end address boundary. (R/W)

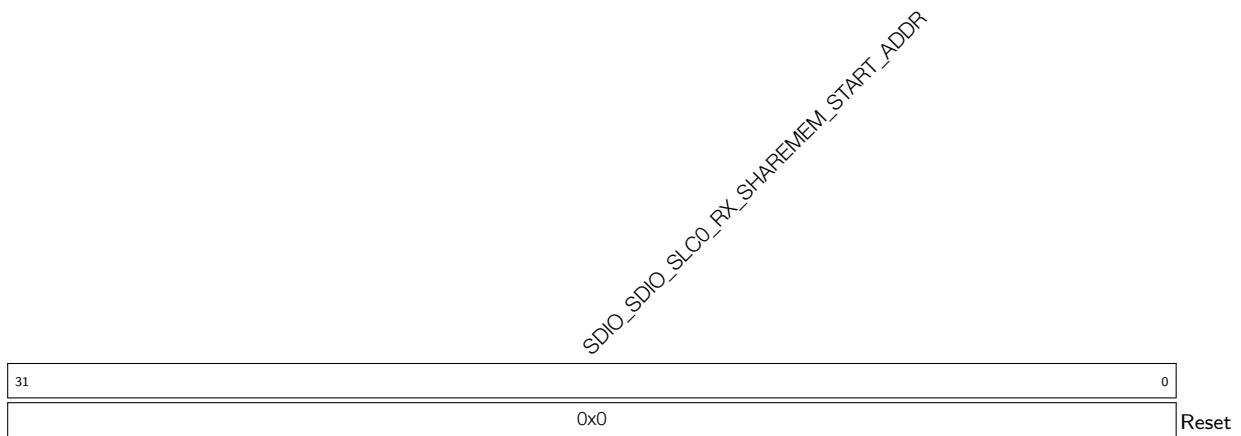
Register 33.23. SDIO_SLC0_RX_SHAREMEM_START_REG (0x015C)

SDIO_SLC0_RX_SHAREMEM_START_ADDR Configures SLC0 slave to host channel AHB start address boundary. (R/W)

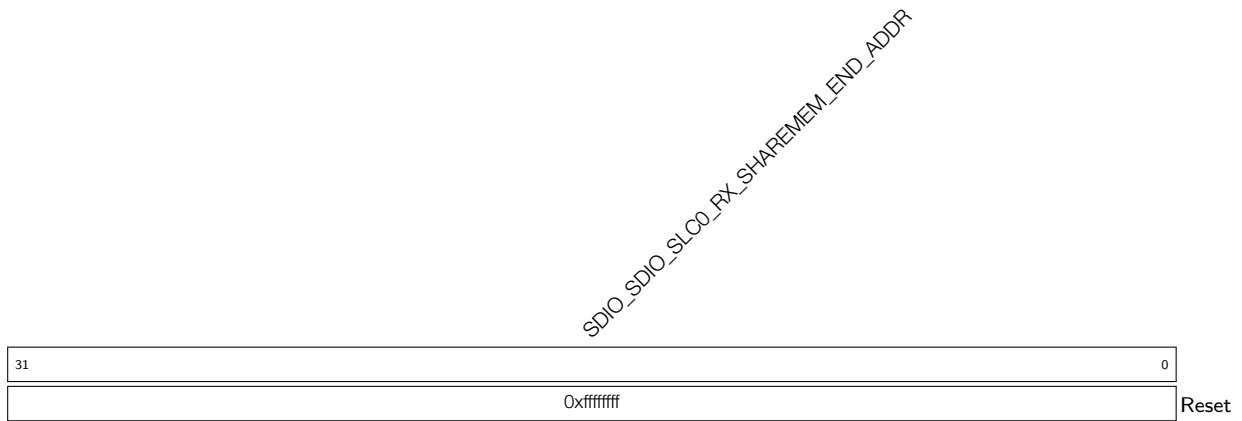
Register 33.24. SDIO_SLC0_RX_SHAREMEM_END_REG (0x0160)

SDIO_SLC0_RX_SHAREMEM_END_ADDR Configures SLC0 slave to host channel AHB end address boundary. (R/W)

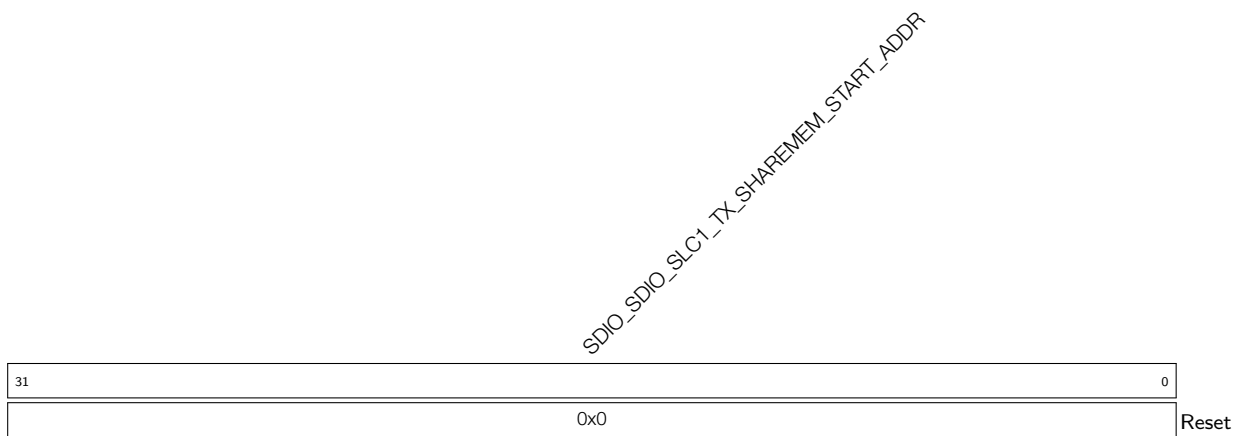
Register 33.25. SDIO_SLC1_TX_SHAREMEM_START_REG (0x0164)

SDIO_SLC1_TX_SHAREMEM_START_ADDR Configures SLC1 host to slave channel AHB start address boundary. (R/W)

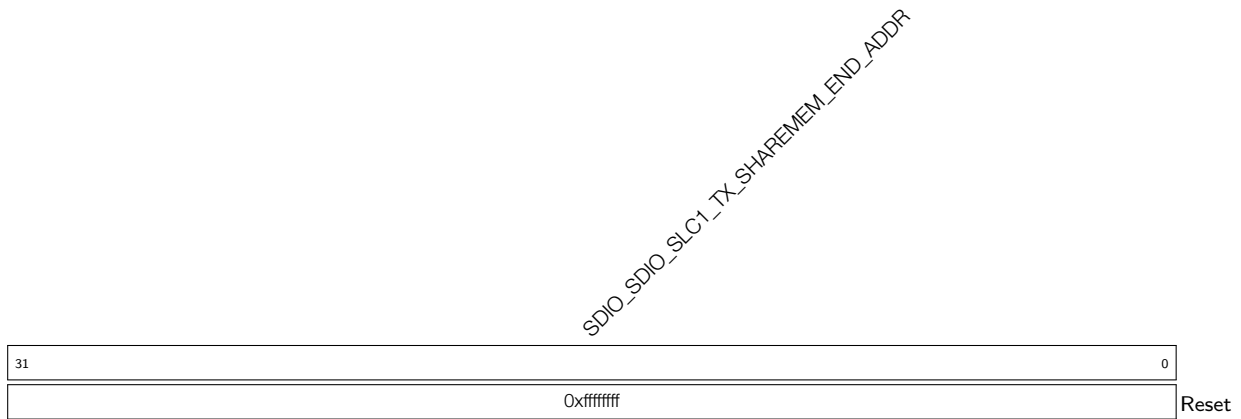
Register 33.26. SDIO_SLC1_TX_SHAREMEM_END_REG (0x0168)

SDIO_SLC1_TX_SHAREMEM_END_ADDR Configures SLC1 host to slave channel AHB end address boundary. (R/W)

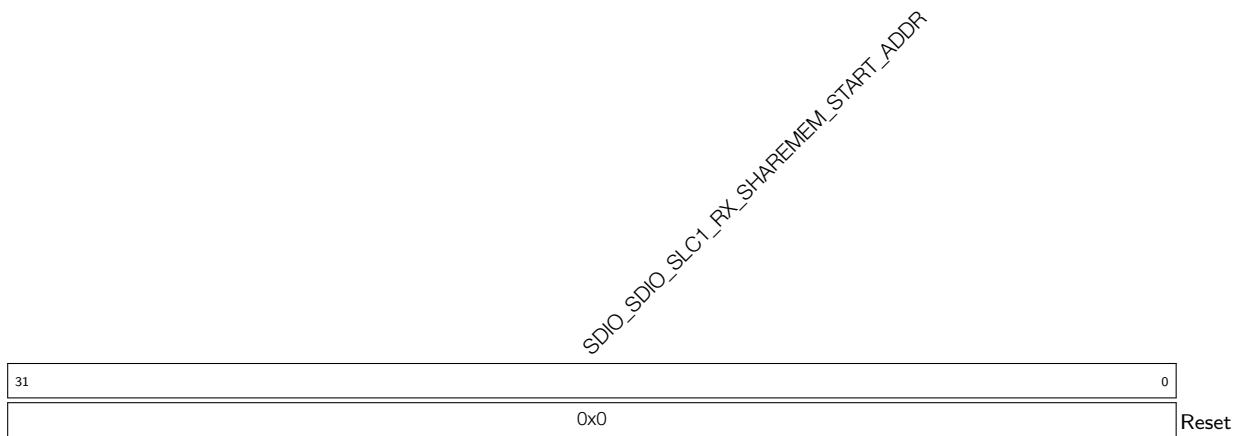
Register 33.27. SDIO_SLC1_RX_SHAREMEM_START_REG (0x016C)

SDIO_SLC1_RX_SHAREMEM_START_ADDR Configures SLC1 slave to host channel AHB start address boundary. (R/W)

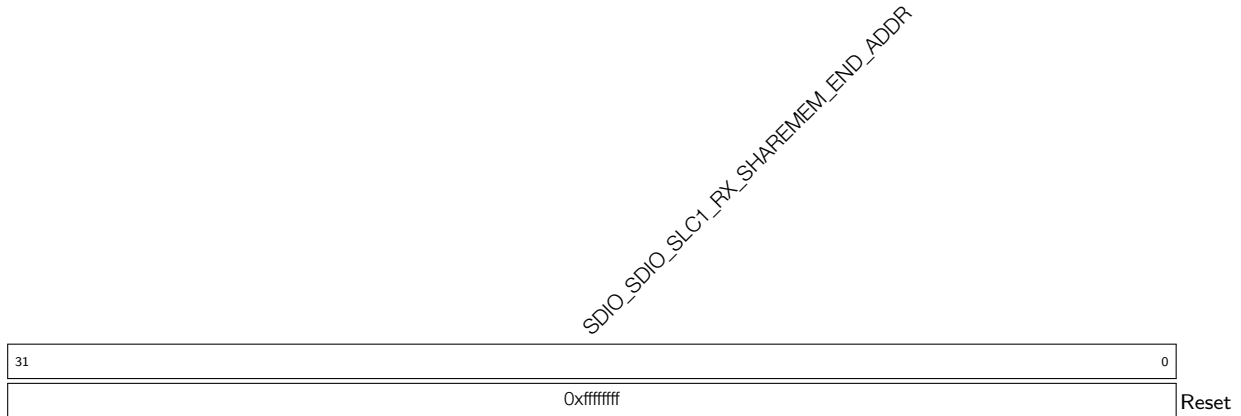
Register 33.28. SDIO_SLC1_RX_SHAREMEM_END_REG (0x0170)

SDIO_SLC1_RX_SHAREMEM_END_ADDR Configures SLC1 slave to host channel AHB end address boundary. (R/W)

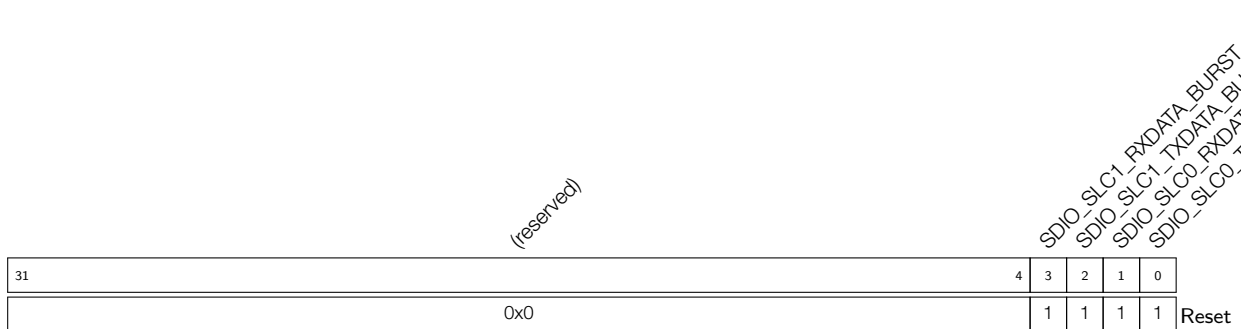
Register 33.29. SDIO_SLC_BURST_LEN_REG (0x017C)

SDIO_SLC0_TXDATA_BURST_LEN Configures SLC0 host to slave channel AHB burst type.

0: Can use incr4

1: Can use incr8

(R/W)

SDIO_SLC0_RXDATA_BURST_LEN Configures SLC0 slave to host channel AHB burst type.

0: Can use incr and incr4

1: Can use incr and incr8

(R/W)

SDIO_SLC1_TXDATA_BURST_LEN Configures SLC1 host to slave channel AHB burst type.

0: Can use incr4

1: Can use incr8

(R/W)

SDIO_SLC1_RXDATA_BURST_LEN Configures SLC1 slave to host channel AHB burst type.

0: Can use incr and incr4

1: Can use incr and incr8

(R/W)

Register 33.30. SDIO_SLC0INT_RAW_REG (0x0004)

(reserved)	SDIO_SLC0_RX_DSCR_ERR_INT_RAW	SDIO_SLC0_TX_DSCR_ERR_INT_RAW	(reserved)	SDIO_SLC0_RX_EOF_INT_RAW	SDIO_SLC0_RX_DONE_INT_RAW	SDIO_SLC0_TX_SUC_EOF_INT_RAW	(reserved)	SDIO_SLC0_TX_OVF_INT_RAW	SDIO_SLC0_RX_UDF_INT_RAW	SDIO_SLC0_TX_START_INT_RAW	SDIO_SLC0_RX_START_INT_RAW	SDIO_SLC_FRHOST_BIT7_INT_RAW	SDIO_SLC_FRHOST_BIT6_INT_RAW	SDIO_SLC_FRHOST_BIT5_INT_RAW	SDIO_SLC_FRHOST_BIT4_INT_RAW	SDIO_SLC_FRHOST_BIT3_INT_RAW	SDIO_SLC_FRHOST_BIT2_INT_RAW	SDIO_SLC_FRHOST_BIT1_INT_RAW	SDIO_SLC_FRHOST_BIT0_INT_RAW			
31	21	20	19	18	17	16	15	14	13	12	11	10	9	8	7	6	5	4	3	2	1	0
0x0		0	0	0	0	0	0	0	0x0	0	0	0	0	0	0	0	0	0	0	0	0	0

Reset

SDIO_SLC_FRHOST_BIT n _INT_RAW (n : 0-7) The raw interrupt status of [SLC_FRHOST_BIT \$n\$ _INT](#) (n : 0-7). (R/WTC/SS)

SDIO_SLC0_RX_START_INT_RAW The raw interrupt status of [SLC0_RX_START_INT](#). (R/WTC/SS)

SDIO_SLC0_TX_START_INT_RAW The raw interrupt status of [SLC0_TX_START_INT](#). (R/WTC/SS)

SDIO_SLC0_RX_UDF_INT_RAW The raw interrupt status of [SLC0_RX_UDF_INT](#). (R/WTC/SS)

SDIO_SLC0_TX_OVF_INT_RAW The raw interrupt status of [SLC0_TX_OVF_INT](#). (R/WTC/SS)

SDIO_SLC0_TX_DONE_INT_RAW The raw interrupt status of [SLC0_TX_DONE_INT](#). (R/WTC/SS)

SDIO_SLC0_TX_SUC_EOF_INT_RAW The raw interrupt status of [SLC0_TX_SUC_EOF_INT](#). (R/WTC/SS)

SDIO_SLC0_RX_DONE_INT_RAW The raw interrupt status of [SLC0_RX_DONE_INT](#). (R/WTC/SS)

SDIO_SLC0_RX_EOF_INT_RAW The raw interrupt status of [SLC0_RX_EOF_INT](#). (R/WTC/SS)

SDIO_SLC0_TX_DSCR_ERR_INT_RAW The raw interrupt status of [SLC0_TX_DSCR_ERR_INT](#). (R/WTC/SS)

SDIO_SLC0_RX_DSCR_ERR_INT_RAW The raw interrupt status of [SLC0_RX_DSCR_ERR_INT](#). (R/WTC/SS)

Register 33.31. SDIO_SLC0INT_ST_REG (0x0008)

31	21	20	19	18	17	16	15	14	13	12	11	10	9	8	7	6	5	4	3	2	1	0
0x0		0	0	0	0	0	0	0	0x0	0	0	0	0	0	0	0	0	0	0	0	0	0

Reset

SDIO_SLC_FRHOST_BIT n _INT_ST (n : 0-7) The masked interrupt status of [SLC_FRHOST_BIT \$n\$ _INT \(\$n\$: 0-7\)](#). (RO)

SDIO_SLC0_RX_START_INT_ST The masked interrupt status of [SLC0_RX_START_INT](#). (RO)

SDIO_SLC0_TX_START_INT_ST The masked interrupt status bit of [SLC0_TX_START_INT](#). (RO)

SDIO_SLC0_RX_UDF_INT_ST The masked interrupt status of [SLC0_RX_UDF_INT](#). (RO)

SDIO_SLC0_TX_OVF_INT_ST The masked interrupt status of [SLC0_TX_OVF_INT](#). (RO)

SDIO_SLC0_TX_DONE_INT_ST The masked interrupt status of [SLC0_TX_DONE_INT](#). (RO)

SDIO_SLC0_TX_SUC_EOF_INT_ST The masked interrupt status of [SLC0_TX_SUC_EOF_INT](#). (RO)

SDIO_SLC0_RX_DONE_INT_ST The masked interrupt status of [SLC0_RX_DONE_INT](#). (RO)

SDIO_SLC0_RX_EOF_INT_ST The masked interrupt status bit of [SLC0_RX_EOF_INT](#). (RO)

SDIO_SLC0_TX_DSCR_ERR_INT_ST The masked interrupt status of [SLC0_TX_DSCR_ERR_INT](#). (RO)

SDIO_SLC0_RX_DSCR_ERR_INT_ST The masked interrupt status of [SLC0_RX_DSCR_ERR_INT](#). (RO)

Register 33.32. SDIO_SLC0INT_ENA_REG (0x000C)

(reserved)	SDIO_SLC0_RX_DSCR_ERR_INT_ENA	SDIO_SLC0_TX_DSCR_ERR_INT_ENA	(reserved)	SDIO_SLC0_RX_EOF_INT_ENA	SDIO_SLC0_RX_DONE_INT_ENA	SDIO_SLC0_TX_SUC_EOF_INT_ENA	SDIO_SLC0_TX_DONE_INT_ENA	(reserved)	SDIO_SLC0_TX_OVF_INT_ENA	SDIO_SLC0_RX_UDF_INT_ENA	SDIO_SLC0_TX_START_INT_ENA	SDIO_SLC0_RX_START_INT_ENA	SDIO_SLC_FRHOST_BIT7_INT_ENA	SDIO_SLC_FRHOST_BIT6_INT_ENA	SDIO_SLC_FRHOST_BIT5_INT_ENA	SDIO_SLC_FRHOST_BIT4_INT_ENA	SDIO_SLC_FRHOST_BIT3_INT_ENA	SDIO_SLC_FRHOST_BIT2_INT_ENA	SDIO_SLC_FRHOST_BIT1_INT_ENA	SDIO_SLC_FRHOST_BIT0_INT_ENA		
31	21	20	19	18	17	16	15	14	13	12	11	10	9	8	7	6	5	4	3	2	1	0
0x0		0	0	0	0	0	0	0	0x0	0	0	0	0	0	0	0	0	0	0	0	0	0

Reset

SDIO_SLC_FRHOST_BIT n _INT_ENA (n : 0-7) Write 1 to enable interrupt [SLC_FRHOST_BIT \$n\$ _INT](#) (n : 0-7). (R/W)

SDIO_SLC0_RX_START_INT_ENA Write 1 to enable interrupt [SLC0_RX_START_INT](#). (R/W)

SDIO_SLC0_TX_START_INT_ENA Write 1 to enable interrupt [SLC0_TX_START_INT](#). (R/W)

SDIO_SLC0_RX_UDF_INT_ENA Write 1 to enable interrupt [SLC0_RX_UDF_INT](#). (R/W)

SDIO_SLC0_TX_OVF_INT_ENA Write 1 to enable interrupt [SLC0_TX_OVF_INT](#). (R/W)

SDIO_SLC0_TX_DONE_INT_ENA Write 1 to enable interrupt [SLC0_TX_DONE_INT](#). (R/W)

SDIO_SLC0_TX_SUC_EOF_INT_ENA Write 1 to enable interrupt [SLC0_TX_SUC_EOF_INT](#). (R/W)

SDIO_SLC0_RX_DONE_INT_ENA Write 1 to enable interrupt [SLC0_RX_DONE_INT](#). (R/W)

SDIO_SLC0_RX_EOF_INT_ENA Write 1 to enable interrupt [SLC0_RX_EOF_INT](#). (R/W)

SDIO_SLC0_TX_DSCR_ERR_INT_ENA Write 1 to enable interrupt [SLC0_TX_DSCR_ERR_INT](#). (R/W)

SDIO_SLC0_RX_DSCR_ERR_INT_ENA Write 1 to enable interrupt [SLC0_RX_DSCR_ERR_INT](#). (R/W)

Register 33.33. SDIO_SLC0INT_CLR_REG (0x0010)

(reserved)																					SDIO_SLC0_RX_DSCR_ERR_INT_CLR	SDIO_SLC0_TX_DSCR_ERR_INT_CLR	(reserved)		SDIO_SLC0_RX_EOF_INT_CLR	SDIO_SLC0_RX_DONE_INT_CLR	SDIO_SLC0_TX_SUC_EOF_INT_CLR	(reserved)		SDIO_SLC0_TX_OVF_INT_CLR	SDIO_SLC0_RX_UDF_INT_CLR	SDIO_SLC0_TX_START_INT_CLR	SDIO_SLC0_RX_START_INT_CLR	SDIO_SLC_FRHOST_BIT7_INT_CLR	SDIO_SLC_FRHOST_BIT6_INT_CLR	SDIO_SLC_FRHOST_BIT5_INT_CLR	SDIO_SLC_FRHOST_BIT4_INT_CLR	SDIO_SLC_FRHOST_BIT3_INT_CLR	SDIO_SLC_FRHOST_BIT2_INT_CLR	SDIO_SLC_FRHOST_BIT1_INT_CLR	SDIO_SLC_FRHOST_BIT0_INT_CLR
31	21	20	19	18	17	16	15	14	13	12	11	10	9	8	7	6	5	4	3	2	1	0																			
0x0		0	0	0	0	0	0	0	0x0	0	0	0	0	0	0	0	0	0	0	0	0	0																			

Reset

SDIO_SLC_FRHOST_BIT n _INT_CLR (n : 0-7) Write 1 to clear interrupt [SLC_FRHOST_BIT \$n\$ _INT \(\$n\$: 0-7\)](#).(WT)

SDIO_SLC0_RX_START_INT_CLR Write 1 to clear interrupt [SLC0_RX_START_INT](#). (WT)

SDIO_SLC0_TX_START_INT_CLR Write 1 to clear interrupt [SLC0_TX_START_INT](#). (WT)

SDIO_SLC0_RX_UDF_INT_CLR Write 1 to clear interrupt [SLC0_RX_UDF_INT](#). (WT)

SDIO_SLC0_TX_OVF_INT_CLR Write 1 to clear interrupt [SLC0_TX_OVF_INT](#). (WT)

SDIO_SLC0_TX_DONE_INT_CLR Write 1 to clear interrupt [SLC0_TX_DONE_INT](#). (WT)

SDIO_SLC0_TX_SUC_EOF_INT_CLR Write 1 to clear interrupt [SLC0_TX_SUC_EOF_INT](#). (WT)

SDIO_SLC0_RX_DONE_INT_CLR Write 1 to clear interrupt [SLC0_RX_DONE_INT](#). (WT)

SDIO_SLC0_RX_EOF_INT_CLR Write 1 to clear interrupt [SLC0_RX_EOF_INT](#). (WT)

SDIO_SLC0_TX_DSCR_ERR_INT_CLR Write 1 to clear interrupt [SLC0_TX_DSCR_ERR_INT](#). (WT)

SDIO_SLC0_RX_DSCR_ERR_INT_CLR Write 1 to clear interrupt [SLC0_RX_DSCR_ERR_INT](#). (WT)

Register 33.34. SDIO_SLC1INT_RAW_REG (0x0014)

31	21	20	19	18	17	16	15	14	13	12	11	10	9	8	7	6	5	4	3	2	1	0
0x0		0	0	0	0	0	0	0	0x0	0	0	0	0	0	0	0	0	0	0	0	0	0

Reset

SDIO_SLC_FRHOST_BIT n _INT_RAW (n : 8-15) The raw interrupt status of **SLC_FRHOST_BIT n _INT** (n : 8-15). (R/WTC/SS)

SDIO_SLC1_RX_START_INT_RAW The raw interrupt status of **SLC1_RX_START_INT**. (R/WTC/SS)

SDIO_SLC1_TX_START_INT_RAW The raw interrupt status of **SLC1_TX_START_INT**. (R/WTC/SS)

SDIO_SLC1_RX_UDF_INT_RAW The raw interrupt status of **SLC1_RX_UDF_INT**. (R/WTC/SS)

SDIO_SLC1_TX_OVF_INT_RAW The raw interrupt status of **SLC1_TX_OVF_INT**. (R/WTC/SS)

SDIO_SLC1_TX_DONE_INT_RAW The raw interrupt status of **SLC1_TX_DONE_INT**. (R/WTC/SS)

SDIO_SLC1_TX_SUC_EOF_INT_RAW The raw interrupt status of **SLC1_TX_SUC_EOF_INT**. (R/WTC/SS)

SDIO_SLC1_RX_DONE_INT_RAW The raw interrupt status of **SLC1_RX_DONE_INT**. (R/WTC/SS)

SDIO_SLC1_RX_EOF_INT_RAW The raw interrupt status of **SLC1_RX_EOF_INT**. (R/WTC/SS)

SDIO_SLC1_TX_DSCR_ERR_INT_RAW The raw interrupt status of **SLC1_TX_DSCR_ERR_INT**. (R/WTC/SS)

SDIO_SLC1_RX_DSCR_ERR_INT_RAW The raw interrupt status of **SLC1_RX_DSCR_ERR_INT**. (R/WTC/SS)

Register 33.35. SDIO_SLC1INT_CLR_REG (0x0020)

(reserved)																					SDIO_SLC1_RX_DSCR_ERR_INT_CLR	SDIO_SLC1_TX_DSCR_ERR_INT_CLR	(reserved)		SDIO_SLC1_RX_EOF_INT_CLR	SDIO_SLC1_TX_DONE_INT_CLR	(reserved)		SDIO_SLC1_TX_OVF_INT_CLR	SDIO_SLC1_RX_UDF_INT_CLR	SDIO_SLC1_TX_START_INT_CLR	SDIO_SLC1_RX_FRHOST_INT_CLR	SDIO_SLC1_TX_FRHOST_INT_CLR	SDIO_SLC1_FRHOST_BIT15_INT_CLR	SDIO_SLC1_FRHOST_BIT14_INT_CLR	SDIO_SLC1_FRHOST_BIT13_INT_CLR	SDIO_SLC1_FRHOST_BIT12_INT_CLR	SDIO_SLC1_FRHOST_BIT11_INT_CLR	SDIO_SLC1_FRHOST_BIT10_INT_CLR	SDIO_SLC1_FRHOST_BIT9_INT_CLR	SDIO_SLC1_FRHOST_BIT8_INT_CLR	SDIO_SLC1_FRHOST_BIT7_INT_CLR	SDIO_SLC1_FRHOST_BIT6_INT_CLR	SDIO_SLC1_FRHOST_BIT5_INT_CLR	SDIO_SLC1_FRHOST_BIT4_INT_CLR	SDIO_SLC1_FRHOST_BIT3_INT_CLR	SDIO_SLC1_FRHOST_BIT2_INT_CLR	SDIO_SLC1_FRHOST_BIT1_INT_CLR	SDIO_SLC1_FRHOST_BIT0_INT_CLR	Reset		
31	21	20	19	18	17	16	15	14	13	12	11	10	9	8	7	6	5	4	3	2	1	0																														
0x0																					0	0	0	0	0	0	0	0	0x0	0	0	0	0	0	0	0	0	0	0	0	0	0	0	0	0	0	0	0	0	0	0	Reset

SDIO_SLC_FRHOST_BIT n _INT_CLR (n : 8-15) Write 1 to clear interrupt **SLC_FRHOST_BIT n _INT** (n : 8-15). (WT)

SDIO_SLC1_RX_START_INT_CLR Write 1 to clear interrupt **SLC1_RX_START_INT**. (WT)

SDIO_SLC1_TX_START_INT_CLR Write 1 to clear interrupt **SLC1_TX_START_INT**. (WT)

SDIO_SLC1_RX_UDF_INT_CLR Write 1 to clear interrupt **SLC1_RX_UDF_INT**. (WT)

SDIO_SLC1_TX_OVF_INT_CLR Write 1 to clear interrupt **SLC1_TX_OVF_INT**. (WT)

SDIO_SLC1_TX_DONE_INT_CLR Write 1 to clear interrupt **SLC1_TX_DONE_INT**. (WT)

SDIO_SLC1_TX_SUC_EOF_INT_CLR Write 1 to clear interrupt **SLC1_TX_SUC_EOF_INT**. (WT)

SDIO_SLC1_RX_DONE_INT_CLR Write 1 to clear interrupt **SLC1_RX_DONE_INT**. (WT)

SDIO_SLC1_RX_EOF_INT_CLR Write 1 to clear interrupt **SLC1_RX_EOF_INT**. (WT)

SDIO_SLC1_TX_DSCR_ERR_INT_CLR Write 1 to clear interrupt **SLC1_TX_DSCR_ERR_INT**. (WT)

SDIO_SLC1_RX_DSCR_ERR_INT_CLR Write 1 to clear interrupt **SLC1_RX_DSCR_ERR_INT**. (WT)

Register 33.36. SDIO_SLCINTVEC_TOHOST_REG (0x005C)

(reserved)				SDIO_SLC1_TOHOST_INTVEC	(reserved)				SDIO_SLC0_TOHOST_INTVEC	
31	24	23	16	15	8	7				0
0x0				0x0	0x0				0x0	Reset

SDIO_SLC0_TOHOST_INTVEC The interrupt set bit of **SLCHOST_SLC0_TOHOST_BIT n _INT** (n : 0-7). These bits will be cleared automatically. (WT)

SDIO_SLC1_TOHOST_INTVEC The interrupt set bit of **SLCHOST_SLC1_TOHOST_BIT n _INT** (n : 0-7). These bits will be cleared automatically. (WT)

Register 33.37. SDIO_SLC1INT_ST1_REG (0x014C)

31	21	20	19	18	17	16	15	14	13	12	11	10	9	8	7	6	5	4	3	2	1	0	
(reserved)										(reserved)													
0x0		0	0	0	0	0	0	0	0	0	0	0	0	0	0	0	0	0	0	0	0	0	
																						Reset	

SDIO_SLC_FRHOST_BIT n _INT_ST1 (n : 8-15) The masked interrupt status of SLC_FRHOST_BIT n _INT (n : 8-15). (RO)

SDIO_SLC1_RX_START_INT_ST1 The masked interrupt status of SLC1_RX_START_INT. (RO)

SDIO_SLC1_TX_START_INT_ST1 The masked interrupt status of SLC1_TX_START_INT. (RO)

SDIO_SLC1_RX_UDF_INT_ST1 The masked interrupt status of SLC1_RX_UDF_INT. (RO)

SDIO_SLC1_TX_OVF_INT_ST1 The masked interrupt status of SLC1_TX_OVF_INT. (RO)

SDIO_SLC1_TX_DONE_INT_ST1 The masked interrupt status of SLC1_TX_DONE_INT. (RO)

SDIO_SLC1_TX_SUC_EOF_INT_ST1 The masked interrupt status of SLC1_TX_SUC_EOF_INT. (RO)

SDIO_SLC1_RX_DONE_INT_ST1 The masked interrupt status of SLC1_RX_DONE_INT. (RO)

SDIO_SLC1_RX_EOF_INT_ST1 The masked interrupt status of SLC1_RX_EOF_INT. (RO)

SDIO_SLC1_TX_DSCR_ERR_INT_ST1 The masked interrupt status of SLC1_TX_DSCR_ERR_INT. (RO)

SDIO_SLC1_RX_DSCR_ERR_INT_ST1 The masked interrupt status of SLC1_RX_DSCR_ERR_INT. (RO)

Register 33.38. SDIO_SLC1INT_ENA1_REG (0x0150)

(reserved)		SDIO_SLC1_RX_DSCR_ERR_INT_ENA1 SDIO_SLC1_TX_DSCR_ERR_INT_ENA1 (reserved) SDIO_SLC1_RX_EOF_INT_ENA1 SDIO_SLC1_RX_DONE_INT_ENA1 SDIO_SLC1_TX_SUC_EOF_INT_ENA1 SDIO_SLC1_TX_DONE_INT_ENA1 (reserved) SDIO_SLC1_TX_OVF_INT_ENA1 SDIO_SLC1_RX_UDF_INT_ENA1 SDIO_SLC1_TX_START_INT_ENA1 SDIO_SLC1_RX_START_INT_ENA1 SDIO_SLC_FRHOST_BIT15_INT_ENA1 SDIO_SLC_FRHOST_BIT14_INT_ENA1 SDIO_SLC_FRHOST_BIT13_INT_ENA1 SDIO_SLC_FRHOST_BIT12_INT_ENA1 SDIO_SLC_FRHOST_BIT11_INT_ENA1 SDIO_SLC_FRHOST_BIT10_INT_ENA1 SDIO_SLC_FRHOST_BIT9_INT_ENA1 SDIO_SLC_FRHOST_BIT8_INT_ENA1																					
31	21	20	19	18	17	16	15	14	13	12	11	10	9	8	7	6	5	4	3	2	1	0	
0x0		0	0	0	0	0	0	0	0x0	0	0	0	0	0	0	0	0	0	0	0	0	0	0

Reset

SDIO_SLC_FRHOST_BIT n _INT_ENA1 (n : 8-15) Write 1 to enable interrupt **SLC_FRHOST_BIT n _INT** (n : 8-15). (R/W)

SDIO_SLC1_RX_START_INT_ENA1 Write 1 to enable interrupt **SLC1_RX_START_INT**. (R/W)

SDIO_SLC1_TX_START_INT_ENA1 Write 1 to enable interrupt **SLC1_TX_START_INT**. (R/W)

SDIO_SLC1_RX_UDF_INT_ENA1 Write 1 to enable interrupt **SLC1_RX_UDF_INT**. (R/W)

SDIO_SLC1_TX_OVF_INT_ENA1 Write 1 to enable interrupt **SLC1_TX_OVF_INT**. (R/W)

SDIO_SLC1_TX_DONE_INT_ENA1 Write 1 to enable interrupt **SLC1_TX_DONE_INT**. (R/W)

SDIO_SLC1_TX_SUC_EOF_INT_ENA1 Write 1 to enable interrupt **SLC1_TX_SUC_EOF_INT**. (R/W)

SDIO_SLC1_RX_DONE_INT_ENA1 Write 1 to enable interrupt **SLC1_RX_DONE_INT**. (R/W)

SDIO_SLC1_RX_EOF_INT_ENA1 Write 1 to enable interrupt **SLC1_RX_EOF_INT**. (R/W)

SDIO_SLC1_TX_DSCR_ERR_INT_ENA1 Write 1 to enable interrupt **SLC1_TX_DSCR_ERR_INT**. (R/W)

SDIO_SLC1_RX_DSCR_ERR_INT_ENA1 Write 1 to enable interrupt **SLC1_RX_DSCR_ERR_INT**. (R/W)

Register 33.39. SDIO_SLC0_LENGTH_REG (0x00F8)

(reserved)		SDIO_SLC0_LEN	
31	20	19	0
0x0		0x0	

Reset

SDIO_SLC0_LEN Represents the accumulated length of data that the slave wants to send. (RO)

33.9.3 SLC Host Registers

Register 33.40. SLCHOST_CONF_REG (0x01F0)

(reserved)				SLCHOST_HSPEED_CON_EN				(reserved)				SLCHOST_FRC_POS_SAMP				SLCHOST_FRC_NEG_SAMP				SLCHOST_FRC_SDIO20				SLCHOST_FRC_SDIO11				
31	28	27	26	20	19	15	14	10	9	5	4	0	31	28	27	26	20	19	15	14	10	9	5	4	0			
0x0				0				0x0				0x0				0x0				0x0				0x0				Reset

SLCHOST_FRC_SDIO11 Configure 1 to bit[4] to force drive CMD signal at the falling clock edge. Configures 1 to bit[3:0] corresponding bit to force drive DAT[3:0] signal corresponding bit at the falling clock edge. (R/W)

SLCHOST_FRC_SDIO20 Configure 1 to bit[4] to force drive CMD signal at the rising clock edge. Configures 1 to bit[3:0] corresponding bit to force drive DAT[3:0] signal corresponding bit at the rising clock edge. (R/W)

SLCHOST_FRC_NEG_SAMP Configure 1 to bit[4] to force sample CMD signal at the falling clock edge. Configures 1 to bit[3:0] corresponding bit to force sample DAT[3:0] signal corresponding bit at the falling clock edge. (R/W)

SLCHOST_FRC_POS_SAMP Configure 1 to bit[4] to force sample CMD signal at the rising clock edge. Configures 1 to bit[3:0] corresponding bit to force sample DAT[3:0] signal corresponding bit at the rising clock edge. (R/W)

SLCHOST_HSPEED_CON_EN Configures 1 to this bit, configures 1 to [HINF_HIGH_SPEED_ENABLE](#), and then the host configures 1 to EHS in CCCR to force drive CMD and DAT signals at the rising clock edge. (R/W)

Register 33.41. SLCHOST_SLC0HOST_INT_RAW_REG (0x0050)

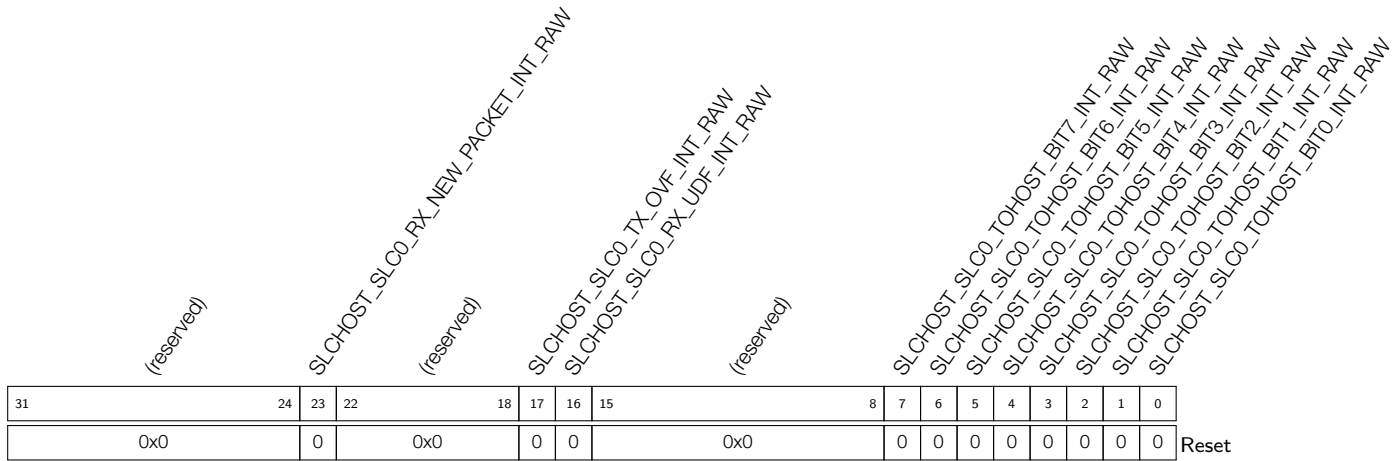

SLCHOST_SLC0_TOHOST_BIT n _INT_RAW (n : 0-7) The raw interrupt status of [SLCHOST_SLC0_TOHOST_BIT \$n\$ _INT \(\$n\$: 0-7\)](#). (R/WTC/SS)

SLCHOST_SLC0_RX_UDF_INT_RAW The raw interrupt status of [SLCHOST_SLC0_RX_UDF_INT](#). (R/WTC/SS)

SLCHOST_SLC0_TX_OVF_INT_RAW The raw interrupt status of [SLCHOST_SLC0_TX_OVF_INT](#). (R/WTC/SS)

SLCHOST_SLC0_RX_NEW_PACKET_INT_RAW The raw interrupt status of [SLCHOST_SLC0_RX_NEW_PACKET_INT](#). (R/WTC/SS)

Register 33.42. SLCHOST_SLC1HOST_INT_RAW_REG (0x0054)

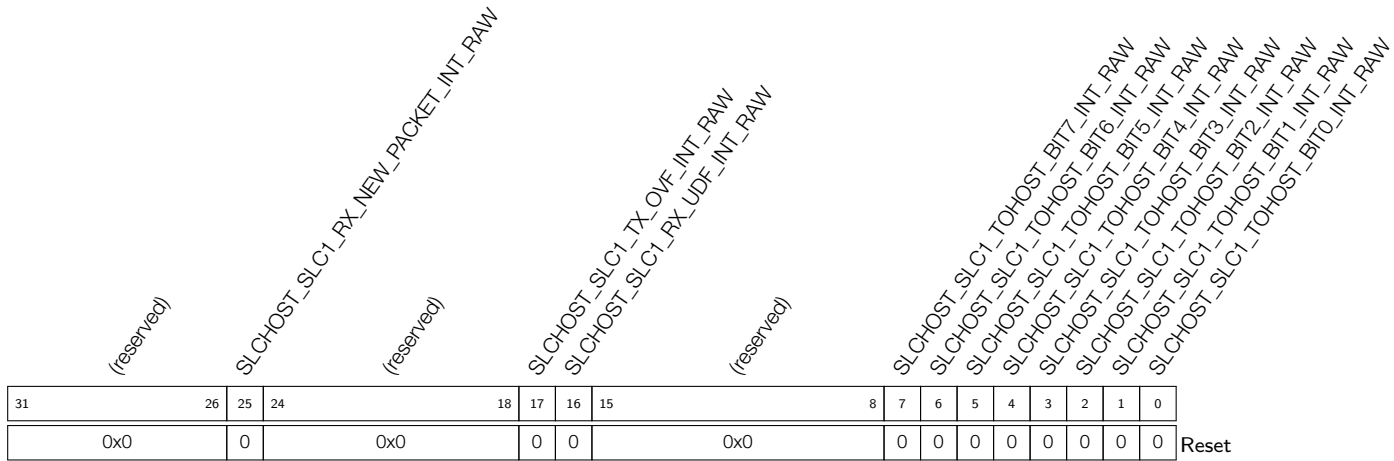

SLCHOST_SLC1_TOHOST_BIT n _INT_RAW (n : 0-7) The raw interrupt status of [SLCHOST_SLC1_TOHOST_BIT \$n\$ _INT \(\$n\$: 0-7\)](#). (R/WTC/SS)

SLCHOST_SLC1_RX_UDF_INT_RAW The raw interrupt status of [SLCHOST_SLC1_RX_UDF_INT](#). (R/WTC/SS)

SLCHOST_SLC1_TX_OVF_INT_RAW The raw interrupt status of [SLCHOST_SLC1_TX_OVF_INT](#). (R/WTC/SS)

SLCHOST_SLC1_RX_NEW_PACKET_INT_RAW The raw interrupt status of [SLCHOST_SLC1_RX_NEW_PACKET_INT](#). (R/WTC/SS)

Register 33.43. SLCHOST_SLC0HOST_INT_ST_REG (0x0058)

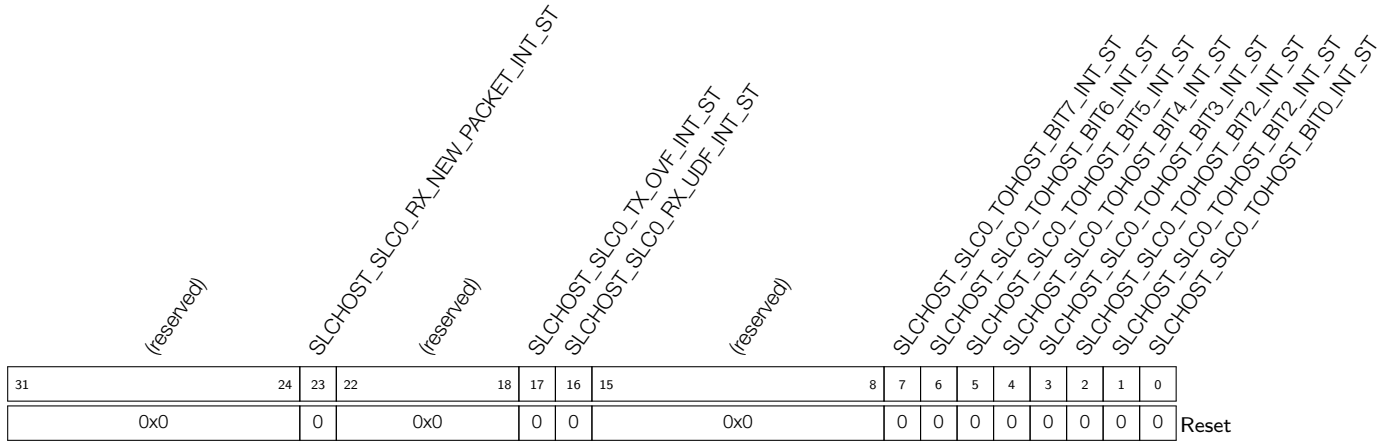

SLCHOST_SLC0_TOHOST_BIT n _INT_ST (n : 0-7) The masked interrupt status of [SLCHOST_SLC0_TOHOST_BIT \$n\$ _INT \(\$n\$: 0-7\)](#). (RO)

SLCHOST_SLC0_RX_UDF_INT_ST The masked interrupt status of [SLCHOST_SLC0_RX_UDF_INT](#). (RO)

SLCHOST_SLC0_TX_OVF_INT_ST The masked interrupt status of [SLCHOST_SLC0_TX_OVF_INT](#). (RO)

SLCHOST_SLC0_RX_NEW_PACKET_INT_ST The masked interrupt status of [SLCHOST_SLC0_RX_NEW_PACKET_INT](#). (RO)

Register 33.44. SLCHOST_SLC1HOST_INT_ST_REG (0x005C)

(reserved)				SLCHOST_SLC1_RX_NEW_PACKET_INT_ST				(reserved)				SLCHOST_SLC1_TX_OVF_INT_ST SLCHOST_SLC1_RX_UDF_INT_ST				(reserved)				SLCHOST_SLC1_TOHOST_BIT7_INT_ST SLCHOST_SLC1_TOHOST_BIT6_INT_ST SLCHOST_SLC1_TOHOST_BIT5_INT_ST SLCHOST_SLC1_TOHOST_BIT4_INT_ST SLCHOST_SLC1_TOHOST_BIT3_INT_ST SLCHOST_SLC1_TOHOST_BIT2_INT_ST SLCHOST_SLC1_TOHOST_BIT1_INT_ST SLCHOST_SLC1_TOHOST_BIT0_INT_ST							
31	26	25	24	18	17	16	15	8	7	6	5	4	3	2	1	0	Reset										
0x0				0				0x0				0 0				0x0				0 0 0 0 0 0 0 0							

SLCHOST_SLC1_TOHOST_BIT n _INT_ST (n : 0-7) The masked interrupt status of **SLCHOST_SLC1_TOHOST_BIT n _INT (n : 0-7)**. (RO)

SLCHOST_SLC1_RX_UDF_INT_ST The masked interrupt status of **SLCHOST_SLC1_RX_UDF_INT**. (RO)

SLCHOST_SLC1_TX_OVF_INT_ST The masked interrupt status of **SLCHOST_SLC1_TX_OVF_INT**. (RO)

SLCHOST_SLC1_RX_NEW_PACKET_INT_ST The masked interrupt status of **SLCHOST_SLC1_RX_NEW_PACKET_INT**. (RO)

Register 33.45. SLCHOST_CONF_W7_REG (0x008C)

SLCHOST_SLCHOST_CONF31				(reserved)				SLCHOST_SLCHOST_CONF29				(reserved)			
31	24	23	16	15	8	7	Reset								
0x0				0x0				0x0				0x0			

SLCHOST_SLCHOST_CONF29 The interrupt set bits of **SLCINT_SLC_FRHOST_BIT n _INT (n : 0-7)**. These bits will not be cleared automatically. (R/W)

SLCHOST_SLCHOST_CONF31 The interrupt set bits of **SLCINT_SLC_FRHOST_BIT n _INT (n : 8-15)**. These bits will not be cleared automatically. (R/W)

Register 33.46. SLCHOST_SLC0HOST_INT_CLR_REG (0x00D4)

(reserved)	SLCHOST_SLC0_RX_NEW_PACKET_INT_CLR	(reserved)	SLCHOST_SLC0_TX_OVF_INT_CLR	SLCHOST_SLC0_RX_UDF_INT_CLR	(reserved)	SLCHOST_SLC0_TOHOST_BIT7_INT_CLR	SLCHOST_SLC0_TOHOST_BIT6_INT_CLR	SLCHOST_SLC0_TOHOST_BIT5_INT_CLR	SLCHOST_SLC0_TOHOST_BIT4_INT_CLR	SLCHOST_SLC0_TOHOST_BIT3_INT_CLR	SLCHOST_SLC0_TOHOST_BIT2_INT_CLR	SLCHOST_SLC0_TOHOST_BIT1_INT_CLR	SLCHOST_SLC0_TOHOST_BIT0_INT_CLR			
31	24	23	22	18	17	16	15	8	7	6	5	4	3	2	1	0
0x0	0	0x0	0	0	0	0x0	0	0	0	0	0	0	0	0	0	0

Reset

SLCHOST_SLC0_TOHOST_BIT n _INT_CLR (n : 0-7) Write 1 to clear interrupt [SLCHOST_SLC0_TOHOST_BIT \$n\$ _INT \(\$n\$: 0-7\)](#). (WT)

SLCHOST_SLC0_RX_UDF_INT_CLR Write 1 to clear interrupt [SLCHOST_SLC0_RX_UDF_INT](#). (WT)

SLCHOST_SLC0_TX_OVF_INT_CLR Write 1 to clear interrupt [SLCHOST_SLC0_TX_OVF_INT](#). (WT)

SLCHOST_SLC0_RX_NEW_PACKET_INT_CLR Write 1 to clear interrupt [SLCHOST_SLC0_RX_NEW_PACKET_INT](#). (WT)

Register 33.47. SLCHOST_SLC1HOST_INT_CLR_REG (0x00D8)

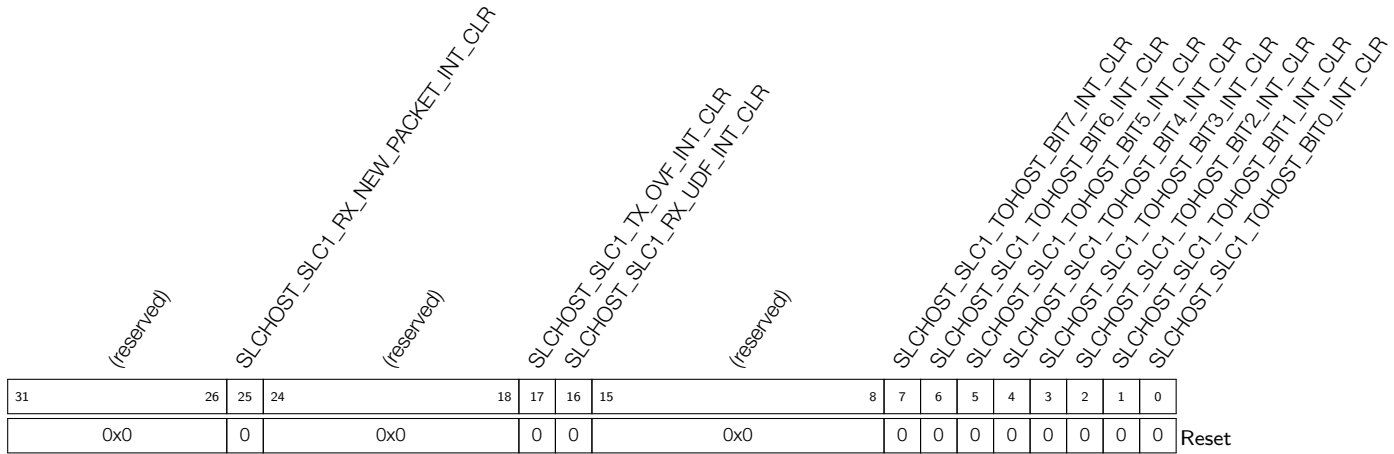

SLCHOST_SLC1_TOHOST_BIT n _INT_CLR (n : 0-7) Write 1 to clear interrupt [SLCHOST_SLC1_TOHOST_BIT \$n\$ _INT \(\$n\$: 0-7\)](#). (WT)

SLCHOST_SLC1_RX_UDF_INT_CLR Write 1 to clear interrupt [SLCHOST_SLC1_RX_UDF_INT](#). (WT)

SLCHOST_SLC1_TX_OVF_INT_CLR Write 1 to clear interrupt [SLCHOST_SLC1_TX_OVF_INT](#). (WT)

SLCHOST_SLC1_RX_NEW_PACKET_INT_CLR Write 1 to clear interrupt [SLCHOST_SLC1_RX_NEW_PACKET_INT](#). (WT)

Register 33.48. SLCHOST_SLC0HOST_FUNC1_INT_ENA_REG (0x00DC)

(reserved)	SLCHOST_FN1_SLC0_RX_NEW_PACKET_INT_ENA	(reserved)	SLCHOST_FN1_SLC0_TX_OVF_INT_ENA SLCHOST_FN1_SLC0_RX_UDF_INT_ENA	(reserved)	SLCHOST_FN1_SLC0_TOHOST_BIT7_INT_ENA SLCHOST_FN1_SLC0_TOHOST_BIT6_INT_ENA SLCHOST_FN1_SLC0_TOHOST_BIT5_INT_ENA SLCHOST_FN1_SLC0_TOHOST_BIT4_INT_ENA SLCHOST_FN1_SLC0_TOHOST_BIT3_INT_ENA SLCHOST_FN1_SLC0_TOHOST_BIT2_INT_ENA SLCHOST_FN1_SLC0_TOHOST_BIT1_INT_ENA SLCHOST_FN1_SLC0_TOHOST_BIT0_INT_ENA												
31	24	23	22	18	17	16	15	8	7	6	5	4	3	2	1	0	Reset
0x0		0	0x0		0	0	0x0		0	0	0	0	0	0	0	0	

SLCHOST_FN1_SLC0_TOHOST_BIT n _INT_ENA (n : 0-7) Write 1 to enable [SL-CHOST_SLC0_TOHOST_BIT \$n\$ _INT](#) (n : 0-7). (R/W)

SLCHOST_FN1_SLC0_RX_UDF_INT_ENA Write 1 to enable [SLCHOST_SLC0_RX_UDF_INT](#). (R/W)

SLCHOST_FN1_SLC0_TX_OVF_INT_ENA Write 1 to enable [SLCHOST_SLC0_TX_OVF_INT](#). (R/W)

SLCHOST_FN1_SLC0_RX_NEW_PACKET_INT_ENA Write 1 to enable [SL-CHOST_SLC0_RX_NEW_PACKET_INT](#). (R/W)

Register 33.49. SLCHOST_SLC1HOST_FUNC1_INT_ENA_REG (0x00E0)

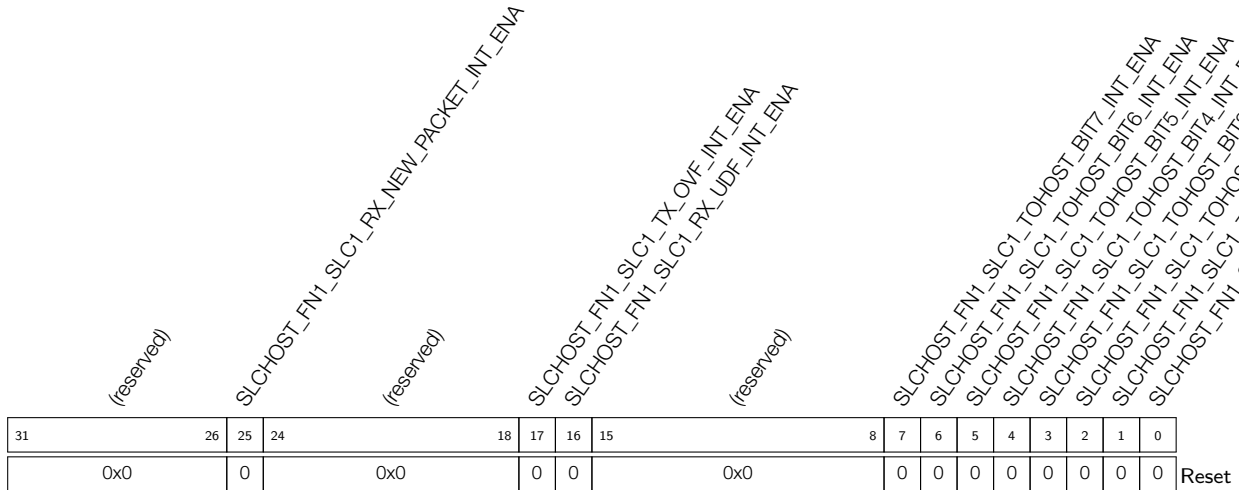

SLCHOST_FN1_SLC1_TOHOST_BIT n _INT_ENA (n : 0-7) Write 1 to enable **SLCHOST_SLC1_TOHOST_BIT n _INT** (n : 0-7). (R/W)

SLCHOST_FN1_SLC1_RX_UDF_INT_ENA Write 1 to enable **SLCHOST_SLC1_RX_UDF_INT**. (R/W)

SLCHOST_FN1_SLC1_TX_OVF_INT_ENA Write 1 to enable **SLCHOST_SLC1_TX_OVF_INT**. (R/W)

SLCHOST_FN1_SLC1_RX_NEW_PACKET_INT_ENA Write 1 to enable **SLCHOST_SLC1_RX_NEW_PACKET_INT**. (R/W)

Register 33.50. SLCHOST_SLC0HOST_TOKEN_RDATA_REG (0x0044)

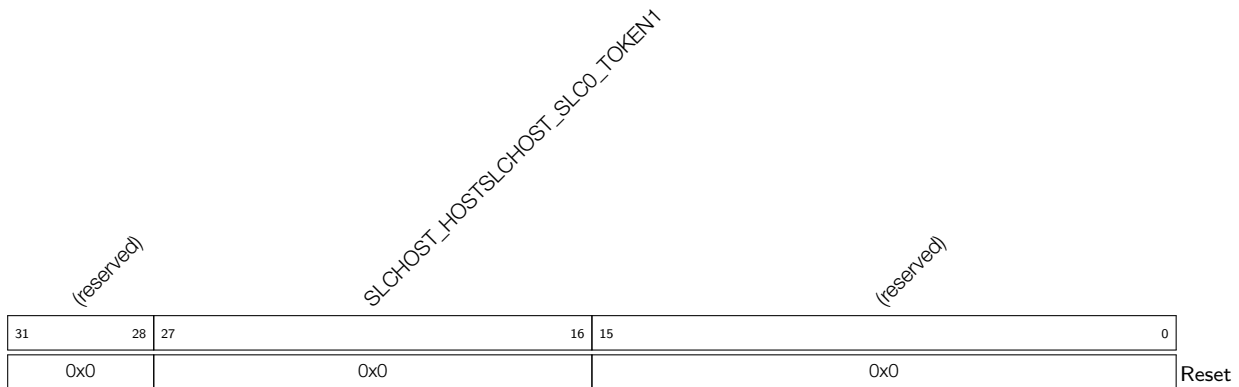

SLCHOST_HOSTSLCHOST_SLC0_TOKEN1 Represents the SLC0 accumulated number of buffers for receiving data. (RO)

Register 33.51. SLCHOST_PKT_LEN_REG (0x0060)

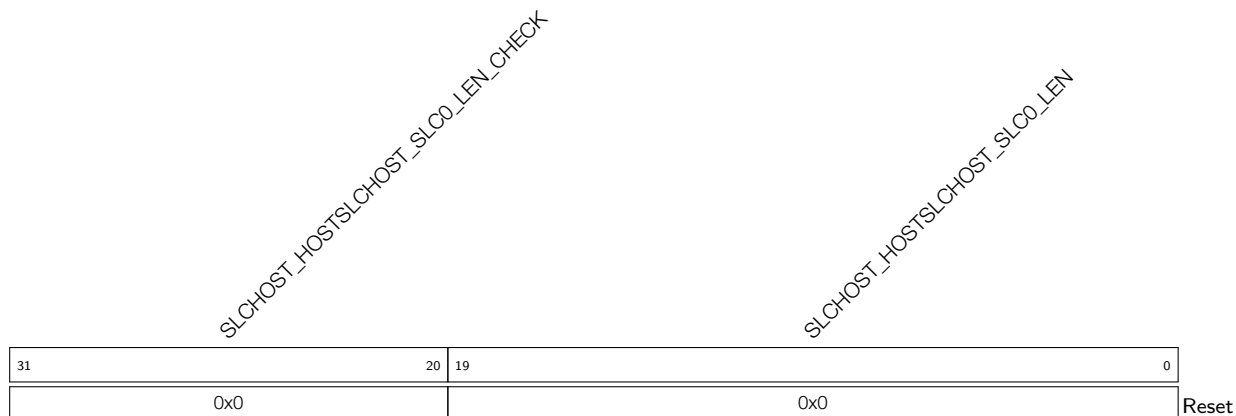

SLCHOST_HOSTSLCHOST_SLC0_LEN Represents the accumulated length of data that the slave wants to send. The value gets updated only when the host reads it. (RO)

SLCHOST_HOSTSLCHOST_SLC0_LEN_CHECK Check SLCHOST_HOSTSLCHOST_SLC0_LEN. Its value is SLCHOST_HOSTSLCHOST_SLC0_LEN bit[9:0] plus bit[19:10]. (RO)

Register 33.52. SLCHOST_SLC1HOST_TOKEN_RDATA_REG (0x00C4)

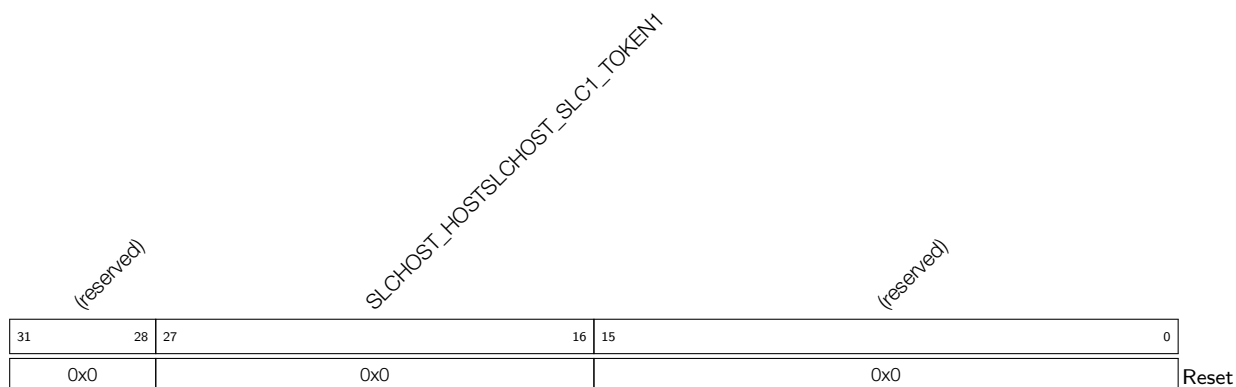

SLCHOST_HOSTSLCHOST_SLC1_TOKEN1 Represents the SLC1 accumulated number of buffers for receiving data. (RO)

Register 33.53. SLCHOST_CONF_Wn_REG(n: 0-2) (0x006C+0x4*n)

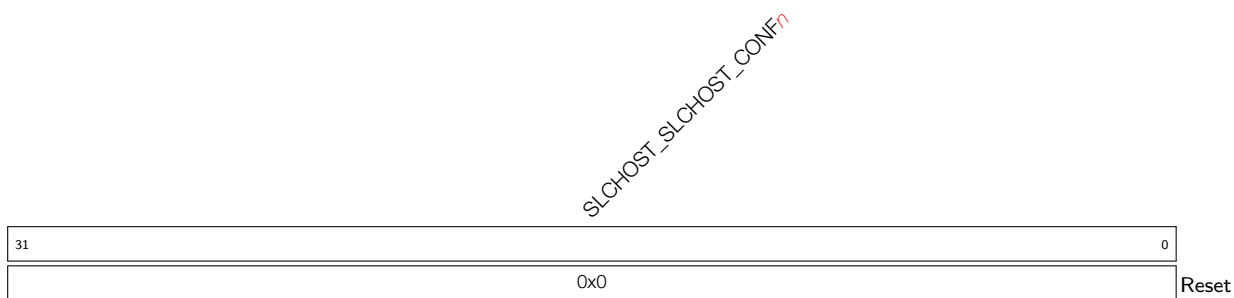

SLCHOST_SLCHOST_CONFⁿ The information interaction register between the host and slave. Both of them can access it. (R/W)

Register 33.54. SLCHOST_CONF_W3_REG (0x0078)

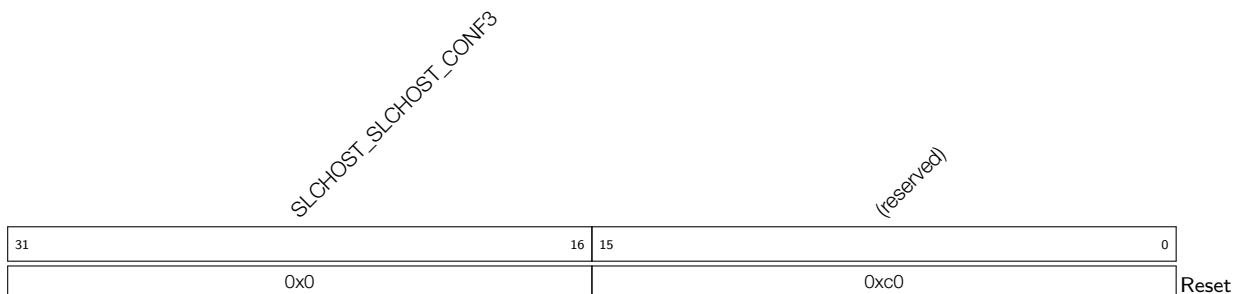

SLCHOST_SLCHOST_CONF³ The information interaction register between the host and slave. Both of them can access it. (R/W)

Register 33.55. SLCHOST_CONF_W4_REG (0x007C)

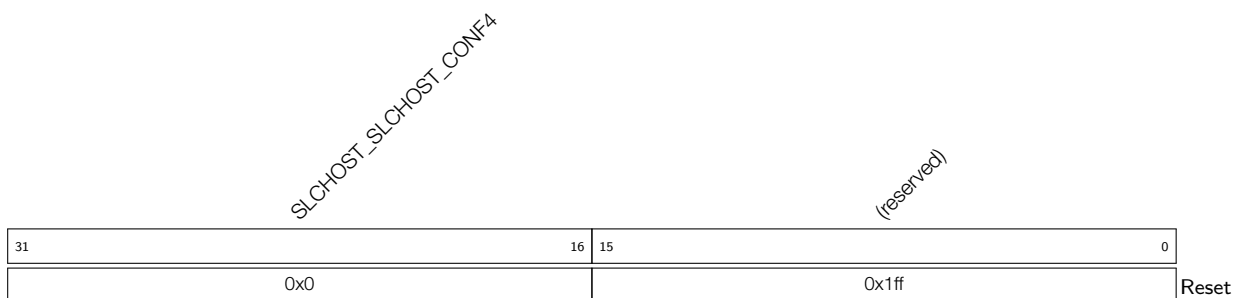

SLCHOST_SLCHOST_CONF⁴ The information interaction register between the host and slave. Both of them can access it. (R/W)

Register 33.56. SLCHOST_CONF_W6_REG (0x0088)

SLCHOST_SLCHOST_CONF6 The information interaction register between the host and slave. Both of them can access it. (R/W)

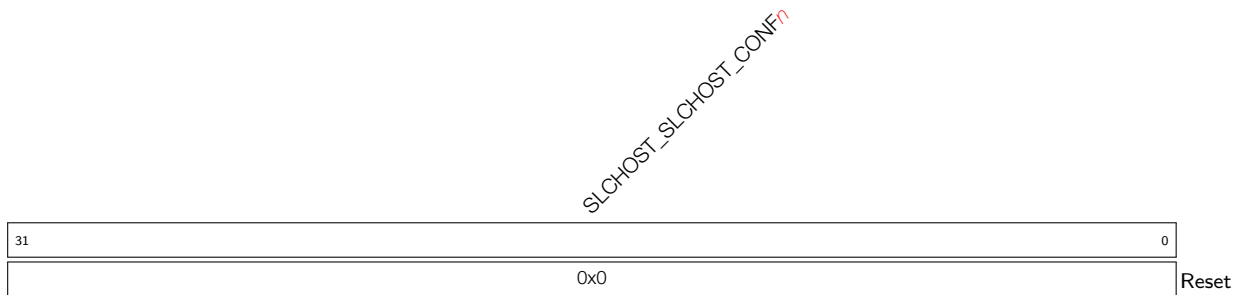
Register 33.57. SLCHOST_CONF_W n _REG(n : 8-15) (0x009C+0x4*(n -8))

SLCHOST_SLCHOST_CONF n The information interaction register between the host and slave. Both of them can access it. (R/W)

34 LED PWM Controller (LEDC)

34.1 Overview

The LED PWM Controller is a peripheral designed to generate PWM signals for LED control. It has specialized features such as automatic duty cycle fading. However, the LED PWM Controller can also be used to generate PWM signals for other purposes.

34.2 Features

The LED PWM Controller has the following features:

- Six independent PWM generators (i.e. six channels)
- Maximum PWM duty cycle resolution: 20 bits
- Four independent timers that support fractional division
- Adjustable phase of PWM signal output
- PWM duty cycle dithering
- Automatic duty cycle fading — gradual increase/decrease of a PWM's duty cycle without interference from the processor. An interrupt will be generated upon fade completion
- Up to 16 duty cycle ranges for each PWM generator to generate gamma curve signals - each range can be independently configured in terms of fading direction (increase or decrease), fading amount (the amount by which the duty cycle increases or decreases each time), the number of fades (how many times the duty cycle fades in one range), and fading frequency
- PWM signal output in low-power mode (Light-sleep mode)
- Event generation and task response related to the Event Task Matrix (ETM) peripheral

Note that the four timers are identical regarding their features and operation. The following sections refer to the timers collectively as Timer x (where x ranges from 0 to 3). Likewise, the six PWM generators are also identical in features and operation, and thus are collectively referred to as PWM n (where n ranges from 0 to 5).

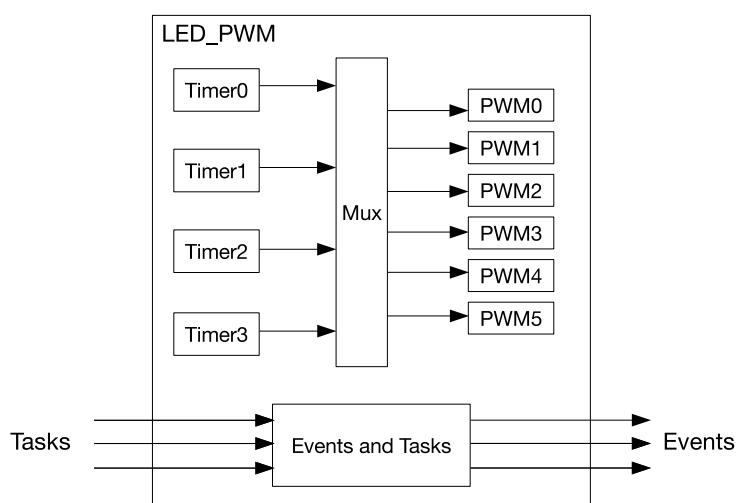

Figure 34-1. LED PWM Architecture

PRELIMINARY

34.3 Functional Description

34.3.1 Architecture

Figure 34-1 shows the architecture of the LED PWM Controller.

Each of the four timers has an internal timebase counter (i.e. a counter that counts on cycles of a reference clock) and thus can be independently configured (i.e. configurable clock divider, and counter overflow value). Each PWM generator selects one of the timers by configuring the `LEDC_TIMER_SEL_CHn`, and uses the timer's counter value `timerx_cnt` as a reference to generate its PWM signal.

Figure 34-2 illustrates the main functional blocks of the timer and the PWM generator.

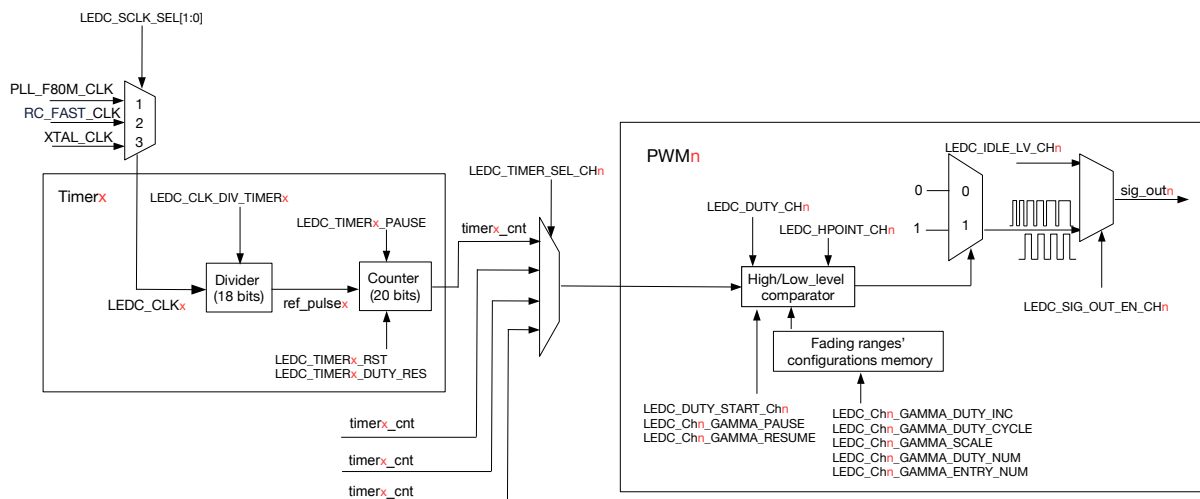

Figure 34-2. Timer and PWM Generator Block Diagram

34.3.2 Timers

Each timer in LED PWM Controller internally maintains a timebase counter. Referring to Figure 34-2, this clock signal used by the timebase counter is named `ref_pulsex`. All timers use the same clock source `LEDC_CLKx`, which is then passed through a clock divider to generate `ref_pulsex` for the counter.

34.3.2.1 Clock Source

LED PWM registers configured by software are clocked by `APB_CLK`. To use the LED PWM peripheral, the `APB_CLK` signal going to the LED PWM has to be enabled. The `APB_CLK` signal to LED PWM can be enabled by setting the `PCR_LEDC_CLK_EN` field in the `PCR_LEDC_CONF_REG` register, and reset via software by setting the `PCR_LEDC_RST_EN` field in the `PCR_LEDC_CONF_REG` register.

Timers in the LED PWM Controller choose their common clock source from one of the following clock signals: `PLL_F80M_CLK`, `RC_FAST_CLK`, and `XTAL_CLK`. The procedure for selecting a clock source signal for `LEDC_CLKx` is described below:

- `PLL_F80M_CLK`: Set `LEDC_SCLK_SEL[1:0]` to 1
- `RC_FAST_CLK`: Set `LEDC_SCLK_SEL[1:0]` to 2
- `XTAL_CLK`: Set `LEDC_SCLK_SEL[1:0]` to 3

The LEDC_CLK x signal will then be passed through the clock divider.

For more information, please refer to Chapter 8 *Reset and Clock*.

34.3.2.2 Clock Divider Configuration

The LEDC_CLK x signal is passed through a clock divider to generate the ref_pulse x signal for the counter. The frequency of ref_pulse x is equal to the frequency of LEDC_CLK x divided by the divisor LEDC_CLK_DIV (see Figure 34-2).

The clock divider is a fractional divider. Thus, the divisor LEDC_CLK_DIV can be non-integer values. LEDC_CLK_DIV is configured according to the following equation.

$$\text{LEDC_CLK_DIV} = A + \frac{B}{256}$$

- The integer part A corresponds to the most significant 10 bits of LEDC_CLK_DIV_TIMER x (i.e. LEDC_TIMER x _CONF_REG[22:13])
- The fractional part B corresponds to the least significant 8 bits of LEDC_CLK_DIV_TIMER x (i.e. LEDC_TIMER x _CONF_REG[12:5])

When the fractional part B is 0, LEDC_CLK_DIV is equivalent to an integer divisor (i.e. an integer prescaler). In other words, a ref_pulse x clock pulse is generated after every A number of LEDC_CLK x clock pulses.

However, when B is not 0, LEDC_CLK_DIV becomes a non-integer divisor. The clock divider implements non-integer frequency division by alternating between A and $(A+1)$ LEDC_CLK x clock pulses per ref_pulse x clock pulse. In this way, the average frequency of ref_pulse x clock pulse will be the desired frequency (i.e. the non-integer divided frequency). For every 256 ref_pulse x clock pulses:

- A number of B ref_pulse x clock pulses are generated every $(A+1)$ LEDC_CLK x clock pulses
- A number of $(256-B)$ ref_pulse x clock pulses are generated every A LEDC_CLK x clock pulses
- The ref_pulse x clock pulses generated every $(A+1)$ pulses are evenly distributed amongst those generated every A pulses

Figure 34-3 illustrates the relation between LEDC_CLK x clock pulses and ref_pulse x clock pulses when LEDC_CLK_DIV is a non-integer value.

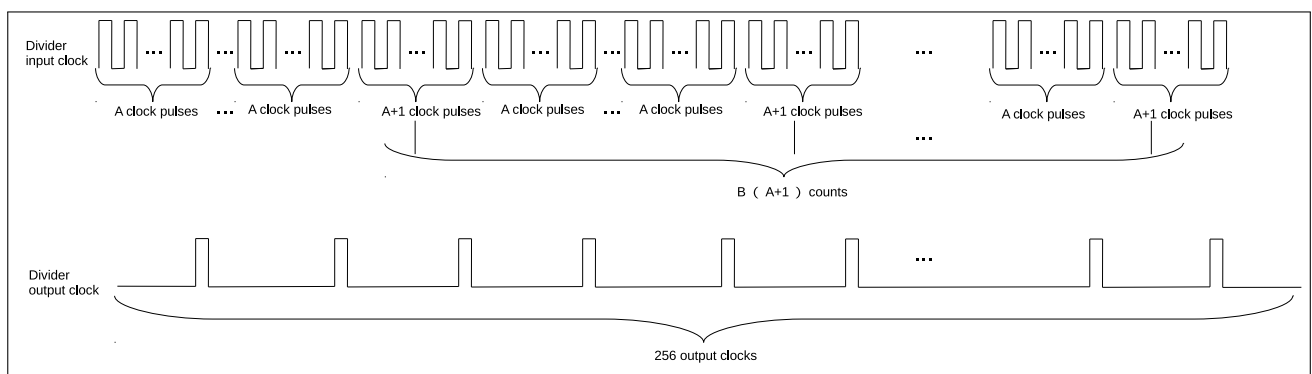

Figure 34-3. Frequency Division When LEDC_CLK_DIV is a Non-Integer Value

To change the timer's clock divisor at runtime, first configure the LEDC_CLK_DIV_TIMER x field, and then set the LEDC_TIMER x _PARA_UP field to apply the new configuration. This will cause the newly configured values to

take effect upon the next overflow of the counter. The `LEDC_TIMERx_PARA_UP` field will be automatically cleared by hardware.

34.3.2.3 20-Bit Counter

Each timer contains a 20-bit timebase counter that uses `ref_pulsex` as its reference clock (see Figure 34-2). The `LEDC_TIMERx_DUTY_RES` field configures the overflow value of this 20-bit counter. Hence, the maximum resolution of the PWM signal is 20 bits. The counter counts up to $2^{\text{LEDC_TIMERx_DUTY_RES}} - 1$, overflows and begins counting from 0 again. The counter's value can be read, reset, and suspended by software. Figure 34-4 shows the relationship between the counter and PWM resolution.

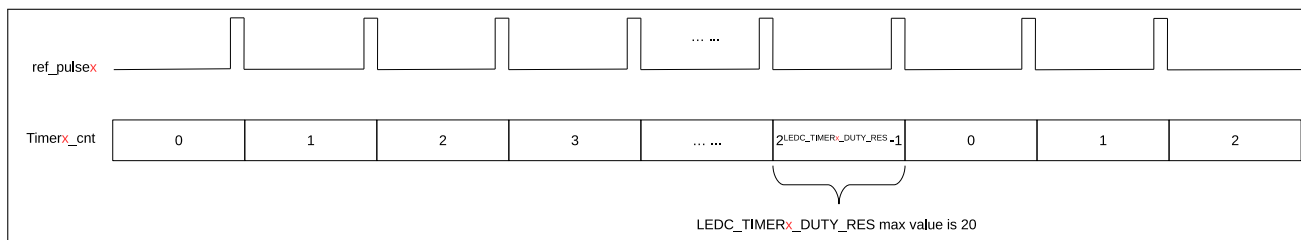

Figure 34-4. Relationship Between Counter And Resolution

Every time the counter overflows, it can trigger the `LEDC_TIMERx_OVF_INT` interrupt (generated automatically by hardware without configuration). It can also be configured to trigger `LEDC_OVF_CNT_CHn_INT` interrupt after overflowing `LEDC_OVF_NUM_CHn + 1` times. To configure `LEDC_OVF_CNT_CHn_INT` interrupt, please:

1. Configure `LEDC_TIMER_SEL_CHn` to select the timer for the PWM generator
2. Enable the overflow counter by setting `LEDC_OVF_CNT_EN_CHn`
3. Configure `LEDC_OVF_NUM_CHn` with the number of counter overflows (that triggers an interrupt) minus 1
4. Enable the overflow interrupt by setting `LEDC_OVF_CNT_CHn_INT_ENA`
5. Set `LEDC_TIMERx_DUTY_RES` to enable the timer and wait for a `LEDC_OVF_CNT_CHn_INT` interrupt

To change the overflow value at runtime, first set the `LEDC_TIMERx_DUTY_RES` field, and then set the `LEDC_TIMERx_PARA_UP` field. This will cause the newly configured values to take effect upon the next overflow of the counter. If `LEDC_OVF_CNT_EN_CHn` field is reconfigured, `LEDC_PARA_UP_CHn` should be set to apply the new configuration. In summary, these configuration values need to be updated by setting `LEDC_TIMERx_PARA_UP` or `LEDC_PARA_UP_CHn`. `LEDC_TIMERx_PARA_UP` and `LEDC_PARA_UP_CHn` will be automatically cleared by hardware.

Referring to Figure 34-2, the frequency of a PWM generator output signal (`sig_outn`) is dependent on the frequency of the timer's clock source `LEDC_CLKx`, the clock divisor `LEDC_CLK_DIV`, and the duty resolution (counter width) `LEDC_TIMERx_DUTY_RES`:

$$f_{\text{PWM}} = \frac{f_{\text{LEDC_CLK}_x}}{\text{LEDC_CLK_DIV} \cdot 2^{\text{LEDC_TIMER}_x\text{_DUTY_RES}}}$$

Based on the formula above, the desired duty resolution can be calculated as follows:

$$\text{LEDC_TIMER}_x\text{_DUTY_RES} = \log_2 \left(\frac{f_{\text{LEDC_CLK}_x}}{f_{\text{PWM}} \cdot \text{LEDC_CLK_DIV}} \right)$$

Table 34-1 lists the commonly-used frequencies and their corresponding resolutions.

Table 34-1. Commonly-used Frequencies and Resolutions

LEDC_CLK _x	PWM Frequency	Highest Resolution (bit) ¹	Lowest Resolution (bit) ²
PLL_F80M_CLK (80 MHz)	1 kHz	16	6
PLL_F80M_CLK (80 MHz)	5 kHz	13	3
PLL_F80M_CLK (80 MHz)	10 kHz	12	2
XTAL_CLK (40 MHz)	1 kHz	15	5
XTAL_CLK (40 MHz)	4 kHz	13	3
RC_FAST_CLK (20 MHz)	1 kHz	14	4
RC_FAST_CLK (20 MHz)	2 kHz	13	3

¹ The highest resolution is calculated when the clock divisor LEDC_CLK_DIV is 1. If the highest resolution calculated by the formula is higher than the counter's width 20 bits, then the highest resolution should be 20 bits.

² The lowest resolution is calculated when the clock divisor LEDC_CLK_DIV is $1023 + \frac{255}{256}$. If the lowest resolution calculated by the formula is lower than 0, then the lowest resolution should be 1.

34.3.3 PWM Generators

To generate a PWM signal, a PWM generator (PWM_n) needs a timer (Timer_x). Each PWM generator can be configured separately by setting LEDC_TIMER_SEL_CH_n to use one of four timers to generate the PWM output.

As shown in Figure 34-2, each PWM generator has a comparator and two multiplexers. A PWM generator compares the timer's 20-bit counter value (Timer_x_cnt) to two trigger values Hpoint_n and Lpoint_n. When the timer's counter value is equal to Hpoint_n or Lpoint_n, the PWM signal is high or low, respectively, as described below:

- If Timer_x_cnt == Hpoint_n, sig_out_n is 1.
- If Timer_x_cnt == Lpoint_n, sig_out_n is 0.

Figure 34-5 illustrates how Hpoint_n and Lpoint_n are used to generate a fixed duty cycle PWM output signal.

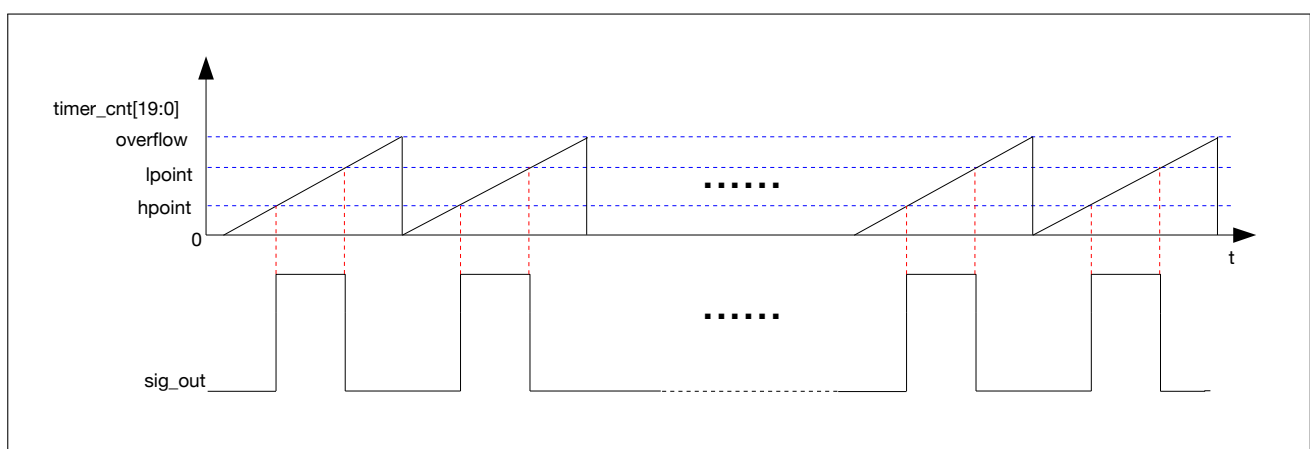

Figure 34-5. LED PWM Output Signal Diagram

For a particular PWM generator (PWM n), its Hpoint n is sampled from the `LEDC_HPOINT_CH n` field each time the selected timer's counter overflows. Likewise, Lpoint n is also sampled on every counter overflow and is calculated from the sum of the `LEDC_DUTY_CH n [24:4]` and `LEDC_HPOINT_CH n` fields. By setting Hpoint n and Lpoint n via the `LEDC_HPOINT_CH n` and `LEDC_DUTY_CH n [24:4]` fields, the relative phase and duty cycle of the PWM output can be set.

The PWM output signal (sig_out n) is enabled by setting `LEDC_SIG_OUT_EN_CH n` . When `LEDC_SIG_OUT_EN_CH n` is cleared, PWM signal output is disabled, and the output signal (sig_out n) will output a constant level specified by `LEDC_IDLE_LV_CH n` .

The bits `LEDC_DUTY_CH n [3:0]` are used to dither the duty cycles of the PWM output signal (sig_out n) by periodically altering the duty cycle of sig_out n . When `LEDC_DUTY_CH n [3:0]` is not 0, then for every 16 cycles of sig_out n , `LEDC_DUTY_CH n [3:0]` of those cycles will have PWM pulses that are one timer tick longer than the other (16- `LEDC_DUTY_CH n [3:0]`) cycles. For instance, if `LEDC_DUTY_CH n [24:4]` is set to 10 and `LEDC_DUTY_CH n [3:0]` is set to 5, then 5 of 16 cycles will have a PWM pulse with a duty value of 11 and the rest of the 16 cycles will have a PWM pulse with a duty value of 10. The average duty cycle after 16 cycles is 10.3125.

If fields `LEDC_TIMER_SEL_CH n` , `LEDC_HPOINT_CH n` , `LEDC_DUTY_CH n [24:4]`, and `LEDC_SIG_OUT_EN_CH n` are reconfigured, `LEDC_PARA_UP_CH n` must be set to apply the new configuration. This will cause the newly configured values to take effect upon the next overflow of the counter. `LEDC_PARA_UP_CH n` field will be automatically cleared by hardware.

34.3.4 Duty Cycle Fading

The PWM generators can fade the duty cycle of a PWM output signal (i.e. gradually change the duty cycle from one value to another). Each PWM generator can have up to 16 duty cycle ranges, which can be independently configured in terms of fading direction (increase or decrease), fading amount, the number of fades, and fading frequency. If Duty Cycle Fading is enabled, every range's Lpoint n value will change according to its fading configuration.

34.3.4.1 Linear Duty Cycle Fading

Linear fading PWM signals can be generated by configuring the direction, fading amount, the number of fades, and fading frequency of the first duty cycle range.

Below are the programming procedures:

1. Configure the `LEDC_DUTY_CH n` field with the initial value of Lpoint n .
2. Set the `LEDC_DUTY_START_CH n` field to enable Duty Cycle Fading. When this field is cleared, Duty Cycle Fading will be disabled.
3. Configure the direction via the `LEDC_CH n _GAMMA_DUTY_INC` field of the `LEDC_CH n _GAMMA_WR_REG` register. When this field is set or cleared, the Lpoint n will increment or decrement in the current configured range.
4. Configure the number of times the counter overflows per an increase or decrease of Lpoint n via the `LEDC_CH n _GAMMA_DUTY_CYCLE` field of the `LEDC_CH n _GAMMA_WR_REG` register. In other words, Lpoint n will increase or decrease after the counter overflows for `LEDC_CH n _GAMMA_DUTY_CYCLE` times.

5. Configure the amount by which L_{pointn} increase or decrease in the configured range via the `LEDC_CH n _GAMMA_SCALE` field of the `LEDC_CH n _GAMMA_WR_REG` register.
6. Configure the number of fades via the `LEDC_CH n _GAMMA_DUTY_NUM` field of the `LEDC_CH n _GAMMA_WR_REG` register.
7. Write the duty cycle range number (0 in this case) to the `LEDC_CH n _GAMMA_WR_ADDR` field of the `LEDC_CH n _GAMMA_WR_ADDR_REG` register. This range number (from 0 to 15) specifies to which range the configurations in Step 3, 4, 5, and 6 apply. For linear duty cycle fading only the first range needs to be configured, so configure `LEDC_CH n _GAMMA_WR_ADDR` as 0.
8. Configure the number of ranges per each fading (1 in this case) via the `LEDC_CH n _GAMMA_ENTRY_NUM` field of the `LEDC_CH n _GAMMA_CONF_REG`. Once the specified number of ranges have been faded, Duty Cycle Fading stops and the PWM generator triggers the `LEDC_DUTY_CHNG_END_CH n _INT` interrupt. For linear duty cycle fading there is only one duty cycle range (i.e. the first one), so configure `LEDC_CH n _GAMMA_ENTRY_NUM` as 1.
9. Set the `LEDC_PARA_UP_CH n` field to apply the above configurations. After this field is set, the configurations for Duty Cycle Fading will take effect upon the next overflow of the counter, and the PWM generator will output a linear fading PWM signal following configurations. `LEDC_PARA_UP_CH n` field will be automatically cleared by hardware.

After the above procedures, the PWM generator can fade the duty cycle of a PWM signal once per `LEDC_CH n _GAMMA_DUTY_CYCLE` times of counter overflows. Every time when the PWM signal is faded, L_{pointn} increases or decreases (configured by `LEDC_CH n _GAMMA_DUTY_INC`) by `LEDC_CH n _GAMMA_SCALE`, and the duty cycle increases or decreases (configured by `LEDC_CH n _GAMMA_DUTY_INC`) by

$$\frac{LEDC_CHn_GAMMA_SCALE}{LEDC_TIMERx_DUTY_RES}$$

The duty cycle is faded for `LEDC_CH n _GAMMA_DUTY_NUM` times. After that, the PWM generator stops fading and keeps outputting signals at this duty cycle. Upon each fading the duty cycle increases or decreases by the same amount, and therefore the PWM signal is a linear fading signal.

Figure 34-6 shows a linear fading PWM signal.

34.3.4.2 Gamma Curve Fading

Gamma curve fading PWM signals can be generated by configuring the fading direction, fading amount, the number of fades and fading frequency of multiple duty cycle fading ranges.

Below are the programming procedures:

1. The same as Step 1 in Section 34.3.4.1.
2. The same as Step 2 in Section 34.3.4.1.
3. Configure multiple duty cycle ranges:
 - (a) Configure the `LEDC_CH n _GAMMA_DUTY_INC` field of the `LEDC_CH n _GAMMA_WR_REG` register for the currently configured range.
 - (b) Configure the `LEDC_CH n _GAMMA_DUTY_CYCLE` field of the `LEDC_CH n _GAMMA_WR_REG` register for the currently configured range.

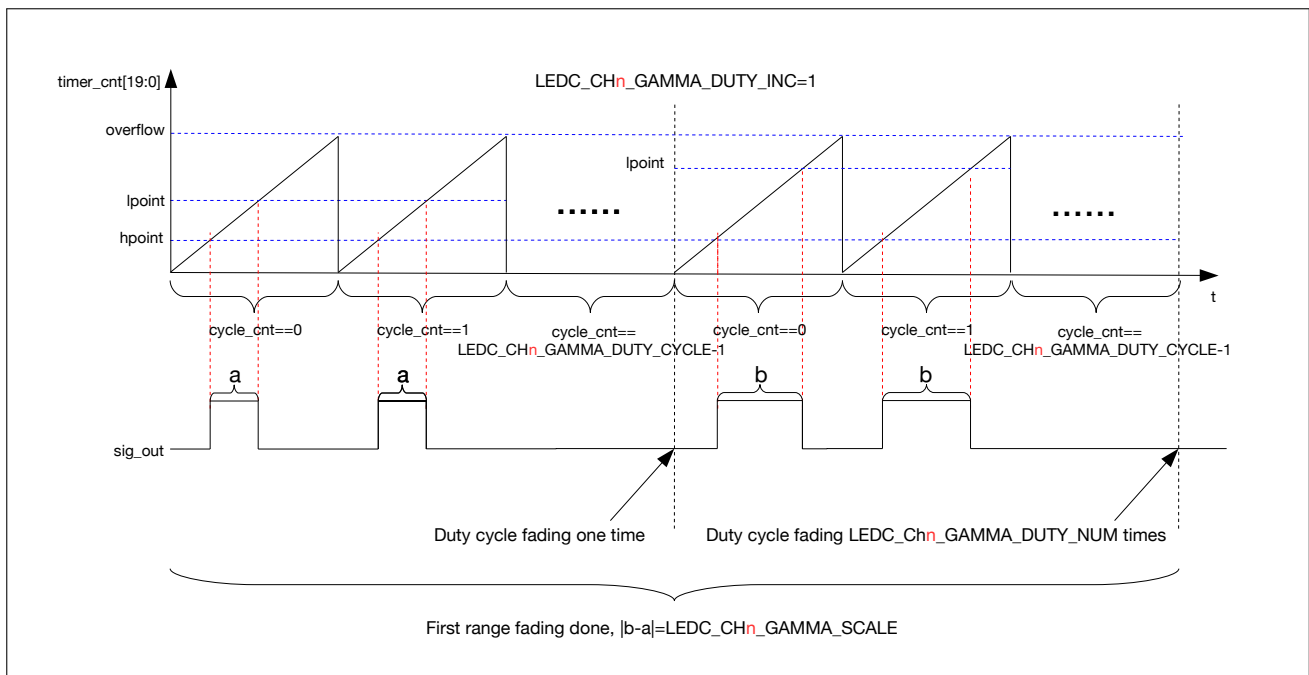

Figure 34-6. Output Signal of Linear Duty Cycle Fading

- (c) Configure the `LEDC_Chn_GAMMA_SCALE` field of the `LEDC_Chn_GAMMA_WR_REG` register for the currently configured range.
 - (d) Configure the `LEDC_Chn_GAMMA_DUTY_NUM` field of the `LEDC_Chn_GAMMA_WR_REG` register for the currently configured range.
 - (e) Write the duty cycle range number (from 0 to 15) to the `LEDC_Chn_GAMMA_WR_ADDR` field of the `LEDC_Chn_GAMMA_WR_ADDR_REG` register. This range number specifies to which range the above configurations apply. It must start from 0 and increase by 1 for the next range to be configured.
 - (f) Once the above procedures are finished, the configuration for one range is complete. Other ranges are configured by repeating the same set of procedures. You can configure any number of ranges from 0 to 16, and each can be configured independently.
4. After all required ranges are configured, write the total number of ranges configured in Step 3 to the `LEDC_Chn_GAMMA_ENTRY_NUM` field of the `LEDC_Chn_GAMMA_CONF_REG` register.
 5. Set the `LEDC_PARA_UP_Chn` field to apply the above configuration. After this field is set, the configurations for duty cycle fading will take effect upon the next overflow of the counter, and the PWM generator will output a gamma curve fading PWM signal following the configurations. `LEDC_PARA_UP_Chn` field will be automatically cleared by hardware.

After the above procedures, the PWM generator can generate a PWM signal with `LEDC_Chn_GAMMA_ENTRY_NUM` ranges. The duty cycle of the PWM signal fades according to the configurations of range 0 first, and then range 1, till range (`LEDC_Chn_GAMMA_ENTRY_NUM - 1`) (the last range) where Duty Cycle Fading ends. The PWM signal fades independently in each range. In range `LEDC_Chn_GAMMA_WR_ADDR`, every time when the counter overflows for `LEDC_Chn_GAMMA_DUTY_CYCLE` times, `Lpointn` increases or decreases (configured by `LEDC_Chn_GAMMA_DUTY_INC`) by `LEDC_Chn_GAMMA_SCALE`, and accordingly the duty cycle increases or decreases (configured by `LEDC_Chn_GAMMA_DUTY_INC`) by

$$\frac{\text{LEDC_CH}_n\text{_GAMMA_SCALE}}{\text{LEDC_TIMER}_x\text{_DUTY_RES}}$$

After the duty cycle fades for `LEDC_CHn_GAMMA_DUTY_NUM` times in a range, Duty Cycle Fading in this range finishes.

When Duty Cycle Fading finishes in all ranges (the number of ranges is specified by `LEDC_CHn_GAMMA_ENTRY_NUM`), the PWM signal stops fading and keeps the duty cycle of the last fade.

Given that the duty cycle fades differently and linearly in each range, several linear fading ranges would be fitted to a gamma curve.

Figure 34-7 illustrates a gamma curve fading PWM signal.

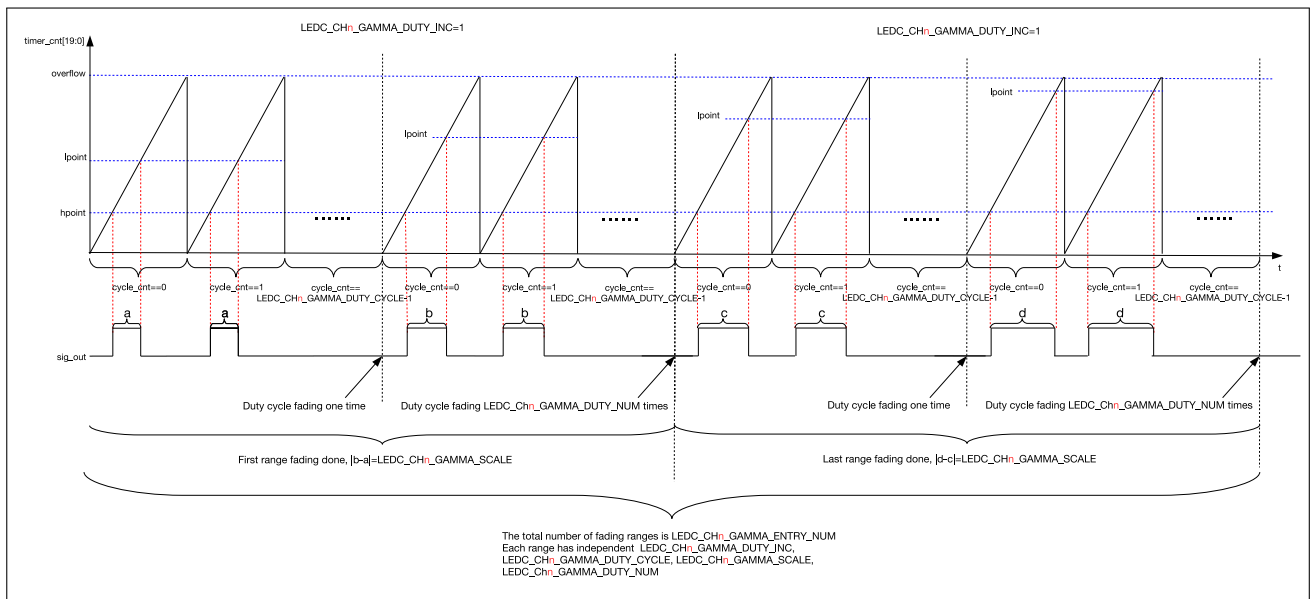

Figure 34-7. Output Signal of Gamma Curve Fading

34.3.4.3 Suspend and Resume Duty Cycle Fading

To suspend Duty Cycle Fading that has already been started, write 1 to the `LEDC_CHn_GAMMA_PAUSE` field of the `LEDC_CHn_GAMMA_CONF_REG` register. Once `LEDC_CHn_GAMMA_PAUSE` is set to 1, the PWM signal keeps the duty cycle of the most recent fade.

To resume Duty Cycle Fading, write 1 to the `LEDC_CHn_GAMMA_RESUME` field of the `LEDC_CHn_GAMMA_CONF_REG` register. Once `LEDC_CHn_GAMMA_RESUME` is set to 1, the PWM signal resumes fading from the range where the suspension occurs, until fading in the last range finishes. The fading will continue from the state when it was paused until all the ranges complete duty cycle fading (when `LEDC_CHn_GAMMA_RESUME` is set to 1, `LEDC_CHn_GAMMA_PAUSE` is cleared automatically by hardware).

34.3.5 Event Task Matrix Feature

The LEDC on ESP32-C6 supports the Event Task Matrix (ETM) function, which allows LEDC's ETM tasks to be triggered by any peripherals' ETM events, or LEDC's ETM events to trigger any peripherals' ETM tasks. This section introduces the ETM tasks and events related to LEDC. For more information, please refer to Chapter 11 [Event Task Matrix \(SOC_ETM\)](#).

ETM-related events and tasks are enabled by configuring corresponding fields of [LEDC_EVT_TASK_EN0_REG](#), [LEDC_EVT_TASK_EN1_REG](#) and [LEDC_EVT_TASK_EN2_REG](#) registers. For the correspondence between events, tasks, and fields, Please refer to Section 34.5).

LEDC can receive the following ETM tasks:

- [LEDC_TASK_DUTY_SCALE_UPDATE_CHn](#): If the [LEDC_TASK_DUTY_SCALE_UPDATE_CHn_EN](#) field is enabled, upon receiving the [LEDC_TASK_DUTY_SCALE_UPDATE_CHn](#) task, PWM n generates fading PWM signals according to the newly configured [LEDC_CHn_GAMMA_SCALE](#) field.
- [LEDC_TASK_TIMERx_RES_UPDATE](#): If the [LEDC_TASK_TIMERx_RES_UPDATE_EN](#) field is enabled, upon receiving the [LEDC_TASK_TIMERx_RES_UPDATE](#) task, Timer x updates its counter's overflow value to the value configured in the [LEDC_TIMERx_DUTY_RES](#) field at the next overflow of the counter.
- [LEDC_TASK_TIMERx_CAP](#): If the [LEDC_TASK_TIMERx_CAP_EN](#) field is enabled, upon receiving the [LEDC_TASK_TIMERx_CAP](#) task, Timer x captures its counter's value, and stores the value into the [LEDC_TIMERx_CNT_CAP](#) field of register [LEDC_TIMERx_CNT_CAP_REG](#).
- [LEDC_TASK_SIG_OUT_DIS_CHn](#): If the [LEDC_TASK_SIG_OUT_DIS_CHn_EN](#) field is enabled, upon receiving the [LEDC_TASK_SIG_OUT_DIS_CHn](#) task, PWM n 's signal output is disabled, and the output signal (sig_out n) outputs a constant level as specified by field [LEDC_IDLE_LV_CHn](#), as shown in Figure 34-2.
- [LEDC_TASK_OVF_CNT_RST_CHn](#): If the [LEDC_TASK_OVF_CNT_RST_CHn_EN](#) field is enabled, upon receiving the [LEDC_TASK_OVF_CNT_RST_CHn](#) task, PWM n timer's overflow counter is reset to 0.
- [LEDC_TASK_TIMERx_RST](#): If the [LEDC_TASK_TIMERx_RST_EN](#) field is enabled, upon receiving the [LEDC_TASK_TIMERx_RST](#) task, Timer x 's counter is reset to 0.
- [LEDC_TASK_TIMERx_RESUME](#) and [LEDC_TASK_TIMERx_PAUSE](#): If the [LEDC_TASK_TIMERx_PAUSE_RESUME_EN](#) field is enabled, upon receiving the [LEDC_TASK_TIMERx_RESUME](#) and [LEDC_TASK_TIMERx_PAUSE](#) task, Timer x is suspended and resumed alternately. That is, when the task is received, Timer x is paused; and when the task is received again, Timer x is resumed.
- [LEDC_TASK_GAMMA_RESTART_CHn](#): If the [LEDC_TASK_GAMMA_RESTART_CHn_EN](#) field is enabled, upon receiving the [LEDC_TASK_GAMMA_RESTART_CHn](#) task, the PWM n restarts to generate the fading PWM signal.
- [LEDC_TASK_GAMMA_PAUSE_CHn](#): If the [LEDC_TASK_GAMMA_PAUSE_CHn_EN](#) field is enabled, upon receiving the [LEDC_TASK_GAMMA_PAUSE_CHn](#) task, PWM n suspends Duty Cycle Fading at the next timer overflow. That is, after the task has been received, PWM n keeps the duty cycle of the last fade.
- [LEDC_TASK_GAMMA_RESUME_CHn](#): If the [LEDC_TASK_GAMMA_RESUME_CHn_EN](#) field is enabled, upon receiving the [LEDC_TASK_GAMMA_RESUME_CHn](#) task, PWM n resumes Duty Cycle Fading at the next counter overflow. That is, after the task has been received, PWM n resumes fading from the range where the suspension occurs.

LEDC can generate the following ETM events:

- [LEDC_EVT_DUTY_CHNG_END_CHn](#): Generated when the [LEDC_EVT_DUTY_CHNG_END_CHn_EN](#) field is enabled, and PWM n has finished Duty Cycle Fading.

- `LEDC_EVT_OVF_CNT_PLS_CH n` : Generated when the `LEDC_EVT_OVF_CNT_PLS_CH n _EN` field is enabled and when PWM n timer's counter overflows for `LEDC_OVF_NUM_CH n + 1` times.
- `LEDC_EVT_TIME_OVF_TIMER x` : Generated when the `LEDC_EVT_TIME_OVF_TIMER x _EN` field is enabled and Timer x 's counter overflows.
- `LEDC_EVT_TIMER x _CMP`: Generated when the `LEDC_EVT_TIME x _CMP_EN` field is enabled and the value of Timer x 's counter reaches that of the `LEDC_TIMER x _CMP` field of register `LEDC_TIMER x _CMP_REG`.

In practical applications, LEDC's ETM events can trigger its own ETM tasks. For example, `LEDC_EVT_DUTY_CHNG_END_CH n` event can trigger the `LEDC_TASK_GAMMA_RESTART_CH n` task, thus starting the next fading directly after the current fading is completed.

34.3.6 Interrupts

- `LEDC_OVF_CNT_CH n _INT`: Triggered when the timer counter overflows for `LEDC_OVF_NUM_CH n + 1` times and the register `LEDC_OVF_CNT_EN_CH n` is set to 1. To trigger this interrupt, the field `LEDC_OVF_CNT_CH n _INT_ENA` of register `LEDC_INT_ENA_REG` should be set.
- `LEDC_DUTY_CHNG_END_CH n _INT`: Triggered when a fade on an LED PWM generator has finished. To trigger this interrupt, the field `LEDC_DUTY_CHNG_END_CH n _INT_ENA` of register `LEDC_INT_ENA_REG` should be set.
- `LEDC_TIMER x _OVF_INT`: Triggered when an LED PWM timer has reached its maximum counter value. To trigger this interrupt, the field `LEDC_TIMER x _OVF_INT_ENA` of register `LEDC_INT_ENA_REG` should be set.

34.4 Register Summary

The addresses in this section are relative to the LED PWM Controller base address provided in Table 5-2 in Chapter 5 *System and Memory*.

The abbreviations given in Column **Access** are explained in Section *Access Types for Registers*.

Name	Description	Address	Access
Configuration Register			
LEDC_CH0_CONF0_REG	Configuration register 0 for channel 0	0x0000	varies
LEDC_CH0_CONF1_REG	Configuration register 1 for channel 0	0x000C	R/W/SC
LEDC_CH1_CONF0_REG	Configuration register 0 for channel 1	0x0014	varies
LEDC_CH1_CONF1_REG	Configuration register 1 for channel 1	0x0020	R/W/SC
LEDC_CH2_CONF0_REG	Configuration register 0 for channel 2	0x0028	varies
LEDC_CH2_CONF1_REG	Configuration register 1 for channel 2	0x0034	R/W/SC
LEDC_CH3_CONF0_REG	Configuration register 0 for channel 3	0x003C	varies
LEDC_CH3_CONF1_REG	Configuration register 1 for channel 3	0x0048	R/W/SC
LEDC_CH4_CONF0_REG	Configuration register 0 for channel 4	0x0050	varies
LEDC_CH4_CONF1_REG	Configuration register 1 for channel 4	0x005C	R/W/SC
LEDC_CH5_CONF0_REG	Configuration register 0 for channel 5	0x0064	varies
LEDC_CH5_CONF1_REG	Configuration register 1 for channel 5	0x0070	R/W/SC
LEDC_EVT_TASK_EN0_REG	LEDC event task enable register 0	0x01A0	R/W
LEDC_EVT_TASK_EN1_REG	LEDC event task enable register 1	0x01A4	R/W
LEDC_EVT_TASK_EN2_REG	LEDC event task enable register 2	0x01A8	R/W
LEDC_TIMER0_CMP_REG	LEDC timer 0 value comparison register	0x01B0	R/W
LEDC_TIMER1_CMP_REG	LEDC timer 1 value comparison register	0x01B4	R/W
LEDC_TIMER2_CMP_REG	LEDC timer 2 value comparison register	0x01B8	R/W
LEDC_TIMER3_CMP_REG	LEDC timer 3 value comparison register	0x01BC	R/W
LEDC_TIMER0_CNT_CAP_REG	LEDC timer 0 counter value capture register	0x01C0	RO
LEDC_TIMER1_CNT_CAP_REG	LEDC timer 1 counter value capture register	0x01C4	RO
LEDC_TIMER2_CNT_CAP_REG	LEDC timer 2 counter value capture register	0x01C8	RO
LEDC_TIMER3_CNT_CAP_REG	LEDC timer 3 counter value capture register	0x01CC	RO
LEDC_CONF_REG	Global LEDC configuration register	0x01F0	R/W
Hpoint Register			
LEDC_CH0_HPOINT_REG	High point register for channel 0	0x0004	R/W
LEDC_CH1_HPOINT_REG	High point register for channel 1	0x0018	R/W
LEDC_CH2_HPOINT_REG	High point register for channel 2	0x002C	R/W
LEDC_CH3_HPOINT_REG	High point register for channel 3	0x0040	R/W
LEDC_CH4_HPOINT_REG	High point register for channel 4	0x0054	R/W
LEDC_CH5_HPOINT_REG	High point register for channel 5	0x0068	R/W
Duty Cycle Register			
LEDC_CH0_DUTY_REG	Initial duty cycle for channel 0	0x0008	R/W
LEDC_CH0_DUTY_R_REG	Current duty cycle for channel 0	0x0010	RO
LEDC_CH1_DUTY_REG	Initial duty cycle for channel 1	0x001C	R/W
LEDC_CH1_DUTY_R_REG	Current duty cycle for channel 1	0x0024	RO
LEDC_CH2_DUTY_REG	Initial duty cycle for channel 2	0x0030	R/W

Name	Description	Address	Access
LEDC_CH2_DUTY_R_REG	Current duty cycle for channel 2	0x0038	RO
LEDC_CH3_DUTY_REG	Initial duty cycle for channel 3	0x0044	R/W
LEDC_CH3_DUTY_R_REG	Current duty cycle for channel 3	0x004C	RO
LEDC_CH4_DUTY_REG	Initial duty cycle for channel 4	0x0058	R/W
LEDC_CH4_DUTY_R_REG	Current duty cycle for channel 4	0x0060	RO
LEDC_CH5_DUTY_REG	Initial duty cycle for channel 5	0x006C	R/W
LEDC_CH5_DUTY_R_REG	Current duty cycle for channel 5	0x0074	RO
Timer Register			
LEDC_TIMER0_CONF_REG	Timer 0 configuration	0x00A0	varies
LEDC_TIMER0_VALUE_REG	Timer 0 current counter value	0x00A4	RO
LEDC_TIMER1_CONF_REG	Timer 1 configuration	0x00A8	varies
LEDC_TIMER1_VALUE_REG	Timer 1 current counter value	0x00AC	RO
LEDC_TIMER2_CONF_REG	Timer 2 configuration	0x00B0	varies
LEDC_TIMER2_VALUE_REG	Timer 2 current counter value	0x00B4	RO
LEDC_TIMER3_CONF_REG	Timer 3 configuration	0x00B8	varies
LEDC_TIMER3_VALUE_REG	Timer 3 current counter value	0x00BC	RO
Interrupt Register			
LEDC_INT_RAW_REG	Raw interrupt status	0x00C0	R/WTC/SS
LEDC_INT_ST_REG	Masked interrupt status	0x00C4	RO
LEDC_INT_ENA_REG	Interrupt enable bits	0x00C8	R/W
LEDC_INT_CLR_REG	Interrupt clear bits	0x00CC	WT
Gamma RAM Register			
LEDC_CH0_GAMMA_WR_REG	LEDC channel 0 gamma RAM write register	0x0100	R/W
LEDC_CH0_GAMMA_WR_ADDR_REG	LEDC channel 0 gamma RAM write address register	0x0104	R/W
LEDC_CH0_GAMMA_RD_ADDR_REG	LEDC channel 0 gamma RAM read address register	0x0108	R/W
LEDC_CH0_GAMMA_RD_DATA_REG	LEDC channel 0 gamma RAM read data register	0x010C	RO
LEDC_CH1_GAMMA_WR_REG	LEDC channel 1 gamma RAM write register	0x0110	R/W
LEDC_CH1_GAMMA_WR_ADDR_REG	LEDC channel 1 gamma RAM write address register	0x0114	R/W
LEDC_CH1_GAMMA_RD_ADDR_REG	LEDC channel 1 gamma RAM read address register	0x0118	R/W
LEDC_CH1_GAMMA_RD_DATA_REG	LEDC channel 1 gamma RAM read data register	0x011C	RO
LEDC_CH2_GAMMA_WR_REG	LEDC channel 2 gamma RAM write register	0x0120	R/W
LEDC_CH2_GAMMA_WR_ADDR_REG	LEDC channel 2 gamma RAM write address register	0x0124	R/W
LEDC_CH2_GAMMA_RD_ADDR_REG	LEDC channel 2 gamma RAM read address register	0x0128	R/W
LEDC_CH2_GAMMA_RD_DATA_REG	LEDC channel 2 gamma RAM read data register	0x012C	RO
LEDC_CH3_GAMMA_WR_REG	LEDC channel 3 gamma RAM write register	0x0130	R/W

Name	Description	Address	Access
LEDC_CH3_GAMMA_WR_ADDR_REG	LEDC channel 3 gamma RAM write address register	0x0134	R/W
LEDC_CH3_GAMMA_RD_ADDR_REG	LEDC channel 3 gamma RAM read address register	0x0138	R/W
LEDC_CH3_GAMMA_RD_DATA_REG	LEDC channel 3 gamma RAM read data register	0x013C	RO
LEDC_CH4_GAMMA_WR_REG	LEDC channel 4 gamma RAM write register	0x0140	R/W
LEDC_CH4_GAMMA_WR_ADDR_REG	LEDC channel 4 gamma RAM write address register	0x0144	R/W
LEDC_CH4_GAMMA_RD_ADDR_REG	LEDC channel 4 gamma RAM read address register	0x0148	R/W
LEDC_CH4_GAMMA_RD_DATA_REG	LEDC channel 4 gamma RAM read data register	0x014C	RO
LEDC_CH5_GAMMA_WR_REG	LEDC channel 5 gamma RAM write register	0x0150	R/W
LEDC_CH5_GAMMA_WR_ADDR_REG	LEDC channel 5 gamma RAM write address register	0x0154	R/W
LEDC_CH5_GAMMA_RD_ADDR_REG	LEDC channel 5 gamma RAM read address register	0x0158	R/W
LEDC_CH5_GAMMA_RD_DATA_REG	LEDC channel 5 gamma RAM read data register	0x015C	RO
Gamma Configuration Register			
LEDC_CH0_GAMMA_CONF_REG	LEDC channel 0 gamma configuration register	0x0180	varies
LEDC_CH1_GAMMA_CONF_REG	LEDC channel 1 gamma configuration register	0x0184	varies
LEDC_CH2_GAMMA_CONF_REG	LEDC channel 2 gamma configuration register	0x0188	varies
LEDC_CH3_GAMMA_CONF_REG	LEDC channel 3 gamma configuration register	0x018C	varies
LEDC_CH4_GAMMA_CONF_REG	LEDC channel 4 gamma configuration register	0x0190	varies
LEDC_CH5_GAMMA_CONF_REG	LEDC channel 5 gamma configuration register	0x0194	varies
Version Register			
LEDC_DATE_REG	Version control register	0x01FC	R/W

34.5 Registers

The addresses in this section are relative to LED PWM Controller base address provided in Table 5-2 in Chapter 5 *System and Memory*.

Register 34.1. LEDC_CH n _CONF0_REG (n : 0-5) (0x0000+0x14* n)

(reserved)																	LEDC_OVF_CNT_RESET_CH0 LEDC_OVF_CNT_EN_CH0			LEDC_OVF_NUM_CH0			LEDC_PARA_UP_CH0 LEDC_IDLE_LV_CH0 LEDC_SIG_OUT_EN_CH0 LEDC_TIMER_SEL_CH0									
31																	17	16	15	14							5	4	3	2	1	0
0																	0	0	0			0	0	0	0	0	Reset					

LEDC_TIMER_SEL_CH n Configures the timer for channel n .

- 0: timer 0
 - 1: timer 1
 - 2: timer 2
 - 3: timer 3
- (R/W)

LEDC_SIG_OUT_EN_CH n Configures whether or not to enable signal output on channel n .

- 0: Disable
 - 1: Enable
- (R/W)

LEDC_IDLE_LV_CH n Configures the output level when channel n is inactive (when LEDC_SIG_OUT_EN_CH n is 0). (R/W)

LEDC_PARA_UP_CH n Configures whether or not to update LEDC_HPOINT_CH n , LEDC_DUTY_START_CH n , LEDC_SIG_OUT_EN_CH n , LEDC_TIMER_SEL_CH n , and LEDC_OVF_CNT_EN_CH n fields for channel n .

- 0: Invalid. No effect
 - 1: Update
- (WT)

LEDC_OVF_NUM_CH n Configures the maximum overflow times minus 1.

The LEDC_OVF_CNT_CH n _INT interrupt will be triggered when channel n overflows for LEDC_OVF_NUM_CH n + 1 times. (R/W)

LEDC_OVF_CNT_EN_CH n Configures whether or not to enable the overflow counter of channel n .

- 0: Disable
 - 1: Enable
- (R/W)

Continued on the next page...

Register 34.1. LEDC_CH n _CONF0_REG (n: 0-5) (0x0000+0x14*n)

Continued from the previous page...

LEDC_OVF_CNT_RESET_CH n Set this bit to reset the ovf_cnt of channel n .

- 0: Invalid. No effect
 - 1: Reset
- (WT)

Register 34.2. LEDC_CH n _CONF1_REG (n: 0-5) (0x000C+0x14*n)

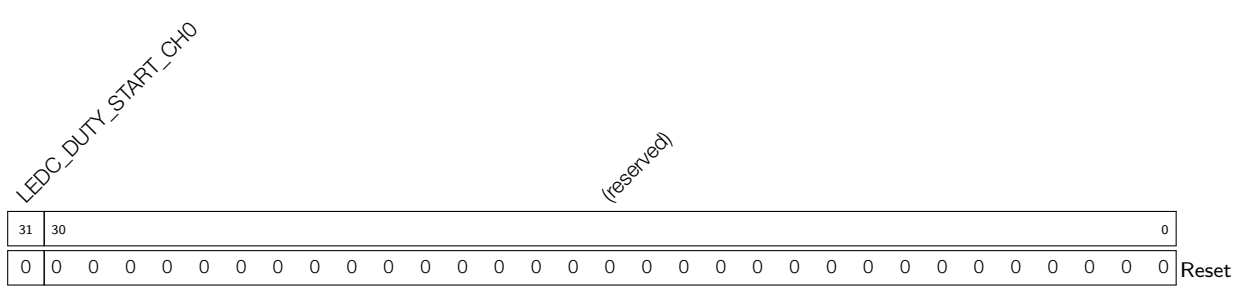

LEDC_DUTY_START_CH n Configures whether or not to enable duty cycle fading.

- 0: Disable
 - 1: Enable
- (R/W/SC)

Register 34.3. LEDC_EVT_TASK_EN0_REG (0x01A0)

(reserved)																																							
					LEDC_TASK_DUTY_SCALE_UPDATE_CH5_EN					LEDC_TASK_DUTY_SCALE_UPDATE_CH4_EN					LEDC_TASK_DUTY_SCALE_UPDATE_CH3_EN					LEDC_TASK_DUTY_SCALE_UPDATE_CH2_EN					LEDC_TASK_DUTY_SCALE_UPDATE_CH1_EN					LEDC_TASK_DUTY_SCALE_UPDATE_CH0_EN									
					LEDC_EVT_TIME3_CMP_EN					LEDC_EVT_TIME2_CMP_EN					LEDC_EVT_TIME1_CMP_EN					LEDC_EVT_TIME_OVF_TIMER3_EN					LEDC_EVT_TIME_OVF_TIMER2_EN					LEDC_EVT_TIME_OVF_TIMER1_EN					LEDC_EVT_TIME_OVF_TIMER0_EN				
(reserved)																																							
					LEDC_EVT_OVF_CNT_PLS_CH5_EN					LEDC_EVT_OVF_CNT_PLS_CH4_EN					LEDC_EVT_OVF_CNT_PLS_CH3_EN					LEDC_EVT_OVF_CNT_PLS_CH2_EN					LEDC_EVT_OVF_CNT_PLS_CH1_EN					LEDC_EVT_OVF_CNT_PLS_CH0_EN									
(reserved)																																							
					LEDC_EVT_DUTY_CHNG_END_CH5_EN					LEDC_EVT_DUTY_CHNG_END_CH4_EN					LEDC_EVT_DUTY_CHNG_END_CH3_EN					LEDC_EVT_DUTY_CHNG_END_CH2_EN					LEDC_EVT_DUTY_CHNG_END_CH1_EN					LEDC_EVT_DUTY_CHNG_END_CH0_EN									
31	30	29	28	27	26	25	24	23	22	21	20	19	18	17	16	15	14	13	12	11	10	9	8	7	6	5	4	3	2	1	0								
0	0	0	0	0	0	0	0	0	0	0	0	0	0	0	0	0	0	0	0	0	0	0	0	0	0	0	0	0	0	0	0								

Reset

LEDC_EVT_DUTY_CHNG_END_CH n _EN (n : 0-5) Configures whether or not to enable the LEDC_EVT_DUTY_CHNG_END_CH n event.

0: Disable

1: Enable

(R/W)

LEDC_EVT_OVF_CNT_PLS_CH n _EN (n : 0-5) Configures whether or not to enable the LEDC_EVT_OVF_CNT_PLS_CH n event.

0: Disable

1: Enable

(R/W)

LEDC_EVT_TIME_OVF_TIMER x _EN (x : 0-3) Configures whether or not to enable the LEDC_EVT_TIME_OVF_TIMER x event event.

0: Disable

1: Enable

(R/W)

LEDC_EVT_TIME x _CMP_EN (x : 0-3) Configures whether or not to enable the LEDC_EVT_TIMER x _CMP event.

0: Disable

1: Enable

(R/W)

LEDC_TASK_DUTY_SCALE_UPDATE_CH n _EN (n : 0-5) Configures whether or not to enable the LEDC_TASK_DUTY_SCALE_UPDATE_CH n task.

0: Disable

1: Enable

(R/W)

Register 34.4. LEDC_EVT_TASK_EN1_REG (0x01A4)

LEDC_TASK_TIMER3_PAUSE_RESUME_EN																														
LEDC_TASK_TIMER2_PAUSE_RESUME_EN																														
LEDC_TASK_TIMER1_PAUSE_RESUME_EN																														
LEDC_TASK_TIMER0_PAUSE_RESUME_EN																														
LEDC_TASK_TIMER3_RST_EN																														
LEDC_TASK_TIMER2_RST_EN																														
LEDC_TASK_TIMER1_RST_EN																														
LEDC_TASK_TIMER0_RST_EN																														
(reserved)																														
LEDC_TASK_OVF_CNT_RST_CH5_EN																														
LEDC_TASK_OVF_CNT_RST_CH4_EN																														
LEDC_TASK_OVF_CNT_RST_CH3_EN																														
LEDC_TASK_OVF_CNT_RST_CH2_EN																														
LEDC_TASK_OVF_CNT_RST_CH1_EN																														
LEDC_TASK_OVF_CNT_RST_CH0_EN																														
(reserved)																														
LEDC_TASK_SIG_OUT_DIS_CH5_EN																														
LEDC_TASK_SIG_OUT_DIS_CH4_EN																														
LEDC_TASK_SIG_OUT_DIS_CH3_EN																														
LEDC_TASK_SIG_OUT_DIS_CH2_EN																														
LEDC_TASK_TIMER3_CAP_EN																														
LEDC_TASK_TIMER2_CAP_EN																														
LEDC_TASK_TIMER1_CAP_EN																														
LEDC_TASK_TIMER0_CAP_EN																														
LEDC_TASK_TIMER3_RES_UPDATE_EN																														
LEDC_TASK_TIMER2_RES_UPDATE_EN																														
LEDC_TASK_TIMER1_RES_UPDATE_EN																														
LEDC_TASK_TIMER0_RES_UPDATE_EN																														

31	30	29	28	27	26	25	24	23	22	21	20	19	18	17	16	15	14	13	12	11	10	9	8	7	6	5	4	3	2	1	0
0	0	0	0	0	0	0	0	0	0	0	0	0	0	0	0	0	0	0	0	0	0	0	0	0	0	0	0	0	0	0	0

Reset

LEDC_TASK_TIMER x _RES_UPDATE_EN (x : 0-3) Configures whether or not to enable the LEDC_TASK_TIMER x _RES_UPDATE task.

- 0: Disable
 - 1: Enable
- (R/W)

LEDC_TASK_TIMER x _CAP_EN (x : 0-3) Configures whether or not to enable the LEDC_TASK_TIMER x _CAP task.

- 0: Disable
 - 1: Enable
- (R/W)

LEDC_TASK_SIG_OUT_DIS_CH n _EN (n : 0-5) Configures whether or not to enable the LEDC_TASK_SIG_OUT_DIS_CH n task.

- 0: Disable
 - 1: Enable
- (R/W)

LEDC_TASK_OVF_CNT_RST_CH n _EN (n : 0-5) Configures whether or not to enable the LEDC_TASK_OVF_CNT_RST_CH n task.

- 0: Disable
 - 1: Enable
- (R/W)

LEDC_TASK_TIMER x _RST_EN (x : 0-3) Configures whether or not to enable the LEDC_TASK_TIMER x _RST task.

- 0: Disable
 - 1: Enable
- (R/W)

LEDC_TASK_TIMER x _PAUSE_RESUME_EN (x : 0-3) Configures whether or not to enable the LEDC_TASK_TIMER x _RESUME and LEDC_TASK_TIMER x _PAUSE task.

- 0: Disable
 - 1: Enable
- (R/W)

Register 34.5. LEDC_EVT_TASK_EN2_REG (0x01A8)

31	22	21	20	19	18	17	16	15	14	13	12	11	10	9	8	7	6	5	4	3	2	1	0	Reset	
0	0	0	0	0	0	0	0	0	0	0	0	0	0	0	0	0	0	0	0	0	0	0	0	0	0

(reserved)
LEDC_TASK_GAMMA_RESUME_CH5_EN
LEDC_TASK_GAMMA_RESUME_CH4_EN
LEDC_TASK_GAMMA_RESUME_CH3_EN
LEDC_TASK_GAMMA_RESUME_CH2_EN
LEDC_TASK_GAMMA_RESUME_CH1_EN
LEDC_TASK_GAMMA_RESUME_CH0_EN
(reserved)
LEDC_TASK_GAMMA_PAUSE_CH5_EN
LEDC_TASK_GAMMA_PAUSE_CH4_EN
LEDC_TASK_GAMMA_PAUSE_CH3_EN
LEDC_TASK_GAMMA_PAUSE_CH2_EN
LEDC_TASK_GAMMA_PAUSE_CH1_EN
LEDC_TASK_GAMMA_PAUSE_CH0_EN
(reserved)
LEDC_TASK_GAMMA_RESTART_CH5_EN
LEDC_TASK_GAMMA_RESTART_CH4_EN
LEDC_TASK_GAMMA_RESTART_CH3_EN
LEDC_TASK_GAMMA_RESTART_CH2_EN
LEDC_TASK_GAMMA_RESTART_CH1_EN
LEDC_TASK_GAMMA_RESTART_CH0_EN

LEDC_TASK_GAMMA_RESTART_CH n _EN (n : 0-5) Configures whether or not to enable the LEDC_TASK_GAMMA_RESTART_CH n task.

- 0: Disable
 - 1: Enable
- (R/W)

LEDC_TASK_GAMMA_PAUSE_CH n _EN (n : 0-5) Configures whether or not to enable the LEDC_TASK_GAMMA_PAUSE_CH n task.

- 0: Disable
 - 1: Enable
- (R/W)

LEDC_TASK_GAMMA_RESUME_CH n _EN (n : 0-5) Configures whether or not to enable the LEDC_TASK_GAMMA_RESUME_CH n task.

- 0: Disable
 - 1: Enable
- (R/W)

Register 34.6. LEDC_TIMER x _CMP_REG (x : 0-3) (0x01B0+0x4* x)

31	20	19	0	Reset
0	0	0	0	0x000

(reserved)
LEDC_TIMER0_CMP

LEDC_TIMER x _CMP Configures the comparison value for LEDC timer x . (R/W)

Register 34.7. LEDC_TIMER x _CNT_CAP_REG (x : 0-3) (0x01C0+0x4 x)

(reserved)										LEDC_TIMER0_CNT_CAP													
31											20	19											0
0 0 0 0 0 0 0 0 0 0										0x000										Reset			

LEDC_TIMER x _CNT_CAP Represents the captured LEDC timer x counter value. (RO)

Register 34.8. LEDC_CONF_REG (0x01F0)

(reserved)										LEDC_TIMER0_CNT_CAP																				
LEDC_CLK_EN										(reserved)										LEDC_TIMER0_CNT_CAP										
31											8	7	6	5	4	3	2	1	0											
0 0 0 0 0 0 0 0 0 0										0 0 0 0 0 0 0 0 0 0										0 0 0 0 0 0 0 0 0 0										Reset

LEDC_SCLK_SEL Configures the clock source for the four timers.

- 0: PLL_F80M_CLK
 - 1: RC_FAST_CLK
 - 2: XTAL_CLK
 - 3: Invalid. No effect
- (R/W)

LEDC_GAMMA_RAM_CLK_EN_CH n (n : 0-5) Configures when to enable register clock.

- 0: Support clock only when application reads or writes gamma RAM.
 - 1: Force clock on for gamma RAM.
- (R/W)

LEDC_CLK_EN Configures when to enable register clock.

- 0: Support clock only when application writes registers.
 - 1: Force clock on for registers.
- (R/W)

Register 34.9. LEDC_CH n _HPOINT_REG (n : 0-5) (0x0004+0x14* n)

(reserved)								LEDC_HPOINT_CH0													
31								20	19												0
0 0 0 0 0 0 0 0								0x000												Reset	

LEDC_HPOINT_CH n Configures the value of Hpoint. (R/W)

Register 34.10. LEDC_CH n _DUTY_REG (n : 0-5) (0x0008+0x14* n)

(reserved)								LEDC_DUTY_CH0													
31								25	24												0
0 0 0 0 0 0 0 0								0x00000												Reset	

LEDC_DUTY_CH n Configures the initial value of Lpoint. (R/W)

Register 34.11. LEDC_CH n _DUTY_R_REG (n : 0-5) (0x0010+0x14* n)

(reserved)								LEDC_DUTY_CH0_R													
31								25	24												0
0 0 0 0 0 0 0 0								0x00000												Reset	

LEDC_DUTY_CH n _R Represents the current duty cycle of the output signal on channel n . (RO)

Register 34.12. LEDC_TIMER x _CONF_REG (x : 0-3) (0x00A0+0x8 x)

(reserved)					LEDC_TIMER0_PARA_UP (reserved)				LEDC_TIMER0_RST LEDC_TIMER0_PAUSE				LEDC_CLK_DIV_TIMER0								LEDC_TIMER0_DUTY_RES			
31	27	26	25	24	23	22									5	4	0							
0	0	0	0	0	0	0	0	0	1	0	0x000								0x0					

Reset

LEDC_TIMER x _DUTY_RES Configures the duty cycle resolution (the width of the counter in timer x).
(R/W)

LEDC_CLK_DIV_TIMER x Configures the divisor for the divider in timer x .
The least significant eight bits represent the fractional part. The most significant ten bits represent the integer part. (R/W)

LEDC_TIMER x _PAUSE Configures whether or not to suspend the counter in timer x .
0: Not suspend
1: Suspend
(R/W)

LEDC_TIMER x _RST Configures whether or not to reset timer x (the counter will show 0 after reset).
0: Not reset
1: Reset
(R/W)

LEDC_TIMER x _PARA_UP Configures whether or not to update LEDC_CLK_DIV_TIMER x and LEDC_TIMER x _DUTY_RES.
0: Invalid. No effect
1: Update
(WT)

Register 34.13. LEDC_TIMER x _VALUE_REG (x : 0-3) (0x00A4+0x8 x)

(reserved)												LEDC_TIMER0_CNT																			
31												20	19	0																	0
0	0	0	0	0	0	0	0	0	0	0	0	0	0																	0	

Reset

LEDC_TIMER x _CNT Represents the current counter value of timer x . (RO)

Register 34.14. LEDC_INT_RAW_REG (0x00C0)

(reserved)																		LEDC_OVF_CNT_CH5_INT_RAW LEDC_OVF_CNT_CH4_INT_RAW LEDC_OVF_CNT_CH3_INT_RAW LEDC_OVF_CNT_CH2_INT_RAW LEDC_OVF_CNT_CH1_INT_RAW LEDC_OVF_CNT_CH0_INT_RAW (reserved) LEDC_DUTY_CHNG_END_CH5_INT_RAW LEDC_DUTY_CHNG_END_CH4_INT_RAW LEDC_DUTY_CHNG_END_CH3_INT_RAW LEDC_DUTY_CHNG_END_CH2_INT_RAW LEDC_DUTY_CHNG_END_CH1_INT_RAW LEDC_DUTY_CHNG_END_CH0_INT_RAW LEDC_TIMER3_OVF_INT_RAW LEDC_TIMER2_OVF_INT_RAW LEDC_TIMER1_OVF_INT_RAW LEDC_TIMER0_OVF_INT_RAW													
31	18	17	16	15	14	13	12	11	10	9	8	7	6	5	4	3	2	1	0												
0	0	0	0	0	0	0	0	0	0	0	0	0	0	0	0	0	0	0	0	0											

Reset

LEDC_TIMER x _OVF_INT_RAW (x : 0-3) The raw interrupt status of LEDC_TIMER x _OVF_INT. (R/WTC/SS)

LEDC_DUTY_CHNG_END_CH n _INT_RAW (n : 0-5) The raw interrupt status of LEDC_DUTY_CHNG_END_CH n _INT. (R/WTC/SS)

LEDC_OVF_CNT_CH n _INT_RAW (n : 0-5) The raw interrupt status of LEDC_OVF_CNT_CH n _INT. (R/WTC/SS)

Register 34.15. LEDC_INT_ST_REG (0x00C4)

(reserved)																		LEDC_OVF_CNT_CH5_INT_ST LEDC_OVF_CNT_CH4_INT_ST LEDC_OVF_CNT_CH3_INT_ST LEDC_OVF_CNT_CH2_INT_ST LEDC_OVF_CNT_CH1_INT_ST LEDC_OVF_CNT_CH0_INT_ST (reserved) LEDC_DUTY_CHNG_END_CH5_INT_ST LEDC_DUTY_CHNG_END_CH4_INT_ST LEDC_DUTY_CHNG_END_CH3_INT_ST LEDC_DUTY_CHNG_END_CH2_INT_ST LEDC_DUTY_CHNG_END_CH1_INT_ST LEDC_DUTY_CHNG_END_CH0_INT_ST LEDC_TIMER3_OVF_INT_ST LEDC_TIMER2_OVF_INT_ST LEDC_TIMER1_OVF_INT_ST LEDC_TIMER0_OVF_INT_ST													
31	18	17	16	15	14	13	12	11	10	9	8	7	6	5	4	3	2	1	0												
0	0	0	0	0	0	0	0	0	0	0	0	0	0	0	0	0	0	0	0	0											

Reset

LEDC_TIMER x _OVF_INT_ST (x : 0-3) The masked interrupt status of LEDC_TIMER x _OVF_INT. Valid only when LEDC_TIMER x _OVF_INT_ENA is 1. (RO)

LEDC_DUTY_CHNG_END_CH n _INT_ST (n : 0-5) The masked interrupt status of LEDC_DUTY_CHNG_END_CH n _INT. Valid only when LEDC_DUTY_CHNG_END_CH n _INT_ENA is 1. (RO)

LEDC_OVF_CNT_CH n _INT_ST (n : 0-5) The masked interrupt status of LEDC_OVF_CNT_CH n _INT. Valid only when LEDC_OVF_CNT_CH n _INT_ENA is 1. (RO)

Register 34.16. LEDC_INT_ENA_REG (0x00C8)

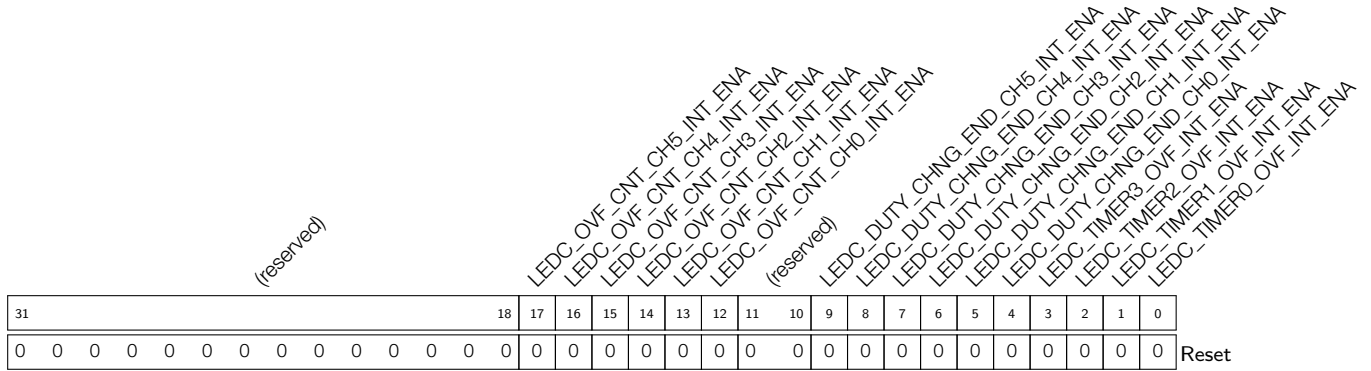

- LEDC_TIMER x _OVF_INT_ENA (x : 0-3)** Write 1 to enable LEDC_TIMER x _OVF_INT. (R/W)
- LEDC_DUTY_CHNG_END_CH n _INT_ENA (n : 0-5)** Write 1 to enable LEDC_DUTY_CHNG_END_CH n _INT. (R/W)
- LEDC_OVF_CNT_CH n _INT_ENA (n : 0-5)** Write 1 to enable LEDC_OVF_CNT_CH n _INT. (R/W)

Register 34.17. LEDC_INT_CLR_REG (0x00CC)

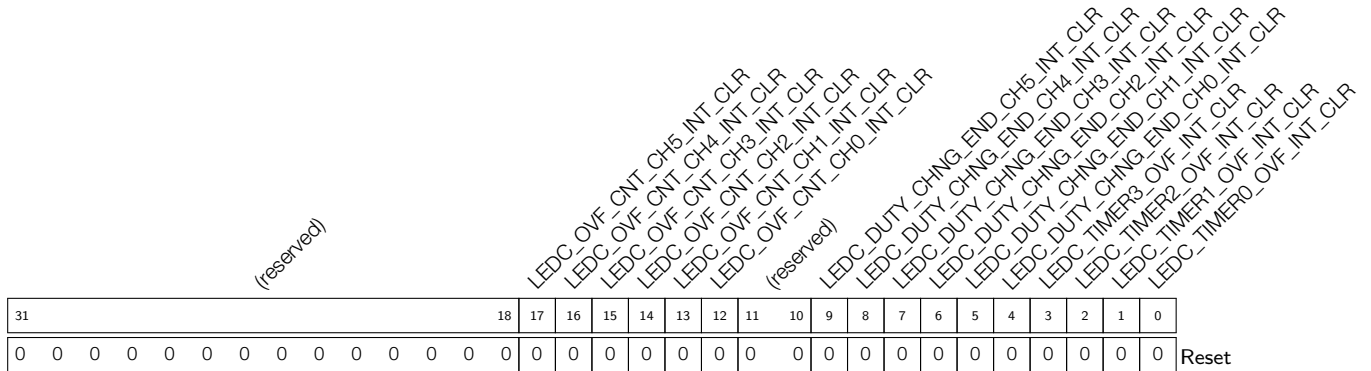

- LEDC_TIMER x _OVF_INT_CLR (x : 0-3)** Write 1 to clear LEDC_TIMER x _OVF_INT. (WT)
- LEDC_DUTY_CHNG_END_CH n _INT_CLR (n : 0-5)** Write 1 to clear LEDC_DUTY_CHNG_END_CH n _INT. (WT)
- LEDC_OVF_CNT_CH n _INT_CLR (n : 0-5)** Write 1 to clear LEDC_OVF_CNT_CH n _INT. (WT)

Register 34.18. LEDC_CH n _GAMMA_WR_REG (n : 0-5) (0x0100+0x10* n)

(reserved)		LEDC_CH0_GAMMA_DUTY_NUM				LEDC_CH0_GAMMA_SCALE				LEDC_CH0_GAMMA_DUTY_CYCLE				LEDC_CH0_GAMMA_DUTY_INC		
31	30	21	20	11	10	1	0									
0		0x0				0x0				0x0				0	0	Reset

LEDC_CH n _GAMMA_DUTY_INC Configures the direction of duty cycle fading for PWM signals on channel n .

0: Decrease.

1: Increase

(R/W)

LEDC_CH n _GAMMA_DUTY_CYCLE Configures the number of times the counter overflows per an duty cycle fade. (R/W)

LEDC_CH n _GAMMA_SCALE Configures the amount by which Lpoint n increase or decrease each time. (R/W)

LEDC_CH n _GAMMA_DUTY_NUM Configures the number of fades in a duty cycle range. (R/W)

Register 34.19. LEDC_CH n _GAMMA_WR_ADDR_REG (n : 0-5) (0x0104+0x10* n)

(reserved)																LEDC_CH0_GAMMA_WR_ADDR				
31															4	3	0			
0 0																0	0	0	0	Reset

LEDC_CH n _GAMMA_WR_ADDR Configures LEDC channel n gamma RAM write address. (R/W)

Register 34.20. LEDC_CH n _GAMMA_RD_ADDR_REG (n : 0-5) (0x0108+0x10* n)

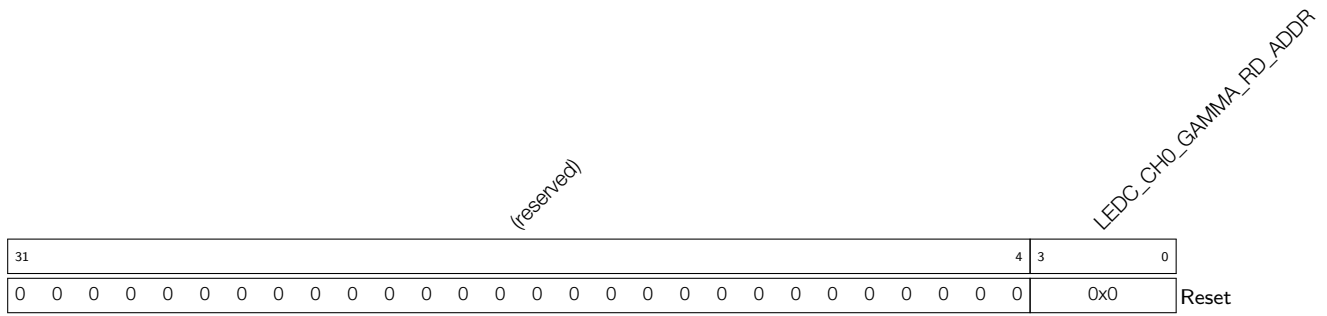

LEDC_CH n _GAMMA_RD_ADDR Configures LEDC channel n gamma RAM read address. (R/W)

Register 34.21. LEDC_CH n _GAMMA_RD_DATA_REG (n : 0-5) (0x010C+0x10* n)

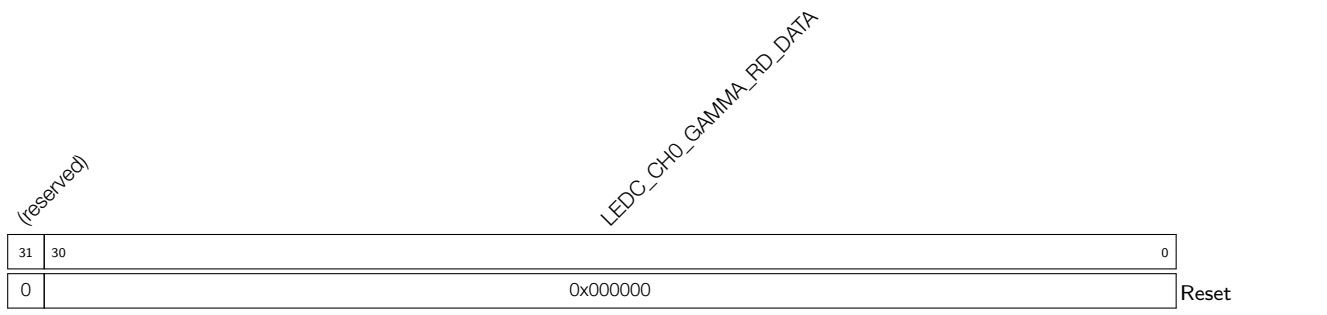

LEDC_CH n _GAMMA_RD_DATA Represents data read from gamma RAM via LEDC channel n . (RO)

Register 34.22. LEDC_CH n _GAMMA_CONF_REG (n : 0-5) (0x0180+0x4* n)

(reserved)															LEDC_CH0_GAMMA_RESUME		LEDC_CH0_GAMMA_PAUSE		LEDC_CH0_GAMMA_ENTRY_NUM	
31																7	6	5	4	0
0 0															0	0	0x0		Reset	

LEDC_CH n _GAMMA_ENTRY_NUM Configures the number of duty cycle ranges. Maximum value is 16. (R/W)

LEDC_CH n _GAMMA_PAUSE Configures whether or not to pause duty cycle fading.

0: Invalid. No effect

1: Pause

(WT)

LEDC_CH n _GAMMA_RESUME Configures whether or not to resume duty cycle fading.

0: Invalid. No effect

1: Resume

(WT)

Register 34.23. LEDC_DATE_REG (0x01FC)

(reserved)				LEDC_LEDC_DATE												
31	28	27	0													
0	0	0	0	0x2111150												Reset

LEDC_LEDC_DATE Version control register. (R/W)

35 Motor Control PWM (MCPWM)

35.1 Overview

The **M**otor **C**ontrol **P**ulse **W**idth **M**odulator (MCPWM) peripheral is intended for motor and power control. It provides six PWM outputs that can be set up to operate in several topologies. One common topology uses a pair of PWM outputs driving an H-bridge to control motor rotation speed and rotation direction.

The MCPWM can be divided into five main modules: PWM timers, PWM operators, Capture module, Event Task Matrix (ETM) module, and Fault Detection module. Each PWM timer provides timing references that can either run freely or be synced to other timers or external sources. Each PWM operator has all necessary control resources to generate waveform pairs for one PWM channel. The Capture module is used for systems that need to accurately time external events. The ETM module responds to tasks received by the MCPWM, generating corresponding events depending on the state of motion. The Fault Detection module is used to capture external faults, allowing the system to respond by choice.

ESP32-C6 has one MCPWM peripheral, which is MCPWM0.

35.2 Features

An MCPWM peripheral has one clock divider (prescaler), three PWM timers, three PWM operators, a Capture module, an ETM module, and a Fault Detection module. MCPWM's core clock can be selected from three clock sources: PLL_F160M_CLK, XTAL_CLK, and RC_FAST_CLK (configured by PWM_CLKM_SEL field in PCR register). Figure 35-1 shows the submodules inside MCPWM and the signals on the interface. PWM timers are used for generating timing references. The PWM operators generate the desired waveform based on the timing references. Any PWM operator can be configured to use the timing references of any PWM timers. Different PWM operators can use the same PWM timer's timing reference to generate PWM signals, or different PWM timers' values to generate separate PWM signals. Different PWM timers can also be synchronized together.

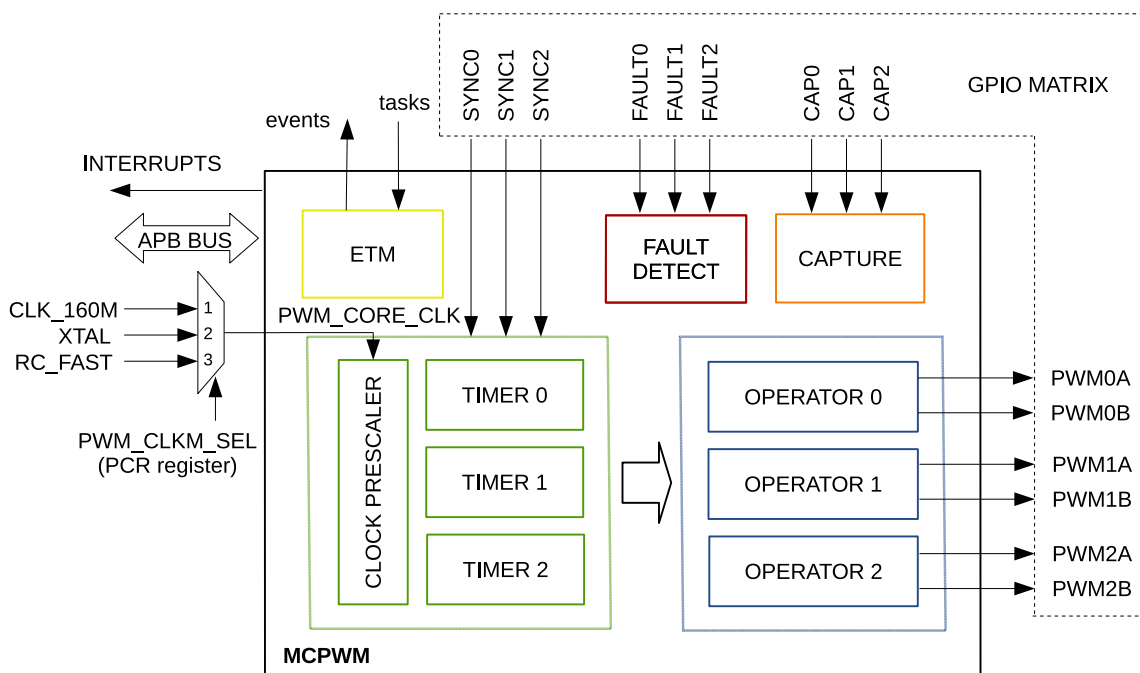

Figure 35-1. MCPWM Module Overview

Below is an overview of the submodules' functionality in Figure 35-1:

- PWM Timers 0, 1, and 2:
 - Every PWM timer has a dedicated 8-bit clock prescaler.
 - The 16-bit counter in the PWM timer can work in count-up mode, count-down mode, or count-up-down mode.
 - A hardware sync or software sync can trigger a reload on the PWM timer with a phase register. It will also trigger the prescaler's restart, so that the timer's clock can also be synced. The source of the hard sync can come from any GPIO or any other PWM timer's sync_out. The source of the soft sync comes from writing toggle value to the `MCPWM_TIMERx_SYNC_SW` bit.
- PWM Operators 0, 1, and 2:
 - Every PWM operator has two PWM outputs: PWMxA and PWMxB. They can work independently, in symmetric or asymmetric configurations.
 - The control of the PWM signal can be updated asynchronously.
 - Configurable dead time on rising and falling edges; each set up independently.
 - All events can trigger CPU interrupts.
 - Modulating of PWM output by high-frequency carrier signals, useful when gate drivers are insulated with a transformer.
 - Period, time stamps, and important control registers have shadow registers with flexible updating methods.
- Fault Detection Module:
 - Programmable fault handling in both cycle-by-cycle mode and one-shot mode.
 - A fault condition can force the PWM output to either high or low logic levels.
- Capture Module:
 - Clock of the capture module is the same as MCPWM's core clock.
 - Speed measurement of rotating machinery.
 - Measurement of elapsed time between position sensor pulses
 - Period and duty cycle measurement of pulse train signals
 - Decoding current or voltage amplitude derived from duty-cycle-encoded signals of current/voltage sensors
 - Three individual capture channels, each of which with a time-stamp register (32-bit)
 - Selection of edge polarity and prescaling of input capture signals
 - The capture timer can sync with a PWM timer or external signals.
 - Interrupt on each of the three capture channels
- ETM Module:
 - Generation of different events depending on the different running states of each timer and operator.

- Each timer and operator responds to its corresponding task and automatically performs the corresponding operation.
- Each event and task can be enabled independently. When an event is not enabled, the corresponding event will not be generated. When a task is not enabled, the corresponding task will not be responded to.

35.3 Modules

35.3.1 Overview

This section lists the configuration parameters of key modules. For information on adjusting a specific parameter, e.g. synchronization source of PWM timer, please refer to Section 35.3.2 for details.

35.3.1.1 Prescaler Module



Figure 35-2. Prescaler Module

Configuration option:

- Scale the PWM_CORE_CLK.

35.3.1.2 Timer Module

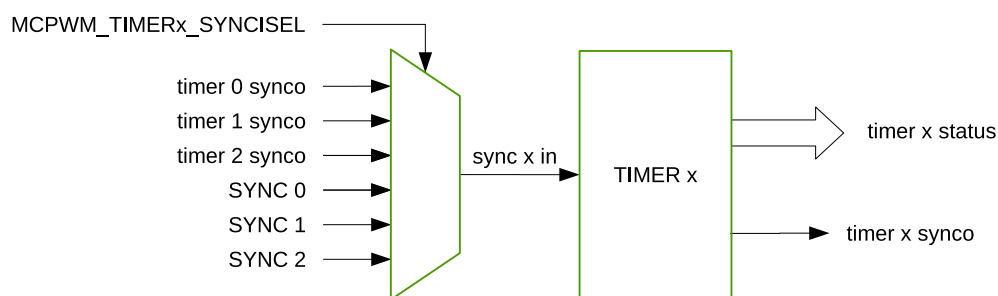

Figure 35-3. Timer Module

Configuration options:

- Configure the PWM timer frequency or period.
- Configure the working mode for the timer:
 - Count-Up Mode: for asymmetric PWM outputs
 - Count-Down Mode: for asymmetric PWM outputs
 - Count-Up-Down Mode: for symmetric PWM outputs
- Configure the reloading phase (including the value and the direction) used during software and hardware synchronization.
- Synchronize the PWM timers with each other. Either hardware or software synchronization may be used.
- Configure the source of the PWM timer's the synchronization input to one of the seven sources below:
 - The three PWM timer's synchronization outputs.
 - Three synchronization signals from the GPIO matrix: PWMn_SYNC0_IN, PWMn_SYNC1_IN, PWMn_SYNC2_IN.
 - No synchronization input signal selected

- Configure the source of the PWM timer’s synchronization output to one of the four sources below:
 - Synchronization input signal
 - Event generated when the value of the PWM timer is equal to zero
 - Event generated when the value of the PWM timer is equal to the period
 - Event generated when writing toggle value to `MCPWM_TIMERx_SYNC_SW` bit
- Configure the method of period updating.

35.3.1.3 Operator Module

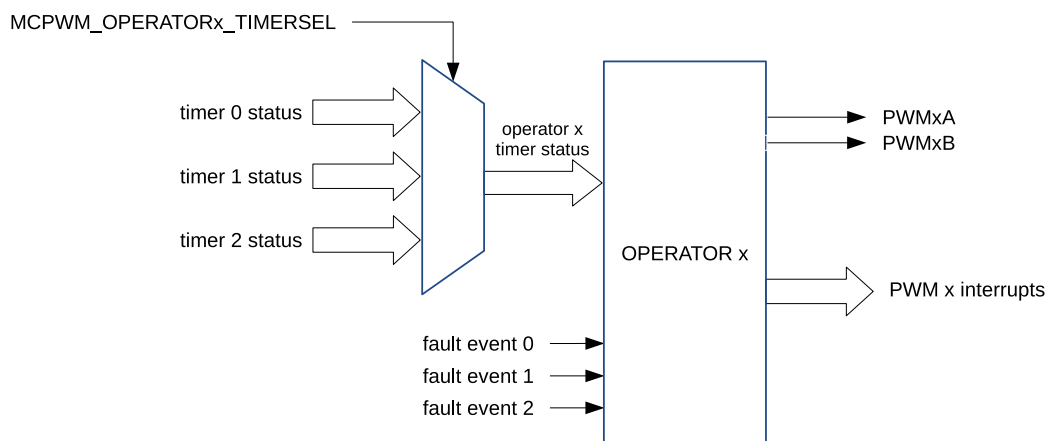

Figure 35-4. Operator Module

The configuration parameters of the operator module are shown in Table 35-1.

Table 35-1. Configuration Parameters of the Operator Submodule

Submodule	Configuration Parameter or Option
PWM Generator	<ul style="list-style-type: none"> • Configure the PWM duty cycle for PWMxA and/or PWMxB output. • Configure at which time the timing events occur. • Configure what action should be taken on timing events: <ul style="list-style-type: none"> – Switch high or low of PWMxA and/or PWMxB outputs – Toggle PWMxA and/or PWMxB outputs – Take no action on outputs • Use direct s/w control to force the state of PWM outputs • Add a dead time to raising edge and/or falling edge on PWM outputs. • Configure update method for this submodule.

Submodule	Configuration Parameter or Option
Dead Time Generator	<ul style="list-style-type: none"> • Control of complementary dead time relationship between upper and lower switches. • Specify the dead time on rising edge. • Specify the dead time on falling edge. • Bypass the dead time generator module. The PWM waveform will pass through without inserting dead time. • Allow PWM_xB phase shifting with respect to the PWM_xA output. • Configure updating method for this submodule.
PWM Carrier	<ul style="list-style-type: none"> • Enable carrier and set up carrier frequency. • Configure duration of the first pulse in the carrier waveform. • Configure the duty cycle of the following pulses. • Bypass the PWM carrier module. The PWM waveform will be passed through without modification.
Fault Handler	<ul style="list-style-type: none"> • Configure if and how the PWM module should react the fault event signals. • Specify the action taken when a fault event occurs: <ul style="list-style-type: none"> – Force PWM_xA and/or PWM_xB high. – Force PWM_xA and/or PWM_xB low. – Configure PWM_xA and/or PWM_xB to ignore any fault event. • Configure how often the PWM should react to fault events: <ul style="list-style-type: none"> – One-shot – Cycle-by-cycle • Generate interrupts. • Bypass the fault handler submodule entirely. • Configure an option for cycle-by-cycle actions clearing. • If desired, independently-configured actions can be taken when time-base counter is counting down or up.

35.3.1.4 Fault Detection Module

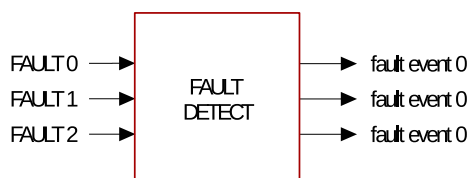

Figure 35-5. Fault Detection Module

Configuration options:

- Enable fault event generation and configure the polarity of fault event generated for every fault signal.
- Generate fault event interrupts.

35.3.1.5 Capture Module

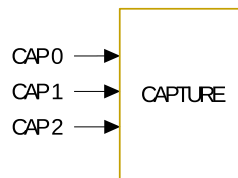

Figure 35-6. Capture Module

Configuration options:

- Select the edge polarity and prescale the capture input.
- Set up a software-triggered capture.
- Configure the capture timer's sync trigger and sync phase.
- Software syncs the capture timer.

35.3.1.6 ETM Module

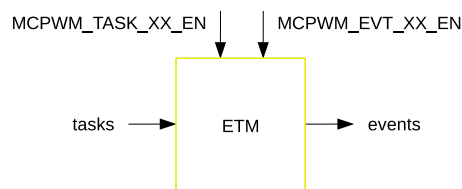

Figure 35-7. ETM Module

Configuration options:

- Each event and task can be enabled independently. When an event is not enabled, the corresponding event will not be generated. When a task is not enabled, the corresponding task will not be responded to.

35.3.2 PWM Timer Module

MCPWM has three PWM timer modules. Any of them can determine the necessary event timing for any of the three PWM operator modules. By using the synchronization signals from the GPIO matrix, built-in synchronization logic allows multiple PWM timer modules in one or more MCPWM peripherals to work together as a system.

35.3.2.1 Configurations of the PWM Timer Module

Users can configure the following functions of the PWM timer module:

- Control how often events occur by specifying the PWM timer frequency or period.

- Configure a particular PWM timer to synchronize with other PWM timers or modules.
- Get a PWM timer in phase with other PWM timers or modules.
- Configure the following timer counting modes: count-up, count-down, count-up-down.
- Change the rate of the PWM timer clock (PT_clk) with a prescaler. Each timer has its own prescaler configured with `MCPWM_TIMERx_PRESCALE` of the register `MCPWM_TIMER0_CFG0_REG`. The PWM timer increments or decrements at a slower pace, depending on the setting of this field. The new `MCPWM_TIMERx_PRESCALE` configuration value will take effect when the timer stops and starts counting again.

35.3.2.2 PWM Timer's Working Modes and Timing Event Generation

The PWM timer has three working modes, selected by the PWM_x timer mode field:

- **Count-Up Mode:**
The PWM timer increments from zero until reaching the value configured in the period field. Once done, the PWM timer returns to zero and starts increasing again. PWM period = the value of the period field + 1.
Note: The period field is `MCPWM_TIMERx_PERIOD` ($x = 0, 1, 2$), i.e., `MCPWM_TIMER0_PERIOD`, `MCPWM_TIMER1_PERIOD`, `MCPWM_TIMER2_PERIOD`.
- **Count-Down Mode:**
The PWM timer decrements to zero, starting from the value configured in the period field. Once done, the PWM timer returns to the period value and starts decrementing again. In this case, the PWM period = the value of period field + 1.
- **Count-Up-Down Mode:**
This is a combination of the two modes mentioned above. The PWM timer starts increasing from zero until the period value is reached. Then, the timer decreases back to zero. The PWM timer cycles incrementally and decrementally in this mode. The PWM period = the value of the period field × 2.

Figures 35-8 to 35-11 show PWM timer waveforms in different modes, including timer behavior during synchronization events. In Count-Up mode, the counting direction after synchronization is always counting up. In Count-Down mode, the counting direction after synchronization is always counting down. In Count-Up-Down Mode, the counting direction after synchronization can be chosen by setting the `MCPWM_TIMERx_PHASE_DIRECTION`.

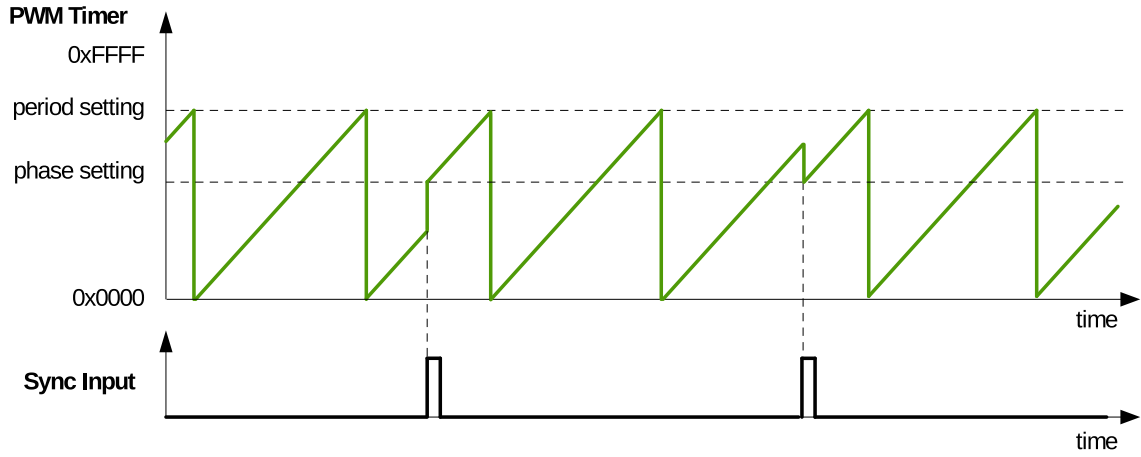

Figure 35-8. Count-Up Mode Waveform

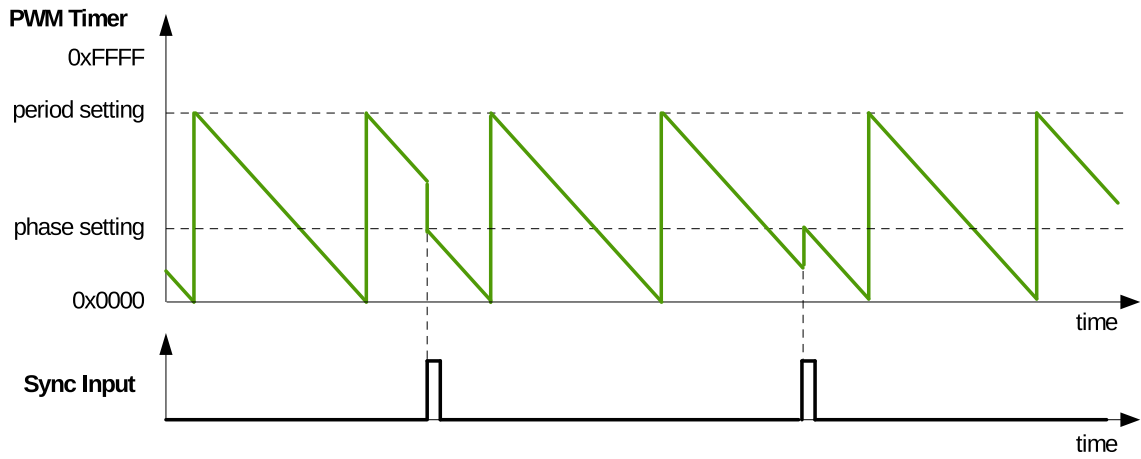

Figure 35-9. Count-Down Mode Waveforms

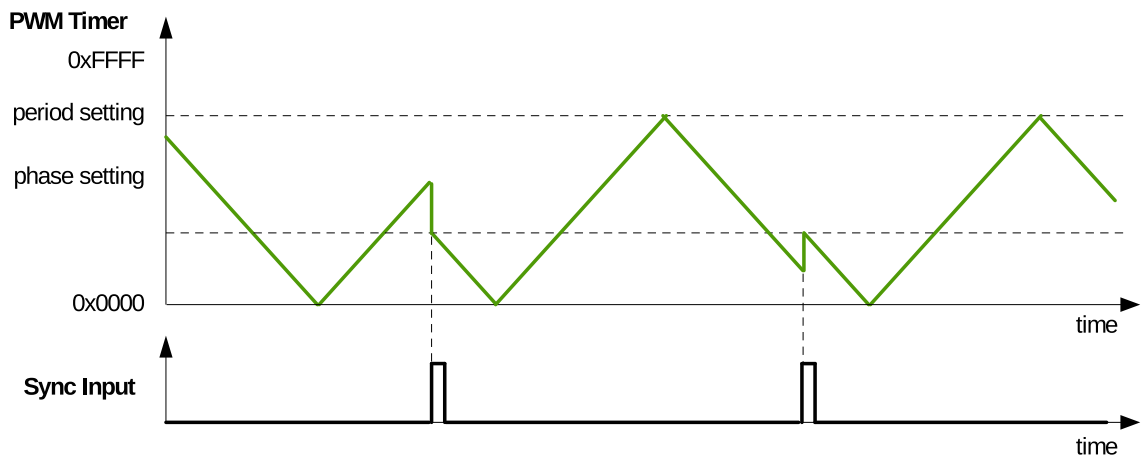

Figure 35-10. Count-Up-Down Mode Waveforms, Count-Down at Synchronization Event

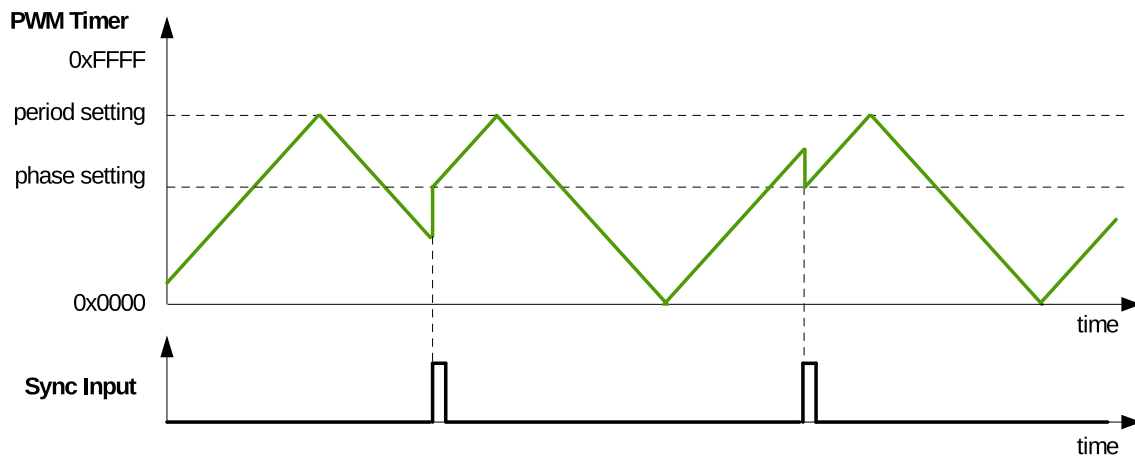

Figure 35-11. Count-Up-Down Mode Waveforms, Count-Up at Synchronization Event

When the PWM timer is running, it generates the following timing events periodically and automatically:

- UTEP: The timing event generated when the PWM timer's value is equal to the value of the period field (`MCPWM_TIMERx_PERIOD`) and when the PWM timer is increasing.
- UTEZ: The timing event generated when the PWM timer's value equals to zero and when the PWM timer is increasing.
- DTEP: The timing event generated when the PWM timer's value equals to the value of the period field (`MCPWM_TIMERx_PERIOD`) and when the PWM timer is decreasing.
- DTEZ: The timing event generated when the PWM timer's value equals to zero and when the PWM timer is decreasing.

Figures 35-12 to 35-14 show the timing waveforms of U/DTEP and U/DTEZ.

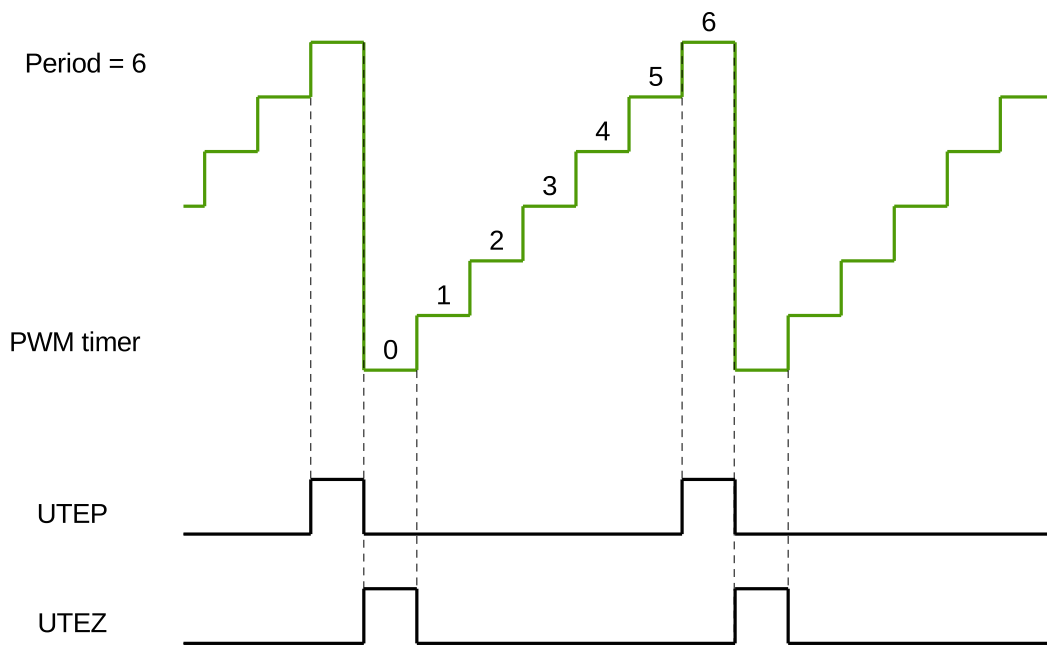

Figure 35-12. UTEP and UTEZ Generation in Count-Up Mode

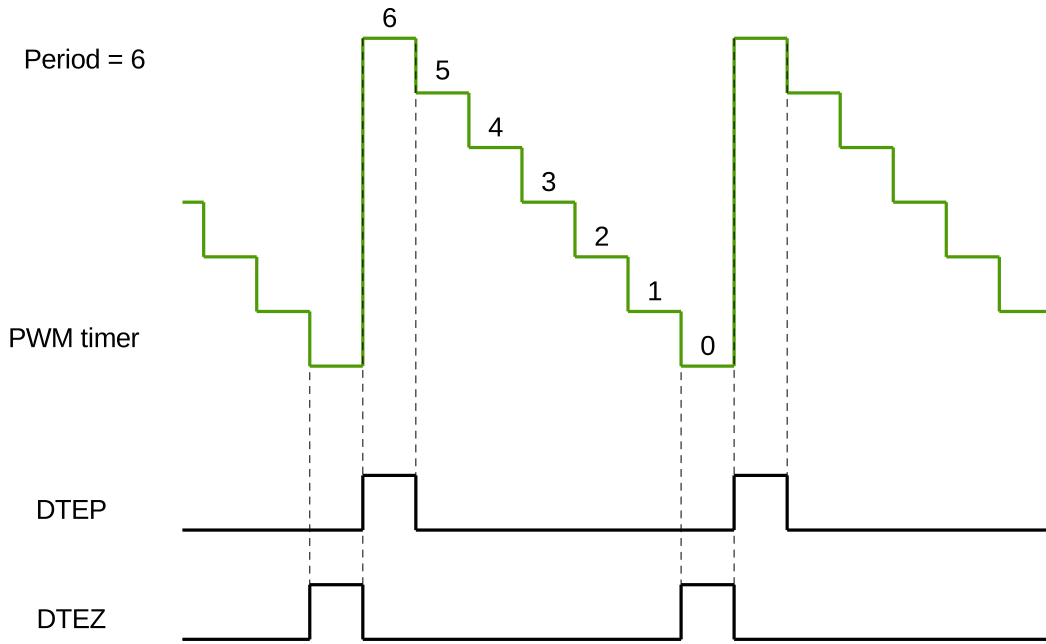

Figure 35-13. DTEP and DTEZ Generation in Count-Down Mode

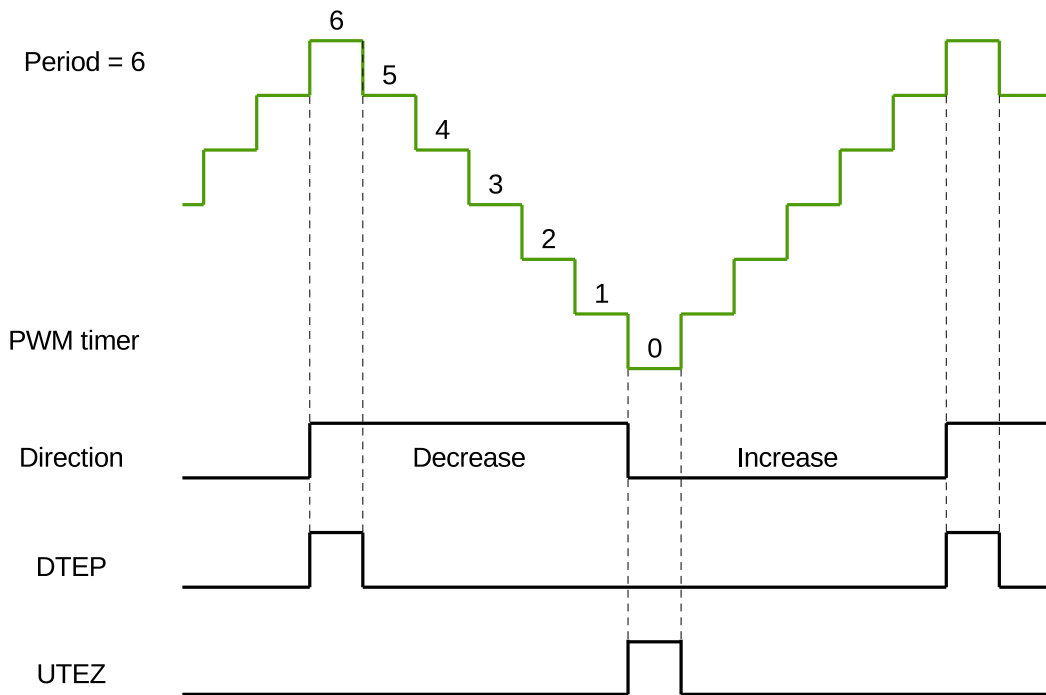

Figure 35-14. DTEP and UTEZ Generation in Count-Up-Down Mode

35.3.2.3 Shadow Register of PWM Timer

The PWM timer's period register and the PWM timer's clock prescaler register have shadow registers. The shadow registers can back up the values that are about to be written to the valid registers. It also supports to write the values saved into the active register at a specific moment of hardware synchronization. The functionality of both register types is as follows:

- Active Register: Directly responsible for controlling all actions performed by hardware.
- Shadow Register: Acts as a temporary buffer for a value to be written to the active register. At a specific, user-configured point in time, the value saved in the shadow register is copied to the active register. Before this happens, the content of the shadow register has no direct effect on the controlled hardware. This helps to prevent erroneous operation of the hardware, which may happen when a register is asynchronously modified by software. Both the shadow register and the active register have the same memory address. The software always writes into, or reads from the shadow register.

The moment of updating the clock prescaler's active register is at the time when the timer starts operating. When `MCPWM_GLOBAL_UP_EN` is set to 1, the moment of updating the period active register can be selected by the following ways:

- By configuring the update method register `MCPWM_TIMERx_PERIOD_UPMETHOD` to 0, the update will start immediately.
- By configuring the update method register `MCPWM_TIMERx_PERIOD_UPMETHOD` to 1, the update can start when the PWM timer is equal to zero.
- By configuring the update method register `MCPWM_TIMERx_PERIOD_UPMETHOD` to 2, the update can start when the PWM timer is synchronized.
- By configuring the update method register `MCPWM_TIMERx_PERIOD_UPMETHOD` to 3, the update can start when the PWM timer is equal to zero or is synchronized.
- Software can also trigger a globally forced update bit `MCPWM_GLOBAL_FORCE_UP` which will prompt all registers in the module to be updated according to shadow registers.

35.3.2.4 PWM Timer Synchronization and Phase Locking

The PWM modules adopt a flexible synchronization method. Each PWM timer has a synchronization input and a synchronization output. The synchronization input can be selected from three synchronization outputs and three synchronization signals from the GPIO matrix. The synchronization output can be generated from the synchronization input signal, when the PWM timer's value is equal to period or zero, or software synchronization. Thus, the PWM timers can be chained together with their phase locked. During synchronization, the PWM timer clock prescaler will reset its counter in order to synchronize the PWM timer clock.

35.3.3 PWM Operator Module

The PWM Operator module has the following functions:

- Generates a PWM signal pair, based on timing references obtained from the corresponding PWM timer.
- Each signal out of the PWM signal pair includes a specific pattern of dead time.
- Superimposes a carrier on the PWM signal, if configured to do so.

- Handles response under fault conditions.

Figure 35-15 shows the block diagram of a PWM operator.

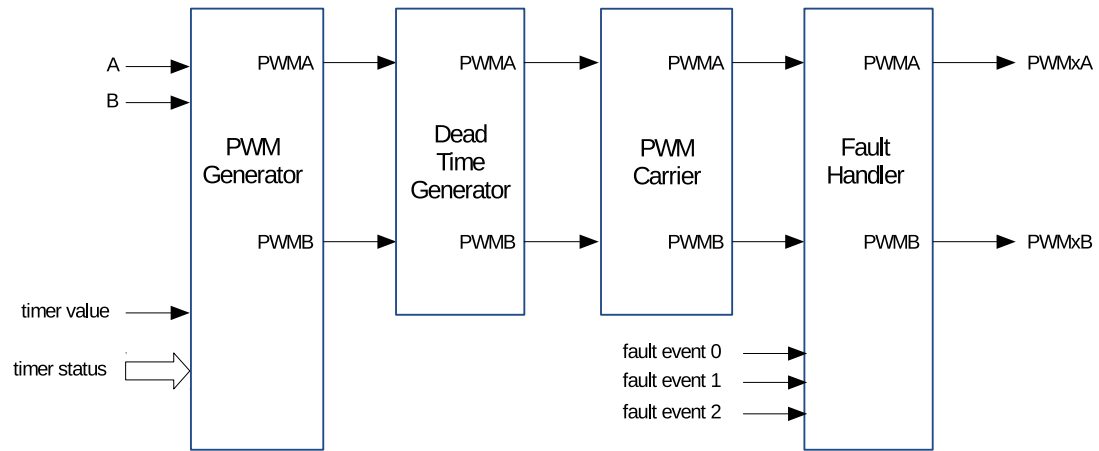

Figure 35-15. Block Diagram of A PWM Operator

35.3.3.1 PWM Generator Module

Purpose of the PWM Generator Module

In this module, important timing events are generated or imported. The events are then converted into specific actions to generate the desired waveforms at the PWMxA and PWMxB outputs.

The PWM generator module performs the following actions:

- Generation of timing events based on time stamps configured using the A and B registers. Events happen when the following conditions are met:
 - UTEA: the PWM timer is counting up and its value is equal to register A.
 - UTEB: the PWM timer is counting up and its value is equal to register B.
 - DTEA: the PWM timer is counting down and its value is equal to register A.
 - DTEB: the PWM timer is counting down and its value is equal to register B.
- Generation of U/DT0, U/DT1 timing events based on fault or synchronization events.
 - UT0: the PWM timer is counting up and FAULT0 detected (field `MCPWM_GENx_TO_SEL` is set to 0) or FAULT1 detected (field `MCPWM_GENx_TO_SEL` is set to 1) or FAULT2 detected (field `MCPWM_GENx_TO_SEL` is set to 2) or synchronized (field `MCPWM_GENx_TO_SEL` is set to 3).
 - UT1: the PWM timer is counting up and FAULT0 detected (field `MCPWM_GENx_T1_SEL` is set to 0) or FAULT1 detected (field `MCPWM_GENx_T1_SEL` is set to 1) or FAULT2 detected (field `MCPWM_GENx_T1_SEL` is set to 2) or synchronized (field `MCPWM_GENx_T1_SEL` is set to 3).
 - DT0: the PWM timer is counting down and FAULT0 detected (field `MCPWM_GENx_TO_SEL` is set to 0) or FAULT1 detected (field `MCPWM_GENx_TO_SEL` is set to 1) or FAULT2 detected (field `MCPWM_GENx_TO_SEL` is set to 2) or synchronized (field `MCPWM_GENx_TO_SEL` is set to 3).
 - DT1: the PWM timer is counting down and FAULT0 detected (field `MCPWM_GENx_T1_SEL` is set to 0) or FAULT1 detected (field `MCPWM_GENx_T1_SEL` is set to 1) or FAULT2 detected (field `MCPWM_GENx_T1_SEL` is set to 2) or synchronized (field `MCPWM_GENx_T1_SEL` is set to 3).
- Management of priority when these timing events occur concurrently.
- Generation of set, clear, and toggle actions, based on the timing events.
- Controlling of the PWM duty cycle, depending on configuration of the PWM generator module.
- Handling of new time stamp values, using shadow registers to prevent glitches in the PWM cycle.

Shadow Register of PWM Operator

The time stamp registers A and B, as well as action configuration registers `MCPWM_GENx_A_REG` and `MCPWM_GENx_B_REG` are shadowed. Shadowing provides a way of updating registers in sync with the hardware.

When `MCPWM_GLOBAL_UP_EN` is set to 1, the shadow registers can be written to the active register at a specified time. The update method field for `MCPWM_GENx_A_REG` and `MCPWM_GENx_B_REG` is `MCPWM_GENx_CFG_UPMETHOD`. Software can also trigger a globally forced update bit `MCPWM_GLOBAL_FORCE_UP` which will prompt all registers in the module to be updated according to shadow registers. For a description of the shadow registers, please see Section 35.3.2.3.

Timing Events

For convenience, all timing signals and events are summarized in Table 35-2.

Table 35-2. Timing Events Used in PWM Generator

Signal	Event Description	PWM Timer Operation
DTEP	PWM timer value is equal to the period register value	PWM timer counts down
DTEZ	PWM timer value is equal to zero	
DTEA	PWM timer value is equal to register A	
DTEB	PWM timer value is equal to register B	
DT0 event	Based on fault or synchronization events	
DT1 event	Based on fault or synchronization events	
UTEP	PWM timer value is equal to the period register value	PWM timer counts up
UTEZ	PWM timer value is equal to zero	
UTEA	PWM timer value is equal to register A	
UTEB	PWM timer value is equal to register B	
UT0 event	Based on fault or synchronization events	
UT1 event	Based on fault or synchronization events	
Software-force event	Software-initiated asynchronous event	N/A

The purpose of a software-force event is to impose non-continuous or continuous changes on the PWM_xA and PWM_xB outputs. The change is done asynchronously. Software-force control is handled by the MCPWM_GEN_x_FORCE_REG registers.

The selection and configuration of T0/T1 in the PWM generator module is independent of the configuration of fault events in the fault handler module. A particular trip event may or may not be configured to cause trip action in the fault handler submodule, but the same event can be used by the PWM generator to trigger T0/T1 for controlling PWM waveforms.

It is important to know that when the PWM timer is in count-up-down mode. It will always decrement after a TEP event, and increment after a TEZ event. So, when the PWM timer is in count-up-down mode, DTEP and UTEZ events will occur, while UTEP and DTEZ events never occurs.

The PWM generator can handle multiple events at the same time. Events are prioritized by the hardware and relevant details are provided in Table 35-3 and Table 35-4. Priority levels range from 1 (the highest) to 7 (the lowest). Please note that the priority of TEP and TEZ events depends on the PWM timer's counting mode.

If the value of A or B is set to be greater than the period, then U/DTEA and U/DTEB will never occur.

Table 35-3. Timing Events Priority When PWM Timer Increments

Priority Level	Event
1 (highest)	Software-forced event
2	UTEP
3	UT0
4	UT1
5	UTEB
6	UTEA

Priority Level	Event
7 (lowest)	UTEZ

Table 35-4. Timing Events Priority when PWM Timer Decrements

Priority level	Event
1 (highest)	Software-forced event
2	DTEZ
3	DT0
4	DT1
5	DTEB
6	DTEA
7 (lowest)	DTEP

Notes:

1. UTEP and UTEZ do not happen simultaneously. When the PWM timer is in count-up mode, UTEP will always happen one cycle earlier than UTEZ, as demonstrated in Figure 35-12, so their action on PWM signals will not interrupt each other. When the PWM timer is in count-up-down mode, UTEP will not occur.
2. DTEP and DTEZ do not happen simultaneously. When the PWM timer is in count-down mode, DTEZ will always happen one cycle earlier than DTEP, as demonstrated in Figure 35-13, so their action on PWM signals will not interrupt each other. When the PWM timer is in count-up-down mode, DTEZ will not occur.

PWM Signal Generation

The PWM generator module controls the behavior of outputting PWM_xA and PWM_xB when a particular timing event occurs. The timing events are further qualified by the PWM timer's counting mode (increment or decrement). Knowing the counting mode, the module may then perform an independent action at each stage of the PWM timer counting up or down.

The following actions may be configured on PWM_xA and PWM_xB outputs:

- Set High: Set the output of PWM_xA or PWM_xB to a high level.
- Clear Low: Clear the output of PWM_xA or PWM_xB by setting it to a low level.
- Toggle: Change the current output level of PWM_xA or PWM_xB to the opposite value. If it is currently pulled up, then pull it down, or vice versa.
- Do Nothing: Keep both outputs PWM_xA and PWM_xB unchanged. In this state, interrupts can still be triggered.

Actions on outputs is configured by using registers [MCPWM_GEN_x_A_REG](#) and [MCPWM_GEN_x_B_REG](#). So, the action to be taken on each output is set independently. Also there is great flexibility in selecting actions to be taken on a given output based on events. More specifically, any event listed in Table 35-2 can operate on either output of PWM_xA or PWM_xB. To check out registers for particular generator 0, 1, or 2, please refer to register description in Section 35.4.

Waveforms for Common Configurations

Figure 35-16 presents the symmetric PWM waveform generated when the PWM timer is in Count-Up-Down mode. DC 0%–100% modulation can be calculated via the formula below:

$$Duty = (Period - A) \div Period$$

If A matches the PWM timer value and the PWM timer is incrementing, then the PWM output is pulled up. If A matches the PWM timer value while the PWM timer is decrementing, then the PWM output is pulled low.

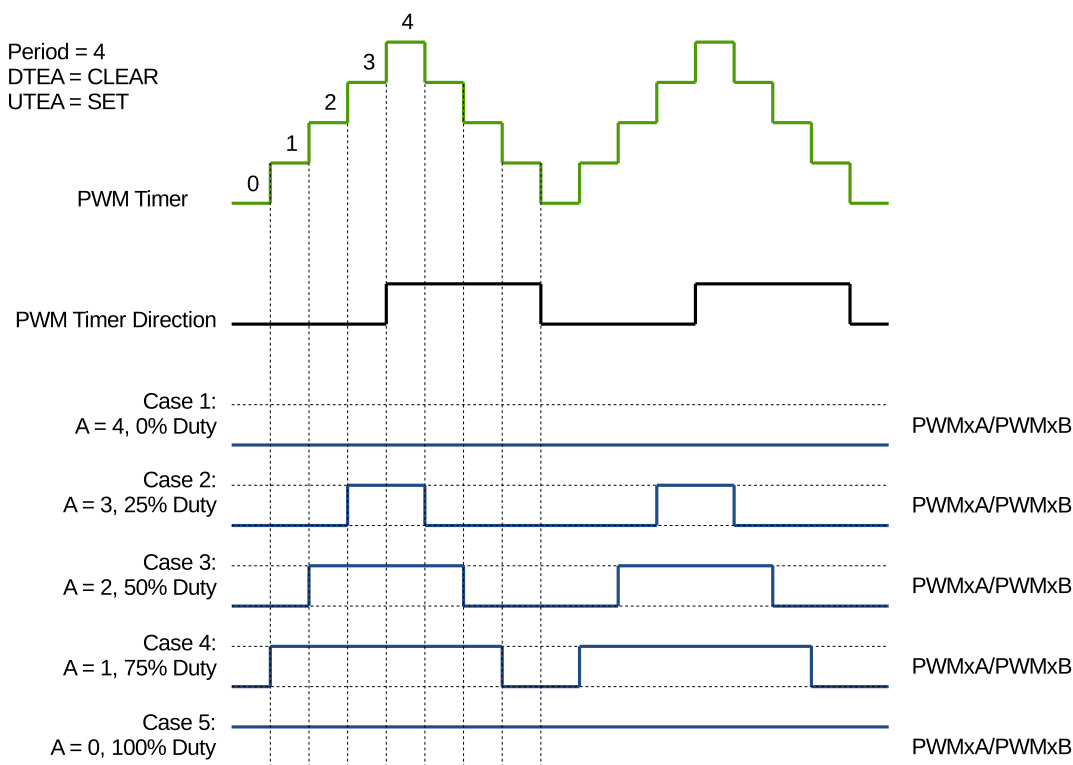

Figure 35-16. Symmetrical Waveform in Count-Up-Down Mode

The PWM waveforms in Figures 35-17 to 35-20 show some common PWM operator configurations. The following conventions are used in the figures:

- Period A and B refer to the values written in the corresponding registers.
- PWMxA and PWMxB are the output signals of PWM Operator x.

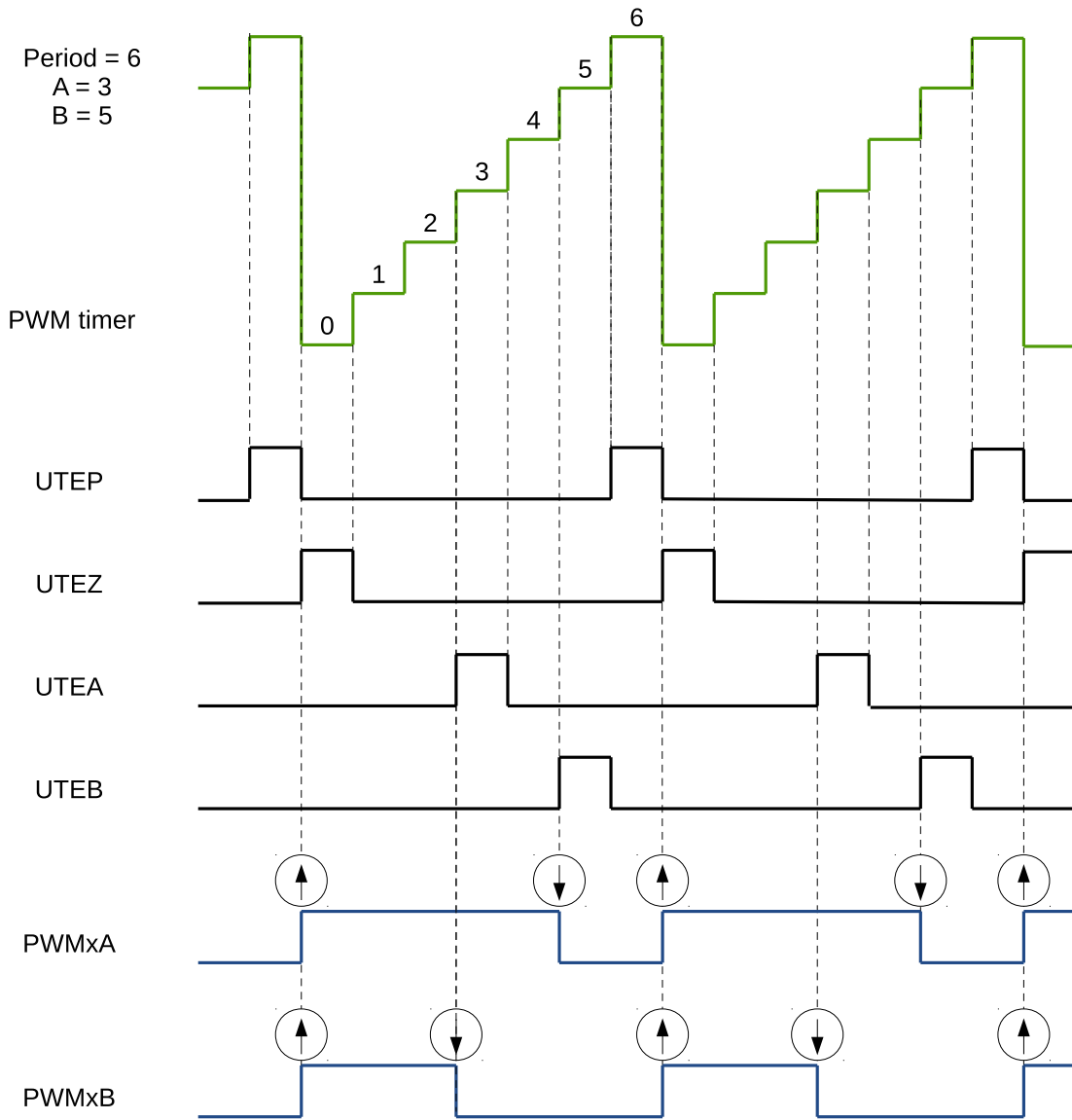

Figure 35-17. Count-Up, Single Edge Asymmetric Waveform, with Independent Modulation on PWMxA and PWMxB – Active High

The duty modulation for PWMxA is set by B, active high and proportional to B.

The duty modulation for PWMxB is set by A, active high and proportional to A.

$$Period = (MCPWM_TIMER_PERIOD + 1) \times T_{PT_clk}$$

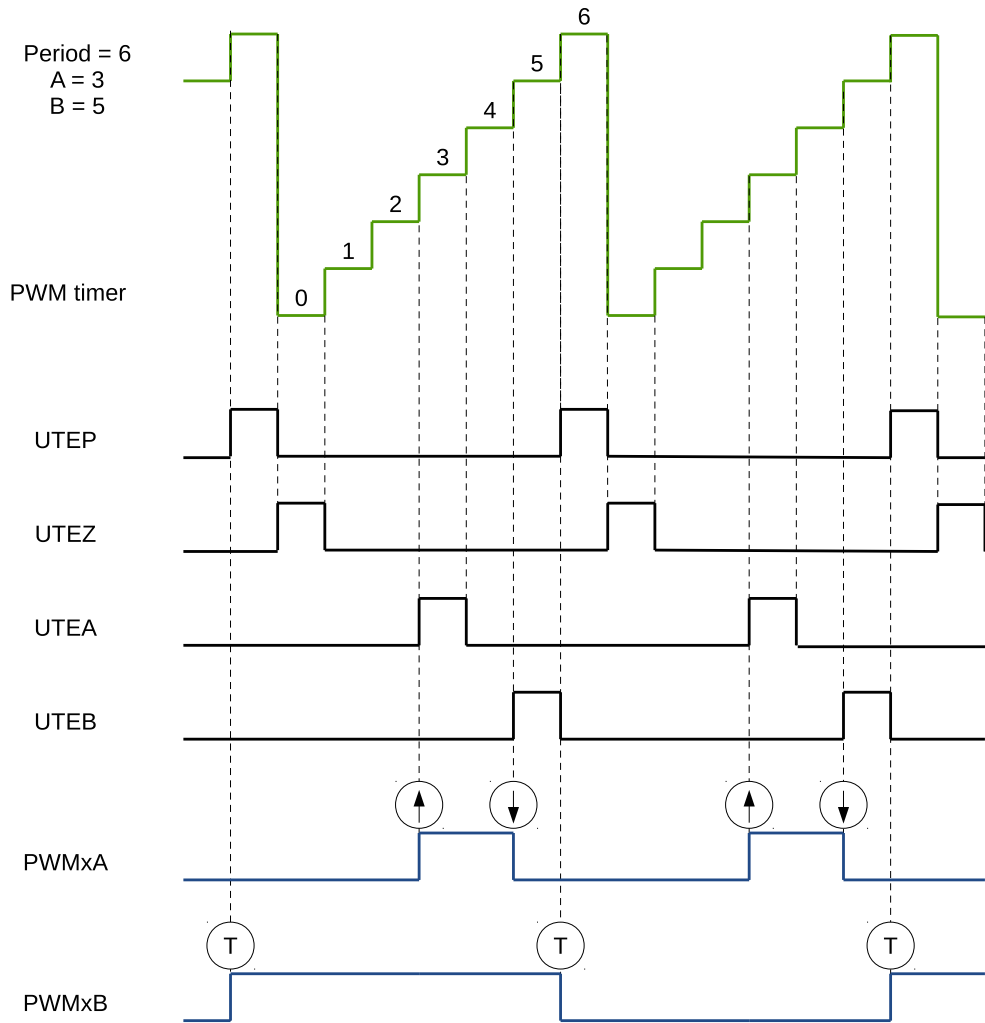

Figure 35-18. Count-Up, Pulse Placement Asymmetric Waveform with Independent Modulation on PWMxA

Pulses may be generated anywhere within the PWM cycle (zero to period).

PWMxA's high time duty is proportional to (B – A).

$$Period = (MCPWM_TIMER_PERIOD + 1) \times T_{PT_clk}$$

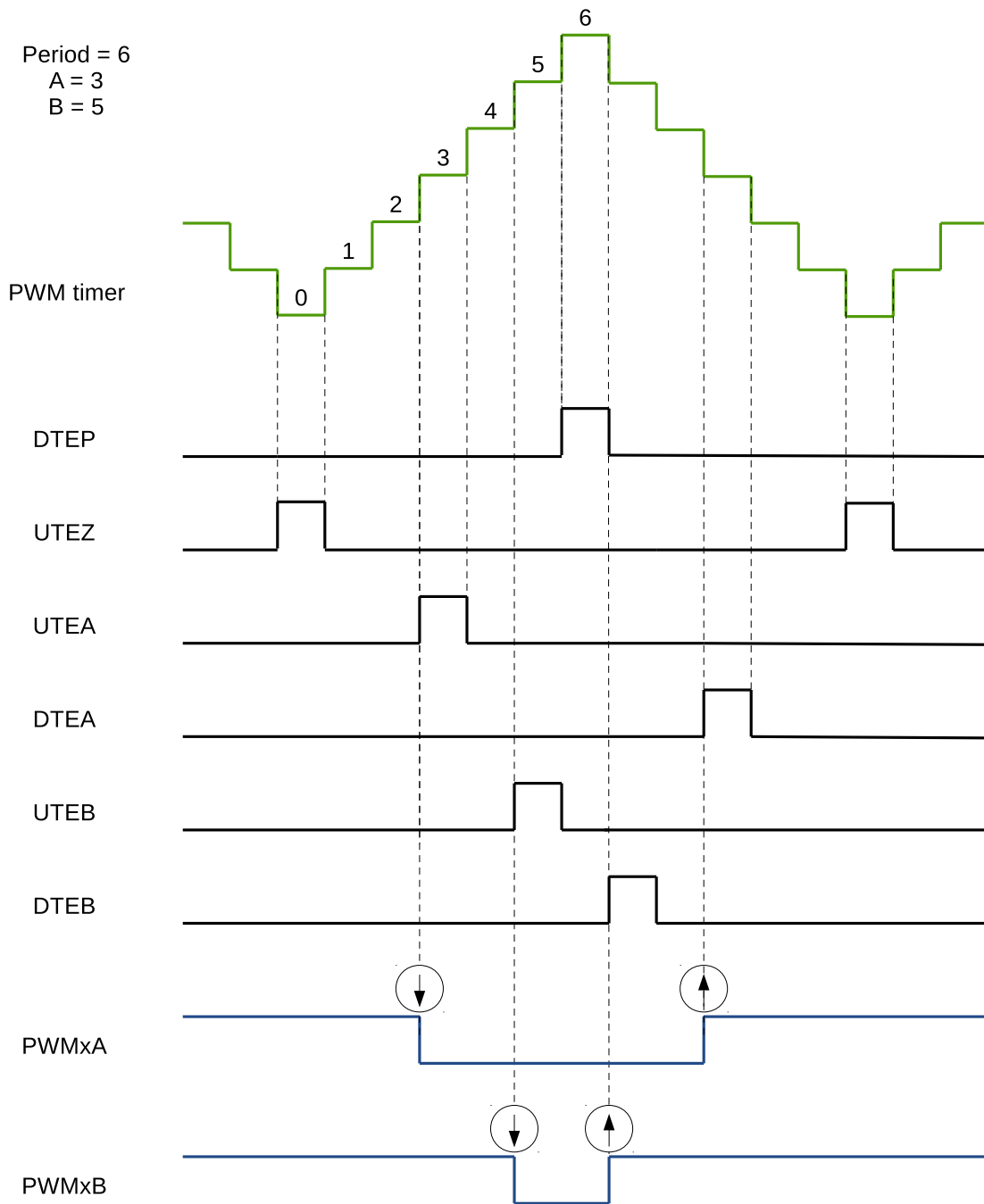

Figure 35-19. Count-Up-Down, Dual Edge Symmetric Waveform, with Independent Modulation on PWMxA and PWMxB – Active High

The duty modulation for PWMxA is set by A, active high and proportional to A.
The duty modulation for PWMxB is set by B, active high and proportional to B.
Outputting PWMxA and PWMxB can drive separate switches.

$$Period = (2 \times MCPWM_TIMER_PERIOD) \times T_{PT_clk}$$

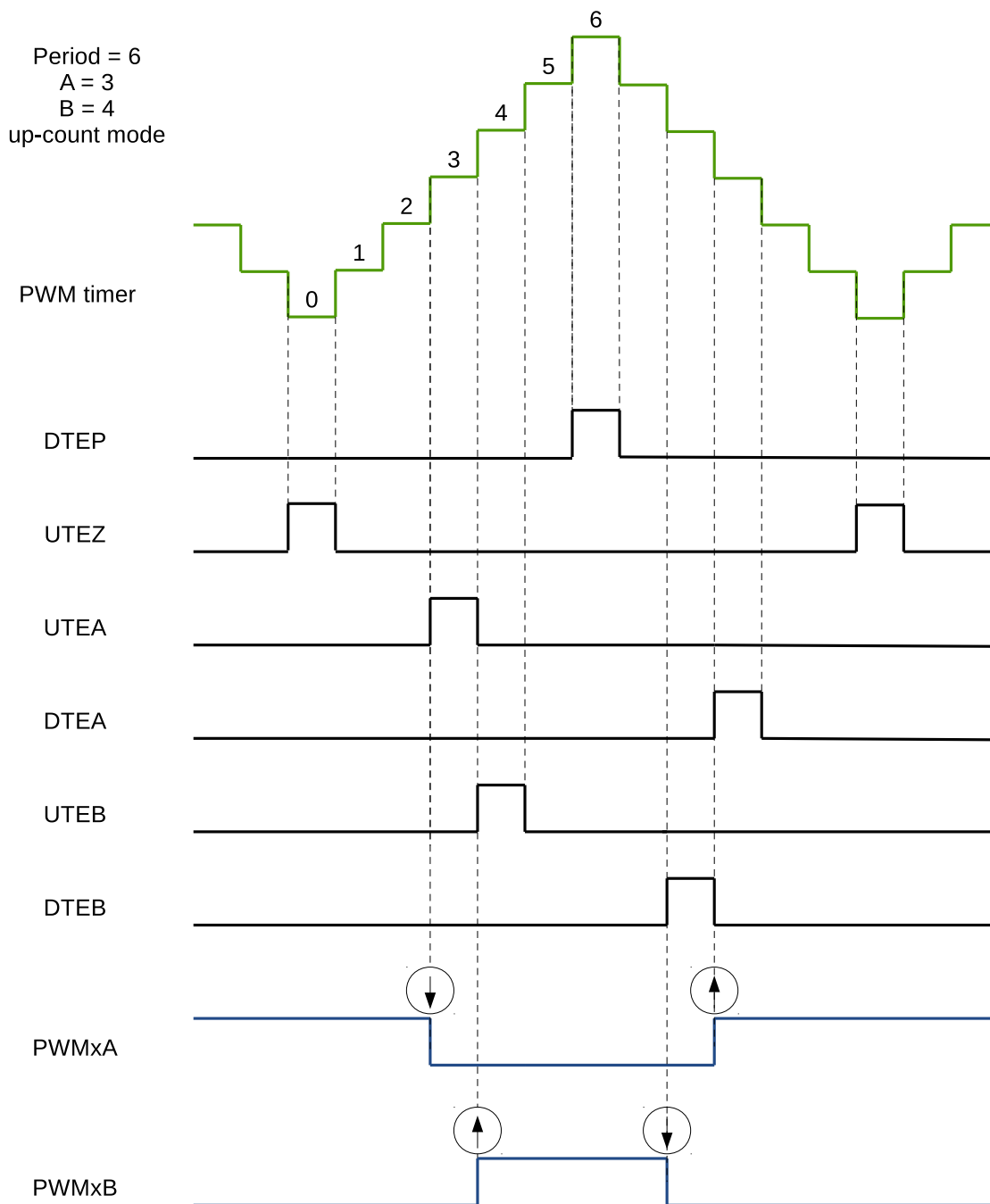

Figure 35-20. Count-Up-Down, Dual Edge Symmetric Waveform, with Independent Modulation on PWMxA and PWMxB – Complementary

The duty modulation of PWMxA is set by A, is active high and proportional to A.

The duty modulation of PWMxB is set by B, is active low and proportional to B.

Outputs PWMx can drive upper/lower (complementary) switches.

Dead time = B – A. Edge placement is configurable by software. Dead time generator module supports configuring edge delay methods when required.

$$Period = (2 \times MCPWM_TIMERx_PERIOD) \times T_{PT_clk}$$

Figure 35-21 shows a waveform when UT0/1 and DT0/1 events are generated. In this example, T0 selects

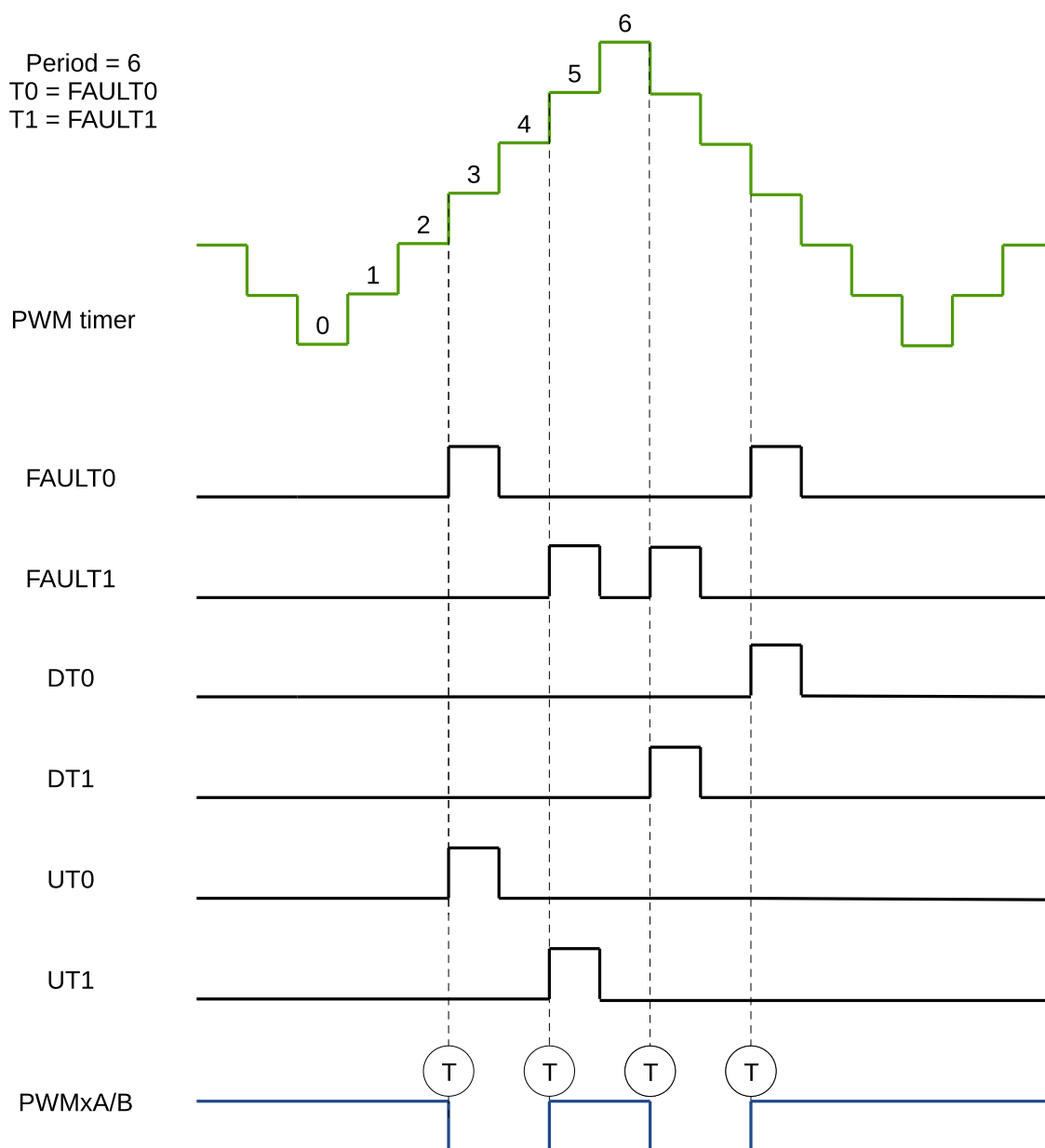

Figure 35-21. Count-Up-Down, Fault or Synchronization Events, with Same Modulation on PWMxA and PWMxB

FAULT0 and T1 selects FAULT1. The events selected by T0 and T1 can be configured independently, these events can be FAULT0, FAULT1, FAULT2 or synchronous. For detailed configuration, see section 35.3.3.1.

Software-Force Events

There are two types of software-force events inside the PWM generator:

- Non-continuous-immediate (NCI) software-force events: Such types of events are immediately effective on PWM outputs when triggered by software. The forcing is non-continuous, which means the next active timing events will be able to alter the PWM outputs.
- Continuous (CNTU) software-force events: Such types of events are continuous. The forced PWM outputs will continue until they are released by software. The events' triggers are configurable. They can be configured to be timing events or immediate events.

Figure 35-22 shows a waveform of NCI software-force events. NCI events are used to force PWMxA output low. Forcing on PWMxB is disabled in this case.

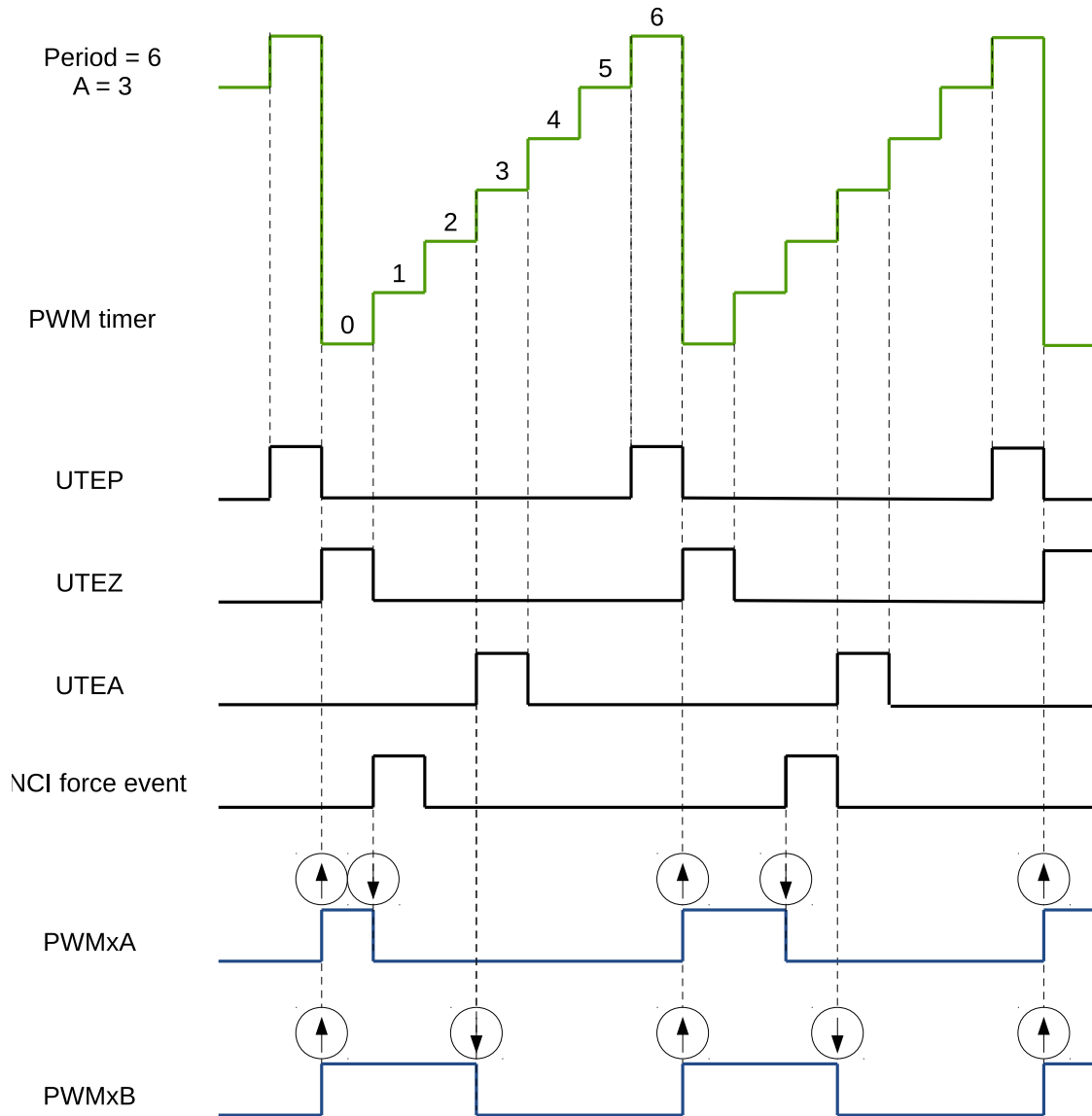

Figure 35-22. Example of an NCI Software-Force Event on PWMxA

Figure 35-23 shows a waveform of CNTU software-force events. UTEZ events are selected as triggers for CNTU software-force events. CNTU is used to force the PWMxB output low. Forcing on PWMxA is disabled.

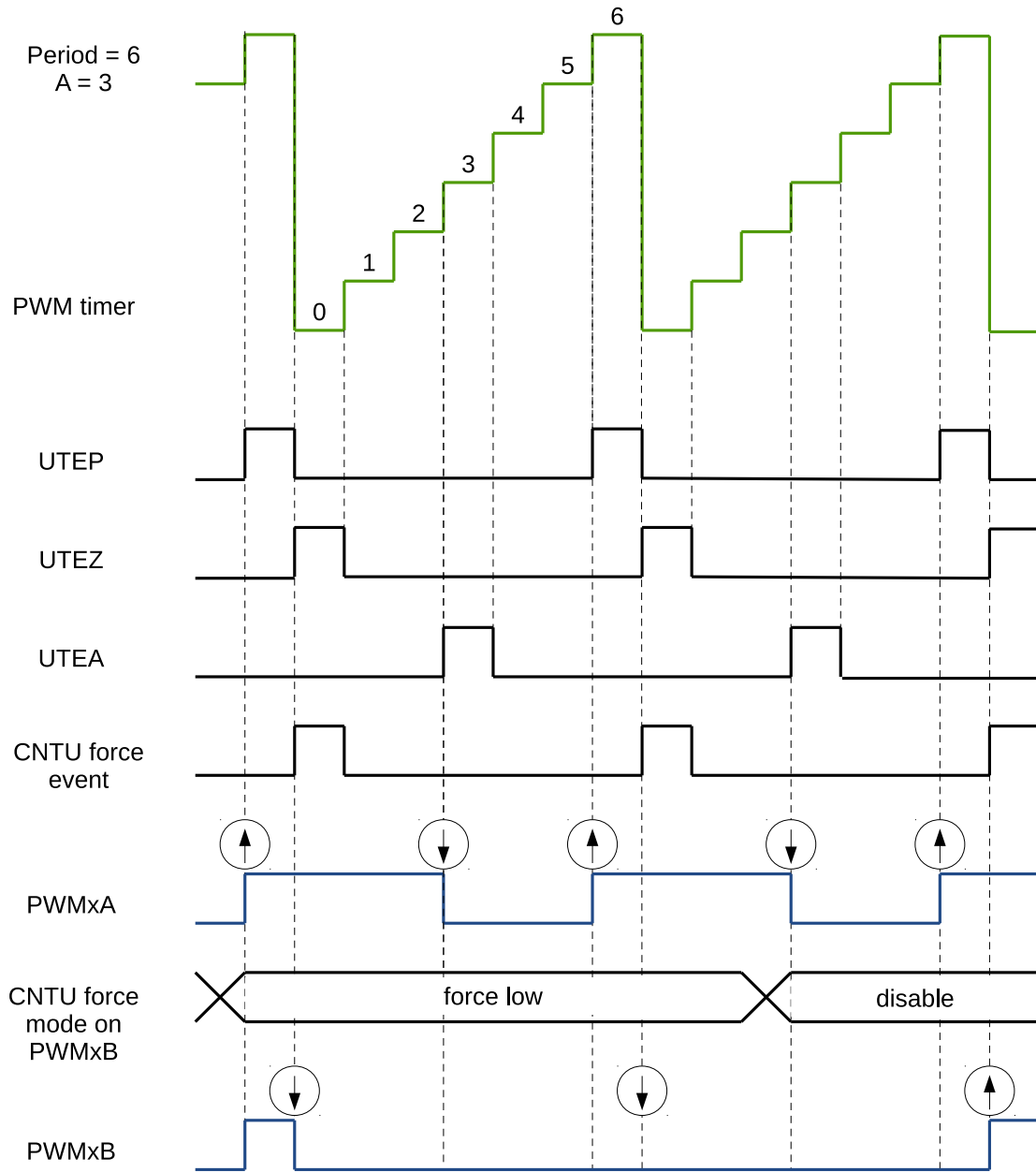

Figure 35-23. Example of a CNTU Software-Force Event on PWMxB

35.3.3.2 Dead Time Generator Module

Purpose of the Dead Time Generator Module

Section 35.3.3.1 introduced several options to generate signals on PWMxA and PWMxB outputs, with a specific placement of signal edges. The required dead time is obtained by altering the edge placement between signals and by setting the signal's duty cycle. Another option to control the dead time is to use a specialized module – Dead Time Generator.

The key functions of the Dead Time Generator module are as follows:

- Generating signal pairs (PWMxA and PWMxB) with a dead time from a single PWMxA input
- Creating a dead time by adding delay to signal edges:
 - Rising edge delay (RED)
 - Falling edge delay (FED)
- Configuring the signal pairs to be:
 - Active high complementary (AHC)
 - Active low complementary (ALC)
 - Active high (AH)
 - Active low (AL)
- This module may also be bypassed, if the dead time is configured directly in the generator module.

Shadow Register of Dead Time Generator

Delay registers RED and FED are shadowed with registers [MCPWM_DT_x_RED_CFG_REG](#) and [MCPWM_DT_x_FED_CFG_REG](#). When [MCPWM_GLOBAL_UP_EN](#) is set to 1, the values saved in the shadow registers can be written to the active register at specified time. The update method register for [MCPWM_DT_x_RED_CFG_REG](#) is [MCPWM_DT_x_RED_UPMETHOD](#). The update method register for [MCPWM_DT_x_FED_CFG_REG](#) is [MCPWM_DT_x_FED_UPMETHOD](#). The Software can also trigger a globally forced update bit [MCPWM_GLOBAL_FORCE_UP](#) which will prompt all registers in the module to be updated according to shadow registers. For the description of shadow registers, please see section 35.3.2.3.

Highlights for Operation of the Dead Time Generator

Options for setting up the dead time module are shown in Figure 35-24.

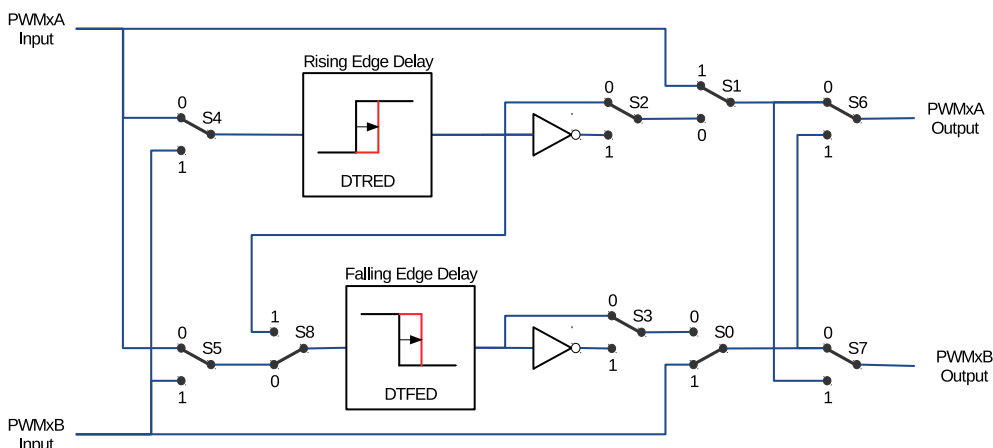

Figure 35-24. Options for Setting up the Dead Time Generator Module

S0-S8 in the figure above are switches controlled by fields in register MCPWM_DT_x_CFG_REG shown in Table 35-5.

Table 35-5. Dead Time Generator Switches Control Fields

Switch	Field
S0	MCPWM_DT _x _B_OUTBYPASS
S1	MCPWM_DT _x _A_OUTBYPASS
S2	MCPWM_DT _x _RED_OUTINVERT
S3	MCPWM_DT _x _FED_OUTINVERT
S4	MCPWM_DT _x _RED_INSEL
S5	MCPWM_DT _x _FED_INSEL
S6	MCPWM_DT _x _A_OUTSWAP
S7	MCPWM_DT _x _B_OUTSWAP
S8	MCPWM_DT _x _DEB_MODE

All switch combinations are supported, but not all of them represent the typical modes of use. Table 35-6 documents some typical dead time configurations. In these configurations, the position of S4 and S5 sets PWMxA as the common source of both falling edge delay (FED) and rising edge delay (RED). The modes presented in table 35-6 may be categorized as follows:

Table 35-6. Typical Dead Time Generator Operating Modes

Mode	Mode Description	S0	S1	S2	S3
1	PWMxA and PWMxB Pass Through/No Delay	1	1	X	X
2	Active High Complementary (AHC), see Figure 35-25	0	0	0	1
3	Active Low Complementary (ALC), see Figure 35-26	0	0	1	0
4	Active High (AH), see Figure 35-27	0	0	0	0
5	Active Low (AL), see Figure 35-28	0	0	1	1

Mode	Mode Description	S0	S1	S2	S3
6	PWMxA Output = PWMxA In (No Delay) PWMxB Output = PWMxA Input with Falling Edge Delay	0	1	0 or 1	0 or 1
7	PWMxA Output = PWMxA Input with Rising Edge Delay PWMxB Output = PWMxB Input with No Delay	1	0	0 or 1	0 or 1

Note:

For all the modes above, the position of the binary switches S4 to S8 is set to 0.

- **Mode 1: Bypass delays on both FED and RED**

In this mode, the dead time module is disabled. Signals of PWMxA and PWMxB pass through without any modifications.

- **Mode 2-5: Classical Dead Time Polarity Settings**

These four modes represent typical configurations of polarity and should cover the active-high/low modes in available industry power switch gate drivers. The typical waveforms are shown in Figures 35-25 to 35-28.

- **Modes 6 and 7: Bypass delay on falling edge (FED) or rising edge (RED)**

In these two modes, either RED or FED is bypassed. As a result, the corresponding delay is not applied.

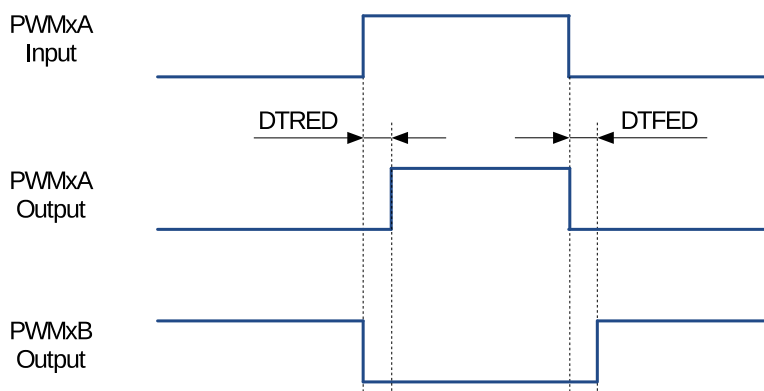

Figure 35-25. Active High Complementary (AHC) Dead Time Waveforms

RED and FED delays may be set up independently. The delay value is programmed using the 16-bit field `MCPWM_DTx_RED` and `MCPWM_DTx_FED`. The register value represents the number of clock (`DT_CLK`) periods by which a signal edge is delayed. `DT_CLK` can be selected from `PWM_clk` or `PT_clk` through register `MCPWM_DTx_CLK_SEL`.

To calculate the delay on falling edge (FED) and rising edge (RED), use the following formulas:

$$FED = MCPWM_DT_x_FED \times T_{DT_clk}$$

$$RED = MCPWM_DT_x_RED \times T_{DT_clk}$$

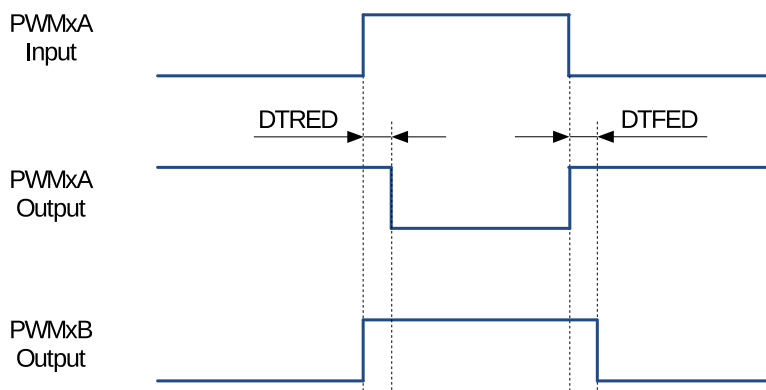

Figure 35-26. Active Low Complementary (ALC) Dead Time Waveforms

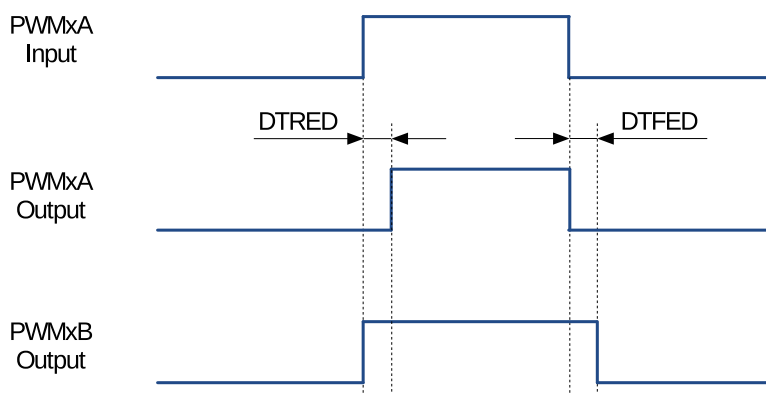

Figure 35-27. Active High (AH) Dead Time Waveforms

35.3.3.3 PWM Carrier Module

The coupling of PWM output to a motor driver may need isolation with a transformer. Transformers deliver only AC signals, while the duty cycle of a PWM signal may range anywhere from 0% to 100%. The PWM carrier module passes such a PWM signal through a transformer by using a high frequency carrier to modulate the signal.

Function Overview

The following key characteristics of this module are configurable:

- Carrier frequency
- Pulse width of the first pulse
- Duty cycle of the second and the subsequent pulses
- Enabling/disabling the carrier function

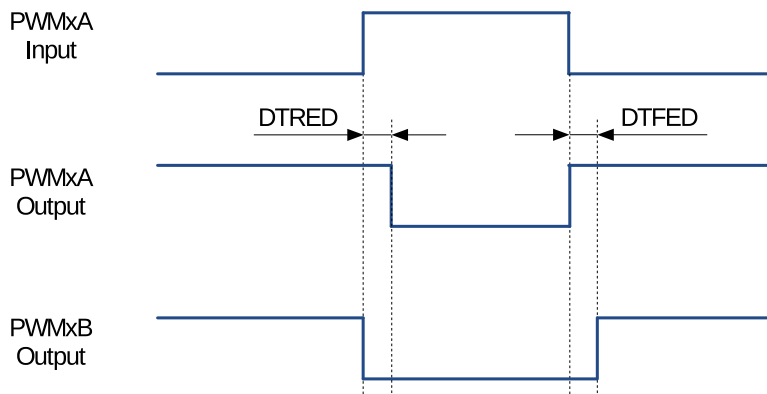

Figure 35-28. Active Low (AL) Dead Time Waveforms

Operational Highlights

The PWM carrier clock (PC_clk) is derived from PWM_clk. The frequency and duty cycle are configured by the MCPWM_CARRIERx_PRESCALE and MCPWM_CARRIERx_DUTY bits in the MCPWM_CARRIERx_CFG_REG register. The purpose of one-shot pulses is to provide high-energy impulse to reliably turn on the power switch. Subsequent pulses sustain the power-on status. The width of a one-shot pulse is configurable with the MCPWM_CARRIERx_OSHTWTH field. Enabling/disabling of the carrier module is done with the MCPWM_CARRIERx_EN bit.

Waveform Examples

Figure 35-29 shows an example of waveforms, where a carrier is superimposed on original PWM pulses. This figure do not show the first one-shot pulse and the duty-cycle control. Related details are covered in the following two sections.

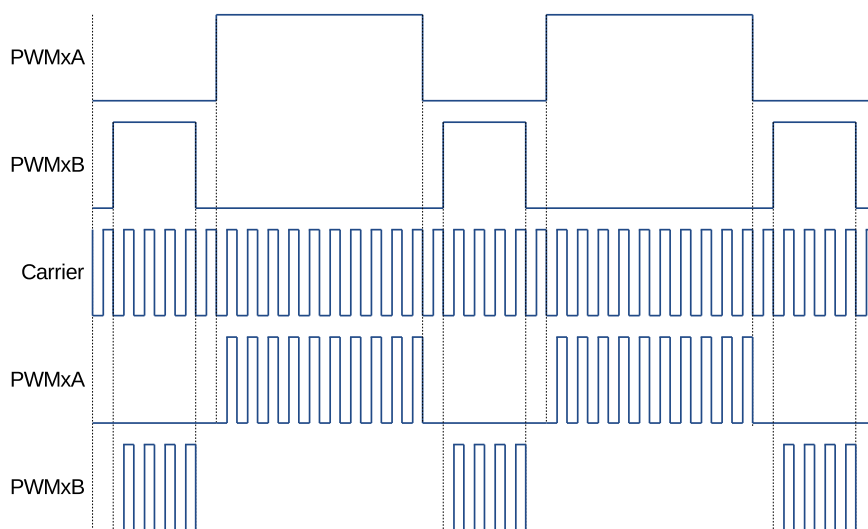

Figure 35-29. Example of Waveforms Showing PWM Carrier Action

One-Shot Pulse

The width of the first pulse can be configured to 16 different values, which can be calculated by the following equation:

$$T_{1stpulse} = T_{PWM_clk} \times 8 \times (MCPWM_CARRIER_PRESCALE + 1) \times (MCPWM_CARRIER_OSHTWTH + 1)$$

Where:

- T_{PWM_clk} is the period of the PWM clock (PWM_clk).
- $(MCPWM_CARRIER_OSHTWTH + 1)$ is the width of the first pulse (whose value ranges from 1 to 16).
- $(MCPWM_CARRIER_PRESCALE + 1)$ is the PWM carrier clock's (PC_clk) prescaler value.

The first one-shot pulse and subsequent sustaining pulses are shown in Figure 35-30.

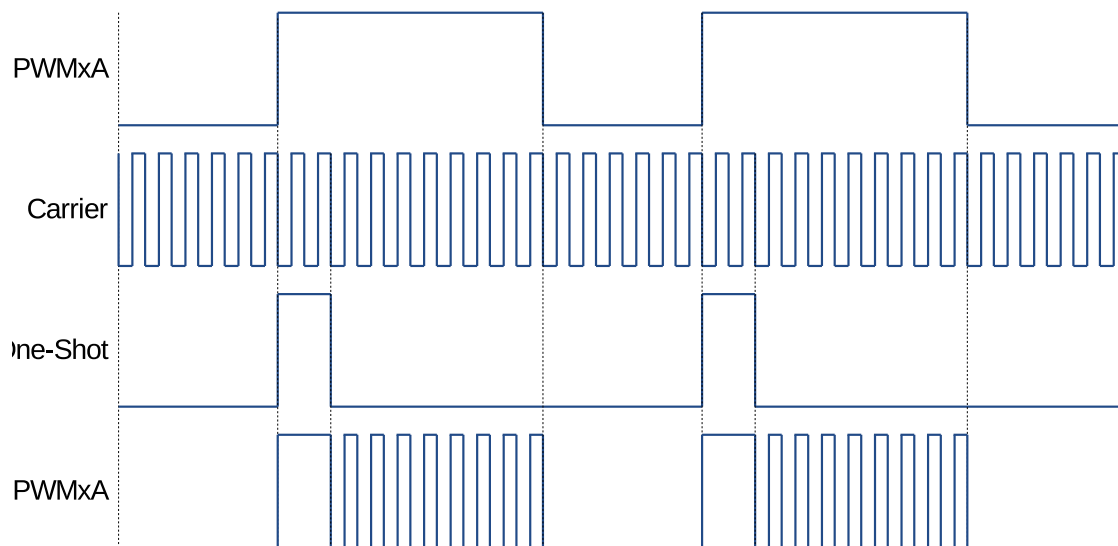

Figure 35-30. Example of the First Pulse and the Subsequent Sustaining Pulses of the PWM Carrier Submodule

Duty Cycle Control

After issuing the first one-shot pulse, the remaining PWM signal is modulated according to the carrier frequency. Users can configure the duty cycle of this signal. Tuning of duty may be required, so that the signal passes through the isolating transformer and can still operate (turn on/off) the motor drive, changing rotation speed and direction.

The duty cycle may be set to one of seven values, using `MCPWM_CARRIER_DUTY`, or bits [7:5] of register `MCPWM_CARRIER_CFG_REG`.

Below is the formula for calculating the duty cycle:

$$Duty = MCPWM_CARRIER_DUTY \div 8$$

All seven settings of the duty cycle are shown in Figure 35-31.

PRELIMINARY

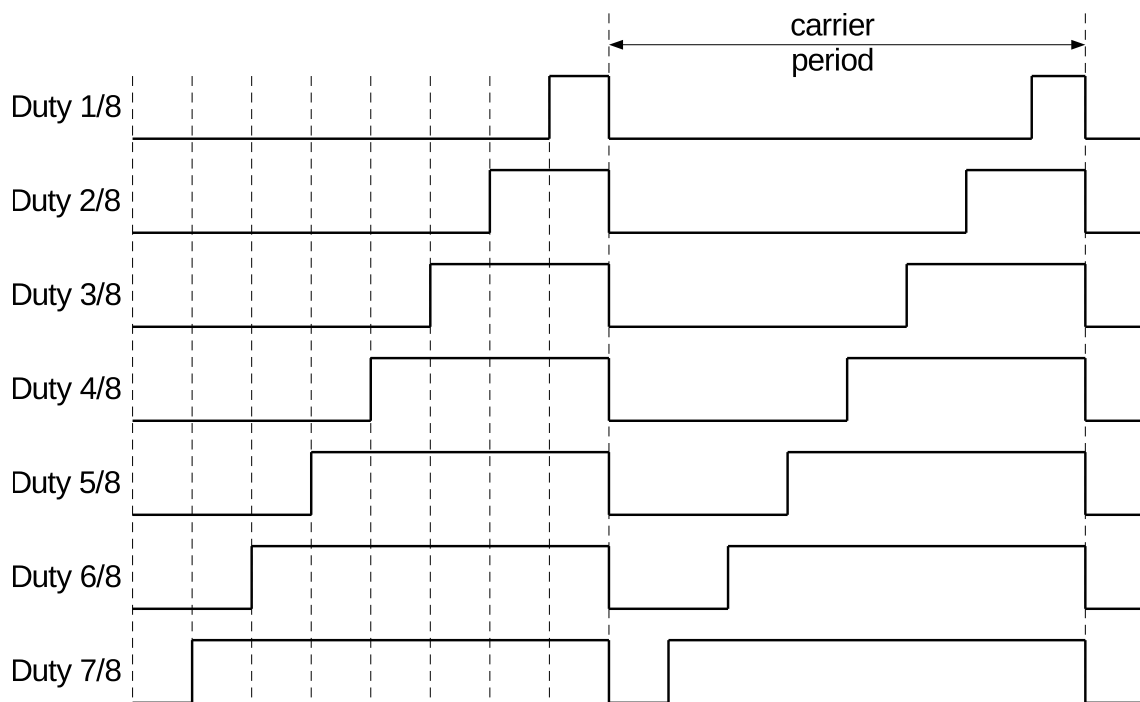

Figure 35-31. Possible Duty Cycle Settings for Sustaining Pulses in the PWM Carrier Submodule

35.3.3.4 Fault Detection Module

Each MCPWM peripheral is connected to three fault signals (FAULT0, FAULT1, and FAULT2) which are sourced from the GPIO matrix. These signals are intended to indicate external fault conditions, and may be preprocessed by the Fault Detection module to generate fault events. Fault events can then execute the user code to control MCPWM outputs in response to specific faults.

Function of Fault Detection Module

The key actions performed by the fault detection module are:

- Forcing outputs PWMxA and PWMxB, upon detected fault, to one of the following states:
 - High
 - Low
 - Toggle
 - No action taken
- Execution of one-shot trip (OST) upon detection of over-current conditions/short circuits.
- Cycle-by-cycle trip (CBC) to provide current-limiting operation.
- Allocation of either one-shot or cycle-by-cycle operation for each fault signal.
- Generation of interrupts for each fault input.
- Support for software-force tripping.
- Enabling or disabling of module function as required.

Operation and Configuration Tips

This section provides the operational tips and set-up options for the Fault Detection module.

Fault signals coming from pins are sampled and synced in the GPIO matrix. In order to guarantee the successful sampling of fault pulses, each pulse duration must be at least two APB clock cycles. The Fault Detection module will then sample fault signals by using PWM_clk. So, the duration of fault pulses coming from GPIO matrix must be at least one PWM_clk cycle. Differently put, regardless of the period relation between APB clock and PWM_clk, the width of fault signal pulses on pins must be at least equal to the sum of two APB clock cycles and one PWM_clk cycle.

Each level of fault signals, FAULT0 to FAULT2, can be used by the Fault Detection module to generate fault events (fault_event0 to fault_event2). Every fault event can be configured individually to provide CBC action, OST action, or none.

- **Cycle-by-Cycle (CBC) action:**

When CBC action is triggered, the state of PWMxA and PWMxB will be changed immediately according to the configuration of fields `MCPWM_FHx_A_CBC_U/D` and `MCPWM_FHx_B_CBC_U/D`. Different actions can be indicated when the PWM timer is incrementing or decrementing. Different CBC action interrupts can be triggered for different fault events. Status field `MCPWM_FHx_CBC_ON` indicates whether a CBC action is on or off. When the fault event is no longer present, CBC actions on PWMxA/B will be cleared at a specified point, which is either a D/UTEP or D/UTEZ event. Field `MCPWM_FHx_CBCPULSE` determines at which event PWMxA and PWMxB will be able to resume normal actions. Therefore, in this mode, the CBC action is cleared or refreshed upon every PWM cycle.

- **One-Shot (OST) action:**

When OST action is triggered, the state of PWMxA and PWMxB will be changed immediately, depending on the setting of fields `MCPWM_FHx_A_OST_U/D` and `MCPWM_FHx_B_OST_U/D`. Different actions can be configured when PWM timer is incrementing or decrementing. Different OST action interrupts can be triggered from different fault events. Status field `MCPWM_FHx_OST_ON` indicates whether an OST action is on or off. The OST actions on PWMxA/B are not automatically cleared when the fault event is no longer present. One-shot actions must be cleared manually by setting the `MCPWM_FHx_CLR_OST` bit.

35.3.4 Capture Module

35.3.4.1 Introduction

The capture module contains three complete capture channels. Channel inputs CAP0, CAP1, and CAP2 are sourced from the GPIO matrix. Thanks to the flexibility of the GPIO matrix, CAP0, CAP1, and CAP2 can be configured from any pin input. Multiple capture channels can be sourced from the same pin input, while prescaling for each channel can be set differently. Also, capture channels are sourced from different pins. This provides several options for handling capture signals by hardware in the background, instead of having them processed directly by the CPU. A capture module has the following independent key resources:

- One 32-bit timer (counter) which can be synchronized with the PWM timer, another module, or software.
- Three capture channels, each equipped with a 32-bit time-stamp and a capture prescaler.
- Independent edge polarity (rising/falling edge) selection for any capture channel.
- Input capture signal prescaling (from 1 to 256).

- Interrupt capabilities on any of the three capture events.

35.3.4.2 Capture Timer

The capture timer is a 32-bit counter incrementing continuously. It is enabled by setting `MCPWM_CAP_TIMER_EN` to 1. Its operating clock source is MCPWM core clock. When `MCPWM_CAP_SYNCI_EN` is configured, the counter will be loaded with phase stored in register `MCPWM_CAP_TIMER_PHASE_REG` at the time of a sync event. Sync events can select from PWM timers sync-out, or PWM module sync-in by configuring `MCPWM_CAP_SYNCI_SEL`. Sync events can also be generated by setting `MCPWM_CAP_SYNC_SW`. The capture timer provides timing references for all three capture channels.

35.3.4.3 Capture Channel

The capture signal coming to a capture channel will be inverted first, if needed, and then prescaled. Each capture channel has a prescaler register of `MCPWM_CAPx_PRESCALE`. Finally, specified edges of preprocessed capture signal will trigger capture events. Setting `MCPWM_CAPx_EN` to enable a capture channel. The capture event occurs at the time selected by the `MCPWM_CAPx_MODE`. When a capture event occurs, the capture timer's value is stored in time-stamp register `MCPWM_CAP_CHx_REG`. Different interrupts can be generated for different capture channels at capture events. The edge that triggers a capture event is recorded in register `MCPWM_CAPx_EDGE`. The capture event can be also forced by software setting `MCPWM_CAPx_SW`.

35.3.5 ETM Module

35.3.5.1 Overview

The MCPWM peripheral on ESP32-C6 supports the Event Task Matrix (ETM) function, which allows MCPWM's ETM tasks to be triggered by any peripherals' ETM events, or MCPWM's ETM events to trigger any peripherals' ETM tasks. The capture module, the fault detection module, three timers, and three operators can generate events and respond to tasks independently. This section introduces the ETM tasks and events related to MCPWM. For more information, please refer to Chapter 11 [Event Task Matrix \(SOC_ETM\)](#).

35.3.5.2 MCPWM-Related ETM Events

When setting enable field to 1, after the generation condition is met, the corresponding event would be generated. For details, please refer to Table 35-7 below:

Table 35-7. MCPWM-Related ETM Events

Enable Field	Generation Condition	Event Generated
<code>MCPWM_EVT_CAPx_EN</code>	CAPx capture event occurs	<code>MCPWM_EVT_CAPx</code>
<code>MCPWM_EVT_TZx_OST_EN</code>	PWM operator x performs a One-Shot trip (OST) operation	<code>MCPWM_EVT_TZx_OST</code>
<code>MCPWM_EVT_TZx_CBC_EN</code>	PWM operator x performs a cycle-by-cycle trip (CBC) operation.	<code>MCPWM_EVT_TZx_CBC</code>
<code>MCPWM_EVT_Fx_CLR_EN</code>	fault event <code>fault_eventx</code> is cleared	<code>MCPWM_EVT_Fx_CLR</code>
<code>MCPWM_EVT_Fx_EN</code>	fault event <code>fault_eventx</code> is generated	<code>MCPWM_EVT_Fx</code>

¹ See Section 35.3.3.1 for a detailed description of timer stamp A and B.

Enable Field	Generation Condition	Event Generated
MCPWM_EVT_OP _x _TEB_EN	the count value of the timer that PWM operator <i>x</i> selects is equal to the value of timer stamp B ¹	MCPWM_EVT_OP _x _TEB
MCPWM_EVT_OP _x _TEA_EN	the count value of the timer that PWM operator <i>x</i> selects is equal to the value of timer stamp A ¹	MCPWM_EVT_OP _x _TEA
MCPWM_EVT_TIMER _x _TEP_EN	count value of timer <i>x</i> is equal to the period value MCPWM_TIMER _x _PERIOD	MCPWM_EVT_TIMER _x _TEP
MCPWM_EVT_TIMER _x _TEZ_EN	count value of timer <i>x</i> is equal to 0	MCPWM_EVT_TIMER _x _TEZ
MCPWM_EVT_TIMER _x _STOP_EN	timer <i>x</i> 's count stops	MCPWM_EVT_OP _x _TEA

¹ See Section 35.3.3.1 for a detailed description of timer stamp A and B.

35.3.5.3 MCPWM-Related ETM Tasks

When setting the enable field to 1, after inputting valid tasks, the corresponding response operation would be generated. For details, please refer to Table 35-8 below:

Table 35-8. ETM Related Tasks

Enable Field	Valid Task Input	Response Operation
MCPWM_TASK_CAP _x _EN	MCPWM_TASK_CAP _x	CAP _x channel performs a capture operation
MCPWM_TASK_CLR _x _OST_EN	MCPWM_TASK_CLR _x _OST	PWM operator <i>x</i> clears the One-Shot Trip operation
MCPWM_TASK_TZ _x _OST_EN	MCPWM_TASK_TZ _x _OST	PWM operator <i>x</i> performs a One-Shot Trip (OST) operation
MCPWM_TASK_TIMER _x _PERIOD_UP_EN	MCPWM_TASK_TIMER _x _PERIOD_UP	the period of timer <i>x</i> is updated to the value configured in the period register MCPWM_TIMER _x _PERIOD
MCPWM_TASK_TIMER _x _SYNC_EN	MCPWM_TASK_TIMER _x _SYN	timer <i>x</i> performs a sync operation
MCPWM_TASK_GEN_STOP_EN	MCPWM_TASK_GEN_STOP	all the timers stop counting and the PWM signals output by all PWM operators remain unchanged
MCPWM_TASK_CMPR _x _B_UP_EN	MCPWM_TASK_CMPR _x _B_UP	timer stamp B of the PWM operator <i>x</i> is updated to the value of the shadow register MCPWM_GEN _x _B
MCPWM_TASK_CMPR _x _A_UP_EN	MCPWM_TASK_CMPR _x _A_UP	timer stamp A of the PWM operator <i>x</i> is updated to the value of the shadow register MCPWM_GEN _x _A

35.4 Register Summary

The addresses in this section are relative to Motor Control PWM base address provided in Table 5-2 in Chapter 5 *System and Memory*.

The abbreviations given in Column **Access** are explained in Section *Access Types for Registers*.

Name	Description	Address	Access
Prescaler Configuration			
MCPWM_CLK_CFG_REG	PWM clock prescaler register	0x0000	R/W
MCPWM Timer 0 Configuration and Status			
MCPWM_TIMER0_CFG0_REG	PWM timer0 period and update method configuration register	0x0004	R/W
MCPWM_TIMER0_CFG1_REG	PWM timer0 working mode and start/stop control configuration register	0x0008	varies
MCPWM_TIMER0_SYNC_REG	PWM timer0 sync function configuration register	0x000C	R/W
MCPWM_TIMER0_STATUS_REG	PWM timer0 status register	0x0010	RO
MCPWM Timer 1 Configuration and Status			
MCPWM_TIMER1_CFG0_REG	PWM timer1 period and update method configuration register	0x0014	R/W
MCPWM_TIMER1_CFG1_REG	PWM timer1 working mode and start/stop control configuration register	0x0018	varies
MCPWM_TIMER1_SYNC_REG	PWM timer1 sync function configuration register	0x001C	R/W
MCPWM_TIMER1_STATUS_REG	PWM timer1 status register	0x0020	RO
MCPWM Timer 2 Configuration and status			
MCPWM_TIMER2_CFG0_REG	PWM timer2 period and update method configuration register	0x0024	R/W
MCPWM_TIMER2_CFG1_REG	PWM timer2 working mode and start/stop control configuration register	0x0028	varies
MCPWM_TIMER2_SYNC_REG	PWM timer2 sync function configuration register	0x002C	R/W
MCPWM_TIMER2_STATUS_REG	PWM timer2 status register	0x0030	RO
Common Configuration for MCPWM Timers			
MCPWM_TIMER_SYNCI_CFG_REG	Synchronization input selection for three PWM timers	0x0034	R/W
MCPWM_OPERATOR_TIMERSEL_REG	Select specific timer for PWM operators	0x0038	R/W
MCPWM Operator 0 Configuration and Status			
MCPWM_GEN0_STMP_CFG_REG	Transfer status and update method for time stamp registers A and B	0x003C	varies
MCPWM_GEN0_TSTMP_A_REG	Shadow register for register A	0x0040	R/W
MCPWM_GEN0_TSTMP_B_REG	Shadow register for register B	0x0044	R/W
MCPWM_GEN0_CFG0_REG	Fault event T0 and T1 handling	0x0048	R/W
MCPWM_GEN0_FORCE_REG	Permissives to force PWM0A and PWM0B outputs by software	0x004C	R/W
MCPWM_GEN0_A_REG	Actions triggered by events on PWM0A	0x0050	R/W
MCPWM_GEN0_B_REG	Actions triggered by events on PWM0B	0x0054	R/W
MCPWM_DT0_CFG_REG	Dead time type selection and configuration	0x0058	R/W

Name	Description	Address	Access
MCPWM_DT0_FED_CFG_REG	Shadow register for falling edge delay (FED)	0x005C	R/W
MCPWM_DT0_RED_CFG_REG	Shadow register for rising edge delay (RED)	0x0060	R/W
MCPWM_CARRIER0_CFG_REG	Carrier enable and configuratoin	0x0064	R/W
MCPWM_FH0_CFG0_REG	Actions on PWM0A and PWM0B trip events	0x0068	R/W
MCPWM_FH0_CFG1_REG	Software triggers for fault handler actions	0x006C	R/W
MCPWM_FH0_STATUS_REG	Status of fault events	0x0070	RO
MCPWM Operator 1 Configuration and Status			
MCPWM_GEN1_STMP_CFG_REG	Transfer status and update method for time stamp registers A and B	0x0074	varies
MCPWM_GEN1_TSTMP_A_REG	Shadow register for register A	0x0078	R/W
MCPWM_GEN1_TSTMP_B_REG	Shadow register for register B	0x007C	R/W
MCPWM_GEN1_CFG0_REG	Fault event T0 and T1 handling	0x0080	R/W
MCPWM_GEN1_FORCE_REG	Permissives to force PWM1A and PWM1B outputs by software	0x0084	R/W
MCPWM_GEN1_A_REG	Actions triggered by events on PWM1A	0x0088	R/W
MCPWM_GEN1_B_REG	Actions triggered by events on PWM1B	0x008C	R/W
MCPWM_DT1_CFG_REG	Dead time type selection and configuration	0x0090	R/W
MCPWM_DT1_FED_CFG_REG	Shadow register for falling edge delay (FED)	0x0094	R/W
MCPWM_DT1_RED_CFG_REG	Shadow register for rising edge delay (RED)	0x0098	R/W
MCPWM_CARRIER1_CFG_REG	Carrier enable and configuratoin	0x009C	R/W
MCPWM_FH1_CFG0_REG	Actions on PWM1A and PWM1B trip events	0x00A0	R/W
MCPWM_FH1_CFG1_REG	Software triggers for fault handler actions	0x00A4	R/W
MCPWM_FH1_STATUS_REG	Status of fault events	0x00A8	RO
MCPWM Operator 2 Configuration and Status			
MCPWM_GEN2_STMP_CFG_REG	Transfer status and update method for time stamp registers A and B	0x00AC	varies
MCPWM_GEN2_TSTMP_A_REG	Shadow register for register A	0x00B0	R/W
MCPWM_GEN2_TSTMP_B_REG	Shadow register for register B	0x00B4	R/W
MCPWM_GEN2_CFG0_REG	Fault event T0 and T1 handling	0x00B8	R/W
MCPWM_GEN2_FORCE_REG	Permissives to force PWM2A and PWM2B outputs by software	0x00BC	R/W
MCPWM_GEN2_A_REG	Actions triggered by events on PWM2A	0x00C0	R/W
MCPWM_GEN2_B_REG	Actions triggered by events on PWM2B	0x00C4	R/W
MCPWM_DT2_CFG_REG	Dead time type selection and configuration	0x00C8	R/W
MCPWM_DT2_FED_CFG_REG	Shadow register for falling edge delay (FED)	0x00CC	R/W
MCPWM_DT2_RED_CFG_REG	Shadow register for rising edge delay (RED)	0x00D0	R/W
MCPWM_CARRIER2_CFG_REG	Carrier enable and configuratoin	0x00D4	R/W
MCPWM_FH2_CFG0_REG	Actions on PWM2A and PWM2B trip events	0x00D8	R/W
MCPWM_FH2_CFG1_REG	Software triggers for fault handler actions	0x00DC	R/W
MCPWM_FH2_STATUS_REG	Status of fault events	0x00E0	RO
Fault Detection Configuration and Status			
MCPWM_FAULT_DETECT_REG	Fault detection configuration and status	0x00E4	varies
Capture Configuration and Status			

Name	Description	Address	Access
MCPWM_CAP_TIMER_CFG_REG	Configure capture timer	0x00E8	varies
MCPWM_CAP_TIMER_PHASE_REG	Phase for capture timer sync	0x00EC	R/W
MCPWM_CAP_CH0_CFG_REG	Capture channel 0 configuration and enable	0x00F0	varies
MCPWM_CAP_CH1_CFG_REG	Capture channel 1 configuration and enable	0x00F4	varies
MCPWM_CAP_CH2_CFG_REG	Capture channel 2 configuration and enable	0x00F8	varies
MCPWM_CAP_CH0_REG	ch0 capture value status register	0x00FC	RO
MCPWM_CAP_CH1_REG	ch1 capture value status register	0x0100	RO
MCPWM_CAP_CH2_REG	ch2 capture value status register	0x0104	RO
MCPWM_CAP_STATUS_REG	Edge of last capture trigger	0x0108	RO
Enable Update of Active Registers			
MCPWM_UPDATE_CFG_REG	Enable update	0x010C	R/W
Manage Interrupts			
MCPWM_INT_ENA_REG	Interrupt enable bits	0x0110	R/W
MCPWM_INT_RAW_REG	Raw interrupt status	0x0114	R/WTC /SS
MCPWM_INT_ST_REG	Masked interrupt status	0x0118	RO
MCPWM_INT_CLR_REG	Interrupt clear bits	0x011C	WT
MCPWM Event Enable Register			
MCPWM_EVT_EN_REG	MCPWM event enable register	0x0120	R/W
MCPWM Task Enable Register			
MCPWM_TASK_EN_REG	MCPWM task enable register	0x0124	R/W
MCPWM APB Configuration Register			
MCPWM_CLK_REG	MCPWM APB configuration register	0x0128	R/W
Version Register			
MCPWM_VERSION_REG	Version register	0x012C	R/W

35.5 Registers

The addresses in this section are relative to Motor Control PWM base address provided in Table 5-2 in Chapter 5 *System and Memory*.

Register 35.1. MCPWM_CLK_CFG_REG (0x0000)

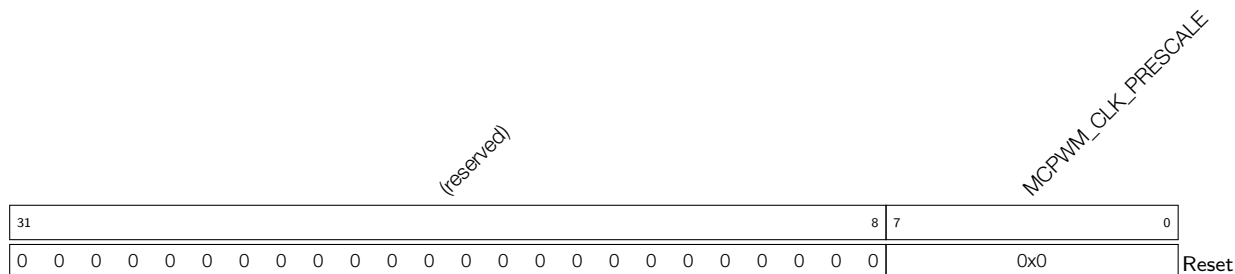

MCPWM_CLK_PRESCALE Configures the prescaler value of clock, so that the period of PWM_CLK = 6.25ns * (PWM_CLK_PRESCALE + 1). (R/W)

Register 35.2. MCPWM_TIMER0_CFG0_REG (0x0004)

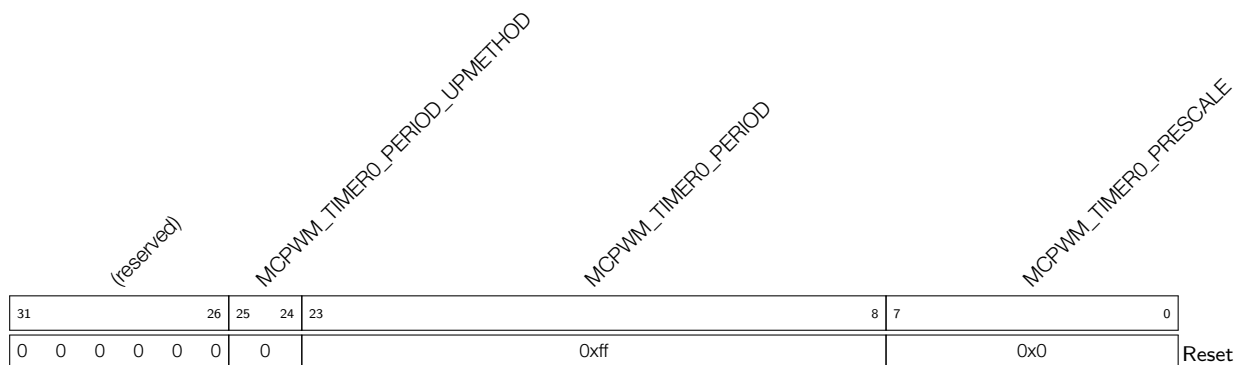

MCPWM_TIMER0_PRESCALE Configures the prescaler value of timer0, so that the period of PT0_CLK = Period of PWM_CLK * (PWM_TIMER0_PRESCALE + 1). (R/W)

MCPWM_TIMER0_PERIOD Configures the period shadow register of PWM timer0. (R/W)

MCPWM_TIMER0_PERIOD_UPMETHOD Configures the update method for active register of PWM timer0 period.

- 0: Immediate
- 1: TEZ
- 2: sync
- 3: TEZ | sync

TEZ here and below means timer equal zero event.
(R/W)

Register 35.3. MCPWM_TIMER0_CFG1_REG (0x0008)

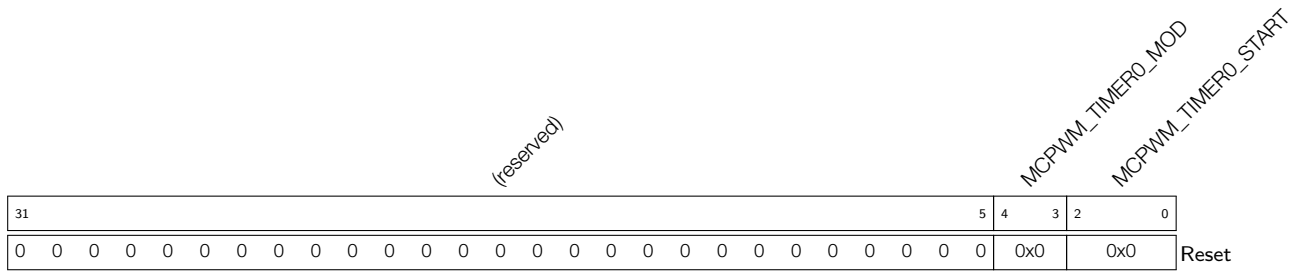

MCPWM_TIMER0_START Configures whether or not to start/stop PWM timer0.

- 0: If PWM timer0 starts, then stops at TEZ
- 1: If timer0 starts, then stops at TEP
- 2: PWM timer0 starts and runs on
- 3: Timer0 starts and stops at the next TEZ
- 4: Timer0 starts and stops at the next TEP
- 5: Invalid. No effect
- 6: Invalid. No effect
- 7: Invalid. No effect

TEP here and below means the event that happens when the timer equals to period.

(R/W/SC)

MCPWM_TIMER0_MOD Configures the working mode of PWM timer0.

- 0: Freeze
- 1: Increase mode
- 2: Decrease mode
- 3: Up-down mode

(R/W)

Register 35.4. MCPWM_TIMER0_SYNC_REG (0x000C)

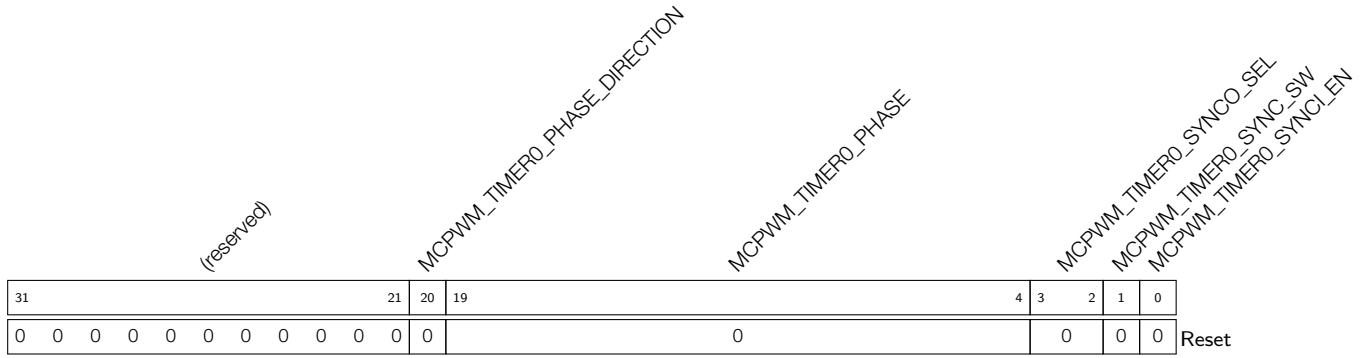

MCPWM_TIMER0_SYNCLEN Configures whether or not to enable timer reloading with phase on sync input event.

- 0: Disable
- 1: Enable

(R/W)

MCPWM_TIMER0_SYNC_SW Toggling this bit will trigger a software sync. (R/W)

MCPWM_TIMER0_SYNC_SEL PWM timer0 sync out selection.

0: sync_in. The sync out will always generate when toggling the [MCPWM_TIMER0_SYNC_SW](#) bit.

- 1: TEZ
- 2: TEP
- 3: No effect

(R/W)

MCPWM_TIMER0_PHASE Phase for timer reload on sync event. (R/W)

MCPWM_TIMER0_PHASE_DIRECTION Configures the PWM timer0's direction when timer0 mode is up-down mode.

- 0: Increase
- 1: Decrease

(R/W)

Register 35.5. MCPWM_TIMER0_STATUS_REG (0x0010)

(reserved)										MCPWM_TIMER0_DIRECTION						MCPWM_TIMER0_VALUE						Reset
31											17	16	15							0		
0 0 0 0 0 0 0 0 0 0 0 0 0 0 0 0										0						0						

MCPWM_TIMER0_VALUE Represents current PWM timer0 counter value. (RO)

MCPWM_TIMER0_DIRECTION Represents current PWM timer0 counter direction.

0: Increment

1: Decrement

(RO)

Register 35.6. MCPWM_TIMER1_CFG0_REG (0x0014)

(reserved)										MCPWM_TIMER1_PERIOD_UPMETHOD						MCPWM_TIMER1_PERIOD						MCPWM_TIMER1_PRESCALE						Reset	
31											26	25	24	23							8	7							0
0 0 0 0 0 0 0 0 0 0										0						0xff						0x0							

MCPWM_TIMER1_PRESCALE Configures the prescaler value of timer1, so that the period of $PT0_CLK = \text{Period of PWM_CLK} * (\text{PWM_timer1_PRESCALE} + 1)$. (R/W)

MCPWM_TIMER1_PERIOD Period shadow register of PWM timer1. (R/W)

MCPWM_TIMER1_PERIOD_UPMETHOD Configures the update method for active register of PWM timer1 period.

0: Immediate

1: TEZ

2: Sync

3: TEZ | sync

TEZ here and below means timer equal zero event.

(R/W)

Register 35.7. MCPWM_TIMER1_CFG1_REG (0x0018)

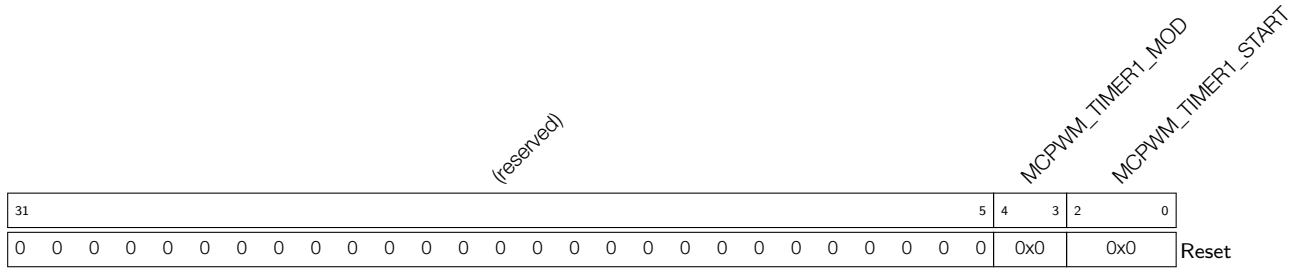

MCPWM_TIMER1_START Configures whether or not to start/stop PWM timer1.

- 0: If PWM timer1 starts, then stops at TEZ
 - 1: If timer1 starts, then stops at TEP
 - 2: PWM timer1 starts and runs on
 - 3: Timer1 starts and stops at the next TEZ
 - 4: Timer1 starts and stops at the next TEP
 - 5-7: Invalid. No effect
- TEP here and below means the event that happens when the timer equals to period.
(R/W/SC)

MCPWM_TIMER1_MOD Configures the working mode of PWM timer1.

- 0: Freeze
 - 1: Increase mode
 - 2: Decrease mode
 - 3: Up-down mode
- (R/W)

Register 35.8. MCPWM_TIMER1_SYNC_REG (0x001C)

(reserved)										MCPWM_TIMER1_PHASE_DIRECTION		MCPWM_TIMER1_PHASE				MCPWM_TIMER1_SYNCO_SEL			MCPWM_TIMER1_SYNC_SW		MCPWM_TIMER1_SYNCI_EN	
31																						
0	0	0	0	0	0	0	0	0	0	0	0	0	0	0	0	0	0	0	0	0		

Reset

MCPWM_TIMER1_SYNCI_EN Configures whether or not to enable timer reloading with phase on sync input event.

0: Disable

1: Enable

(R/W)

MCPWM_TIMER1_SYNC_SW Toggling this bit will trigger a software sync. (R/W)

MCPWM_TIMER1_SYNCO_SEL Configures PWM timer1 sync out selection.

0: sync_in

1: TEZ

2: TEP, and sync out will always generate when toggling the reg_timer1_sync_sw bit.

3: No effect

(R/W)

MCPWM_TIMER1_PHASE Phase for timer reload on sync event. (R/W)

MCPWM_TIMER1_PHASE_DIRECTION Configures the PWM timer1's direction when timer1 is in up-down mode.

0: Increase

1: Decrease

(R/W)

Register 35.9. MCPWM_TIMER1_STATUS_REG (0x0020)

(reserved)										MCPWM_TIMER1_DIRECTION							MCPWM_TIMER1_VALUE					
31											17	16	15						0			
0 0 0 0 0 0 0 0 0 0										0							0					Reset

MCPWM_TIMER1_VALUE Represents current PWM timer1 counter value. (RO)

MCPWM_TIMER1_DIRECTION Represents current PWM timer1 counter direction.

0: Increment

1: Decrement

(RO)

Register 35.10. MCPWM_TIMER2_CFG0_REG (0x0024)

(reserved)							MCPWM_TIMER2_PERIOD_UPMETHOD							MCPWM_TIMER2_PERIOD							MCPWM_TIMER2_PRESCALE							
31				26	25	24	23								8	7						0						
0 0 0 0 0 0							0							0xff							0x0							Reset

MCPWM_TIMER2_PRESCALE Configures the prescaler value of timer2, so that the period of $PT0_CLK = \text{Period of PWM_CLK} * (\text{PWM_timer2_PRESCALE} + 1)$. (R/W)

MCPWM_TIMER2_PERIOD Period shadow register of PWM timer2. (R/W)

MCPWM_TIMER2_PERIOD_UPMETHOD Configures the update method for active register of PWM timer2 period.

0: Immediate

1: TEZ

2: Sync

3: TEZ | sync

TEZ here and below means timer equal zero event.

(R/W)

Register 35.11. MCPWM_TIMER2_CFG1_REG (0x0028)

(reserved)																MCPWM_TIMER2_MOD		MCPWM_TIMER2_START			
31																	5	4	3	2	0
0 0																0x0		0x0		Reset	

MCPWM_TIMER2_START Configures whether or not to start/stop PWM timer2.

- 0: If PWM timer2 starts, then stops at TEZ
- 1: If timer2 starts, then stops at TEP
- 2: PWM timer2 starts and runs on
- 3: Timer2 starts and stops at the next TEZ
- 4: Timer2 starts and stops at the next TEP
- 5: Invalid. No effect
- 6: Invalid. No effect
- 7: Invalid. No effect

TEP here and below means the event that happens when the timer equals to period.

(R/W/SC)

MCPWM_TIMER2_MOD Configures the working mode of PWM timer2.

- 0: Freeze
- 1: Increase mode
- 2: Decrease mode
- 3: Up-down mode

(R/W)

Register 35.12. MCPWM_TIMER2_SYNC_REG (0x002C)

(reserved)										MCPWM_TIMER2_PHASE_DIRECTION		MCPWM_TIMER2_PHASE				MCPWM_TIMER2_SYNC_SEL			MCPWM_TIMER2_SYNC_SW		MCPWM_TIMER2_SYNCI_EN		
31										21	20	19				4	3	2	1	0			
0 0 0 0 0 0 0 0 0 0										0		0				0			0		0		Reset

MCPWM_TIMER2_SYNCI_EN Configures whether or not to enable timer reloading with phase on sync input event.

0: Disable

1: Enable

(R/W)

MCPWM_TIMER2_SYNC_SW Toggling this bit will trigger a software sync. (R/W)

MCPWM_TIMER2_SYNCO_SEL PWM timer2 sync out selection.

0: sync_in

1: TEZ

2: TEP, and sync out will always generate when toggling the reg_timer0_sync_sw bit

3: No effect

(R/W)

MCPWM_TIMER2_PHASE Configures phase for timer reload on sync event. (R/W)

MCPWM_TIMER2_PHASE_DIRECTION Configures the PWM timer2's direction when timer2 is in up-down mode.

0: Increase

1: Decrease

(R/W)

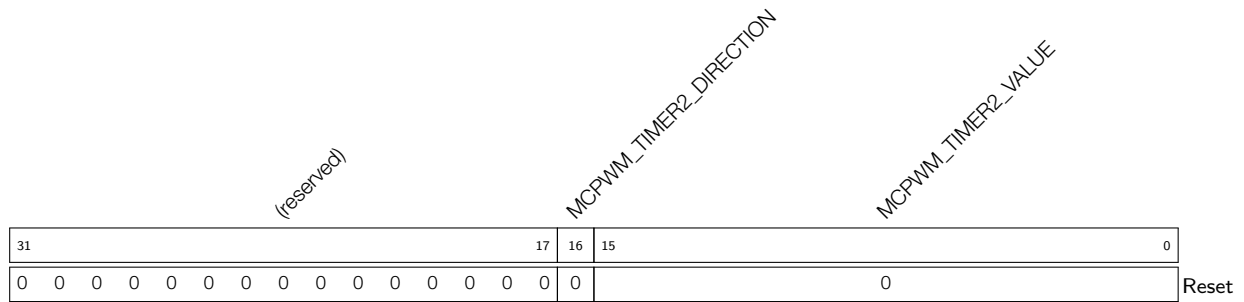
Register 35.13. MCPWM_TIMER2_STATUS_REG (0x0030)

MCPWM_TIMER2_VALUE Represents current PWM timer2 counter value. (RO)

MCPWM_TIMER2_DIRECTION Represents current PWM timer2 counter direction.

0: Increment

1: Decrement

(RO)

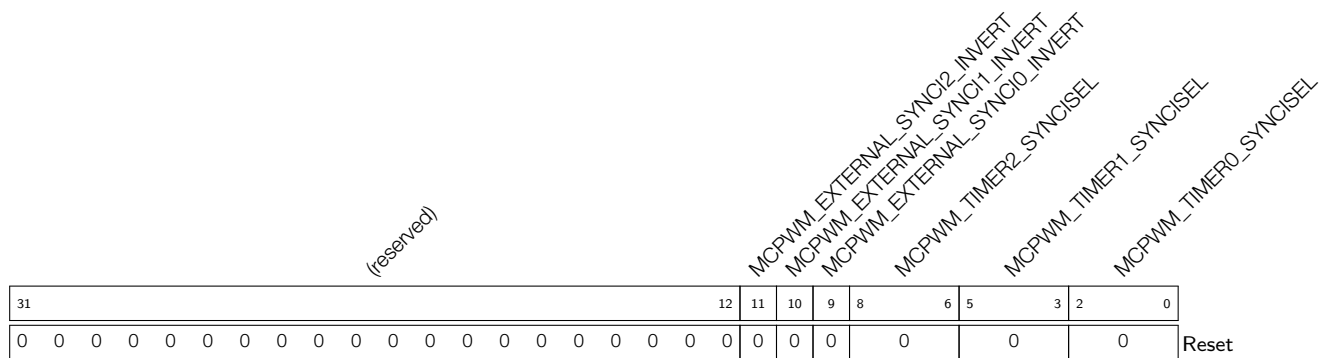
Register 35.14. MCPWM_TIMER_SYNCI_CFG_REG (0x0034)

MCPWM_TIMER0_SYNCISEL Configures sync input for PWM timer0.

- 1: PWM timer0 sync out
 - 2: PWM timer1 sync out
 - 3: PWM timer2 sync out
 - 4: SYNC0 from GPIO matrix
 - 5: SYNC1 from GPIO matrix
 - 6: SYNC2 from GPIO matrix
- Other values: no sync input selected
(R/W)

MCPWM_TIMER1_SYNCISEL Select sync input for PWM timer1.

- 1: PWM timer0 sync out
 - 2: PWM timer1 sync out
 - 3: PWM timer2 sync out
 - 4: SYNC0 from GPIO matrix
 - 5: SYNC1 from GPIO matrix
 - 6: SYNC2 from GPIO matrix
- Other values: no sync input selected
(R/W)

MCPWM_TIMER2_SYNCISEL Select sync input for PWM timer2.

- 1: PWM timer0 sync out
 - 2: PWM timer1 sync out
 - 3: PWM timer2 sync out
 - 4: SYNC0 from GPIO matrix
 - 5: SYNC1 from GPIO matrix
 - 6: SYNC2 from GPIO matrix
- Other values: no sync input selected
(R/W)

MCPWM_EXTERNAL_SYNCI0_INVERT Invert SYNC0 from GPIO matrix. (R/W)

MCPWM_EXTERNAL_SYNCI1_INVERT Invert SYNC1 from GPIO matrix. (R/W)

MCPWM_EXTERNAL_SYNCI2_INVERT Invert SYNC2 from GPIO matrix. (R/W)

Register 35.15. MCPWM_OPERATOR_TIMERSEL_REG (0x0038)

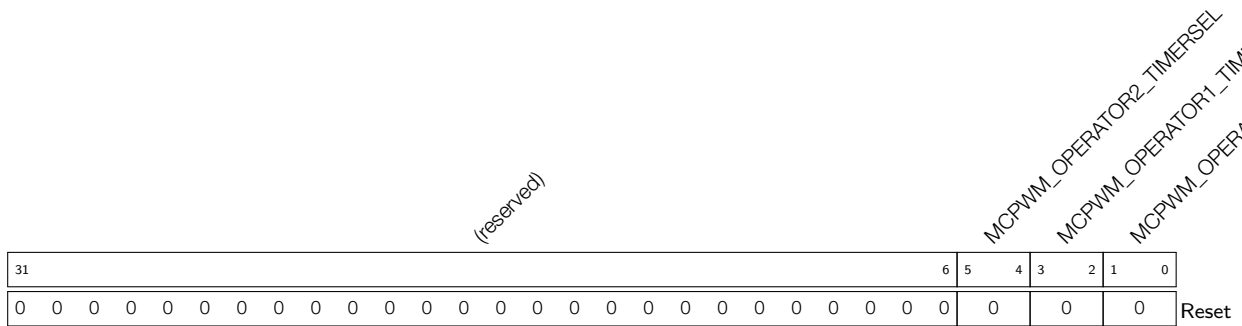

MCPWM_OPERATOR0_TIMERSEL Configures which PWM timer will be the timing reference for PWM operator0.

- 0: timer0
- 1: timer1
- 2: timer2
- 3: Invalid

(R/W)

MCPWM_OPERATOR1_TIMERSEL Configures which PWM timer will be the timing reference for PWM operator1.

- 0: timer0
- 1: timer1
- 2: timer2
- 3: Invalid

(R/W)

MCPWM_OPERATOR2_TIMERSEL Configures which PWM timer will be the timing reference for PWM operator2.

- 0: timer0
- 1: timer1
- 2: timer2
- 3: Invalid

(R/W)

Register 35.16. MCPWM_GEN0_STMP_CFG_REG (0x003C)

(reserved)										MCPWM_GEN0_B_SHDW_FULL				MCPWM_GEN0_A_SHDW_FULL				MCPWM_GEN0_B_UPMETHOD				MCPWM_GEN0_A_UPMETHOD						
31											10	9	8	7					4	3					0			
0										0										0				0				Reset

MCPWM_GEN0_A_UPMETHOD Configures the update method for PWM generator 0 time stamp

A's active register.

When all bits are set to 0: Immediately

When bit0 is set to 1: TEZ

When bit1 is set to 1: TEP

When bit2 is set to 1: Sync

When bit3 is set to 1: Disable the update

(R/W)

MCPWM_GEN0_B_UPMETHOD Configures the update method for PWM generator 0 time stamp

B's active register. (R/W)

When all bits are set to 0: Immediately

When bit0 is set to 1: TEZ

When bit1 is set to 1: TEP

When bit2 is set to 1: Sync

When bit3 is set to 1: Disable the update

(R/W)

MCPWM_GEN0_A_SHDW_FULL Set and reset by hardware.

0: A's active reg has been updated with shadow register latest value.

1: PWM generator 0 time stamp A's shadow reg is filled and waiting to be transferred to A's active reg.

(R/SC/WTC)

MCPWM_GEN0_B_SHDW_FULL Set and reset by hardware.

0: B's active reg has been updated with shadow register latest value.

1: PWM generator 0 time stamp B's shadow reg is filled and waiting to be transferred to B's active reg.

(R/SC/WTC)

Register 35.17. MCPWM_GEN0_TSTMP_A_REG (0x0040)

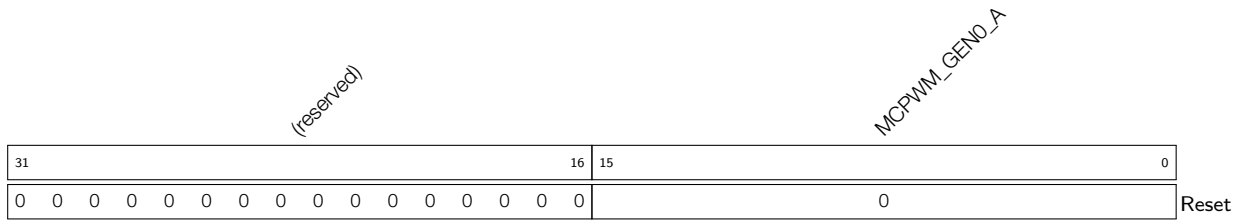

MCPWM_GEN0_A Shadow register for PWM generator 0 time stamp A. (R/W)

Register 35.18. MCPWM_GEN0_TSTMP_B_REG (0x0044)

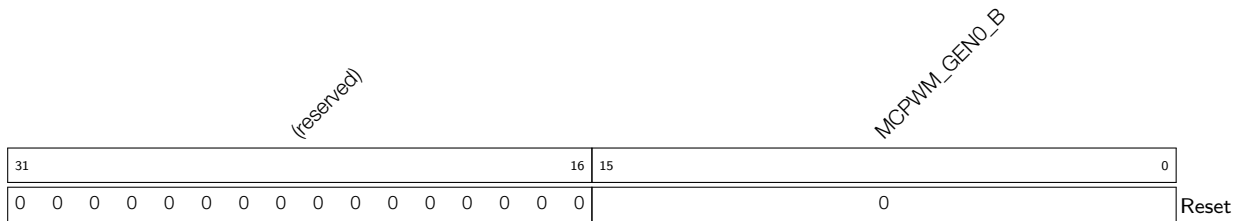

MCPWM_GEN0_B Shadow register for PWM generator 0 time stamp B. (R/W)

Register 35.19. MCPWM_GEN0_CFG0_REG (0x0048)

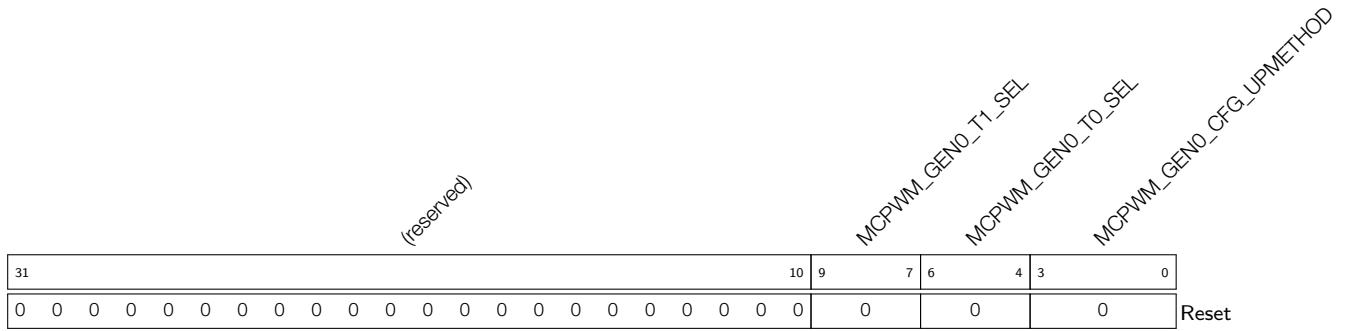

MCPWM_GEN0_CFG_UPMETHOD Configures update method for PWM generator 0's active register.

When all bits are set to 0: Immediately

When bit0 is set to 1: TEZ

When bit1 is set to 1: TEP

When bit2 is set to 1: Sync

When bit3 is set to 1: Disable the update

(R/W)

MCPWM_GEN0_T0_SEL Configures source selection for PWM generator 0 event_t0, take effect immediately.

0: fault_event0

1: fault_event1

2: fault_event2

3: sync_taken

4: None

(R/W)

MCPWM_GEN0_T1_SEL Configures source selection for PWM generator 0 event_t1, take effect immediately

0: fault_event0

1: fault_event1

2: fault_event2

3: sync_taken

4: None

(R/W)

Register 35.20. MCPWM_GEN0_FORCE_REG (0x004C)

(reserved)																MCPWM_GEN0_B_NCIFORCE_MODE		MCPWM_GEN0_B_CNTUFORCE_MODE		MCPWM_GEN0_A_NCIFORCE_MODE		MCPWM_GEN0_A_CNTUFORCE_MODE		MCPWM_GEN0_A_CNTUFORCE_UPMETHOD			
31															16	15	14	13	12	11	10	9	8	7	6	5	0
0																0	0	0	0	0	0	0	0	0	0x20		Reset

MCPWM_GEN0_CNTUFORCE_UPMETHOD Configures update method for continuous software force of PWM generator0.

When all bits are set to 0: Immediately

When bit0 is set to 1: TEZ

When bit1 is set to 1: TEP

When bit2 is set to 1: TEA

When bit3 is set to 1: TEB

When bit4 is set to 1: Sync

When bit5 is set to 1: Disable update

TEA/B means an event generated when the timer's value equals to that of register A/B.

(R/W)

MCPWM_GEN0_A_CNTUFORCE_MODE Configures continuous software force mode for PWM0A.

0: Disabled

1: Low

2: High

3: Disabled

(R/W)

MCPWM_GEN0_B_CNTUFORCE_MODE Configures continuous software force mode for PWM0B.

See details in [MCPWM_GEN0_A_CNTUFORCE_MODE](#). (R/W)

MCPWM_GEN0_A_NCIFORCE Configures whether or not to trigger a non-continuous immediate software-force event for PWM0A.

0: No effect

1: Trigger a force event

(R/W)

MCPWM_GEN0_A_NCIFORCE_MODE Configures non-continuous immediate software force mode for PWM0A.

0: Disabled

1: Low

2: High

3: Disabled

(R/W)

Continued on the next page...

Register 35.20. MCPWM_GEN0_FORCE_REG (0x004C)

Continued from the previous page...

MCPWM_GEN0_B_NCIFORCE Configures whether or not to trigger a non-continuous immediate software-force event for PWM0B.

0: No effect

1: Trigger a force event

(R/W)

MCPWM_GEN0_B_NCIFORCE_MODE Configures non-continuous immediate software force mode for PWM0B. See details in [MCPWM_GEN0_A_NCIFORCE_MODE](#). (R/W)

Register 35.21. MCPWM_GEN0_A_REG (0x0050)

(reserved)								MCPWM_GEN0_A_DT1	MCPWM_GEN0_A_DT0	MCPWM_GEN0_A_DTEB	MCPWM_GEN0_A_DTEA	MCPWM_GEN0_A_DTEP	MCPWM_GEN0_A_DTEZ	MCPWM_GEN0_A_UT1	MCPWM_GEN0_A_UT0	MCPWM_GEN0_A_UTEA	MCPWM_GEN0_A_UTEB	MCPWM_GEN0_A_UTEA	MCPWM_GEN0_A_UTEZ							
31	24	23	22	21	20	19	18	17	16	15	14	13	12	11	10	9	8	7	6	5	4	3	2	1	0	
0	0	0	0	0	0	0	0	0	0	0	0	0	0	0	0	0	0	0	0	0	0	0	0	0	0	Reset

MCPWM_GEN0_A_UTEZ Configures action on PWM0A triggered by event TEZ when timer increasing.

- 0: No change
 - 1: Low
 - 2: High
 - 3: Toggle
- (R/W)

MCPWM_GEN0_A_UTEA Configures action on PWM0A triggered by event TEA when timer increasing. See details in [MCPWM_GEN0_A_UTEZ](#). (R/W)

MCPWM_GEN0_A_UTEB Configures action on PWM0A triggered by event TEB when timer increasing. See details in [MCPWM_GEN0_A_UTEZ](#). (R/W)

MCPWM_GEN0_A_UT0 Configures action on PWM0A triggered by event_t0 when timer increasing. See details in [MCPWM_GEN0_A_UTEZ](#). (R/W)

MCPWM_GEN0_A_UT1 Configures action on PWM0A triggered by event_t1 when timer increasing. See details in [MCPWM_GEN0_A_UTEZ](#). (R/W)

MCPWM_GEN0_A_DTEZ Configures action on PWM0A triggered by event TEZ when timer decreasing. See details in [MCPWM_GEN0_A_UTEZ](#). (R/W)

MCPWM_GEN0_A_DTEA Configures action on PWM0A triggered by event TEA when timer decreasing. See details in [MCPWM_GEN0_A_UTEZ](#). (R/W)

MCPWM_GEN0_A_DTEB Configures action on PWM0A triggered by event TEB when timer decreasing. See details in [MCPWM_GEN0_A_UTEZ](#). (R/W)

MCPWM_GEN0_A_DT0 Configures action on PWM0A triggered by event_t0 when timer decreasing. See details in [MCPWM_GEN0_A_UTEZ](#). (R/W)

MCPWM_GEN0_A_DT1 Configures action on PWM0A triggered by event_t1 when timer decreasing. See details in [MCPWM_GEN0_A_UTEZ](#). (R/W)

Register 35.22. MCPWM_GEN0_B_REG (0x0054)

(reserved)								MCPWM_GEN0_B_DT1 MCPWM_GEN0_B_DT0 MCPWM_GEN0_B_DTEB MCPWM_GEN0_B_DTEA MCPWM_GEN0_B_DTEP MCPWM_GEN0_B_DTEZ MCPWM_GEN0_B_UT1 MCPWM_GEN0_B_UT0 MCPWM_GEN0_B_UTEA MCPWM_GEN0_B_UTEB MCPWM_GEN0_B_UTEA MCPWM_GEN0_B_UTEZ																								
31								24	23	22	21	20	19	18	17	16	15	14	13	12	11	10	9	8	7	6	5	4	3	2	1	0
0	0	0	0	0	0	0	0	0	0	0	0	0	0	0	0	0	0	0	0	0	0	0	0	0	0	0	0	0	0	0	0	0

Reset

MCPWM_GEN0_B_UTEZ Configures action on PWM0B triggered by event TEZ when timer increasing.

0: No change

1: Low.

2: High.

3: Toggle

(R/W)

MCPWM_GEN0_B_UTEA Configures action on PWM0B triggered by event TEA when timer increasing. See details in [MCPWM_GEN0_B_UTEZ](#). (R/W)

MCPWM_GEN0_B_UTEB Configures action on PWM0B triggered by event TEB when timer increasing. See details in [MCPWM_GEN0_B_UTEZ](#). (R/W)

MCPWM_GEN0_B_UT0 Configures action on PWM0B triggered by event_t0 when timer increasing. See details in [MCPWM_GEN0_B_UTEZ](#). (R/W)

MCPWM_GEN0_B_UT1 Configures action on PWM0B triggered by event_t1 when timer increasing. See details in [MCPWM_GEN0_B_UTEZ](#). (R/W)

MCPWM_GEN0_B_DTEZ Configures action on PWM0B triggered by event TEZ when timer decreasing. See details in [MCPWM_GEN0_B_UTEZ](#). (R/W)

MCPWM_GEN0_B_DTEA Configures action on PWM0B triggered by event TEA when timer decreasing. See details in [MCPWM_GEN0_B_UTEZ](#). (R/W)

MCPWM_GEN0_B_DTEB Configures action on PWM0B triggered by event TEB when timer decreasing. See details in [MCPWM_GEN0_B_UTEZ](#). (R/W)

MCPWM_GEN0_B_DTEP Configures action on PWM0B triggered by event TEP when timer decreasing. See details in [MCPWM_GEN0_B_UTEZ](#). (R/W)

MCPWM_GEN0_B_DTEZ Configures action on PWM0B triggered by event TEZ when timer decreasing. See details in [MCPWM_GEN0_B_UTEZ](#). (R/W)

MCPWM_GEN0_B_DT0 Configures action on PWM0B triggered by event_t0 when timer decreasing. See details in [MCPWM_GEN0_B_UTEZ](#). (R/W)

MCPWM_GEN0_B_DT1 Configures action on PWM0B triggered by event_t1 when timer decreasing. See details in [MCPWM_GEN0_B_UTEZ](#). (R/W)

Register 35.23. MCPWM_DT0_CFG_REG (0x0058)

(reserved)																		MCPWM_DT0_CLK_SEL	MCPWM_DT0_B_OUTBYPASS	MCPWM_DT0_A_OUTBYPASS	MCPWM_DT0_FED_OUTINVERT	MCPWM_DT0_RED_OUTINVERT	MCPWM_DT0_FED_INSEL	MCPWM_DT0_RED_INSEL	MCPWM_DT0_B_OUTSWAP	MCPWM_DT0_A_OUTSWAP	MCPWM_DT0_DEB_MODE	MCPWM_DT0_RED_UPMETHOD	MCPWM_DT0_FED_UPMETHOD				
31	30	29	28	27	26	25	24	23	22	21	20	19	18	17	16	15	14	13	12	11	10	9	8	7	6	5	4	3	2	1	0		
0	0	0	0	0	0	0	0	0	0	0	0	0	0	0	0	0	0	0	0	0	0	0	0	0	0	0	0	0	0	0	0	0	0

Reset

MCPWM_DT0_FED_UPMETHOD Configures update method for FED active register.

0: Immediate

When bit0 is set to 1: TEZ

When bit1 is set to 1: TEP

When bit2 is set to 1: sync

When bit3 is set to 1: disable the update (R/W)

MCPWM_DT0_RED_UPMETHOD Update method for RED active register. See details in [MCPWM_DT0_FED_UPMETHOD](#). (R/W)

MCPWM_DT0_DEB_MODE S8 in table 35-5, dual-edge B mode.

0: FED/RED take effect on different path separately

1: FED/RED take effect on B path, A out is in bypass or dupB mode

(R/W)

MCPWM_DT0_A_OUTSWAP S6 in table 35-5. (R/W)

MCPWM_DT0_B_OUTSWAP S7 in table 35-5. (R/W)

MCPWM_DT0_RED_INSEL S4 in table 35-5. (R/W)

MCPWM_DT0_FED_INSEL S5 in table 35-5. (R/W)

MCPWM_DT0_RED_OUTINVERT S2 in table 35-5. (R/W)

MCPWM_DT0_FED_OUTINVERT S3 in table 35-5. (R/W)

MCPWM_DT0_A_OUTBYPASS S1 in table 35-5. (R/W)

MCPWM_DT0_B_OUTBYPASS S0 in table 35-5. (R/W)

MCPWM_DT0_CLK_SEL Configures dead time generator 0 clock selection.

0: PWM_CLK

1: PT_CLK

(R/W)

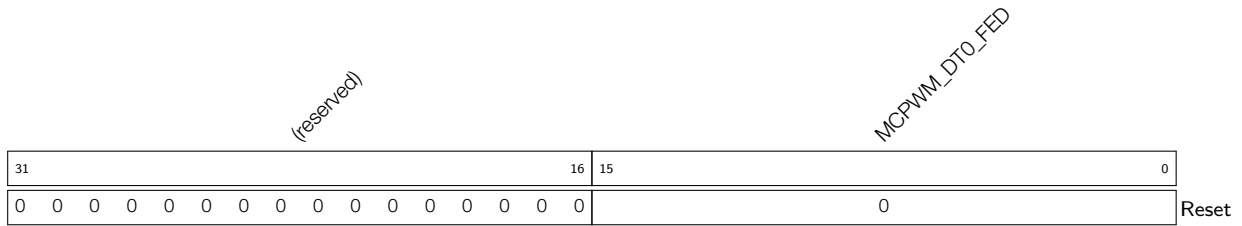
Register 35.24. MCPWM_DT0_FED_CFG_REG (0x005C)

MCPWM_DT0_FED Shadow register for FED. (R/W)

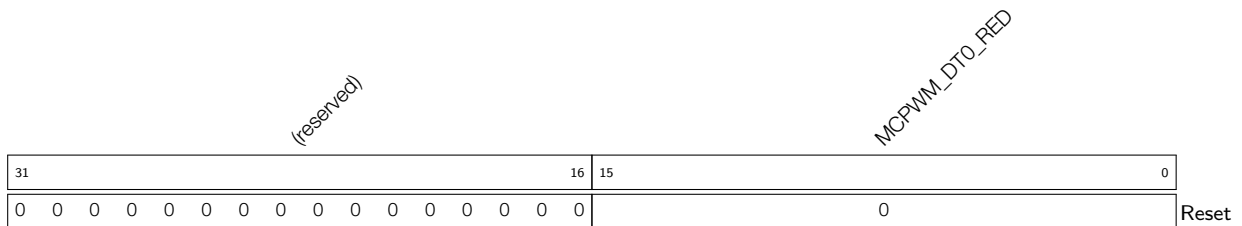
Register 35.25. MCPWM_DT0_RED_CFG_REG (0x0060)

MCPWM_DT0_RED Shadow register for RED. (R/W)

Register 35.26. MCPWM_CARRIER0_CFG_REG (0x0064)

(reserved)														MCPWM_CARRIER0_IN_INVERT		MCPWM_CARRIER0_OUT_INVERT		MCPWM_CARRIER0_OSHTWTH		MCPWM_CARRIER0_DUTY		MCPWM_CARRIER0_PRESCALE		MCPWM_CARRIER0_EN						
31															14	13	12	11			8	7			5	4			1	0
0														0	0	0	0	0	0	0	0	0	0	0	0	Reset				

MCPWM_CARRIER0_EN Configures whether or not to enable carrier0.

0: Bypass

1: Enable

(R/W)

MCPWM_CARRIER0_PRESCALE Configures the prescale value of PWM carrier0 clock (PC_CLK), so that period of PC_CLK = period of PWM_CLK * (PWM_CARRIER0_PRESCALE + 1). (R/W)

MCPWM_CARRIER0_DUTY Configures carrier duty selection. Duty = PWM_CARRIER0_DUTY/8. (R/W)

MCPWM_CARRIER0_OSHTWTH Configures width of the first pulse in number of periods of the carrier. (R/W)

MCPWM_CARRIER0_OUT_INVERT Configures whether or not to invert the output of PWM0A and PWM0B for this submodule.

0: No effect

1: Invert

(R/W)

MCPWM_CARRIER0_IN_INVERT Configures whether or not to invert the input of PWM0A and PWM0B for this submodule.

0: No effect

1: Invert

(R/W)

Register 35.27. MCPWM_FH0_CFG0_REG (0x0068)

(reserved)								MCPWM_FH0_B_OST_U		MCPWM_FH0_B_OST_D		MCPWM_FH0_B_CBC_U		MCPWM_FH0_B_CBC_D		MCPWM_FH0_A_OST_U		MCPWM_FH0_A_OST_D		MCPWM_FH0_A_CBC_U		MCPWM_FH0_A_CBC_D		MCPWM_FH0_F0_OST		MCPWM_FH0_F1_OST		MCPWM_FH0_F2_OST		MCPWM_FH0_SW_OST		MCPWM_FH0_F0_CBC		MCPWM_FH0_F1_CBC		MCPWM_FH0_F2_CBC		MCPWM_FH0_SW_CBC		
31	30	29	28	27	26	25	24	23	22	21	20	19	18	17	16	15	14	13	12	11	10	9	8	7	6	5	4	3	2	1	0									
0	0	0	0	0	0	0	0	0	0	0	0	0	0	0	0	0	0	0	0	0	0	0	0	0	0	0	0	0	0	0	0	0	0	0	0	0	0	0	0	Reset

MCPWM_FH0_SW_CBC Configures whether or not to enable software force cycle-by-cycle mode action.

- 0: Disable
 - 1: Enable
- (R/W)

MCPWM_FH0_F2_CBC Configures whether or not fault_event2 will trigger cycle-by-cycle mode action.

- 0: Disable
 - 1: Enable
- (R/W)

MCPWM_FH0_F1_CBC Configures whether or not fault_event1 will trigger cycle-by-cycle mode action. See details in [MCPWM_FH0_F2_CBC](#). (R/W)

MCPWM_FH0_F0_CBC Configures whether or not fault_event0 will trigger cycle-by-cycle mode action. See details in [MCPWM_FH0_F2_CBC](#). (R/W)

MCPWM_FH0_SW_OST Configures whether or not to enable software force one-shot mode action. See details in [MCPWM_FH0_SW_CBC](#). (R/W)

MCPWM_FH0_F2_OST Configures whether or not fault_event2 will trigger one-shot mode action. See details in [MCPWM_FH0_F2_CBC](#). (R/W)

MCPWM_FH0_F1_OST Configures whether or not fault_event1 will trigger one-shot mode action. See details in [MCPWM_FH0_F2_CBC](#). (R/W)

MCPWM_FH0_F0_OST Configures whether or not fault_event0 will trigger one-shot mode action. See details in [MCPWM_FH0_F2_CBC](#). (R/W)

MCPWM_FH0_A_CBC_D Configures cycle-by-cycle mode action on PWM0A when fault event occurs and timer is decreasing.

- 0: Do nothing
 - 1: Force low
 - 2: Force high
 - 3: Toggle
- (R/W)

MCPWM_FH0_A_CBC_U Configures cycle-by-cycle mode action on PWM0A when fault event occurs and timer is increasing. See details in [MCPWM_FH0_A_CBC_D](#). (R/W)

Continued on the next page...

Register 35.27. MCPWM_FH0_CFG0_REG (0x0068)

Continued from the previous page...

MCPWM_FH0_A_OST_D Configures one-shot mode action on PWM0A when fault event occurs and timer is decreasing. See details in [MCPWM_FH0_A_CBC_D](#). (R/W)

MCPWM_FH0_A_OST_U Configures one-shot mode action on PWM0A when fault event occurs and timer is increasing. See details in [MCPWM_FH0_A_CBC_D](#). (R/W)

MCPWM_FH0_B_CBC_D Configures cycle-by-cycle mode action on PWM0B when fault event occurs and timer is decreasing. See details in [MCPWM_FH0_A_CBC_D](#). (R/W)

MCPWM_FH0_B_CBC_U Configures cycle-by-cycle mode action on PWM0B when fault event occurs and timer is increasing. See details in [MCPWM_FH0_A_CBC_D](#). (R/W)

MCPWM_FH0_B_OST_D Configures one-shot mode action on PWM0B when fault event occurs and timer is decreasing. See details in [MCPWM_FH0_A_CBC_D](#). (R/W)

MCPWM_FH0_B_OST_U Configures one-shot mode action on PWM0B when fault event occurs and timer is increasing. See details in [MCPWM_FH0_A_CBC_D](#). (R/W)

Register 35.32. MCPWM_GEN1_TSTMP_B_REG (0x007C)

(reserved)															MCPWM_GEN1_B																
31															16	15															0
0 0 0 0 0 0 0 0 0 0 0 0 0 0 0															0																Reset

MCPWM_GEN1_B Shadow register for PWM generator 1 time stamp B. (R/W)

Register 35.33. MCPWM_GEN1_CFG0_REG (0x0080)

(reserved)																			MCPWM_GEN1_T1_SEL	MCPWM_GEN1_T0_SEL	MCPWM_GEN1_CFG_UPMETHOD						
31																		10	9	7	6	4	3			0	
0 0 0 0 0 0 0 0 0 0 0 0 0 0 0 0 0 0 0																			0	0	0	0	0	0			Reset

MCPWM_GEN1_CFG_UPMETHOD Configures update method for PWM generator 1's active register of configuration.

When all bits are set to 0: immediately

When bit0 is set to 1: TEZ

When bit1 is set to 1: sync

When bit3 is set to 1: disable the update

(R/W)

MCPWM_GEN1_T0_SEL Configures source selection for PWM generator 1 event_t0, take effect immediately.

0: fault_event0

1: fault_event1.

2: fault_event2

3: sync_taken

4: None

(R/W)

MCPWM_GEN1_T1_SEL Configures source selection for PWM generator 1 event_t1, take effect immediately. See details in [MCPWM_GEN1_T0_SEL](#). (R/W)

Register 35.34. MCPWM_GEN1_FORCE_REG (0x0084)

(reserved)																MCPWM_GEN1_B_NCIFORCE_MODE		MCPWM_GEN1_B_NCIFORCE		MCPWM_GEN1_A_NCIFORCE_MODE		MCPWM_GEN1_A_NCIFORCE		MCPWM_GEN1_B_CNTUFORCE_MODE		MCPWM_GEN1_A_CNTUFORCE_MODE		MCPWM_GEN1_CNTUFORCE_UPMETHOD	
31															16	15	14	13	12	11	10	9	8	7	6	5	0		
0																0	0	0	0	0	0	0	0	0	0	0x20		Reset	

MCPWM_GEN1_CNTUFORCE_UPMETHOD Configures updating method for continuous software force of PWM generator 1.

When all bits are set to 0: immediately

When bit0 is set to 1: TEZ

When bit1 is set to 1: TEP

When bit2 is set to 1: TEA

When bit3 is set to 1: TEB

When bit4 is set to 1: sync

When bit5 is set to 1: disable update

TEA/B here and below means an event generated when the timer's value equals to that of register A/B.

(R/W)

MCPWM_GEN1_A_CNTUFORCE_MODE Continuous software force mode for PWM1A.

0: Disabled

1: Low

2: High

3: Disabled

(R/W)

MCPWM_GEN1_B_CNTUFORCE_MODE Configures continuous software force mode for PWM1B.

See details in [MCPWM_GEN1_A_CNTUFORCE_MODE](#). (R/W)

MCPWM_GEN1_A_NCIFORCE Configures whether or not to trigger a non-continuous immediate software-force event for PWM1A

0: No effect

1: Trigger a force event

(R/W)

MCPWM_GEN1_A_NCIFORCE_MODE Configures non-continuous immediate software force mode for PWM1A.

0: Disabled

1: Low

2: High

3: Disabled

(R/W)

Continued on the next page...

Register 35.34. MCPWM_GEN1_FORCE_REG (0x0084)

Continued from the previous page...

MCPWM_GEN1_B_NCIFORCE Configures whether or not to trigger a non-continuous immediate software-force event for PWM1B.

0: No effect

1: Trigger a force event

(R/W)

MCPWM_GEN1_B_NCIFORCE_MODE Configures non-continuous immediate software force mode for PWM1B. See details in [MCPWM_GEN1_A_NCIFORCE_MODE](#). (R/W)

Register 35.35. MCPWM_GEN1_A_REG (0x0088)

(reserved)								MCPWM_GEN1_A_DT1	MCPWM_GEN1_A_DT0	MCPWM_GEN1_A_DTEB	MCPWM_GEN1_A_DTEA	MCPWM_GEN1_A_DTEP	MCPWM_GEN1_A_DTEZ	MCPWM_GEN1_A_UT1	MCPWM_GEN1_A_UT0	MCPWM_GEN1_A_UTEA	MCPWM_GEN1_A_UTEB	MCPWM_GEN1_A_UTEA	MCPWM_GEN1_A_UTEZ							
31	24	23	22	21	20	19	18	17	16	15	14	13	12	11	10	9	8	7	6	5	4	3	2	1	0	Reset
0	0	0	0	0	0	0	0	0	0	0	0	0	0	0	0	0	0	0	0	0	0	0	0	0	0	

MCPWM_GEN1_A_UTEZ Configures action on PWM1A triggered by event TEZ when timer increasing.

0: No change

1: Low

2: High

3: Toggle

(R/W)

MCPWM_GEN1_A_UTEA Configures action on PWM1A triggered by event TEA when timer increasing. See details in [MCPWM_GEN1_A_UTEZ](#). (R/W)

MCPWM_GEN1_A_UTEB Configures action on PWM1A triggered by event TEB when timer increasing. See details in [MCPWM_GEN1_A_UTEZ](#). (R/W)

MCPWM_GEN1_A_UT0 Configures action on PWM1A triggered by event_t0 when timer increasing. See details in [MCPWM_GEN1_A_UTEZ](#). (R/W)

MCPWM_GEN1_A_UT1 Configures action on PWM1A triggered by event_t1 when timer increasing. See details in [MCPWM_GEN1_A_UTEZ](#). (R/W)

MCPWM_GEN1_A_DTEZ Configures action on PWM1A triggered by event TEZ when timer decreasing. See details in [MCPWM_GEN1_A_UTEZ](#). (R/W)

MCPWM_GEN1_A_DTEA Configures action on PWM1A triggered by event TEA when timer decreasing. See details in [MCPWM_GEN1_A_UTEZ](#). (R/W)

MCPWM_GEN1_A_DTEB Configures action on PWM1A triggered by event TEB when timer decreasing. See details in [MCPWM_GEN1_A_UTEZ](#). (R/W)

MCPWM_GEN1_A_DT0 Configures action on PWM1A triggered by event_t0 when timer decreasing. See details in [MCPWM_GEN1_A_UTEZ](#). (R/W)

MCPWM_GEN1_A_DT1 Configures action on PWM1A triggered by event_t1 when timer decreasing. See details in [MCPWM_GEN1_A_UTEZ](#). (R/W)

Register 35.36. MCPWM_GEN1_B_REG (0x008C)

(reserved)								MCPWM_GEN1_B_DT1	MCPWM_GEN1_B_DT0	MCPWM_GEN1_B_DTEB	MCPWM_GEN1_B_DTEA	MCPWM_GEN1_B_DTEP	MCPWM_GEN1_B_DTEZ	MCPWM_GEN1_B_UT1	MCPWM_GEN1_B_UT0	MCPWM_GEN1_B_UTEA	MCPWM_GEN1_B_UTEB	MCPWM_GEN1_B_UTEA	MCPWM_GEN1_B_UTEZ							
31	24	23	22	21	20	19	18	17	16	15	14	13	12	11	10	9	8	7	6	5	4	3	2	1	0	
0	0	0	0	0	0	0	0	0	0	0	0	0	0	0	0	0	0	0	0	0	0	0	0	0	0	Reset

MCPWM_GEN1_B_UTEZ Configures the action on PWM1B triggered by event TEZ when timer increasing.

0: No change

1: Low

2: High

3: Toggle

(R/W)

MCPWM_GEN1_B_UTEA Configures action on PWM1B triggered by event TEA when timer increasing. See details in [MCPWM_GEN1_B_UTEZ](#). (R/W)

MCPWM_GEN1_B_UTEB Configures action on PWM1B triggered by event TEB when timer increasing. See details in [MCPWM_GEN1_B_UTEZ](#). (R/W)

MCPWM_GEN1_B_UT0 Configures action on PWM1B triggered by event_t0 when timer increasing. See details in [MCPWM_GEN1_B_UTEZ](#). (R/W)

MCPWM_GEN1_B_UT1 Configures action on PWM1B triggered by event_t1 when timer increasing. See details in [MCPWM_GEN1_B_UTEZ](#). (R/W)

MCPWM_GEN1_B_DTEZ Configures action on PWM1B triggered by event TEZ when timer decreasing. See details in [MCPWM_GEN1_B_UTEZ](#). (R/W)

MCPWM_GEN1_B_DTEA Configures action on PWM1B triggered by event TEA when timer decreasing. See details in [MCPWM_GEN1_B_UTEZ](#). (R/W)

MCPWM_GEN1_B_DTEB Configures action on PWM1B triggered by event TEB when timer decreasing. See details in [MCPWM_GEN1_B_UTEZ](#). (R/W)

MCPWM_GEN1_B_DT0 Configures action on PWM1B triggered by event_t0 when timer decreasing. See details in [MCPWM_GEN1_B_UTEZ](#). (R/W)

MCPWM_GEN1_B_DT1 Configures action on PWM1B triggered by event_t1 when timer decreasing. See details in [MCPWM_GEN1_B_UTEZ](#). (R/W)

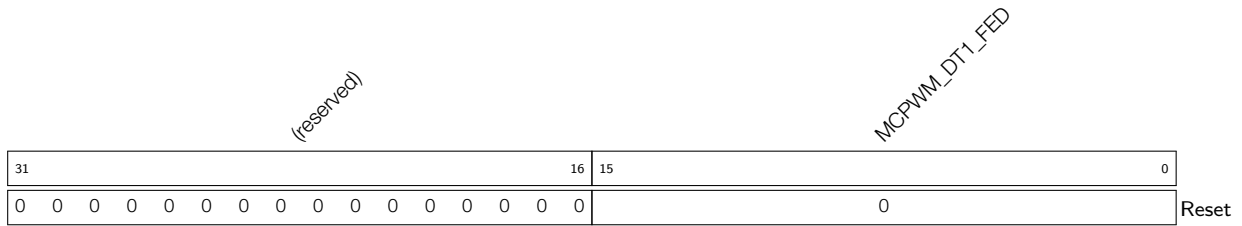
Register 35.38. MCPWM_DT1_FED_CFG_REG (0x0094)

MCPWM_DT1_FED Shadow register for FED. (R/W)

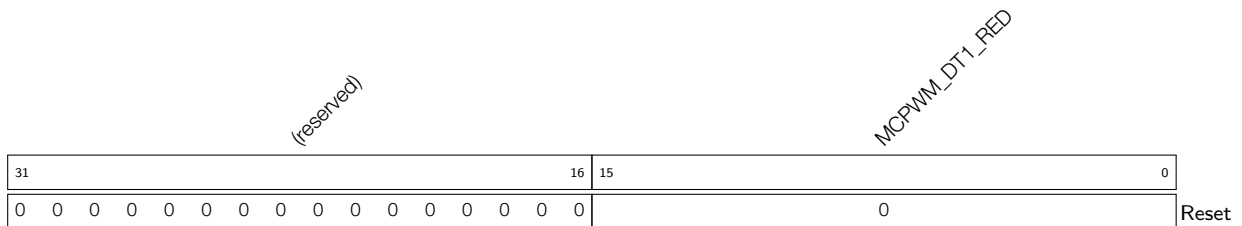
Register 35.39. MCPWM_DT1_RED_CFG_REG (0x0098)

MCPWM_DT1_RED Shadow register for RED. (R/W)

Register 35.40. MCPWM_CARRIER1_CFG_REG (0x009C)

(reserved)														MCPWM_CARRIER1_IN_INVERT		MCPWM_CARRIER1_OUT_INVERT		MCPWM_CARRIER1_OSHTWTH		MCPWM_CARRIER1_DUTY		MCPWM_CARRIER1_PRESCALE		MCPWM_CARRIER1_EN						
31															14	13	12	11			8	7			5	4			1	0
0 0 0 0 0 0 0 0 0 0 0 0 0 0														0	0	0		0	0	0		0	0	Reset						

MCPWM_CARRIER1_EN Configures whether or not to enable carrier1 function.

0: Bypass carrier1

1: Enable carrier1 function

(R/W)

MCPWM_CARRIER1_PRESCALE Configures the PWM carrier1 clock (PC_CLK) prescale value. Period of PC_CLK = period of PWM_CLK * (PWM_CARRIER0_PRESCALE + 1). (R/W)

MCPWM_CARRIER1_DUTY Configures carrier duty selection. Duty = PWM_CARRIER0_DUTY/8. (R/W)

MCPWM_CARRIER1_OSHTWTH Configures width of the first pulse in number of periods of the carrier. (R/W)

MCPWM_CARRIER1_OUT_INVERT Configures whether or not to invert the output of PWM1A and PWM1B for this submodule.

0: No effect

1: Invert

(R/W)

MCPWM_CARRIER1_IN_INVERT Configures whether or not to invert the input of PWM1A and PWM1B for this submodule.

0: No effect

1: Invert

(R/W)

Register 35.41. MCPWM_FH1_CFG0_REG (0x00A0)

(reserved)	MCPWM_FH1_B_OST_U	MCPWM_FH1_B_OST_D	MCPWM_FH1_B_CBC_U	MCPWM_FH1_B_CBC_D	MCPWM_FH1_A_OST_U	MCPWM_FH1_A_OST_D	MCPWM_FH1_A_CBC_U	MCPWM_FH1_A_CBC_D	MCPWM_FH1_F0_OST	MCPWM_FH1_F1_OST	MCPWM_FH1_F2_OST	MCPWM_FH1_SW_OST	MCPWM_FH1_F0_CBC	MCPWM_FH1_F1_CBC	MCPWM_FH1_F2_CBC	MCPWM_FH1_SW_CBC											
31	24	23	22	21	20	19	18	17	16	15	14	13	12	11	10	9	8	7	6	5	4	3	2	1	0	Reset	
0	0	0	0	0	0	0	0	0	0	0	0	0	0	0	0	0	0	0	0	0	0	0	0	0	0	0	0

MCPWM_FH1_SW_CBC Configures whether or not to enable software force cycle-by-cycle mode action.

0: Disable

1: Enable

(R/W)

MCPWM_FH1_F2_CBC Configures whether or not fault_event2 will trigger cycle-by-cycle mode action.

0: Disable

1: Enable

(R/W)

MCPWM_FH1_F1_CBC Configures whether or not fault_event1 will trigger cycle-by-cycle mode action. See details in [MCPWM_FH1_F2_CBC](#). (R/W)

MCPWM_FH1_F0_CBC Configures whether or not fault_event0 will trigger cycle-by-cycle mode action. See details in [MCPWM_FH1_F2_CBC](#). (R/W)

MCPWM_FH1_SW_OST Configures whether or not to enable register for software force one-shot mode action. See details in [MCPWM_FH1_SW_CBC](#). (R/W)

MCPWM_FH1_F2_OST Configures whether or not fault_event2 will trigger one-shot mode action. See details in [MCPWM_FH1_F2_CBC](#). (R/W)

MCPWM_FH1_F1_OST Configures whether or not fault_event1 will trigger one-shot mode action. See details in [MCPWM_FH1_F2_CBC](#). (R/W)

MCPWM_FH1_F0_OST Configures whether or not fault_event0 will trigger one-shot mode action. See details in [MCPWM_FH1_F2_CBC](#). (R/W)

MCPWM_FH1_A_CBC_D Configures cycle-by-cycle mode action on PWM1A when fault event occurs and timer is decreasing.

0: Do nothing

1: Force low

2: Force high

3: Toggle

(R/W)

MCPWM_FH1_A_CBC_U Configures cycle-by-cycle mode action on PWM1A when fault event occurs and timer is increasing. See details in [MCPWM_FH1_F2_CBC](#). (R/W)

Continued on the next page...

Register 35.41. MCPWM_FH1_CFG0_REG (0x00A0)

Continued from the previous page...

MCPWM_FH1_A_OST_D Configures one-shot mode action on PWM1A when fault event occurs and timer is decreasing. See details in [MCPWM_FH1_F2_CBC](#). (R/W)

MCPWM_FH1_A_OST_U Configures one-shot mode action on PWM1A when fault event occurs and timer is increasing. See details in [MCPWM_FH1_F2_CBC](#). (R/W)

MCPWM_FH1_B_CBC_D Configures cycle-by-cycle mode action on PWM1B when fault event occurs and timer is decreasing. See details in [MCPWM_FH1_F2_CBC](#). (R/W)

MCPWM_FH1_B_CBC_U Configures cycle-by-cycle mode action on PWM1B when fault event occurs and timer is increasing. See details in [MCPWM_FH1_F2_CBC](#). (R/W)

MCPWM_FH1_B_OST_D Configures one-shot mode action on PWM1B when fault event occurs and timer is decreasing. See details in [MCPWM_FH1_F2_CBC](#). (R/W)

MCPWM_FH1_B_OST_U Configures one-shot mode action on PWM1B when fault event occurs and timer is increasing. See details in [MCPWM_FH1_F2_CBC](#). (R/W)

Register 35.44. MCPWM_GEN2_STMP_CFG_REG (0x00AC)

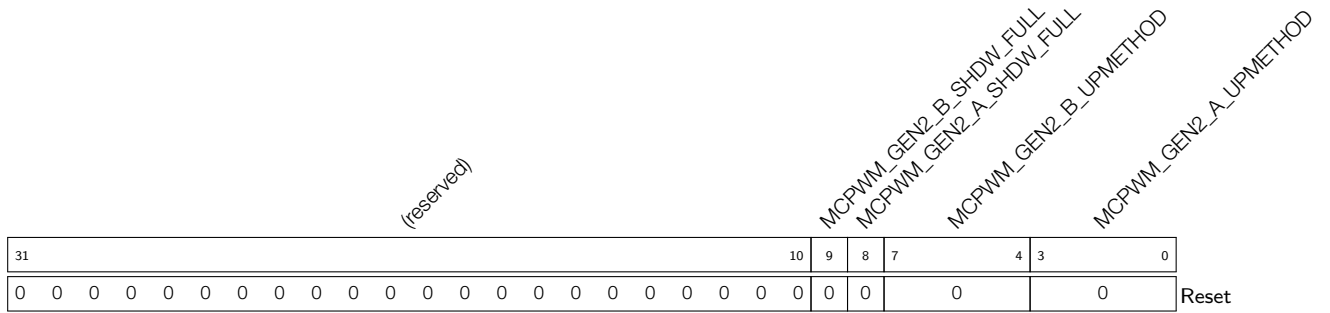

MCPWM_GEN2_A_UPMETHOD Configures update method for PWM generator 2 time stamp A's active register.

When all bits are set to 0: immediately.

When bit0 is set to 1: TEZ

When bit1 is set to 1: TEP

When bit2 is set to 1: sync

When bit3 is set to 1: disable the update

(R/W)

MCPWM_GEN2_B_UPMETHOD Configures update method for PWM generator 2 time stamp B's active register. See details in [MCPWM_GEN2_A_UPMETHOD](#). (R/W)

MCPWM_GEN2_A_SHDW_FULL Set and reset by hardware.

0: A's active reg has been updated with shadow register latest value.

1: PWM generator 2 time stamp A's shadow reg is filled and waiting to be transferred to A's active reg.

(R/SC/WTC)

MCPWM_GEN2_B_SHDW_FULL Set and reset by hardware.

0: B's active reg has been updated with shadow register latest value.

1: PWM generator 2 time stamp B's shadow reg is filled and waiting to be transferred to B's active reg.

(R/SC/WTC)

Register 35.45. MCPWM_GEN2_TSTMP_A_REG (0x00B0)

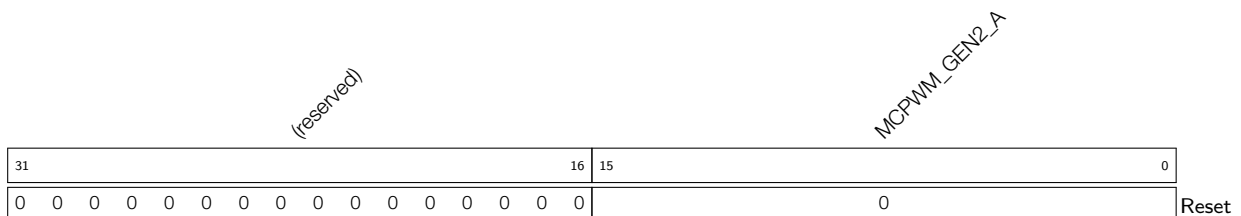

MCPWM_GEN2_A Shadow register for PWM generator 2 time stamp A. (R/W)

Register 35.46. MCPWM_GEN2_TSTMP_B_REG (0x00B4)

(reserved)															MCPWM_GEN2_B																
31															16	15															0
0 0 0 0 0 0 0 0 0 0 0 0 0 0 0 0															0																Reset

MCPWM_GEN2_B Shadow register for PWM generator 2 time stamp B. (R/W)

Register 35.47. MCPWM_GEN2_CFG0_REG (0x00B8)

(reserved)																			MCPWM_GEN2_T1_SEL	MCPWM_GEN2_T0_SEL	MCPWM_GEN2_CFG_UPMETHOD
31											10	9	7	6	4	3			0		
0 0 0 0 0 0 0 0 0 0										0	0	0	0				0	Reset			

MCPWM_GEN2_CFG_UPMETHOD Configures update method for PWM generator 2's active register.

0: Immediately

When bit0 is set to 1: TEZ

When bit1 is set to 1: sync

When bit3 is set to 1: disable the update

(R/W)

MCPWM_GEN2_T0_SEL Source selection for PWM generator 2 event_t0, take effect immediately.

0: fault_event0

1: fault_event1

2: fault_event2

3: sync_taken

4: None

(R/W)

MCPWM_GEN2_T1_SEL Source selection for PWM generator 2 event_t1, take effect immediately.

0: fault_event0

1: fault_event1

2: fault_event2

3: sync_taken

4: None

(R/W)

Register 35.48. MCPWM_GEN2_FORCE_REG (0x00BC)

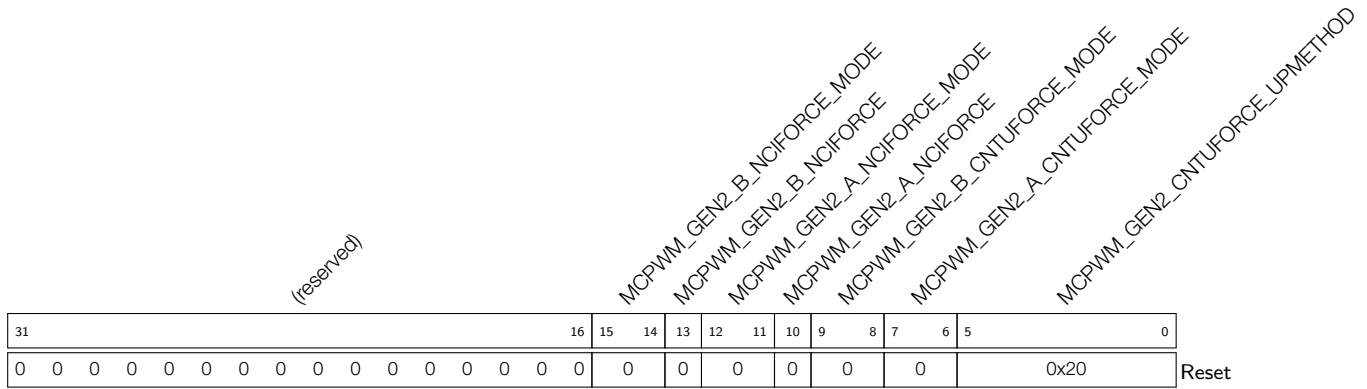

MCPWM_GEN2_CNTUFORCE_UPMETHOD Configures updating method for continuous software force of PWM generator 2. When all bits are set to 0: Immediately.
 When bit0 is set to 1: TEZ
 When bit1 is set to 1: TEP
 When bit2 is set to 1: TEA
 When bit3 is set to 1: TEB
 When bit4 is set to 1: Sync
 When bit5 is set to 1: Disable update
 TEA/B here and below means an event generated when the timer's value equals to that of register A/B.
 (R/W)

MCPWM_GEN2_A_CNTUFORCE_MODE Configures continuous software force mode for PWM2A.
 0: Disabled
 1: Low
 2: High
 3: Disabled
 (R/W)

MCPWM_GEN2_B_CNTUFORCE_MODE Configures continuous software force mode for PWM2B.
 0: Disabled
 1: Low
 2: High
 3: Disabled
 (R/W)

MCPWM_GEN2_A_NCIFORCE Configures whether or not to trigger a non-continuous immediate software-force event for PWM2A.
 0: No effect
 1: Trigger a force event
 (R/W)

Continued on the next page...

Register 35.48. MCPWM_GEN2_FORCE_REG (0x00BC)

Continued from the previous page...

MCPWM_GEN2_A_NCIFORCE_MODE Configures non-continuous immediate software force mode for PWM2A.

0: Disabled

1: Low

2: High

3: Disabled

(R/W)

MCPWM_GEN2_B_NCIFORCE Configures whether or not to trigger a non-continuous immediate software-force event for PWM2B.

0: No effect

1: Trigger a force event

(R/W)

MCPWM_GEN2_B_NCIFORCE_MODE Configures non-continuous immediate software force mode for PWM2B. See details in [MCPWM_GEN2_A_NCIFORCE_MODE](#). (R/W)

Register 35.49. MCPWM_GEN2_A_REG (0x00C0)

(reserved)								MCPWM_GEN2_A_DT1		MCPWM_GEN2_A_DT0		MCPWM_GEN2_A_DTEB		MCPWM_GEN2_A_DTEA		MCPWM_GEN2_A_DTEP		MCPWM_GEN2_A_DTEZ		MCPWM_GEN2_A_UT1		MCPWM_GEN2_A_UT0		MCPWM_GEN2_A_UTEA		MCPWM_GEN2_A_UTEA		MCPWM_GEN2_A_UTEZ					
31							24	23	22	21	20	19	18	17	16	15	14	13	12	11	10	9	8	7	6	5	4	3	2	1	0		
0	0	0	0	0	0	0	0	0	0	0	0	0	0	0	0	0	0	0	0	0	0	0	0	0	0	0	0	0	0	0	0	0	0

Reset

MCPWM_GEN2_A_UTEZ Action on PWM2A triggered by event TEZ when timer increasing.

0: No change

1: Low.

2: High.

3: Toggle

(R/W)

MCPWM_GEN2_A_UTEA Action on PWM2A triggered by event TEA when timer increasing. (R/W)

MCPWM_GEN2_A_UTEA Action on PWM2A triggered by event TEA when timer increasing. (R/W)

MCPWM_GEN2_A_UTEA Action on PWM2A triggered by event TEA when timer increasing. (R/W)

MCPWM_GEN2_A_UTEA Action on PWM2A triggered by event TEA when timer increasing. (R/W)

MCPWM_GEN2_A_UTEA Action on PWM2A triggered by event TEA when timer increasing. (R/W)

MCPWM_GEN2_A_UTEA Action on PWM2A triggered by event TEA when timer increasing. (R/W)

MCPWM_GEN2_A_UTEA Action on PWM2A triggered by event TEA when timer increasing. (R/W)

MCPWM_GEN2_A_UTEA Action on PWM2A triggered by event TEA when timer increasing. (R/W)

MCPWM_GEN2_A_UTEA Action on PWM2A triggered by event TEA when timer increasing. (R/W)

MCPWM_GEN2_A_UTEA Action on PWM2A triggered by event TEA when timer increasing. (R/W)

MCPWM_GEN2_A_UTEA Action on PWM2A triggered by event TEA when timer increasing. (R/W)

Register 35.50. MCPWM_GEN2_B_REG (0x00C4)

(reserved)								MCPWM_GEN2_B_DT1	MCPWM_GEN2_B_DT0	MCPWM_GEN2_B_DTEB	MCPWM_GEN2_B_DTEA	MCPWM_GEN2_B_DTEP	MCPWM_GEN2_B_DTEZ	MCPWM_GEN2_B_UT1	MCPWM_GEN2_B_UT0	MCPWM_GEN2_B_UTEB	MCPWM_GEN2_B_UTEA	MCPWM_GEN2_B_UTEP	MCPWM_GEN2_B_UTEZ							
31	24	23	22	21	20	19	18	17	16	15	14	13	12	11	10	9	8	7	6	5	4	3	2	1	0	Reset
0	0	0	0	0	0	0	0	0	0	0	0	0	0	0	0	0	0	0	0	0	0	0	0	0	0	Reset

MCPWM_GEN2_B_UTEZ Action on PWM2B triggered by event TEZ when timer increasing.

0: No change

1: Low

2: High

3: Toggle

(R/W)

MCPWM_GEN2_B_UTEP Action on PWM2B triggered by event TEP when timer increasing. (R/W)

MCPWM_GEN2_B_UTEA Action on PWM2B triggered by event TEA when timer increasing. (R/W)

MCPWM_GEN2_B_UTEB Action on PWM2B triggered by event TEB when timer increasing. (R/W)

MCPWM_GEN2_B_UT0 Action on PWM2B triggered by event_t0 when timer increasing. (R/W)

MCPWM_GEN2_B_UT1 Action on PWM2B triggered by event_t1 when timer increasing. (R/W)

MCPWM_GEN2_B_DTEZ Action on PWM2B triggered by event TEZ when timer decreasing. (R/W)

MCPWM_GEN2_B_DTEP Action on PWM2B triggered by event TEP when timer decreasing. (R/W)

MCPWM_GEN2_B_DTEA Action on PWM2B triggered by event TEA when timer decreasing. (R/W)

MCPWM_GEN2_B_DTEB Action on PWM2B triggered by event TEB when timer decreasing. (R/W)

MCPWM_GEN2_B_DT0 Action on PWM2B triggered by event_t0 when timer decreasing. (R/W)

MCPWM_GEN2_B_DT1 Action on PWM2B triggered by event_t1 when timer decreasing. (R/W)

Register 35.52. MCPWM_DT2_FED_CFG_REG (0x00CC)

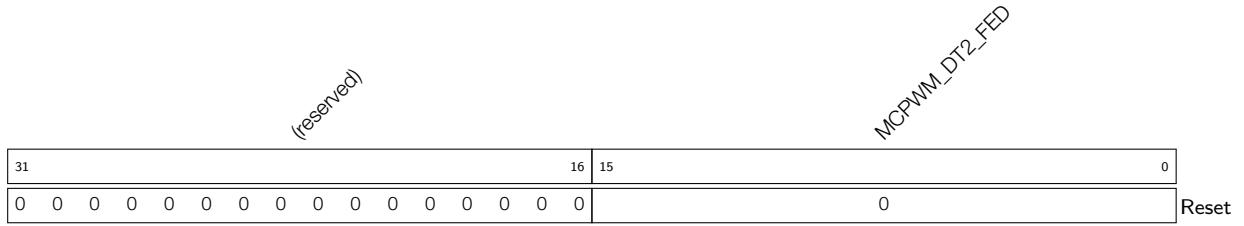

MCPWM_DT2_FED Shadow register for FED. (R/W)

Register 35.53. MCPWM_DT2_RED_CFG_REG (0x00D0)

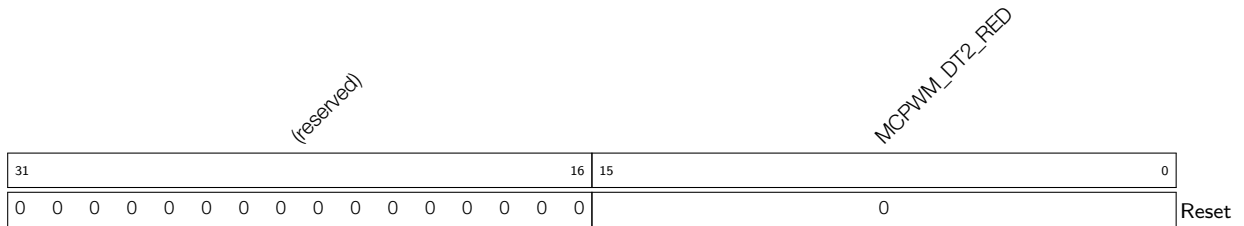

MCPWM_DT2_RED Shadow register for RED. (R/W)

Register 35.54. MCPWM_CARRIER2_CFG_REG (0x00D4)

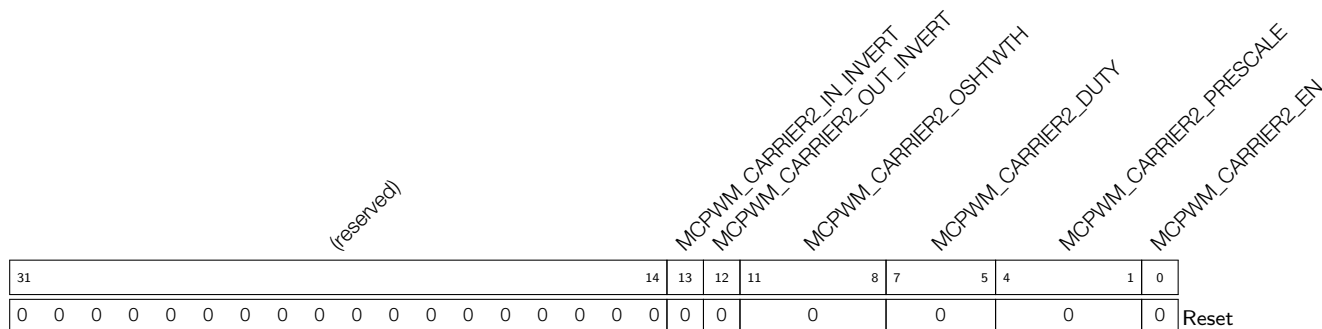

MCPWM_CARRIER2_EN Configures whether or not to enable the carrier2 function.

0: Bypass carrier2

1: Enable

(R/W)

MCPWM_CARRIER2_PRESCALE Configures the PWM carrier2 clock (PC_CLK) prescale value. Period of PC_CLK = period of PWM_CLK * (PWM_CARRIER0_PRESCALE + 1). (R/W)

MCPWM_CARRIER2_DUTY Configures the carrier duty selection. Duty = PWM_CARRIER0_DUTY/8. (R/W)

MCPWM_CARRIER2_OSHTWTH Configures the width of the first pulse in number of periods of the carrier. (R/W)

MCPWM_CARRIER2_OUT_INVERT Configures whether or not to invert the output of PWM2A and PWM2B for this submodule.

0: No effect

1: Invert

(R/W)

MCPWM_CARRIER2_IN_INVERT Configures whether or not to invert the input of PWM2A and PWM2B for this submodule.

0: No effect

1: Invert

(R/W)

Register 35.55. MCPWM_FH2_CFG0_REG (0x00D8)

(reserved)				MCPWM_FH2_B_OST_U		MCPWM_FH2_B_OST_D		MCPWM_FH2_B_CBC_U		MCPWM_FH2_B_CBC_D		MCPWM_FH2_A_OST_U		MCPWM_FH2_A_OST_D		MCPWM_FH2_A_CBC_U		MCPWM_FH2_A_CBC_D		MCPWM_FH2_F0_OST		MCPWM_FH2_F1_OST		MCPWM_FH2_F2_OST		MCPWM_FH2_SW_OST		MCPWM_FH2_F0_CBC		MCPWM_FH2_F1_CBC		MCPWM_FH2_F2_CBC		MCPWM_FH2_SW_CBC			
31	24	23	22	21	20	19	18	17	16	15	14	13	12	11	10	9	8	7	6	5	4	3	2	1	0												
0	0	0	0	0	0	0	0	0	0	0	0	0	0	0	0	0	0	0	0	0	0	0	0	0	0	0	0	0	0	0	0	0	0	0	0	0	Reset

MCPWM_FH2_SW_CBC Configures whether or not to enable software force cycle-by-cycle mode action.

0: Disable

1: Enable

(R/W)

MCPWM_FH2_F2_CBC Configures whether or not fault_event2 will trigger cycle-by-cycle mode action.

0: No effect

1: Trigger

(R/W)

MCPWM_FH2_F1_CBC Configures whether or not fault_event1 will trigger cycle-by-cycle mode action.

0: No effect

1: Trigger

(R/W)

MCPWM_FH2_F0_CBC Configures whether or not fault_event0 will trigger cycle-by-cycle mode action.

0: No effect

1: Trigger

(R/W)

MCPWM_FH2_SW_OST Configures whether or not to enable software force one-shot mode action.

0: Disable

1: Enable

(R/W)

MCPWM_FH2_F2_OST Configures whether or not fault_event2 will trigger one-shot mode action.

0: No effect

1: Trigger

(R/W) (R/W)

MCPWM_FH2_F1_OST Configures whether or not fault_event1 will trigger one-shot mode action.

0: No effect

1: Trigger

(R/W) (R/W)

Continued on the next page...

Register 35.55. MCPWM_FH2_CFG0_REG (0x00D8)

Continued from the previous page...

MCPWM_FH2_F0_OST Configures whether or not fault_event0 will trigger one-shot mode action.

0: No effect

1: Trigger

(R/W) (R/W)

MCPWM_FH2_A_CBC_D Configures cycle-by-cycle mode action on PWM2A when fault event occurs and timer is decreasing.

0: Do nothing.

1: Force low.

2: Force high.

3: Toggle

(R/W)

MCPWM_FH2_A_CBC_U Configures cycle-by-cycle mode action on PWM2A when fault event occurs and the timer is increasing. See details in [MCPWM_FH2_A_CBC_D](#). (R/W)

MCPWM_FH2_A_OST_D Configures one-shot mode action on PWM2A when fault event occurs and timer is decreasing. See details in [MCPWM_FH2_A_CBC_D](#). (R/W)

MCPWM_FH2_A_OST_U Configures one-shot mode action on PWM2A when fault event occurs and timer is increasing. See details in [MCPWM_FH2_A_CBC_D](#). (R/W)

MCPWM_FH2_B_CBC_D Configures cycle-by-cycle mode action on PWM2B when fault event occurs and timer is decreasing. See details in [MCPWM_FH2_A_CBC_D](#). (R/W)

MCPWM_FH2_B_CBC_U Configures cycle-by-cycle mode action on PWM2B when fault event occurs and timer is increasing. See details in [MCPWM_FH2_A_CBC_D](#). (R/W)

MCPWM_FH2_B_OST_D Configures one-shot mode action on PWM2B when fault event occurs and timer is decreasing. See details in [MCPWM_FH2_A_CBC_D](#). (R/W)

MCPWM_FH2_B_OST_U Configures one-shot mode action on PWM2B when fault event occurs and timer is increasing. See details in [MCPWM_FH2_A_CBC_D](#). (R/W)

Register 35.58. MCPWM_FAULT_DETECT_REG (0x00E4)

(reserved)										MCPWM_EVENT_F2 MCPWM_EVENT_F1 MCPWM_EVENT_F0 MCPWM_F2_POLE MCPWM_F1_POLE MCPWM_F0_POLE MCPWM_F2_EN MCPWM_F1_EN MCPWM_F0_EN																			
31																				9	8	7	6	5	4	3	2	1	0
0										0										Reset									

MCPWM_F0_EN Configures whether or not to enable fault_event0 generation.

0: No effect

1: Enable

(R/W)

MCPWM_F1_EN Configures whether or not to enable fault_event1 generation.

0: No effect

1: Enable

(R/W)

MCPWM_F2_EN Configures whether or not to enable fault_event2 generation.

0: No effect

1: Enable

(R/W)

MCPWM_F0_POLE Configures fault_event0 trigger polarity on FAULT0 source from GPIO matrix.

0: Level low

1: Level high

(R/W)

MCPWM_F1_POLE Configures fault_event1 trigger polarity on FAULT1 source from GPIO matrix.

0: Level low

1: Level high

(R/W)

MCPWM_F2_POLE Configures fault_event2 trigger polarity on FAULT2 source from GPIO matrix.

0: Level low

1: Level high

(R/W)

MCPWM_EVENT_F0 Represents set and reset by hardware. If set, fault_event0 is on going. (RO)

MCPWM_EVENT_F1 Represents set and reset by hardware. If set, fault_event1 is on going. (RO)

MCPWM_EVENT_F2 Represents set and reset by hardware. If set, fault_event2 is on going. (RO)

Register 35.61. MCPWM_CAP_CH0_CFG_REG (0x00F0)

(reserved)													MCPWM_CAP0_SW	MCPWM_CAP0_IN_INVERT	MCPWM_CAP0_PRESCALE	MCPWM_CAP0_MODE	MCPWM_CAP0_EN							
31												13	12	11	10				3	2	1	0		
0 0 0 0 0 0 0 0 0 0 0 0 0 0 0 0 0													0		0		0			0		0		Reset

MCPWM_CAP0_EN Configures whether or not to enable capture on channel 0.

0: Not enable

1: Enable

(R/W)

MCPWM_CAP0_MODE Configures the edge of capture on channel 0 after prescaling.

When bit0 is set to 1: enable capture on the falling edge.

When bit1 is set to 1: enable capture on the rising edge.

(R/W)

MCPWM_CAP0_PRESCALE Configures the prescale value on the rising edge of CAP0. Prescale value = PWM_CAP0_PRESCALE + 1. (R/W)

MCPWM_CAP0_IN_INVERT Configures whether or not to invert the CAP0 from GPIO matrix before prescale.

0: No effect

1: Invert

(R/W)

MCPWM_CAP0_SW Configures whether or not to trigger a software forced capture on channel 0.

0: Not trigger

1: Trigger

(WT)

Register 35.62. MCPWM_CAP_CH1_CFG_REG (0x00F4)

(reserved)														MCPWM_CAP1_SW		MCPWM_CAP1_IN_INVERT		MCPWM_CAP1_PRESCALE			MCPWM_CAP1_MODE		MCPWM_CAP1_EN	
31											13	12	11	10				3	2	1	0			
0 0														0					0		0		Reset	

MCPWM_CAP1_EN Configures whether or not to enable capture on channel 1.
 0: Not enable
 1: Enable
 (R/W)

MCPWM_CAP1_MODE Configures the edge of capture on channel 1 after prescaling.
 When bit0 is set to 1: enable capture on the falling edge.
 When bit1 is set to 1: enable capture on the rising edge.
 (R/W)

MCPWM_CAP1_PRESCALE COnfigures the value of prescaling on the rising edge of CAP1.
 Prescale value = PWM_CAP1_PRESCALE + 1. (R/W)

MCPWM_CAP1_IN_INVERT Configures whether or not to invert the CAP1 from GPIO matrix before prescale.
 0: No effect
 1: Invert
 (R/W)

MCPWM_CAP1_SW Configures whether or not to trigger a software forced capture on channel 1.
 0: Not trigger
 1: Trigger
 (WT)

Register 35.65. MCPWM_CAP_CH1_REG (0x0100)

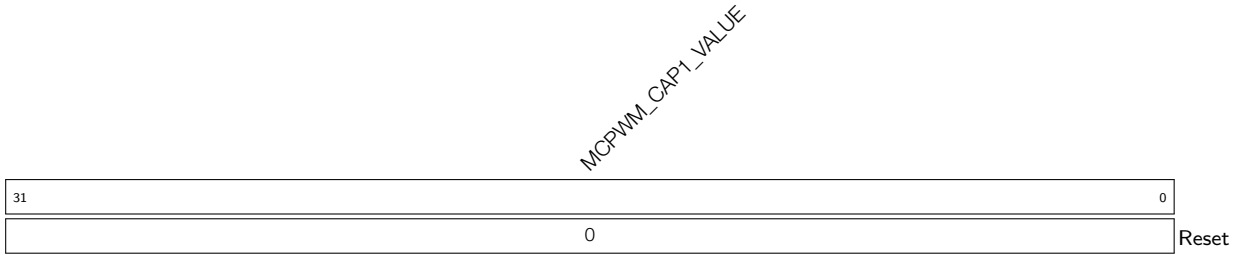

MCPWM_CAP1_VALUE Represents the value of the last capture on channel 1. (RO)

Register 35.66. MCPWM_CAP_CH2_REG (0x0104)

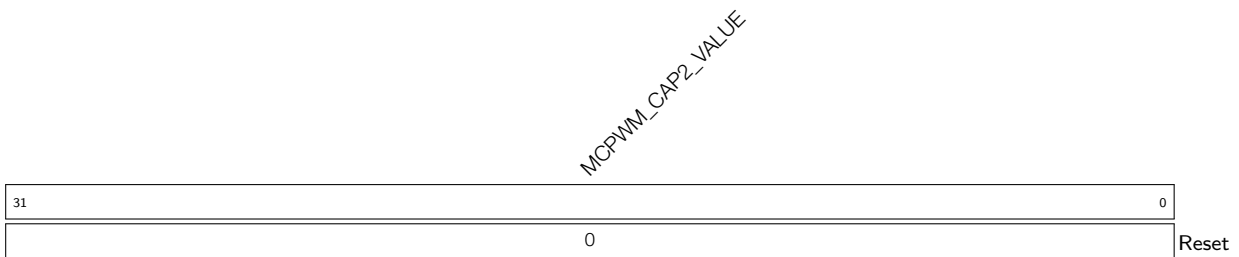

MCPWM_CAP2_VALUE Represents the value of the last capture on channel 2. (RO)

Register 35.67. MCPWM_CAP_STATUS_REG (0x0108)

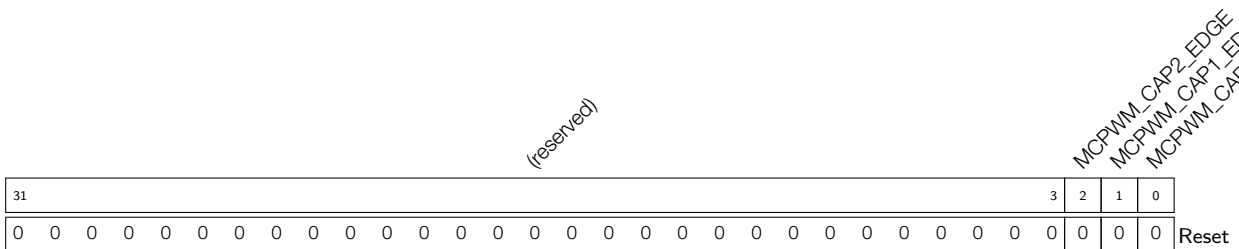

MCPWM_CAP0_EDGE Represents the edge of the last capture trigger on channel 0.

- 0: Rising edge
 - 1: Falling edge
- (RO)

MCPWM_CAP1_EDGE Represents the edge of the last capture trigger on channel 1. See details in [MCPWM_CAP0_EDGE](#). (RO)

MCPWM_CAP2_EDGE Represents the edge of the last capture trigger on channel 2. See details in [MCPWM_CAP0_EDGE](#). (RO)

Register 35.68. MCPWM_UPDATE_CFG_REG (0x010C)

(reserved)																MCPWM_OP2_FORCE_UP MCPWM_OP2_UP_EN MCPWM_OP1_FORCE_UP MCPWM_OP1_UP_EN MCPWM_OP0_FORCE_UP MCPWM_OP0_UP_EN MCPWM_GLOBAL_FORCE_UP MCPWM_GLOBAL_UP_EN										
31																8	7	6	5	4	3	2	1	0		
0																0	1	0	1	0	1	0	1	Reset		

MCPWM_GLOBAL_UP_EN Configures whether to globally update all active registers.

0: No effect

1: Update all active registers globally

(R/W)

MCPWM_GLOBAL_FORCE_UP Configures whether or not to trigger a forced update of all active registers globally.

0: No effect

1: Trigger a forced update

(R/W)

MCPWM_OP0_UP_EN Configures whether or not to update active registers in PWM operator 0 when [MCPWM_GLOBAL_UP_EN](#) is set to 1.

0: No effect

1: Update active registers in PWM operator 0

(R/W)

MCPWM_OP0_FORCE_UP Configures whether or not to trigger a forced update of active registers in PWM operator 0.

0: No effect

1: Trigger a forced update

(R/W)

MCPWM_OP1_UP_EN Configures whether or not to update active registers in PWM operator 1 when [MCPWM_GLOBAL_UP_EN](#) is set to 1.

0: No effect

1: Update active registers in PWM operator 1

(R/W)

Continued on the next page...

Register 35.68. MCPWM_UPDATE_CFG_REG (0x010C)

Continued from the previous page...

MCPWM_OP1_FORCE_UP Configures whether or not to trigger a forced update of active registers in PWM operator 1.

0: No effect

1: Trigger a forced update

(R/W)

MCPWM_OP2_UP_EN Configures whether or not to update active registers in PWM operator 2 when [MCPWM_GLOBAL_UP_EN](#) is set to 1.

0: No effect

1: Update active registers in PWM operator 2

(R/W)

MCPWM_OP2_FORCE_UP Configures whether or not to trigger a forced update of active registers in PWM operator 2.

0: No effect

1: Trigger a forced update

(R/W)

Register 35.69. MCPWM_INT_ENA_REG (0x0110)

<div style="display: flex; justify-content: space-between; font-size: 8px; transform: rotate(-45deg);"> (reserved) MCPWM_CAP2_INT_ENA MCPWM_CAP1_INT_ENA MCPWM_CAP0_INT_ENA MCPWM_TZ2_INT_ENA MCPWM_TZ1_INT_ENA MCPWM_TZ0_INT_ENA MCPWM_TZ2_OST_INT_ENA MCPWM_TZ1_OST_INT_ENA MCPWM_TZ0_OST_INT_ENA MCPWM_TZ1_CBC_INT_ENA MCPWM_TZ0_CBC_INT_ENA MCPWM_CMPR2_INT_ENA MCPWM_CMPR1_INT_ENA MCPWM_CMPR0_INT_ENA MCPWM_CMPR2_TEB_INT_ENA MCPWM_CMPR1_TEB_INT_ENA MCPWM_CMPR0_TEB_INT_ENA MCPWM_CMPR1_TEA_INT_ENA MCPWM_CMPR0_TEA_INT_ENA MCPWM_FAULT2_INT_ENA MCPWM_FAULT1_INT_ENA MCPWM_FAULT0_INT_ENA MCPWM_FAULT2_CLR_INT_ENA MCPWM_FAULT1_CLR_INT_ENA MCPWM_FAULT0_CLR_INT_ENA MCPWM_TIMER2_INT_ENA MCPWM_TIMER1_INT_ENA MCPWM_TIMER0_INT_ENA MCPWM_TIMER2_TEP_INT_ENA MCPWM_TIMER1_TEP_INT_ENA MCPWM_TIMER0_TEP_INT_ENA MCPWM_TIMER2_TEZ_INT_ENA MCPWM_TIMER1_TEZ_INT_ENA MCPWM_TIMER0_TEZ_INT_ENA MCPWM_TIMER2_STOP_INT_ENA MCPWM_TIMER1_STOP_INT_ENA MCPWM_TIMER0_STOP_INT_ENA </div>																															
31	30	29	28	27	26	25	24	23	22	21	20	19	18	17	16	15	14	13	12	11	10	9	8	7	6	5	4	3	2	1	0
0	0	0	0	0	0	0	0	0	0	0	0	0	0	0	0	0	0	0	0	0	0	0	0	0	0	0	0	0	0	0	0

Reset

MCPWM_TIMER0_STOP_INT_ENA Enables the interrupt triggered when the timer 0 stops. (R/W)

MCPWM_TIMER1_STOP_INT_ENA Enables the interrupt triggered when the timer 1 stops. (R/W)

MCPWM_TIMER2_STOP_INT_ENA Enables the interrupt triggered when the timer 2 stops. (R/W)

MCPWM_TIMER0_TEZ_INT_ENA Enables the interrupt triggered by a PWM timer 0 TEZ event. (R/W)

MCPWM_TIMER1_TEZ_INT_ENA Enables the interrupt triggered by a PWM timer 1 TEZ event. (R/W)

MCPWM_TIMER2_TEZ_INT_ENA Enables the interrupt triggered by a PWM timer 2 TEZ event. (R/W)

MCPWM_TIMER0_TEP_INT_ENA Enables the interrupt triggered by a PWM timer 0 TEP event. (R/W)

MCPWM_TIMER1_TEP_INT_ENA Enables the interrupt triggered by a PWM timer 1 TEP event. (R/W)

MCPWM_TIMER2_TEP_INT_ENA Enables the interrupt triggered by a PWM timer 2 TEP event. (R/W)

MCPWM_FAULT0_INT_ENA Enables the interrupt triggered when fault_event0 starts. (R/W)

MCPWM_FAULT1_INT_ENA Enables the interrupt triggered when fault_event1 starts. (R/W)

MCPWM_FAULT2_INT_ENA Enables the interrupt triggered when fault_event2 starts. (R/W)

MCPWM_FAULT0_CLR_INT_ENA Enables the interrupt triggered when fault_event0 ends. (R/W)

MCPWM_FAULT1_CLR_INT_ENA Enables the interrupt triggered when fault_event1 ends. (R/W)

MCPWM_FAULT2_CLR_INT_ENA Enables the interrupt triggered when fault_event2 ends. (R/W)

Continued on the next page...

Register 35.69. MCPWM_INT_ENA_REG (0x0110)

Continued from the previous page...

MCPWM_CMPR0_TEA_INT_ENA Enables the interrupt triggered by a PWM operator 0 TEA event (R/W)

MCPWM_CMPR1_TEA_INT_ENA Enables the interrupt triggered by a PWM operator 1 TEA event (R/W)

MCPWM_CMPR2_TEA_INT_ENA Enables the interrupt triggered by a PWM operator 2 TEA event (R/W)

MCPWM_CMPR0_TEB_INT_ENA Enables the interrupt triggered by a PWM operator 0 TEB event (R/W)

MCPWM_CMPR1_TEB_INT_ENA Enables the interrupt triggered by a PWM operator 1 TEB event (R/W)

MCPWM_CMPR2_TEB_INT_ENA Enables the interrupt triggered by a PWM operator 2 TEB event (R/W)

MCPWM_TZ0_CBC_INT_ENA Enables the interrupt triggered by a cycle-by-cycle mode action on PWM0. (R/W)

MCPWM_TZ1_CBC_INT_ENA Enables the interrupt triggered by a cycle-by-cycle mode action on PWM1. (R/W)

MCPWM_TZ2_CBC_INT_ENA Enables the interrupt triggered by a cycle-by-cycle mode action on PWM2. (R/W)

MCPWM_TZ0_OST_INT_ENA Enables the interrupt triggered by a one-shot mode action on PWM0. (R/W)

MCPWM_TZ1_OST_INT_ENA Enables the interrupt triggered by a one-shot mode action on PWM1. (R/W)

MCPWM_TZ2_OST_INT_ENA Enables the interrupt triggered by a one-shot mode action on PWM2. (R/W)

MCPWM_CAP0_INT_ENA Enables the interrupt triggered by capture on channel 0. (R/W)

MCPWM_CAP1_INT_ENA Enables the interrupt triggered by capture on channel 1. (R/W)

MCPWM_CAP2_INT_ENA Enables the interrupt triggered by capture on channel 2. (R/W)

Register 35.70. MCPWM_INT_RAW_REG (0x0114)

<div style="display: flex; justify-content: space-between;"> (reserved) MCPWM_CAP2_INT_RAW MCPWM_CAP1_INT_RAW MCPWM_CAP0_INT_RAW MCPWM_TZ2_OST_INT_RAW MCPWM_TZ1_OST_INT_RAW MCPWM_TZ2_CBC_INT_RAW MCPWM_TZ1_CBC_INT_RAW MCPWM_TZ0_CBC_INT_RAW MCPWM_CMPR2_TEB_INT_RAW MCPWM_CMPR1_TEB_INT_RAW MCPWM_CMPR0_TEB_INT_RAW MCPWM_CMPR2_TEA_INT_RAW MCPWM_CMPR1_TEA_INT_RAW MCPWM_CMPR0_TEA_INT_RAW MCPWM_FAULT2_CLR_INT_RAW MCPWM_FAULT1_CLR_INT_RAW MCPWM_FAULT0_CLR_INT_RAW MCPWM_TIMER2_TEP_INT_RAW MCPWM_TIMER1_TEP_INT_RAW MCPWM_TIMER0_TEP_INT_RAW MCPWM_TIMER2_TEZ_INT_RAW MCPWM_TIMER1_TEZ_INT_RAW MCPWM_TIMER0_TEZ_INT_RAW MCPWM_TIMER2_STOP_INT_RAW MCPWM_TIMER1_STOP_INT_RAW MCPWM_TIMER0_STOP_INT_RAW </div>																																
31	30	29	28	27	26	25	24	23	22	21	20	19	18	17	16	15	14	13	12	11	10	9	8	7	6	5	4	3	2	1	0	
0	0	0	0	0	0	0	0	0	0	0	0	0	0	0	0	0	0	0	0	0	0	0	0	0	0	0	0	0	0	0	0	0

Reset

MCPWM_TIMER0_STOP_INT_RAW Represents the raw status for the interrupt triggered when the timer 0 stops. (R/WTC/SS)

MCPWM_TIMER1_STOP_INT_RAW Represents the raw status for the interrupt triggered when the timer 1 stops. (R/WTC/SS)

MCPWM_TIMER2_STOP_INT_RAW Represents the raw status for the interrupt triggered when the timer 2 stops. (R/WTC/SS)

MCPWM_TIMER0_TEZ_INT_RAW Represents the raw status for the interrupt triggered by a PWM timer 0 TEZ event. (R/WTC/SS)

MCPWM_TIMER1_TEZ_INT_RAW Represents the raw status for the interrupt triggered by a PWM timer 1 TEZ event. (R/WTC/SS)

MCPWM_TIMER2_TEZ_INT_RAW Represents the raw status for the interrupt triggered by a PWM timer 2 TEZ event. (R/WTC/SS)

MCPWM_TIMER0_TEP_INT_RAW Represents the raw status for the interrupt triggered by a PWM timer 0 TEP event. (R/WTC/SS)

MCPWM_TIMER1_TEP_INT_RAW Represents the raw status for the interrupt triggered by a PWM timer 1 TEP event. (R/WTC/SS)

MCPWM_TIMER2_TEP_INT_RAW Represents the raw status for the interrupt triggered by a PWM timer 2 TEP event. (R/WTC/SS)

MCPWM_FAULT0_INT_RAW Represents the raw status for the interrupt triggered when fault_event0 starts. (R/WTC/SS)

MCPWM_FAULT1_INT_RAW Represents the raw status for the interrupt triggered when fault_event1 starts. (R/WTC/SS)

MCPWM_FAULT2_INT_RAW Represents the raw status for the interrupt triggered when fault_event2 starts. (R/WTC/SS)

MCPWM_FAULT0_CLR_INT_RAW Represents the raw status for the interrupt triggered when fault_event0 ends. (R/WTC/SS)

MCPWM_FAULT1_CLR_INT_RAW Represents the raw status for the interrupt triggered when fault_event1 ends. (R/WTC/SS)

Continued on the next page...

Register 35.70. MCPWM_INT_RAW_REG (0x0114)

Continued from the previous page...

MCPWM_FAULT2_CLR_INT_RAW Represents the raw status for the interrupt triggered when fault_event2 ends. (R/WTC/SS)

MCPWM_CMPR0_TEA_INT_RAW Represents the raw status for the interrupt triggered by a PWM operator 0 TEA event. (R/WTC/SS)

MCPWM_CMPR1_TEA_INT_RAW Represents the raw status for the interrupt triggered by a PWM operator 1 TEA event. (R/WTC/SS)

MCPWM_CMPR2_TEA_INT_RAW Represents the raw status for the interrupt triggered by a PWM operator 2 TEA event. (R/WTC/SS)

MCPWM_CMPR0_TEB_INT_RAW Represents the raw status for the interrupt triggered by a PWM operator 0 TEB event. (R/WTC/SS)

MCPWM_CMPR1_TEB_INT_RAW Represents the raw status for the interrupt triggered by a PWM operator 1 TEB event. (R/WTC/SS)

MCPWM_CMPR2_TEB_INT_RAW Represents the raw status for the interrupt triggered by a PWM operator 2 TEB event. (R/WTC/SS)

MCPWM_TZ0_CBC_INT_RAW Represents the raw status for the interrupt triggered by a cycle-by-cycle mode action on PWM0. (R/WTC/SS)

MCPWM_TZ1_CBC_INT_RAW Represents the raw status for the interrupt triggered by a cycle-by-cycle mode action on PWM1. (R/WTC/SS)

MCPWM_TZ2_CBC_INT_RAW Represents the raw status for the interrupt triggered by a cycle-by-cycle mode action on PWM2. (R/WTC/SS)

MCPWM_TZ0_OST_INT_RAW Represents the raw status for the interrupt triggered by a one-shot mode action on PWM0. (R/WTC/SS)

MCPWM_TZ1_OST_INT_RAW Represents the raw status for the interrupt triggered by a one-shot mode action on PWM1. (R/WTC/SS)

MCPWM_TZ2_OST_INT_RAW Represents the raw status for the interrupt triggered by a one-shot mode action on PWM2. (R/WTC/SS)

MCPWM_CAP0_INT_RAW Represents the raw status for the interrupt triggered by capture on channel 0. (R/WTC/SS)

MCPWM_CAP1_INT_RAW Represents the raw status for the interrupt triggered by capture on channel 1. (R/WTC/SS)

MCPWM_CAP2_INT_RAW Represents the raw status for the interrupt triggered by capture on channel 2. (R/WTC/SS)

Register 35.71. MCPWM_INT_ST_REG (0x0118)

<div style="display: flex; justify-content: space-between;"> <div style="writing-mode: vertical-rl; transform: rotate(180deg); font-size: small;">(reserved)</div> <div style="writing-mode: vertical-rl; transform: rotate(180deg); font-size: x-small;"> MCPWM_CAP2_INT_ST MCPWM_CAP1_INT_ST MCPWM_CAP0_INT_ST MCPWM_TZ2_OST_INT_ST MCPWM_TZ1_OST_INT_ST MCPWM_TZ0_OST_INT_ST MCPWM_TZ2_CBC_INT_ST MCPWM_TZ1_CBC_INT_ST MCPWM_TZ0_CBC_INT_ST MCPWM_CMPR2_TEB_INT_ST MCPWM_CMPR1_TEB_INT_ST MCPWM_CMPR0_TEB_INT_ST MCPWM_CMPR2_TEA_INT_ST MCPWM_CMPR1_TEA_INT_ST MCPWM_CMPR0_TEA_INT_ST MCPWM_FAULT2_CLR_INT_ST MCPWM_FAULT1_CLR_INT_ST MCPWM_FAULT0_CLR_INT_ST MCPWM_FAULT1_INT_ST MCPWM_FAULT0_INT_ST MCPWM_TIMER2_TEP_INT_ST MCPWM_TIMER1_TEP_INT_ST MCPWM_TIMER0_TEP_INT_ST MCPWM_TIMER2_TEZ_INT_ST MCPWM_TIMER1_TEZ_INT_ST MCPWM_TIMER0_TEZ_INT_ST MCPWM_TIMER2_STOP_INT_ST MCPWM_TIMER1_STOP_INT_ST MCPWM_TIMER0_STOP_INT_ST </div> </div>																																	
31	30	29	28	27	26	25	24	23	22	21	20	19	18	17	16	15	14	13	12	11	10	9	8	7	6	5	4	3	2	1	0	Reset	
0	0	0	0	0	0	0	0	0	0	0	0	0	0	0	0	0	0	0	0	0	0	0	0	0	0	0	0	0	0	0	0	0	0

MCPWM_TIMER0_STOP_INT_ST Represents the masked status for the interrupt triggered when the timer 0 stops. (RO)

MCPWM_TIMER1_STOP_INT_ST Represents the masked status for the interrupt triggered when the timer 1 stops. (RO)

MCPWM_TIMER2_STOP_INT_ST Represents the masked status for the interrupt triggered when the timer 2 stops. (RO)

MCPWM_TIMER0_TEZ_INT_ST Represents the masked status for the interrupt triggered by a PWM timer 0 TEZ event. (RO)

MCPWM_TIMER1_TEZ_INT_ST Represents the masked status for the interrupt triggered by a PWM timer 1 TEZ event. (RO)

MCPWM_TIMER2_TEZ_INT_ST Represents the masked status for the interrupt triggered by a PWM timer 2 TEZ event. (RO)

MCPWM_TIMER0_TEP_INT_ST Represents the masked status for the interrupt triggered by a PWM timer 0 TEP event. (RO)

MCPWM_TIMER1_TEP_INT_ST Represents the masked status for the interrupt triggered by a PWM timer 1 TEP event. (RO)

MCPWM_TIMER2_TEP_INT_ST Represents the masked status for the interrupt triggered by a PWM timer 2 TEP event. (RO)

MCPWM_FAULT0_INT_ST Represents the masked status for the interrupt triggered when fault_event0 starts. (RO)

MCPWM_FAULT1_INT_ST Represents the masked status for the interrupt triggered when fault_event1 starts. (RO)

MCPWM_FAULT2_INT_ST Represents the masked status for the interrupt triggered when fault_event2 starts. (RO)

MCPWM_FAULT0_CLR_INT_ST Represents the masked status for the interrupt triggered when fault_event0 ends. (RO)

MCPWM_FAULT1_CLR_INT_ST Represents the masked status for the interrupt triggered when fault_event1 ends. (RO)

Continued on the next page...

Register 35.71. MCPWM_INT_ST_REG (0x0118)

Continued from the previous page...

MCPWM_FAULT2_CLR_INT_ST Represents the masked status for the interrupt triggered when fault_event2 ends. (RO)

MCPWM_CMPR0_TEA_INT_ST Represents the masked status for the interrupt triggered by a PWM operator 0 TEA event. (RO)

MCPWM_CMPR1_TEA_INT_ST Represents the masked status for the interrupt triggered by a PWM operator 1 TEA event. (RO)

MCPWM_CMPR2_TEA_INT_ST Represents the masked status for the interrupt triggered by a PWM operator 2 TEA event. (RO)

MCPWM_CMPR0_TEB_INT_ST Represents the masked status for the interrupt triggered by a PWM operator 0 TEB event. (RO)

MCPWM_CMPR1_TEB_INT_ST Represents the masked status for the interrupt triggered by a PWM operator 1 TEB event. (RO)

MCPWM_CMPR2_TEB_INT_ST Represents the masked status for the interrupt triggered by a PWM operator 2 TEB event. (RO)

MCPWM_TZ0_CBC_INT_ST Represents the masked status for the interrupt triggered by a cycle-by-cycle mode action on PWM0. (RO)

MCPWM_TZ1_CBC_INT_ST Represents the masked status for the interrupt triggered by a cycle-by-cycle mode action on PWM1. (RO)

MCPWM_TZ2_CBC_INT_ST Represents the masked status for the interrupt triggered by a cycle-by-cycle mode action on PWM2. (RO)

MCPWM_TZ0_OST_INT_ST Represents the masked status for the interrupt triggered by a one-shot mode action on PWM0. (RO)

MCPWM_TZ1_OST_INT_ST Represents the masked status for the interrupt triggered by a one-shot mode action on PWM1. (RO)

MCPWM_TZ2_OST_INT_ST Represents the masked status for the interrupt triggered by a one-shot mode action on PWM2. (RO)

MCPWM_CAP0_INT_ST Represents the masked status for the interrupt triggered by capture on channel 0. (RO)

MCPWM_CAP1_INT_ST Represents the masked status for the interrupt triggered by capture on channel 1. (RO)

MCPWM_CAP2_INT_ST Represents the masked status for the interrupt triggered by capture on channel 2. (RO)

Register 35.72. MCPWM_INT_CLR_REG (0x011C)

(reserved)	MCPWM_CAP2_INT_CLR	MCPWM_CAP1_INT_CLR	MCPWM_CAP0_INT_CLR	MCPWM_TZ2_OST_CLR	MCPWM_TZ1_OST_CLR	MCPWM_TZ0_OST_CLR	MCPWM_TZ2_CBC_CLR	MCPWM_TZ1_CBC_CLR	MCPWM_TZ0_CBC_CLR	MCPWM_CMPR2_INT_CLR	MCPWM_CMPR1_INT_CLR	MCPWM_CMPR0_INT_CLR	MCPWM_CMPR2_TEB_INT_CLR	MCPWM_CMPR1_TEB_INT_CLR	MCPWM_CMPR0_TEB_INT_CLR	MCPWM_CMPR1_TEA_INT_CLR	MCPWM_CMPR0_TEA_INT_CLR	MCPWM_FAULT2_CLR_INT_CLR	MCPWM_FAULT1_CLR_INT_CLR	MCPWM_FAULT0_CLR_INT_CLR	MCPWM_FAULT1_INT_CLR	MCPWM_FAULT0_INT_CLR	MCPWM_TIMER2_TEP_INT_CLR	MCPWM_TIMER1_TEP_INT_CLR	MCPWM_TIMER0_TEP_INT_CLR	MCPWM_TIMER2_TEZ_INT_CLR	MCPWM_TIMER1_TEZ_INT_CLR	MCPWM_TIMER0_TEZ_INT_CLR	MCPWM_TIMER2_STOP_INT_CLR	MCPWM_TIMER1_STOP_INT_CLR	MCPWM_TIMER0_STOP_INT_CLR	
31	30	29	28	27	26	25	24	23	22	21	20	19	18	17	16	15	14	13	12	11	10	9	8	7	6	5	4	3	2	1	0	
0	0	0	0	0	0	0	0	0	0	0	0	0	0	0	0	0	0	0	0	0	0	0	0	0	0	0	0	0	0	0	0	Reset

MCPWM_TIMER0_STOP_INT_CLR Write 1 to clear the interrupt triggered when the timer 0 stops. (WT)

MCPWM_TIMER1_STOP_INT_CLR Write 1 to clear the interrupt triggered when the timer 1 stops. (WT)

MCPWM_TIMER2_STOP_INT_CLR Write 1 to clear the interrupt triggered when the timer 2 stops. (WT)

MCPWM_TIMER0_TEZ_INT_CLR Write 1 to clear the interrupt triggered by a PWM timer 0 TEZ event. (WT)

MCPWM_TIMER1_TEZ_INT_CLR Write 1 to clear the interrupt triggered by a PWM timer 1 TEZ event. (WT)

MCPWM_TIMER2_TEZ_INT_CLR Write 1 to clear the interrupt triggered by a PWM timer 2 TEZ event. (WT)

MCPWM_TIMER0_TEP_INT_CLR Write 1 to clear the interrupt triggered by a PWM timer 0 TEP event. (WT)

MCPWM_TIMER1_TEP_INT_CLR Write 1 to clear the interrupt triggered by a PWM timer 1 TEP event. (WT)

MCPWM_TIMER2_TEP_INT_CLR Write 1 to clear the interrupt triggered by a PWM timer 2 TEP event. (WT)

MCPWM_FAULT0_INT_CLR Write 1 to clear the interrupt triggered when fault_event0 starts. (WT)

MCPWM_FAULT1_INT_CLR Write 1 to clear the interrupt triggered when fault_event1 starts. (WT)

MCPWM_FAULT2_INT_CLR Write 1 to clear the interrupt triggered when fault_event2 starts. (WT)

MCPWM_FAULT0_CLR_INT_CLR Write 1 to clear the interrupt triggered when fault_event0 ends. (WT)

Continued on the next page...

Register 35.72. MCPWM_INT_CLR_REG (0x011C)

Continued from the previous page...

MCPWM_FAULT1_CLR_INT_CLR Write 1 to clear the interrupt triggered when fault_event1 ends. (WT)

MCPWM_FAULT2_CLR_INT_CLR Write 1 to clear the interrupt triggered when fault_event2 ends. (WT)

MCPWM_CMPR0_TEA_INT_CLR Write 1 to clear the interrupt triggered by a PWM operator 0 TEA event. (WT)

MCPWM_CMPR1_TEA_INT_CLR Write 1 to clear the interrupt triggered by a PWM operator 1 TEA event. (WT)

MCPWM_CMPR2_TEA_INT_CLR Write 1 to clear the interrupt triggered by a PWM operator 2 TEA event. (WT)

MCPWM_CMPR0_TEB_INT_CLR Write 1 to clear the interrupt triggered by a PWM operator 0 TEB event. (WT)

MCPWM_CMPR1_TEB_INT_CLR Write 1 to clear the interrupt triggered by a PWM operator 1 TEB event. (WT)

MCPWM_CMPR2_TEB_INT_CLR Write 1 to clear the interrupt triggered by a PWM operator 2 TEB event. (WT)

MCPWM_TZ0_CBC_INT_CLR Write 1 to clear the interrupt triggered by a cycle-by-cycle mode action on PWM0. (WT)

MCPWM_TZ1_CBC_INT_CLR Write 1 to clear the interrupt triggered by a cycle-by-cycle mode action on PWM1. (WT)

MCPWM_TZ2_CBC_INT_CLR Write 1 to clear the interrupt triggered by a cycle-by-cycle mode action on PWM2. (WT)

MCPWM_TZ0_OST_INT_CLR Write 1 to clear the interrupt triggered by a one-shot mode action on PWM0. (WT)

MCPWM_TZ1_OST_INT_CLR Write 1 to clear the interrupt triggered by a one-shot mode action on PWM1. (WT)

MCPWM_TZ2_OST_INT_CLR Write 1 to clear the interrupt triggered by a one-shot mode action on PWM2. (WT)

MCPWM_CAP0_INT_CLR Write 1 to clear the interrupt triggered by capture on channel 0. (WT)

MCPWM_CAP1_INT_CLR Write 1 to clear the interrupt triggered by capture on channel 1. (WT)

MCPWM_CAP2_INT_CLR Write 1 to clear the interrupt triggered by capture on channel 2. (WT)

Register 35.73. MCPWM_EVT_EN_REG (0x0120)

(reserved)	MCPWM_EVT_CAP2_EN	MCPWM_EVT_CAP1_EN	MCPWM_EVT_CAP0_EN	MCPWM_EVT_TZ2_OST_EN	MCPWM_EVT_TZ1_OST_EN	MCPWM_EVT_TZ0_OST_EN	MCPWM_EVT_TZ1_CBC_EN	MCPWM_EVT_TZ0_CBC_EN	MCPWM_EVT_TZ1_CLR_EN	MCPWM_EVT_TZ0_CLR_EN	MCPWM_EVT_F1_EN	MCPWM_EVT_F0_EN	MCPWM_EVT_OP2_TEB_EN	MCPWM_EVT_OP1_TEB_EN	MCPWM_EVT_OP2_TEA_EN	MCPWM_EVT_OP1_TEA_EN	MCPWM_EVT_TIMER2_TEP_EN	MCPWM_EVT_TIMER1_TEP_EN	MCPWM_EVT_TIMER0_TEP_EN	MCPWM_EVT_TIMER2_TEZ_EN	MCPWM_EVT_TIMER1_TEZ_EN	MCPWM_EVT_TIMER0_TEZ_EN	MCPWM_EVT_TIMER2_STOP_EN	MCPWM_EVT_TIMER1_STOP_EN	MCPWM_EVT_TIMER0_STOP_EN							
31	30	29	28	27	26	25	24	23	22	21	20	19	18	17	16	15	14	13	12	11	10	9	8	7	6	5	4	3	2	1	0	
0	0	0	0	0	0	0	0	0	0	0	0	0	0	0	0	0	0	0	0	0	0	0	0	0	0	0	0	0	0	0	0	Reset

MCPWM_EVT_TIMER0_STOP_EN Configures whether or not to enable timer0 stop event generation.
 0: Disable
 1: Enable
 (R/W)

MCPWM_EVT_TIMER1_STOP_EN Configures whether or not to enable timer1 stop event generation.
 0: Disable
 1: Enable
 (R/W)

MCPWM_EVT_TIMER2_STOP_EN Configures whether or not to enable timer2 stop event generation.
 0: Disable
 1: Enable
 (R/W)

MCPWM_EVT_TIMER0_TEZ_EN Configures whether or not to enable timer0 equal zero event generation.
 0: Disable
 1: Enable
 (R/W)

MCPWM_EVT_TIMER1_TEZ_EN Configures whether or not to enable timer1 equal zero event generation.
 0: Disable
 1: Enable
 (R/W)

MCPWM_EVT_TIMER2_TEZ_EN Configures whether or not to enable timer2 equal zero event generation.
 0: Disable
 1: Enable
 (R/W)

Continued on the next page...

Register 35.73. MCPWM_EVT_EN_REG (0x0120)

Continued from the previous page...

MCPWM_EVT_TIMER0_TEP_EN Configures whether or not to enable timer0 equal period event generation.

0: Disable

1: Enable

(R/W)

MCPWM_EVT_TIMER1_TEP_EN Configures whether or not to enable timer1 equal period event generation.

0: Disable

1: Enable

(R/W)

MCPWM_EVT_TIMER2_TEP_EN Configures whether or not to enable timer2 equal period event generation.

0: Disable

1: Enable

(R/W)

MCPWM_EVT_OPO_TEA_EN Configures whether or not to enable PWM generator0 timer equal A event generation.

0: Disable

1: Enable

(R/W)

MCPWM_EVT_OP1_TEA_EN Configures whether or not to enable PWM generator1 timer equal A event generation.

0: Disable

1: Enable

(R/W)

MCPWM_EVT_OP2_TEA_EN Configures whether or not to enable PWM generator2 timer equal A event generation.

0: Disable

1: Enable

(R/W)

MCPWM_EVT_OPO_TEB_EN Configures whether or not to enable PWM generator0 timer equal B event generation.

0: Disable

1: Enable

(R/W)

Continued on the next page...

Register 35.73. MCPWM_EVT_EN_REG (0x0120)

Continued from the previous page...

MCPWM_EVT_OP1_TEB_EN Configures whether or not to enable PWM generator1 timer equal B event generation.

0: Disable

1: Enable

(R/W)

MCPWM_EVT_OP2_TEB_EN Configures whether or not to enable PWM generator2 timer equal B event generation.

0: Disable

1: Enable

(R/W)

MCPWM_EVT_F0_EN Configures whether or not to enable FAULT0 event generation.

0: Disable

1: Enable

(R/W)

MCPWM_EVT_F1_EN Configures whether or not to enable FAULT1 event generation.

0: Disable

1: Enable

(R/W)

MCPWM_EVT_F2_EN Configures whether or not to enable FAULT2 event generation.

0: Disable

1: Enable

(R/W)

MCPWM_EVT_F0_CLR_EN Configures whether or not to enable FAULT0 clear event generation.

0: Disable

1: Enable

(R/W)

MCPWM_EVT_F1_CLR_EN Configures whether or not to enable FAULT1 clear event generation.

0: Disable

1: Enable

(R/W)

MCPWM_EVT_F2_CLR_EN Configures whether or not to enable FAULT2 clear event generation.

0: Disable

1: Enable

(R/W)

Continued on the next page...

Register 35.73. MCPWM_EVT_EN_REG (0x0120)

Continued from the previous page...

MCPWM_EVT_TZ0_CBC_EN Configures whether or not to enable cycle by cycle trip0 event generation.

0: Disable

1: Enable

(R/W)

MCPWM_EVT_TZ1_CBC_EN Configures whether or not to enable cycle by cycle trip1 event generation.

0: Disable

1: Enable

(R/W)

MCPWM_EVT_TZ2_CBC_EN Configures whether or not to enable cycle by cycle trip2 event generation.

0: Disable

1: Enable

(R/W)

MCPWM_EVT_TZ0_OST_EN Configures whether or not to enable one shot trip0 event generation.

0: Disable

1: Enable

(R/W)

MCPWM_EVT_TZ1_OST_EN Configures whether or not to enable one shot trip1 event generation.

0: Disable

1: Enable

(R/W)

MCPWM_EVT_TZ2_OST_EN Configures whether or not to enable one shot trip2 event generation.

0: Disable

1: Enable

(R/W)

MCPWM_EVT_CAP0_EN Configures whether or not to enable capture0 event generation.

0: Disable

1: Enable

(R/W)

MCPWM_EVT_CAP1_EN Configures whether or not to enable capture1 event generation.

0: Disable

1: Enable

(R/W)

MCPWM_EVT_CAP2_EN Configures whether or not to enable capture2 event generation.

0: Disable

1: Enable

(R/W)

Register 35.74. MCPWM_TASK_EN_REG (0x0124)

(reserved)																						MCPWM_TASK_CAP2_EN	MCPWM_TASK_CAP1_EN	MCPWM_TASK_CAP0_EN	MCPWM_TASK_CLR2_EN	MCPWM_TASK_CLR1_EN	MCPWM_TASK_CLR0_EN	MCPWM_TASK_TZ2_EN	MCPWM_TASK_TZ1_EN	MCPWM_TASK_TZ0_EN	MCPWM_TASK_TIMER2_EN	MCPWM_TASK_TIMER1_EN	MCPWM_TASK_TIMER0_EN	MCPWM_TASK_SYNC2_EN	MCPWM_TASK_SYNC1_EN	MCPWM_TASK_SYNC0_EN	MCPWM_TASK_STOP2_EN	MCPWM_TASK_STOP1_EN	MCPWM_TASK_STOP0_EN	MCPWM_TASK_CMPR2_B_UP_EN	MCPWM_TASK_CMPR1_B_UP_EN	MCPWM_TASK_CMPR2_A_UP_EN	MCPWM_TASK_CMPR1_A_UP_EN	MCPWM_TASK_CMPR0_A_UP_EN	MCPWM_TASK_CMPR0_B_UP_EN
31	22	21	20	19	18	17	16	15	14	13	12	11	10	9	8	7	6	5	4	3	2	1	0	Reset																					
0	0	0	0	0	0	0	0	0	0	0	0	0	0	0	0	0	0	0	0	0	0	0	0	0	0	0																			

MCPWM_TASK_CMPR0_A_UP_EN Configures whether or not to receive update task of PWM generator0 timer stamp A's shadow register.
 0: No effect
 1: Receive
 (R/W)

MCPWM_TASK_CMPR1_A_UP_EN Configures whether or not to receive update task of PWM generator1 timer stamp A's shadow register.
 0: No effect
 1: Receive
 (R/W)

MCPWM_TASK_CMPR2_A_UP_EN Configures whether or not to receive update task of PWM generator2 timer stamp A's shadow register.
 0: No effect
 1: Receive
 (R/W)

MCPWM_TASK_CMPR0_B_UP_EN Configures whether or not to receive update task of PWM generator0 timer stamp B's shadow register.
 0: No effect
 1: Receive
 (R/W)

MCPWM_TASK_CMPR1_B_UP_EN Configures whether or not to receive update task of PWM generator1 timer stamp B's shadow register.
 0: No effect
 1: Receive
 (R/W)

MCPWM_TASK_CMPR2_B_UP_EN Configures whether or not to receive update task of PWM generator2 timer stamp B's shadow register.
 0: No effect
 1: Receive
 (R/W)

Continued on the next page...

Register 35.74. MCPWM_TASK_EN_REG (0x0124)

Continued from the previous page...

MCPWM_TASK_GEN_STOP_EN Configures whether or not to receive all PWM generate stop task.

0: No effect

1: Receive

(R/W)

MCPWM_TASK_TIMER0_SYNC_EN Configures whether or not to receive timer0 sync task.

0: No effect

1: Receive

(R/W)

MCPWM_TASK_TIMER1_SYNC_EN Configures whether or not to receive timer1 sync task.

0: No effect

1: Receive

(R/W)

MCPWM_TASK_TIMER2_SYNC_EN Configures whether or not to receive timer2 sync task.

0: No effect

1: Receive

(R/W)

MCPWM_TASK_TIMER0_PERIOD_UP_EN Configures whether or not to receive timer0 period update task.

0: No effect

1: Receive

(R/W)

MCPWM_TASK_TIMER1_PERIOD_UP_EN Configures whether or not to receive timer1 period update task.

0: No effect

1: Receive

(R/W)

MCPWM_TASK_TIMER2_PERIOD_UP_EN Configures whether or not to receive timer2 period update task.

0: No effect

1: Receive

(R/W)

Continued on the next page...

Register 35.74. MCPWM_TASK_EN_REG (0x0124)

Continued from the previous page...

MCPWM_TASK_TZ0_OST_EN Configures whether or not to receive one shot trip0 task.

0: No effect

1: Receive

(R/W)

MCPWM_TASK_TZ1_OST_EN Configures whether or not to receive one shot trip1 task.

0: No effect

1: Receive

(R/W)

MCPWM_TASK_TZ2_OST_EN Configures whether or not to receive one shot trip2 task.

0: No effect

1: Receive

(R/W)

MCPWM_TASK_CLR0_OST_EN Configures whether or not to receive one shot trip0 clear task.

0: No effect

1: Receive

(R/W)

MCPWM_TASK_CLR1_OST_EN Configures whether or not to receive one shot trip1 clear task.

0: No effect

1: Receive

(R/W)

MCPWM_TASK_CLR2_OST_EN Configures whether or not to receive one shot trip2 clear task.

0: No effect

1: Receive

(R/W)

MCPWM_TASK_CAP0_EN Configures whether or not to receive capture0 task.

0: No effect

1: Receive

(R/W)

MCPWM_TASK_CAP1_EN Configures whether or not to receive capture1 task.

0: No effect

1: Receive

(R/W)

MCPWM_TASK_CAP2_EN Configures whether or not to receive capture2 task.

0: No effect

1: Receive

(R/W)

Register 35.75. MCPWM_CLK_REG (0x0128)

31	<i>(reserved)</i>																												1	0	Reset
0 0																														0	

MCPWM_CLK_EN Configures whether or not to force the clock on.

0: No effect

1: Force the clock on

(R/W)

Register 35.76. MCPWM_VERSION_REG (0x012C)

31	<i>(reserved)</i>			28	<i>MCPWM_DATE</i>																				27	0	Reset
0 0 0 0				0x2201240																							

MCPWM_DATE Version control register. (R/W)

36 Remote Control Peripheral (RMT)

36.1 Overview

The RMT (Remote Control) module is designed to send and receive infrared remote control signals. A variety of remote control protocols can be encoded/decoded via software based on the RMT module. The RMT module converts pulse codes stored in the module's built-in RAM into output signals, or converts input signals into pulse codes and stores them in RAM. In addition, the RMT module optionally modulates its output signals with a carrier wave, or optionally demodulates and filters its input signals.

The RMT module has four channels, numbered from zero to three. Each channel is able to independently transmit or receive signals.

- Channels 0 ~ 1 (TX channel) are dedicated to transmitting signals;
- Channels 2 ~ 3 (RX channel) are dedicated to receiving signals.

Each TX/RX channel has the same functionality controlled by a dedicated set of registers and is able to independently transmit or receive data. TX channels are indicated by *n* which is used as a placeholder for the channel number, and by *m* for RX channels.

36.2 Features

The RMT module has the following features:

- Four channels:
 - Two TX channels
 - Two RX channels
 - Four channels share a 192 x 32-bit RAM
- The transmitter supports:
 - Normal TX mode
 - Wrap TX mode
 - Continuous TX mode
 - Modulation on TX pulses
 - Multiple channels (programmable) transmitting data simultaneously
- The receiver supports:
 - Normal RX mode
 - Wrap RX mode
 - RX filtering
 - Demodulation on RX pulses

36.3 Functional Description

36.3.1 RMT Architecture

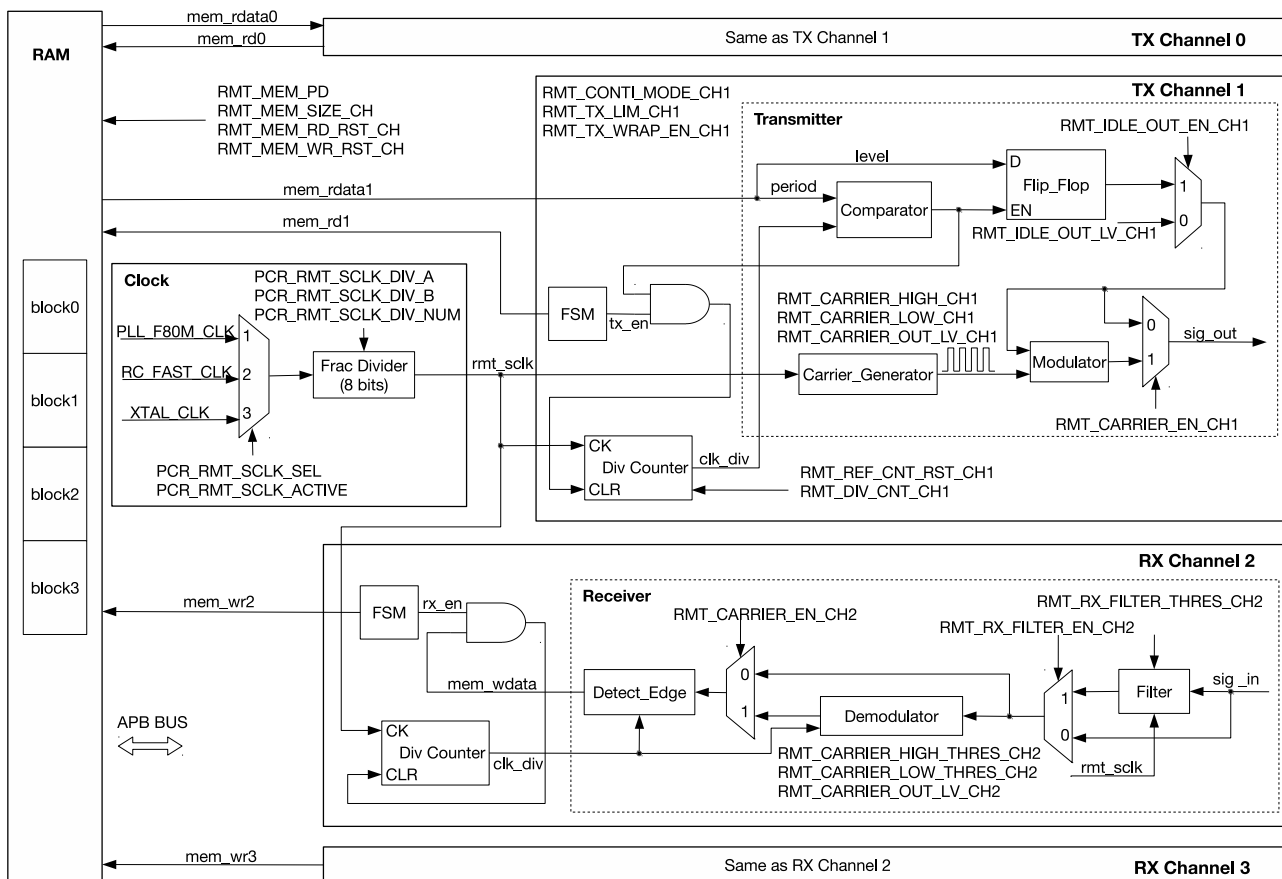

Figure 36-1. RMT Architecture

As shown in Figure 36-1, each TX channel has:

- 1 x clock divider counter (Div Counter)
- 1 x state machine (FSM)
- 1 x transmitter

Each RX channel also has:

- 1 x clock divider counter (Div Counter)
- 1 x state machine (FSM)
- 1 x receiver

The four channels share a 192 x 32-bit RAM.

36.3.2 RMT RAM

36.3.2.1 Structure of RAM

Figure 36-2 shows the format of pulse code in RAM. Each pulse code contains a 16-bit entry with two fields: “level” and “period”. “level” (0 or 1) indicates a low-/high-level value that was received or is going to be sent, while “period” points out the number of clock cycles (see `clk_div` in Figure 36-1) that the level lasts for.

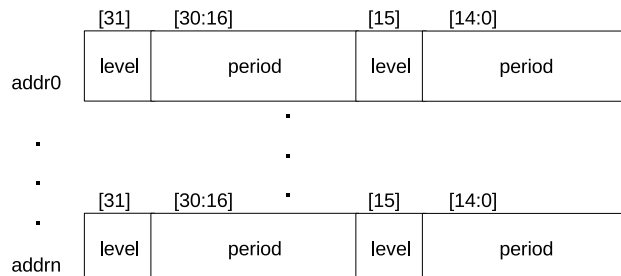

Figure 36-2. Format of Pulse Code in RAM

The minimum value for the period is zero (0) and is interpreted as a transmission end-marker. For a non-zero period (i.e., not an end-marker), its value is limited by APB clock and RMT clock according to the equation below:

$$3 \times T_{apb_clk} + 5 \times T_{rmt_sclk} < period \times T_{clk_div} \quad (1)$$

36.3.2.2 Use of RAM

The RAM is divided into four 48 x 32-bit blocks. By default, each channel uses one block (block 0 for channel 0, block 1 for channel 1, and so on).

If the data size of one single transfer is larger than the block size of TX channel n or RX channel m , users can configure the channel:

- to enable [wrap mode](#) by setting `RMT_MEM_TX/RX_WRAP_EN_CHn/m`;
- or to use more blocks by configuring `RMT_MEM_SIZE_CHn/m`.

Setting `RMT_MEM_SIZE_CHn/m > 1` allows channel n/m to use the memory of the subsequent channels, i.e., block $(n/m) \sim$ block $(n/m + RMT_MEM_SIZE_CHn/m - 1)$. In such case, the subsequent channels $n/m + 1 \sim n/m + RMT_MEM_SIZE_CHn/m - 1$ can not be used since their RAM blocks are occupied. For example, if channel 0 is configured to use block 0 and block 1, then channel 1 will be unavailable since its block is occupied, while channel 2 and channel 3 are not affected and can be used normally.

Note that the RAM used by each channel is mapped from low address to high address. In such mode, channel 0 is able to use the RAM blocks of channels 1, 2, and 3 by setting `RMT_MEM_SIZE_CH0`, but channel 3 can not use the blocks of channels 0, 1, or 2. Therefore, the maximum value of `RMT_MEM_SIZE_CHn` should not exceed $(4 - n)$ and the maximum value of `RMT_MEM_SIZE_CHm` should not exceed $(2 - m)$.

The RMT RAM can be accessed via APB bus, or read by the transmitter and written by the receiver. To avoid any possible access conflict between the receiver writing RAM and the APB bus reading RAM, RMT can be

configured to designate the RAM block's owner, be it the receiver or the APB bus, by configuring `RMT_MEM_OWNER_CH m` . If this ownership is violated, a flag signal `RMT_MEM_OWNER_ERR_CH m` will be generated.

When the RMT module is inactive, the RAM can be put into low-power mode by setting `RMT_MEM_FORCE_PD`.

36.3.2.3 RAM Access

APB bus is able to access RAM in FIFO mode and in NONFIFO (Direct Address) mode, depending on the configuration of `RMT_APB_FIFO_MASK`:

- 0: use FIFO mode;
- 1: use NONFIFO mode.

FIFO Mode

In FIFO mode, the APB reads data from or writes data to RAM via a fixed address stored in `RMT_CH n /mDATA_REG`.

NONFIFO Mode

In NONFIFO mode, the APB writes data to or reads data from a continuous address range.

- The write-starting address of TX channel n is: RMT base address + $0x400 + (n - 1) \times 48$. The access address for the second data and the following data are RMT base address + $0x400 + (n - 1) \times 48 + 0x4$, and so on, incremented by $0x4$.
- The read-starting address of RX channel m is: RMT base address + $0x460 + (m - 1) \times 48$. The access address for the second data and the following data are RMT base address + $0x460 + (m - 1) \times 48 + 0x4$, and so on, incremented by $0x4$.

36.3.3 Clock

The clock source of RMT can be `PLL_F80M_CLK`, `RC_FAST_CLK`, or `XTAL_CLK`, depending on the configuration of `PCR_RMT_SCLK_SEL`. RMT clock can be enabled by setting `PCR_RMT_SCLK_ACTIVE`. RMT working clock (see `rmt_sclk` in Figure 36-1) is obtained by dividing the selected clock source with a fractional divider. The divider is:

$$PCR_RMT_SCLK_DIV_NUM + 1 + PCR_RMT_SCLK_DIV_A/PCR_RMT_SCLK_DIV_B$$

For more information, see Chapter 8 *Reset and Clock*. `RMT_DIV_CNT_CH n /m` is used to configure the divider coefficient of internal clock divider for RMT channels. The coefficient is normally equal to the value of `RMT_DIV_CNT_CH n /m`, except for value 0 that represents divider 256. The clock divider can be reset by setting `RMT_REF_CNT_RST_CH n /m`. The clock generated from the divider can be used by the counter (see Figure 36-1).

36.3.4 Transmitter

Note:

Updating the configuration described in this and subsequent sections requires to set `RMT_CONF_UPDATE_CH n /m` first.

See Section 36.3.6.

36.3.4.1 Normal TX Mode

When `RMT_TX_START_CH n` is set, the transmitter of channel n starts reading and sending pulse codes from the starting address of its RAM block. The codes are sent starting from low-address entry. When an end-marker (a zero period) is encountered, the transmitter stops the transmission, returns to idle state, and generates an `RMT_CH n _TX_END_INT` interrupt. Setting `RMT_TX_STOP_CH n` to 1 also stops the transmission and immediately sets the transmitter back to idle. The output level of a transmitter in idle state is determined by the “level” field of the end-marker or by the content of `RMT_IDLE_OUT_LV_CH n` , depending on the configuration of `RMT_IDLE_OUT_EN_CH n` :

- 0: the level in idle state is determined by the “level” field of the end-marker;
- 1: the level is determined by `RMT_IDLE_OUT_LV_CH n` .

36.3.4.2 Wrap TX Mode

To transmit more pulse codes than can be fitted in the channel's RAM, users can enable wrap TX mode for channel n by setting `RMT_MEM_TX_WRAP_EN_CH n` . In this mode, the transmitter sends the data from RAM in loops till an end-marker is encountered. For example, if `RMT_MEM_SIZE_CH n` = 1, the transmitter starts sending data from the address $48 * n$, and then the data from higher RAM address. Once the transmitter finishes sending the data from $(48 * (n + 1) - 1)$, it continues sending data from $48 * n$ again till an end-marker is encountered. Wrap mode is also applicable for `RMT_MEM_SIZE_CH n` > 1.

When the size of transmitted pulse codes is larger than or equal to the value set by `RMT_TX_LIM_CH n` , an `RMT_CH n _TX_THR_EVENT_INT` interrupt is triggered. In wrap mode, `RMT_TX_LIM_CH n` can be set to a half or a fraction of the size of the channel's RAM block. When an `RMT_CH n _TX_THR_EVENT_INT` interrupt is detected by software, the already used RAM region can be updated by new pulse codes. In such way, the transmitter can seamlessly send unlimited pulse codes in wrap mode.

36.3.4.3 TX Modulation

Transmitter output can be modulated with a carrier wave by setting `RMT_CARRIER_EN_CH n` . The carrier waveform is configurable. In a carrier cycle, high level lasts for $(RMT_CARRIER_HIGH_CH n + 1)$ `rmt_sclk` cycles, while low level lasts for $(RMT_CARRIER_LOW_CH n + 1)$ `rmt_sclk` cycles. When `RMT_CARRIER_OUT_LV_CH n` is set, carrier wave is added on the high-level of output signals; while `RMT_CARRIER_OUT_LV_CH n` is cleared, carrier wave is added on the low-level of output signals. Carrier wave can be added on all output signals during modulation, or just added on valid pulse codes (the data stored in RAM), which can be set by configuring `RMT_CARRIER_EFF_EN_CH n` :

- 0: add carrier wave on all output signals;
- 1: add carrier wave only on valid signals.

36.3.4.4 Continuous TX Mode

The continuous TX mode can be enabled by setting `RMT_TX_CONTI_MODE_CH n` . In this mode, the transmitter sends the pulse codes from RAM in loops:

- If an end-marker is encountered, the transmitter starts transmitting the first data of the channel's RAM again.
- If no end-marker is encountered, there are two possible situations. In normal TX mode (`RMT_MEM_TX_WRAP_EN_CHn = 0`), an error interrupt occurs because the RAM is empty without any data to transmit. In wrap TX mode (`RMT_MEM_TX_WRAP_EN_CHn = 1`), the transmitter starts transmitting the first data again after the last data is transmitted.

If `RMT_TX_LOOP_CNT_EN_CHn` is set, the loop counting is incremented by 1 each time an end-marker is encountered. If the counting reaches the value set by `RMT_TX_LOOP_NUM_CHn`, an `RMT_CHn_TX_LOOP_INT` interrupt is generated. If `RMT_LOOP_STOP_EN_CHn` is set, the transmission stops instantly after an `RMT_CHn_TX_LOOP_INT` interrupt is generated. Otherwise, the transmission continues. In an end-marker, if its `period[14:0]` is 0, then the period of the previous data must satisfy:

$$6 \times T_{apb_clk} + 12 \times T_{rmt_sclk} < period \times T_{clk_div} \quad (2)$$

The period of the other data only need to satisfy [relation \(1\)](#).

36.3.4.5 Simultaneous TX Mode

RMT module supports multiple channels transmitting data simultaneously. To use this function, follow the steps below:

1. Configure `RMT_TX_SIM_CHn` to choose which multiple channels are used to transmit data simultaneously;
2. Set `RMT_TX_SIM_EN` to enable this transmission mode;
3. Set `RMT_TX_START_CHn` for each selected channel to start data transmission.

The transmission starts once the final channel is configured. Due to hardware limitations, there is no guarantee that two channels can start sending data exactly at the same time. The interval between two channels starting transmitting data is within $3 \times T_{clk_div}$.

36.3.5 Receiver

36.3.5.1 Normal RX Mode

The receiver of channel *m* is controlled by `RMT_RX_EN_CHm`:

- 0: the receiver stops receiving data;
- 1: the receiver starts working.

When the receiver becomes active, it starts counting from the first edge of the signal, detecting signal levels and counting clock cycles the level lasts for. Each cycle count (period) is then written back to RAM together with the level information (level). When the receiver detects no change in a signal level for a number of clock cycles more than the value set by `RMT_IDLE_THRES_CHm`, the receiver stops receiving data, returns to idle state, and generates an `RMT_CHm_RX_END_INT` interrupt. Please note that `RMT_IDLE_THRES_CHm` should be configured to a maximum value according to your application, otherwise a valid received level may be mistaken as a level in idle state. If the RAM space of this RX channel is used up by the received data, the receiver stops receiving data, and an `RMT_CHn_ERR_INT` interrupt is triggered by RAM FULL event.

36.3.5.2 Wrap RX Mode

To receive more pulse codes than can be fitted in the channel's RAM, users can enable wrap mode for channel m by configuring `RMT_MEM_RX_WRAP_EN_CH m` . In wrap mode, the receiver stores the received data to RAM space of this channel in loops. The receiving ends when the receiver detects no change in a signal level for a number of clock cycles more than the value set by `RMT_IDLE_THRES_CH m` . The receiver returns to idle state and generates an `RMT_CH m _RX_END_INT` interrupt. For example, if `RMT_MEM_SIZE_CH m` is set to 1, the receiver starts receiving data and stores the data to address $48 * m$, and then to higher RAM address. When the receiver finishes storing the received data to $(48 * (m + 1) - 1)$, the receiver continues receiving data and storing data to the address $48 * m$ again, and the receiving ends when no change is detected on a signal level for more than `RMT_IDLE_THRES_CH m` clock cycles. Wrap mode is also applicable when `RMT_MEM_SIZE_CH m` > 1.

An `RMT_CH m _RX_THR_EVENT_INT` interrupt is generated when the size of received pulse codes is larger than or equal to the value set by `RMT_CH m _RX_LIM_REG`. In wrap mode, `RMT_CH m _RX_LIM_REG` can be set to a half or a fraction of the size of the channel's RAM block. When an `RMT_CH m _RX_THR_EVENT_INT` interrupt is detected, the already used RAM region can be updated by subsequent data.

36.3.5.3 RX Filtering

Users can enable the receiver to filter input signals by setting `RMT_RX_FILTER_EN_CH m` for channel m . The filter samples input signals continuously, and detects the signals which remain unchanged for a continuous `RMT_RX_FILTER_THRES_CH m` rmt_sclk cycles as valid. Otherwise, the signals will be detected as invalid. Only the valid signals can pass through the filter. The filter removes pulses with a length of less than `RMT_RX_FILTER_THRES_CH m` rmt_sclk cycles.

36.3.5.4 RX Demodulation

Users can enable RX demodulation on input signals or on filtered signals by setting `RMT_CARRIER_EN_CH m` . RX demodulation can be applied to high-level carrier wave or low-level carrier wave, depending on the configuration of `RMT_CARRIER_OUT_LV_CH m` :

- 0: demodulate low-level carrier wave;
- 1: demodulate high-level carrier wave.

Users can configure `RMT_CARRIER_HIGH_THRES_CH m` and `RMT_CARRIER_LOW_THRES_CH m` to set the thresholds to demodulate high-level carrier or low-level carrier. If the high-level of a signal lasts for less than `RMT_CARRIER_HIGH_THRES_CH m` clk_div cycles, or the low-level lasts for less than `RMT_CARRIER_LOW_THRES_CH m` clk_div cycles, the signal is detected as a carrier and is then filtered out.

36.3.6 Configuration Update

To update RMT registers configuration, please set `RMT_CONF_UPDATE_CH n/m` for each channel first.

All the bits/fields listed in the second column of Table 36-1 should follow this rule.

Table 36-1. Configuration Update

Register	Bit/Field Configuration Update
TX Channel	
RMT_CH n CONF0_REG	RMT_CARRIER_OUT_LV_CH n
	RMT_CARRIER_EN_CH n
	RMT_CARRIER_EFF_EN_CH n
	RMT_DIV_CNT_CH n
	RMT_IDLE_OUT_EN_CH n
	RMT_IDLE_OUT_LV_CH n
	RMT_TX_CONTI_MODE_CH n
RMT_CH n CARRIER_DUTY_REG	RMT_CARRIER_HIGH_CH n
	RMT_CARRIER_LOW_CH n
RMT_CH n _TX_LIM_REG	RMT_TX_LOOP_CNT_EN_CH n
	RMT_TX_LOOP_NUM_CH n
	RMT_TX_LIM_CH n
RMT_TX_SIM_REG	RMT_TX_SIM_EN
RX Channel	
RMT_CH m CONF0_REG	RMT_CARRIER_OUT_LV_CH m
	RMT_CARRIER_EN_CH m
	RMT_IDLE_THRES_CH m
	RMT_DIV_CNT_CH m
RMT_CH m CONF1_REG	RMT_RX_FILTER_THRES_CH m
	RMT_RX_EN_CH m
RMT_CH m _RX_CARRIER_RM_REG	RMT_CARRIER_HIGH_THRES_CH m
	RMT_CARRIER_LOW_THRES_CH m
RMT_CH m _RX_LIM_REG	RMT_RX_LIM_CH m
RMT_REF_CNT_RST_REG	RMT_REF_CNT_RST_CH m

36.3.7 Interrupts

- RMT_CH n/m _ERR_INT: triggered when channel n/m does not read or write data correctly. For example, if the transmitter still tries to read data from RAM when the RAM is empty, or the receiver still tries to write data into RAM when the RAM is full, this interrupt will be triggered.
- RMT_CH n _TX_THR_EVENT_INT: triggered when the amount of data the transmitter has sent reaches the value set in RMT_CH n _TX_LIM_REG.
- RMT_CH m _RX_THR_EVENT_INT: triggered each time when the amount of data received by the receiver reaches the value set in RMT_CH m _RX_LIM_REG.
- RMT_CH n _TX_END_INT: triggered when the transmitter has finished transmitting signals.
- RMT_CH m _RX_END_INT: triggered when the receiver has finished receiving signals.
- RMT_CH n _TX_LOOP_INT: triggered when the loop counting reaches the value set by RMT_TX_LOOP_NUM_CH n .

36.4 Register Summary

The addresses in this section are relative to Remote Control Peripheral base address provided in Table 5-2 in Chapter 5 *System and Memory*.

The abbreviations given in Column **Access** are explained in Section *Access Types for Registers*.

Name	Description	Address	Access
FIFO R/W Registers			
RMT_CH0DATA_REG	The read and write data register for channel 0 by APB FIFO access.	0x0000	HRO
RMT_CH1DATA_REG	The read and write data register for channel 1 by APB FIFO access.	0x0004	HRO
RMT_CH2DATA_REG	The read and write data register for channel 2 by APB FIFO access.	0x0008	HRO
RMT_CH3DATA_REG	The read and write data register for channel 3 by APB FIFO access.	0x000C	HRO
Configuration Registers			
RMT_CH0CONF0_REG	Configuration register 0 for channel 0	0x0010	varies
RMT_CH1CONF0_REG	Configuration register 0 for channel 1	0x0014	varies
RMT_CH2CONF0_REG	Configuration register 0 for channel 2	0x0018	R/W
RMT_CH2CONF1_REG	Configuration register 1 for channel 2	0x001C	varies
RMT_CH3CONF0_REG	Configuration register 0 for channel 3	0x0020	R/W
RMT_CH3CONF1_REG	Configuration register 1 for channel 3	0x0024	varies
RMT_SYS_CONF_REG	Configuration register for RMT APB	0x0068	R/W
RMT_REF_CNT_RST_REG	Reset register for RMT clock divider	0x0070	WT
Status Registers			
RMT_CH0STATUS_REG	Channel 0 status register	0x0028	RO
RMT_CH1STATUS_REG	Channel 1 status register	0x002C	RO
RMT_CH2STATUS_REG	Channel 2 status register	0x0030	RO
RMT_CH3STATUS_REG	Channel 3 status register	0x0034	RO
Interrupt Registers			
RMT_INT_RAW_REG	Raw interrupt status	0x0038	R/WTC/SS
RMT_INT_ST_REG	Masked interrupt status	0x003C	RO
RMT_INT_ENA_REG	Interrupt enable bits	0x0040	R/W
RMT_INT_CLR_REG	Interrupt clear bits	0x0044	WT
Carrier Wave Duty Cycle Registers			
RMT_CH0CARRIER_DUTY_REG	Duty cycle configuration register for channel 0	0x0048	R/W
RMT_CH1CARRIER_DUTY_REG	Duty cycle configuration register for channel 1	0x004C	R/W
RMT_CH2_RX_CARRIER_RM_REG	Carrier remove register for channel 2	0x0050	R/W
RMT_CH3_RX_CARRIER_RM_REG	Carrier remove register for channel 3	0x0054	R/W
TX Event Configuration Registers			
RMT_CH0_TX_LIM_REG	Configuration register for channel 0 TX event	0x0058	varies
RMT_CH1_TX_LIM_REG	Configuration register for channel 1 TX event	0x005C	varies
RMT_TX_SIM_REG	RMT TX synchronous register	0x006C	R/W
RX Event Configuration Registers			

Name	Description	Address	Access
RMT_CH2_RX_LIM_REG	Configuration register for channel 2 RX event	0x0060	R/W
RMT_CH3_RX_LIM_REG	Configuration register for channel 3 RX event	0x0064	R/W
Version Register			
RMT_DATE_REG	Version control register	0x00CC	R/W

36.5 Registers

The addresses in this section are relative to Remote Control Peripheral base address provided in Table 5-2 in Chapter 5 *System and Memory*.

Register 36.1. RMT_CH n DATA_REG (n : 0-3) (0x0000+0x4* n)

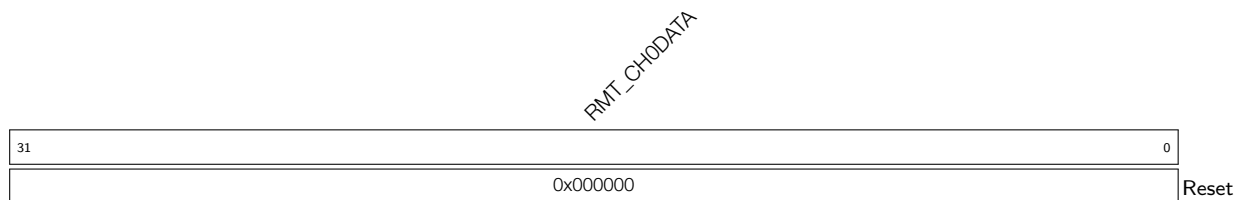

RMT_CH n DATA Read and write data for channel n via APB FIFO. (HRO)

Register 36.2. RMT_CH n CONF0_REG (n : 0-1) (0x0010+0x4* n)

(reserved)								RMT_CONF_UPDATE_CH n			(reserved)			RMT_CARRIER_OUT_LV_CH n			RMT_CARRIER_EN_CH n			(reserved)			RMT_MEM_SIZE_CH n			RMT_DIV_CNT_CH n			RMT_TX_STOP_CH n			RMT_IDLE_OUT_EN_CH n			RMT_IDLE_OUT_LV_CH n			RMT_MEM_TX_WRAP_EN_CH n			RMT_TX_CONTI_MODE_CH n			RMT_APB_MEM_RD_RST_CH n			RMT_MEM_RD_RST_CH n			RMT_TX_START_CH n		
31					25	24	23	22	21	20	19	18	16		15							8	7	6	5	4	3	2	1	0	Reset																					
0	0	0	0	0	0	0	0	1	1	1	0	0x1		0x2								0	0	0	0	0	0	0	0	0																						

RMT_TX_START_CH n Configures whether to enable sending data in channel n .

- 0: No effect
 - 1: Enable
- (WT)

RMT_MEM_RD_RST_CH n Configures whether to reset RAM read address accessed by the transmitter for channel n .

- 0: No effect
 - 1: Reset
- (WT)

RMT_APB_MEM_RST_CH n Configures whether to reset RAM W/R address accessed by APB FIFO for channel n .

- 0: No effect
 - 1: Reset
- (WT)

RMT_TX_CONTI_MODE_CH n Configures whether to enable continuous TX mode for channel n .

- 0: No Effect
- 1: Enable

In this mode, the transmitter starts transmission from the first data. If an end-marker is encountered, the transmitter starts transmitting data from the first data again; if no end-marker is encountered, the transmitter starts transmitting the first data again when the last data is transmitted.

(R/W)

RMT_MEM_TX_WRAP_EN_CH n Configures whether to enable wrap TX mode for channel n .

- 0: No effect
- 1: Enable

In this mode, if the TX data size is larger than the channel's RAM block size, the transmitter continues transmitting the first data to the last data in loops.

(R/W)

RMT_IDLE_OUT_LV_CH n Configures the level of output signal for channel n when the transmitter is in idle state. (R/W)

RMT_IDLE_OUT_EN_CH n Configures whether to enable the output for channel n in idle state.

- 0: No effect
 - 1: Enable
- (R/W)

Continued on the next page...

Register 36.2. RMT_CH n CONF0_REG (n : 0-1) (0x0010+0x4* n)

Continued from the previous page...

RMT_TX_STOP_CH n Configures whether to stop the transmitter of channel n sending data out.

0: No effect

1: Stop

(R/W/SC)

RMT_DIV_CNT_CH n Configures the divider for clock of channel n .

Measurement unit: rmt_sclk

(R/W)

RMT_MEM_SIZE_CH n Configures the maximum number of memory blocks allocated to channel n .

(R/W)

RMT_CARRIER_EFF_EN_CH n Configures whether to add carrier modulation on the output signal only at data-sending state for channel n .

0: Add carrier modulation on the output signal at data-sending state and idle state for channel n

1: Add carrier modulation on the output signal only at data-sending state for channel n

Only valid when RMT_CARRIER_EN_CH n is 1.

(R/W)

RMT_CARRIER_EN_CH n Configures whether to enable the carrier modulation on output signal for channel n .

0: Disable

1: Enable

(R/W)

RMT_CARRIER_OUT_LV_CH n Configures the position of carrier wave for channel n .

0: Add carrier wave on low level

1: Add carrier wave on high level

(R/W)

RMT_CONF_UPDATE_CH n Synchronization bit for channel n . (WT)

Register 36.3. RMT_CH m CONF0_REG (m : 2-3) (0x0008+0x8* m)

(reserved)		RMT_CARRIER_OUT_LV_CH m		RMT_CARRIER_EN_CH m		(reserved)		RMT_MEM_SIZE_CH m		RMT_IDLE_THRES_CH m		RMT_DIV_CNT_CH m	
31	30	29	28	27	26	25	23	22	8	7	0		
0	0	1	1	0	0	0x1	0x7fff				0x2		Reset

RMT_DIV_CNT_CH m Configures the clock divider of channel m .

Measurement unit: rmt_sclk

(R/W)

RMT_IDLE_THRES_CH m Configures RX threshold.

When no edge is detected on the input signal for continuous clock cycles longer than this field value, the receiver stops receiving data.

Measurement unit: clk_div

(R/W)

RMT_MEM_SIZE_CH m Configures the maximum number of memory blocks allocated to channel m .

(R/W)

RMT_CARRIER_EN_CH m Configures whether to enable carrier modulation on output signal for channel m .

0: Disable

1: Enable

(R/W)

RMT_CARRIER_OUT_LV_CH m Configures the position of carrier wave for channel m .

0: Add carrier wave on low level

1: Add carrier wave on high level

(R/W)

Register 36.4. RMT_CH m CONF1_REG (m : 2-3) (0x000C+0x8* m)

(reserved)																RMT_CONF_UPDATE_CH m (reserved)			RMT_MEM_RX_WRAP_EN_CH m			RMT_RX_FILTER_THRES_CH m			RMT_RX_FILTER_EN_CH m RMT_MEM_OWNER_RST_CH m RMT_APB_MEM_RST_CH m RMT_MEM_WR_RST_CH m RMT_RX_EN_CH m				
31															16	15	14	13	12	0xf			5	4	3	2	1	0	
0	0	0	0	0	0	0	0	0	0	0	0	0	0	0	0	0	0	0	0	0	1	0	0	0	0				

Reset

RMT_RX_EN_CH m Configures whether to enable the receiver to start receiving data in channel m .

0: Disable

1: Enable

(R/W)

RMT_MEM_WR_RST_CH m Configures whether to reset RAM write address accessed by the receiver for channel m .

0: No effect

1: Reset

(WT)

RMT_APB_MEM_RST_CH m Configures whether to reset RAM W/R address accessed by APB FIFO for channel m .

0: No effect

1: Reset

(WT)

RMT_MEM_OWNER_CH m Configures the ownership of channel m 's RAM block.

0: APB bus is using the RAM

1: Receiver is using the RAM

(R/W/SC)

RMT_RX_FILTER_EN_CH m Configures whether to enable the receiver's filter for channel m .

0: Disable

1: Enable

(R/W)

RMT_RX_FILTER_THRES_CH m Configures whether the receiver, when receiving data, ignores the input pulse when its width is shorter than this register value in units of rmt_sclk cycles.

0: No effect

1: Reset

(R/W)

RMT_MEM_RX_WRAP_EN_CH m Configures whether to enable wrap RX mode for channel m .

0: Disable

1: Enable

In this mode, if the RX data size is larger than channel m 's RAM block size, the receiver stores the RX data from the first address to the last address in loops.

(R/W)

RMT_CONF_UPDATE_CH m Synchronization bit for channel m . (WT)

Register 36.5. RMT_SYS_CONF_REG (0x0068)

RMT_CLK_EN		(reserved)		(reserved)		(reserved)		(reserved)		(reserved)		RMT_MEM_FORCE_PU		RMT_MEM_FORCE_PD		RMT_MEM_CLK_FORCE_ON		RMT_APB_FIFO_MASK		
31	30	27	26	25	24	23	18	17	12	11	4	3	2	1	0	Reset				
0	0	0	0	0	1	0x1	0x0		0x0		0x1		0	0	0	0				

RMT_APB_FIFO_MASK Configures the memory access mode.

0: Access memory by FIFO

1: Access memory directly

(R/W)

RMT_MEM_CLK_FORCE_ON Configures whether to enable the clock for RMT memory.

0: Disable

1: Enable

(R/W)

RMT_MEM_FORCE_PD Configures whether to power down RMT memory.

0: No effect

1: Power down

(R/W)

RMT_MEM_FORCE_PU Configures whether to disable the power-down function of RMT memory in Light-sleep.

0: Power down RMT memory when RMT is in Light-sleep mode

1: Disable the power-down function of RMT memory in Light-sleep

(R/W)

RMT_CLK_EN Configures whether to enable signal of RMT register clock gate.

0: Power down the drive clock of registers

1: Power up the drive clock of registers

(R/W)

Register 36.7. RMT_CH n STATUS_REG (n : 0-1) (0x0028+0x4* n)

RMT_APB_MEM_RADDR_CH n				RMT_APB_MEM_WR_ERR_CH n				RMT_APB_MEM_WADDR_CH n				RMT_STATE_CH n				RMT_MEM_RADDR_EX_CH n			
31	24	23	22	21	20	12	11	9	8					0					
0x0				0	0	0	0				0	0				Reset			

RMT_MEM_RADDR_EX_CH n Represents the memory address offset when transmitter of channel n is using the RAM. (RO)

RMT_STATE_CH n Represents the FSM status of channel n . (RO)

RMT_APB_MEM_WADDR_CH n Represents the memory address offset when writes RAM over APB bus. (RO)

RMT_APB_MEM_RD_ERR_CH n Represents whether the offset address exceeds memory size when reading via APB bus.

0: Not exceed

1: Exceed

(RO)

RMT_MEM_EMPTY_CH n Represents whether the TX data size exceeds the memory size and the wrap TX mode is disabled.

0: Not exceed

1: Exceed

(RO)

RMT_APB_MEM_WR_ERR_CH n Represents whether the offset address exceeds memory size (overflows) when writes via APB bus.

0: Not exceed

1: Exceed

(RO)

RMT_APB_MEM_RADDR_CH n Represents the memory address offset when reading RAM over APB bus. (RO)

Register 36.8. RMT_CH m STATUS_REG (m : 2-3) (0x0028+0x4* m)

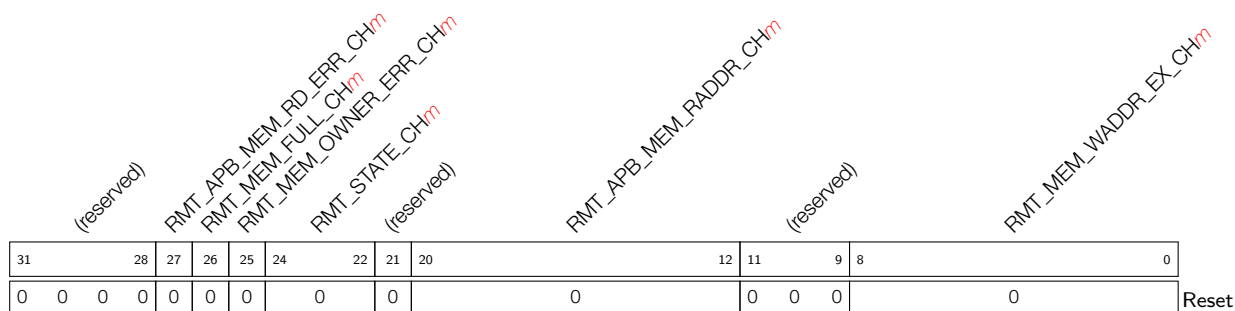

RMT_MEM_WADDR_EX_CH m Represents the memory address offset when receiver of channel m is using the RAM. (RO)

RMT_APB_MEM_RADDR_CH m Represents the memory address offset when reads RAM over APB bus. (RO)

RMT_STATE_CH m Represents the FSM status of channel m . (RO)

RMT_MEM_OWNER_ERR_CH m Represents whether the ownership of memory block is wrong.
 0: The ownership of memory block is correct
 1: The ownership of memory block is wrong
 (RO)

RMT_MEM_FULL_CH m Represents whether the receiver receives more data than the memory can fit.
 0: The receiver does not receive more data than the memory can fit
 1: The receiver receives more data than the memory can fit
 (RO)

RMT_APB_MEM_RD_ERR_CH m Represents whether the offset address exceeds memory size (overflows) when reads RAM via APB bus.
 0: Not exceed
 1: Exceed
 (RO)

Register 36.9. RMT_INT_RAW_REG (0x0038)

(reserved)														RMT_CH1_TX_LOOP_INT_RAW RMT_CH0_TX_LOOP_INT_RAW RMT_CH3_RX_THR_EVENT_INT_RAW RMT_CH2_RX_THR_EVENT_INT_RAW RMT_CH1_TX_THR_EVENT_INT_RAW RMT_CH0_TX_THR_EVENT_INT_RAW RMT_CH3_ERR_INT_RAW RMT_CH2_ERR_INT_RAW RMT_CH1_ERR_INT_RAW RMT_CH0_ERR_INT_RAW RMT_CH3_RX_END_INT_RAW RMT_CH2_RX_END_INT_RAW RMT_CH1_TX_END_INT_RAW RMT_CH0_TX_END_INT_RAW																	
31														14	13	12	11	10	9	8	7	6	5	4	3	2	1	0			
0														0																	Reset

RMT_CH n _TX_END_INT_RAW The raw interrupt status of RMT_CH n _TX_END_INT. Triggered when the transmission is done. (R/WTC/SS)

RMT_CH m _RX_END_INT_RAW The raw interrupt status of RMT_CH m _RX_END_INT. Triggered when the reception is done. (R/WTC/SS)

RMT_CH n/m _ERR_INT_RAW The raw interrupt status of RMT_CH n/m _ERR_INT. Triggered when error occurs. (R/WTC/SS)

RMT_CH n _TX_THR_EVENT_INT_RAW The raw interrupt status of RMT_CH n _TX_THR_EVENT_INT. Triggered when the transmitter sent more data than the configured value. (R/WTC/SS)

RMT_CH m _RX_THR_EVENT_INT_RAW The raw interrupt status of RMT_CH m _RX_THR_EVENT_INT. Triggered when the receiver receives more data than the configured value. (R/WTC/SS)

RMT_CH n _TX_LOOP_INT_RAW The raw interrupt status of RMT_CH n _TX_LOOP_INT. Triggered when the loop count reaches the configured threshold value. (R/WTC/SS)

Register 36.10. RMT_INT_ST_REG (0x003C)

(reserved)														RMT_CH1_TX_LOOP_INT_ST RMT_CH0_TX_LOOP_INT_ST RMT_CH3_RX_THR_EVENT_INT_ST RMT_CH2_RX_THR_EVENT_INT_ST RMT_CH1_TX_THR_EVENT_INT_ST RMT_CH0_TX_THR_EVENT_INT_ST RMT_CH3_ERR_INT_ST RMT_CH2_ERR_INT_ST RMT_CH1_ERR_INT_ST RMT_CH0_ERR_INT_ST RMT_CH3_RX_END_INT_ST RMT_CH2_RX_END_INT_ST RMT_CH1_TX_END_INT_ST RMT_CH0_TX_END_INT_ST																
31														14	13	12	11	10	9	8	7	6	5	4	3	2	1	0	Reset	
0 0 0 0 0 0 0 0 0 0 0 0 0 0 0 0														0	0	0	0	0	0	0	0	0	0	0	0	0	0	0	0	0

RMT_CH n _TX_END_INT_ST The masked interrupt status of RMT_CH n _TX_END_INT. (RO)

RMT_CH m _RX_END_INT_ST The masked interrupt status of RMT_CH m _RX_END_INT. (RO)

RMT_CH n/m _ERR_INT_ST The masked interrupt status of RMT_CH n/m _ERR_INT. (RO)

RMT_CH n _TX_THR_EVENT_INT_ST The masked interrupt status of RMT_CH n _TX_THR_EVENT_INT. (RO)

RMT_CH m _RX_THR_EVENT_INT_ST The masked interrupt status of RMT_CH m _RX_THR_EVENT_INT. (RO)

RMT_CH n _TX_LOOP_INT_ST The masked interrupt status of RMT_CH n _TX_LOOP_INT. (RO)

Register 36.11. RMT_INT_ENA_REG (0x0040)

(reserved)														RMT_CH1_TX_LOOP_INT_ENA RMT_CH0_TX_LOOP_INT_ENA RMT_CH3_RX_THR_EVENT_INT_ENA RMT_CH2_RX_THR_EVENT_INT_ENA RMT_CH1_TX_THR_EVENT_INT_ENA RMT_CH0_TX_THR_EVENT_INT_ENA RMT_CH3_ERR_INT_ENA RMT_CH2_ERR_INT_ENA RMT_CH1_ERR_INT_ENA RMT_CH0_ERR_INT_ENA RMT_CH3_RX_END_INT_ENA RMT_CH2_RX_END_INT_ENA RMT_CH1_TX_END_INT_ENA RMT_CH0_TX_END_INT_ENA																
31														14	13	12	11	10	9	8	7	6	5	4	3	2	1	0	Reset	
0 0 0 0 0 0 0 0 0 0 0 0 0 0 0 0														0	0	0	0	0	0	0	0	0	0	0	0	0	0	0	0	0

RMT_CH n _TX_END_INT_ENA Write 1 to enable RMT_CH n _TX_END_INT. (R/W)

RMT_CH m _RX_END_INT_ENA Write 1 to enable RMT_CH m _RX_END_INT. (R/W)

RMT_CH n/m _ERR_INT_ENA Write 1 to enable RMT_CH n/m _ERR_INT. (R/W)

RMT_CH n _TX_THR_EVENT_INT_ENA Write 1 to enable RMT_CH n _TX_THR_EVENT_INT. (R/W)

RMT_CH m _RX_THR_EVENT_INT_ENA Write 1 to enable RMT_CH m _RX_THR_EVENT_INT. (R/W)

RMT_CH n _TX_LOOP_INT_ENA Write 1 to enable RMT_CH n _TX_LOOP_INT. (R/W)

Register 36.12. RMT_INT_CLR_REG (0x0044)

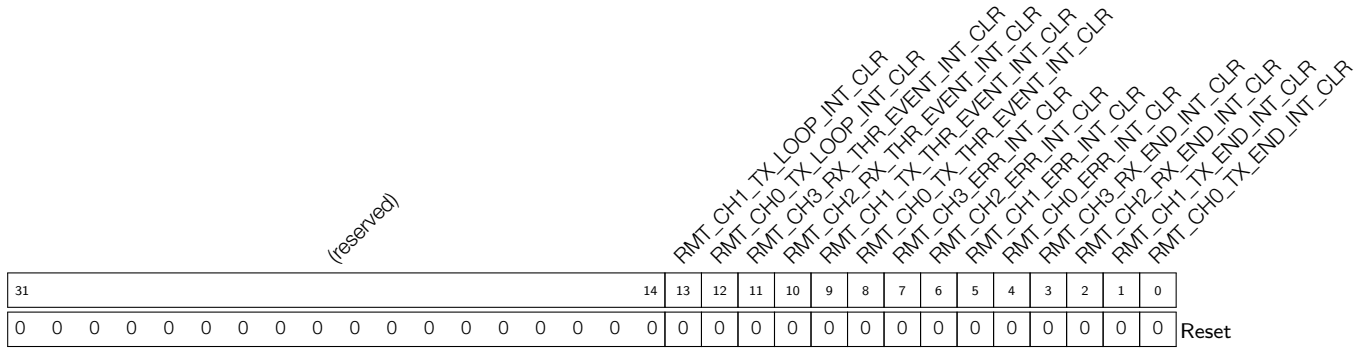

RMT_CH n _TX_END_INT_CLR Write 1 to clear RMT_CH n _TX_END_INT. (WT)

RMT_CH m _RX_END_INT_CLR Write 1 to clear RMT_CH m _RX_END_INT. (WT)

RMT_CH n/m _ERR_INT_CLR Write 1 to clear RMT_CH n/m _ERR_INT. (WT)

RMT_CH n _TX_THR_EVENT_INT_CLR Write 1 to clear RMT_CH n _TX_THR_EVENT_INT. (WT)

RMT_CH m _RX_THR_EVENT_INT_CLR Write 1 to clear RMT_CH m _RX_THR_EVENT_INT. (WT)

RMT_CH n _TX_LOOP_INT_CLR Write 1 to clear RMT_CH n _TX_LOOP_INT. (WT)

Register 36.13. RMT_CH n CARRIER_DUTY_REG (n : 0-1) (0x0048+0x4* n)

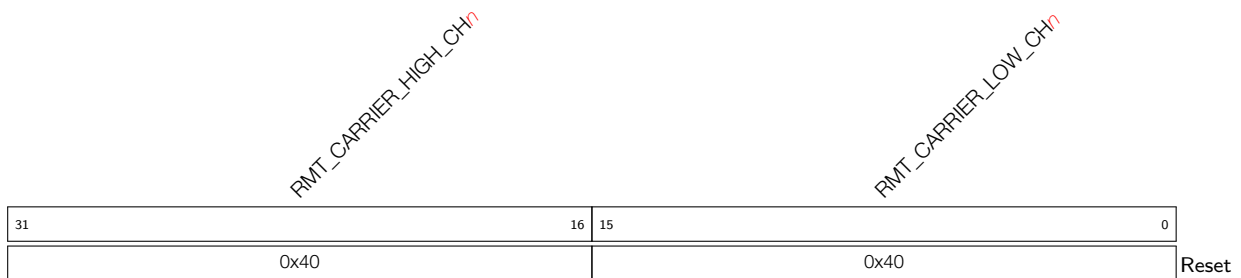

RMT_CARRIER_LOW_CH n Configures carrier wave's low level clock period for channel n .
 Measurement unit: rmt_sclk
 (R/W)

RMT_CARRIER_HIGH_CH n Configures carrier wave's high level clock period for channel n .
 Measurement unit: rmt_sclk
 (R/W)

Register 36.14. RMT_CH m _RX_CARRIER_RM_REG (m : 2-3) (0x0048+0x4* m)

RMT_CARRIER_LOW_THRES_CH m Configures the low level period in a carrier modulation mode for channel m .

The low level period in a carrier modulation mode is (RMT_CARRIER_LOW_THRES_CH m + 1) for channel m .

Measurement unit: clk_div

(R/W)

RMT_CARRIER_HIGH_THRES_CH m Configures the high level period in a carrier modulation mode for channel m .

The high level period in a carrier modulation mode is (REG_RMT_REG_CARRIER_HIGH_THRES_CH m + 1) for channel m .

Measurement unit: clk_div

(R/W)

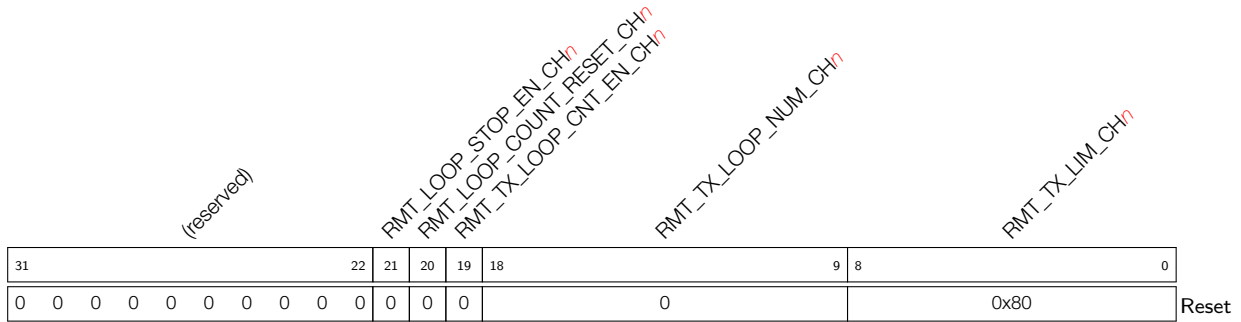
Register 36.15. RMT_CH n _TX_LIM_REG (n : 0-1) (0x0058+0x4* n)

RMT_TX_LIM_CH n Configures the maximum entries that channel n can send out. (R/W)

RMT_TX_LOOP_NUM_CH n Configures the maximum loop count when Continuous TX mode is valid.
(R/W)

RMT_TX_LOOP_CNT_EN_CH n Configures whether to enable loop count.
0: No effect
1: Enable
(R/W)

RMT_LOOP_COUNT_RESET_CH n Configures whether to reset the loop count when tx_conti_mode is valid.
0: No effect
1: Reset
(WT)

RMT_LOOP_STOP_EN_CH n Configures whether to enable the loop send stop function after the loop counter counts to loop number for channel n .
0: No effect
1: Enable
(R/W)

Register 36.16. RMT_TX_SIM_REG (0x006C)

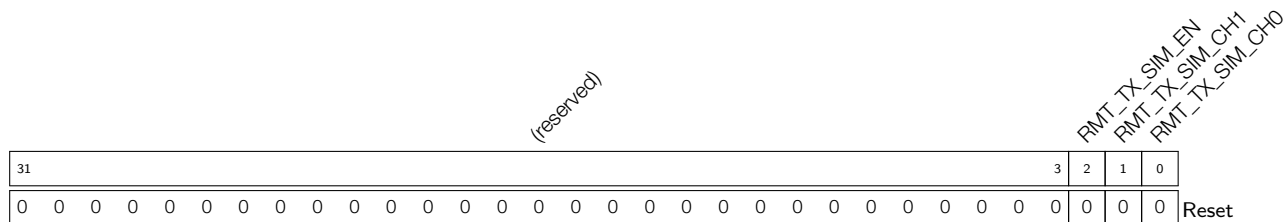

RMT_TX_SIM_CH n Configures whether to enable channel n to start sending data synchronously with other enabled channels.

0: No effect

1: Enable

(R/W)

RMT_TX_SIM_EN Configures whether to enable multiple of channels to start sending data synchronously.

0: No effect

1: Enable

(R/W)

Register 36.17. RMT_CH m _RX_LIM_REG (m : 2-3) (0x0058+0x4* m)

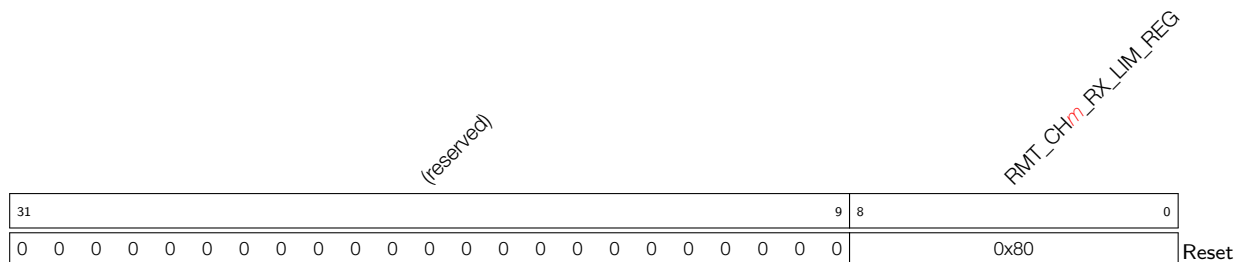

RMT_CH m _RX_LIM_REG Configures the maximum entries that channel m can receive. (R/W)

Register 36.18. RMT_DATE_REG (0x00CC)

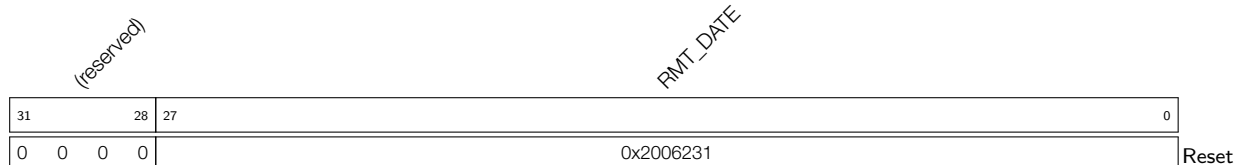

RMT_DATE Version control register. (R/W)

37 Parallel IO Controller (PARL_IO)

37.1 Introduction

ESP32-C6 contains a Parallel IO controller (PARLIO) capable of transferring data between external devices and internal memory on a parallel bus through GDMA. It is composed of a TX unit and an RX unit, which are fixed as a transmitter and a receiver respectively. With the two units combined, PARLIO achieves full-duplex communication.

Due to its flexibility, PARLIO can function as a general interface to connect various peripherals. For example, with SPI as the master device and PARLIO as the slave device, a peer-to-peer transfer can be achieved. For detailed application examples, refer to Section 37.7.

37.2 Glossary

This section covers terminology used to describe the functionality of PARLIO.

RX unit	Module in PARLIO responsible for receiving data from external parallel bus and storing them into internal memory.
TX unit	Module in PARLIO responsible for transmitting data from internal memory to external parallel bus.
RXD	Parallel data received from the IO interface of the RX unit.
TXD	Parallel data sent to the IO interface of the TX unit.
Frame	Transferred data unit from the moment the START signal is set to the moment the End of Frame (EOF) signal is received.
Free-running clock	Clock that toggles continuously. Otherwise, the clock only toggles during the period when valid data is received and remains constant for the rest of the time.
GDMA SUC EOF	Signal that indicates GDMA successful end of frame. When GDMA receives this signal, a GDMA interrupt will be triggered, indicating that the current frame is correct and the receive is finished.
GDMA ERR EOF	Signal that indicates GDMA error end of frame. When GDMA receives this signal, a GDMA interrupt will be triggered, indicating that the current frame has error and the receive is finished.
CDC	Clock domain crossing.

37.3 Features

The PARLIO module has the following main features:

- Variety of clock sources:
 - Including external IO clock PAD_CLK and internal system clocks XTAL_CLK, PLL_F240M_CLK, and RC_FAST_CLK
 - Maximum clock frequency of 40 MHz
 - Integer clock frequency division
- 1/2/4/8/16-bit configurable data bus width

- Half-duplex communication with 16-bit data bus width and full-duplex communication with 8-bit data bus width
- Bit reordering in 1/2/4-bit data bus width mode
- RX unit for receiving IO parallel data, which supports:
 - RX unit input clock inverse
 - Variety of receive modes
 - Configurable GDMA SUC EOF generation
 - Configurable IO pin of external enable signal
- TX unit for sending IO parallel data, which supports:
 - TX unit output clock inverse
 - Valid signal output
 - Configurable bus idle value

37.4 Architectural Overview

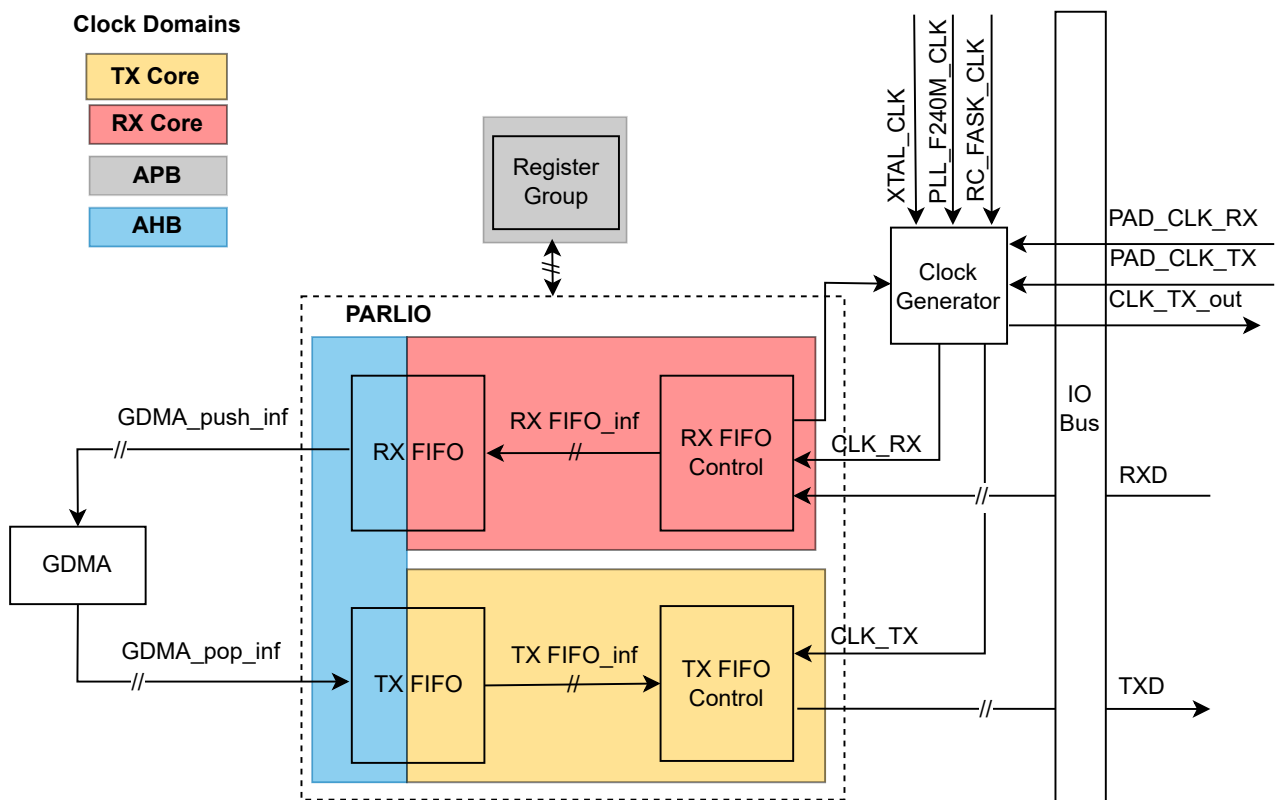

Figure 37-1. PARLIO Architecture

Figure 37-1 shows the architecture of PARLIO. In addition to the RX unit and the TX unit, a group of status configuration registers is also included.

The RX unit converts RXD into an asynchronous FIFO interface, which synchronizes RXD to the AHB clock domain. RXD is then converted to a standard GDMA interface and sent to the internal memory.

The TX unit fetches data from internal memory through GDMA and converts the GDMA interface into an asynchronous FIFO interface. The asynchronous FIFO synchronizes the data to the TX Core clock domain and converts the data to TXD for parallel IO bus output.

37.5 Functional Description

37.5.1 Clock Generator

There are four input clock domains in PARLIO, namely, RX Core, TX Core, AHB, and APB.

The status configuration register group works in the APB clock domain.

The GDMA interface logic works in the AHB clock domain.

RX Core and TX Core clock domains each have four clock sources for selection, i.e., the internal system clock sources XTAL_CLK, RC_FAST_CLK, PLL_F240M_CLK, and the external clock source (PAD_CLK_TX/RX), as shown in Figure 37-2. Clock sources can be selected by configuring `PCR_PARL_CLK_RX_SEL` and `PCR_PARL_CLK_TX_SEL`. The clock can be divided by configuring `PCR_PARL_CLK_RX_DIV_NUM` and `PCR_PARL_CLK_TX_DIV_NUM`. The clock division factor can be configured up to $(2^{16} - 1)$.

The input clock of the RX unit can be inverted. The operating clock of the TX unit can also be inverted before being output to IO.

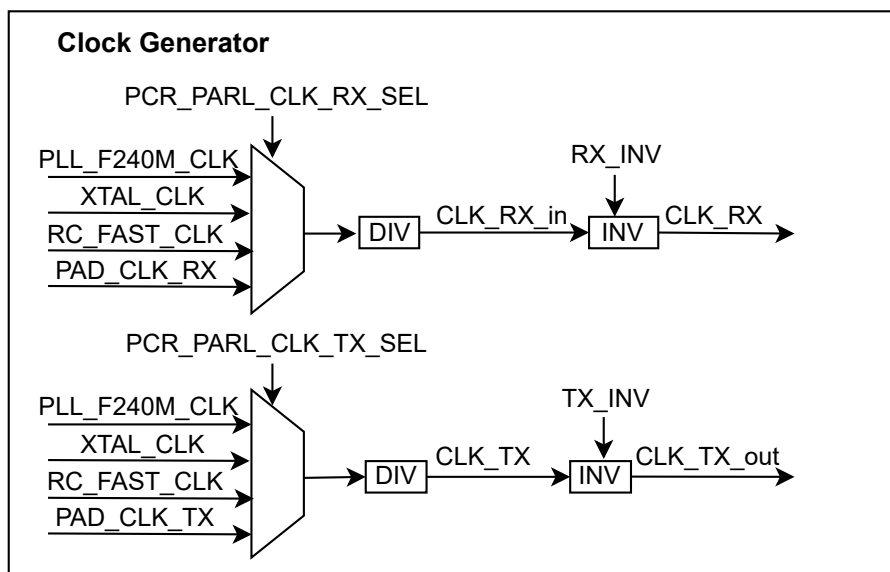

Figure 37-2. PARLIO Clock Generation

37.5.2 Clock & Reset Restriction

Due to the versatility of PARLIO, the PAD clocks of PARLIO may come from different masters (external devices or internal clock sources). These clocks might be either free-running clock or not. If the clock is not free-running, some internal control signals of PARLIO cannot process CDC, so there are certain restrictions during the operation.

1. During the reset of the asynchronous FIFO, it takes two clock cycles to synchronize within AHB clock domain and Core clock domain. Therefore, if the reset of AHB clock domain is performed with a clock that

is not free-running, the reset synchronization must be performed two clock cycles in advance. The specific operation is as follows:

- **Scenario 1:** The current frame transfer is based on free-running clock, but the next frame transfer is not based on free-running clock.
Operation: Users can reset the next frame transfer before switching to the clock that is not free-running. After the reset is completed, users can switch the clock.
- **Scenario 2:** The current frame transfer is not based on free-running clock, but the next frame transfer is based on free-running clock.
Operation: The next frame can be reset freely. Users only need to ensure that there is an interval of two clock cycles between the reset and the start of the transfer.
- **Scenario 3:** Both the current and next frame transfers are not based on free-running clock.
Operation: If the next frame transfer needs to be reset, users need to first switch to the internal free-running clock, and then switch to the actual clock after the reset is completed.

2. Due to the restrictions caused by a clock that is not free-running, [PARL_IO_RX_START](#) and [PARL_IO_TX_START](#) cannot perform CDC processing. Therefore, it is necessary to wait until [PARL_IO_RX_START](#) and [PARL_IO_TX_START](#) are stable before starting the data transfer, otherwise the transfer might enter a metastable state.

Here are the specific operation steps in the RX unit:

- Clear [PCR_PARL_CLK_RX_EN](#) to turn off RX Core clock domain;
- Write 1 to [PARL_IO_RX_START](#);
- Set [PCR_PARL_CLK_RX_EN](#) to turn on RX Core clock domain;
- Operate the external device to start sending data;
- Clear [PCR_PARL_CLK_RX_EN](#) to turn off RX Core clock domain;
- Write 0 to [PARL_IO_RX_START](#).

Here are the specific operation steps in the TX unit:

- Clear [PCR_PARL_CLK_TX_EN](#) to turn off TX Core clock domain;
- Write 1 to [PARL_IO_TX_START](#);
- Set [PCR_PARL_CLK_TX_EN](#) to turn on TX Core clock domain;
- Operate the external device to start receiving data;
- Clear [PCR_PARL_CLK_TX_EN](#) to turn off TX Core clock domain;
- Write 0 to [PARL_IO_TX_START](#).

3. Reset should follow the requirements below:

- The clock reset during the chip start-up should follow the sequence below:
 - First reset APB clock domain;
 - Then reset AHB clock domain;
 - Finally reset Core clock domain.
- Inter-frame transfer requires Core clock domain reset and async FIFO reset.

37.5.3 Master-Slave Mode

The TX unit can function as both master and slave while the RX unit can only function as slave.

When the TX unit serves as master, it is necessary to set the internal free-running clock as the clock source. The TX unit drives TXD on the rising edge of the clock.

When the TX unit functions as a slave device, there are three scenarios:

- **Scenario 1:** The clock sent by the master device is a free-running clock.
Requirement: There is no requirement for the acquisition edge of the master clock.
- **Scenario 2:** The clock sent by the master device is not a free-running clock, and the clock waveform is as shown in Figure 37-3.
Requirement: The master clock should capture TXD at the falling edge.

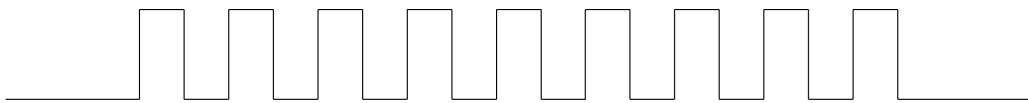

Figure 37-3. Master Clock Positive Waveform

- **Scenario 3:** The clock sent by the master device is not a free-running clock, and the clock waveform is as shown in Figure 37-4.
Requirement: The master device should invert the original clock and convert it to the waveform as Figure 37-3 shows before output.

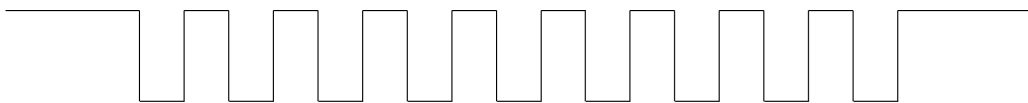

Figure 37-4. Master Clock Negative Waveform

For the RX unit which can only function as slave, the following three scenarios can occur:

- **Scenario 1:** The clock sent by the master device is a free-running clock.
Requirement: There is no requirement for the acquisition edge of the master clock, and the valid data is subject to the external enable signal.
- **Scenario 2:** The clock sent by the master device is not a free-running clock, and the clock waveform is as shown in Figure 37-3.
Requirement: It is required for the master device to drive the data at the rising edge and the RX unit to capture the data at the falling edge (i.e., to inverse the master clock).
- **Scenario 3:** The clock sent by the master device is not a free-running clock, and the clock waveform is as shown in Figure 37-4.
Requirement: It is required for the master device to drive the data at the falling edge and the RX unit to capture the data at the rising edge (i.e., to use the original master clock).

37.5.4 Receive Modes of the RX Unit

PARLIO supports 15 receive modes, which can be divided into three major categories according to the enable signal:

- Level Enable mode: data received is enabled by the external signal level;
- Pulse Enable mode: data received is enabled by the external signal pulse;
- Software Enable mode: the enable signal of data received can be configured by users directly.

37.5.4.1 Level Enable Mode

Level Enable mode can be divided into two sub-modes depending on the active level of the external enable signal, as shown in Figure 37-5.

In both cases, an active level on the external enable signal must be aligned with valid data. Since the external level enable signal occupies one IO pin, there are at most 15 IO pins left usable for RXD.

Mode	Sub-mode	Description
<i>LEVEL_ENABLE</i>	sub-mode 1	<i>signal level high</i>
		
	sub-mode 2	<i>signal level low</i>
		

Figure 37-5. Sub-Modes of Level Enable Mode for RX Unit

37.5.4.2 Pulse Enable Mode

Pulse Enable mode can be divided into 12 sub-modes depending on the pulse active level and its alignment with valid data. For detailed classification, see Figure 37-6.

Sub-modes 1 ~ 8 all contain start pulse and end pulse. The difference lies in whether start pulse and end pulse are aligned with valid data.

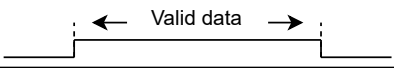
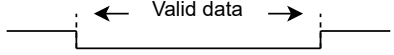
Sub-modes 9 ~ 12 only contain start pulse and the end of valid data is signaled by configuring [PARL_IO_RX_DATA_BYTELEN](#).

Since the external pulse enable signal occupies one IO pin, there are at most 15 IO pins left usable for RXD. However, in sub-modes 4, 8, 10, and 12, as the data is considered valid before the pulse's first edge and after the pulse's last edge, the enable signal IO pin can serve as a data IO pin at the same time. Therefore, there are 16 IO pins usable for RXD in these two sub-modes.

Mode	Sub-mode	Description
PULSE_ENABLE	sub-mode 1	<i>pulse start(data bit include) & pulse end(data bit include)</i>
		
	sub-mode 2	<i>pulse start(data bit include) & pulse end(data bit exclude)</i>
		
	sub-mode 3	<i>pulse start(data bit exclude) & pulse end(data bit include)</i>
		
	sub-mode 4	<i>pulse start(data bit exclude) & pulse end(data bit exclude)</i>
		
	sub-mode 5	<i>pulse start(data bit include) & pulse end(data bit include)</i>
		
	sub-mode 6	<i>pulse start(data bit include) & pulse end(data bit exclude)</i>
		
sub-mode 7	<i>pulse start(data bit exclude) & pulse end(data bit include)</i>	
		
sub-mode 8	<i>pulse start(data bit exclude) & pulse end(data bit exclude)</i>	
		
sub-mode 9	<i>pulse start(data bit include) & length end</i>	
		
sub-mode 10	<i>pulse start(data bit exclude) & length end</i>	
		
sub-mode 11	<i>pulse start(data bit include) & length end</i>	
		
sub-mode 12	<i>pulse start(data bit exclude) & length end</i>	
		

Figure 37-6. Sub-Modes of Pulse Enable Mode for RX Unit

37.5.4.3 Software Enable Mode

The enable signal in Software Enable mode is determined by the internal configuration register. If users switch to this mode, the receive will only be activated when both `PARL_IO_RX_SW_EN` and `PARL_IO_RX_START` are set to 1.

Since the enable signal does not occupy IO pins on the interface, there are at most 16 IO pins usable by the RXD. Due to the differences of clock domains, the enable signal cannot be aligned with valid data. Thus, the validity of data needs to be identified by the valid clock edge. In this case, the RX Core clock needs to be aligned with valid data.

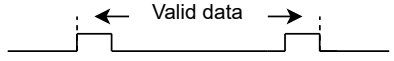
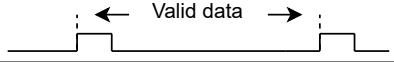
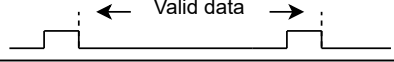
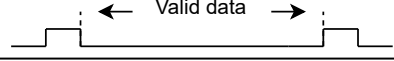
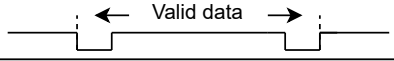
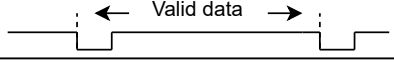
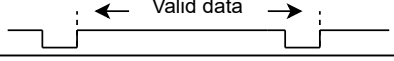
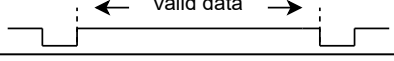
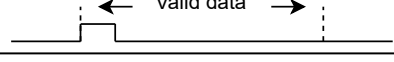
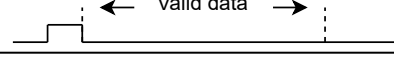
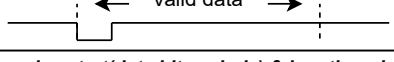
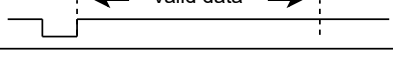
Mode	Sub-mode	Description
SW_ENABLE	/	/
		

Figure 37-7. Sub-Mode of Software Enable Mode for RX Unit

37.5.5 RX Unit GDMA SUC EOF Generation

The RX unit generates a GDMA SUC EOF signal to indicate the end of current frame transfer and send it to the GDMA interface. GDMA SUC EOF can be generated by an external enable signal or by the internally configured byte length.

- When GDMA SUC EOF is generated by the internally configured byte length, there is no restriction on the receive mode selection. However, [PARL_IO_RX_DATA_BYTELEN](#) must be configured. If the configured value of [PARL_IO_RX_DATA_BYTELEN](#) is less than the actual received data, the GDMA SUC EOF will be triggered in advance. In this case, the RX unit stops reading data from the FIFO, but the FIFO continues to receive external data until an [RX_FIFO_WFULL_INTR](#) interrupt is triggered.
- When GDMA SUC EOF is generated by the external enable signal, only sub-modes 1, 3, 5, and 7 of Pulse Enable mode can be selected. In this mode, the transfer is not affected by the value of [PARL_IO_RX_DATA_BYTELEN](#), and the transferred data of the frame is not limited.

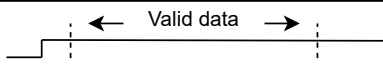
37.5.6 RX Unit Timeout

The RX unit supports the receive timeout. When the timeout is triggered, a GDMA ERR EOF signal will be generated and sent to the GDMA interface to indicate the end of the receiving. Configure [PARL_IO_RX_TIMEOUT_THRESHOLD](#) to set the timeout threshold.

The timeout function is enabled by default and can be disabled by users. The upper threshold of the configurable timeout is $(2^{16} - 1)$ cycles of AHB clock domain, and the lower threshold depends on the relative frequency relationship between AHB clock domain and RX Core clock domain. It is recommended to set a relatively large value for [PARL_IO_RX_TIMEOUT_THRESHOLD](#) to avoid undesired GDMA ERR EOF signals.

37.5.7 Valid Signal Output of TX Unit

The TX unit can generate a valid signal aligned with TXD. Configure [PARL_IO_TX_HW_VALID_EN](#) to choose whether to output it to TXD. The polarity of the valid signal is fixed to active high.

The valid output function is disabled by default. When enabled, the output valid signal occupies the MSB of the TXD, which means that no matter what the original value is, the 15th bit of TXD remains high and is output as the valid signal. However, the valid signal pin does not affect the bus width configuration. For example, if user configures data bus width as 1 bit, the valid output function can still be enabled with a fixed pin as TXD[15] while the data pin is TXD[0].

37.5.8 Bus Idle Value of TX Unit

The TX unit is regarded as in idle state when it is not transmitting data. It supports a configurable bus idle value.

The bus idle value is 0x0 by default, and its maximum configurable value is 0xFFFF. Note that the configured idle value should not conflict with other enabled functions. For example, when the MSB of TXD is used as the valid signal, users should avoid configuring the MSB of the idle value as 1.

37.5.9 Data Transfer in a Single Frame

The RX unit and the TX unit are transferred in the unit of bytes, i.e., a single frame transfers 1 byte of data at least.

When the RX unit generates GDMA EOF signals through byte length, the maximum length of the single-frame transmission is $(2^{16} - 1)$ bytes. When the RX unit generates GDMA EOF signals through the enable signal from an external device, there is no limit to the amount of bytes of the single-frame transmission.

The TX unit only generates GDMA EOF signals through byte length, so the maximum length of a single frame transmission is $(2^{16} - 1)$ bytes.

When the configured data bus width is 16 bit, the byte length must be configured as a multiple of 2 bytes.

Normally, PARLIO can perform full-duplex transfer. But when in 16-bit bus width mode, PARLIO can only perform half-duplex transfer due to the limitation of the IO numbers.

37.5.10 Bit Reordering in One Byte

The sequence of data within one byte can be reversed. Taking the RX unit as an example, when the configured bus width is 2 bit, the data needs to be packed into one byte before being written into the RX FIFO.

Presume that the original bit sequence is:

$$\{ \{ b_0, b_1 \}, \{ b_2, b_3 \}, \{ b_4, b_5 \}, \{ b_6, b_7 \} \}$$

If the bit reordering function is enabled, the sequence will be reordered to:

$$\{ \{ b_6, b_7 \}, \{ b_4, b_5 \}, \{ b_2, b_3 \}, \{ b_0, b_1 \} \}$$

37.6 Programming Procedures

37.6.1 Data Receiving Operation Process

This section introduces the programming procedure for receiving data in the RX unit. Perform the following procedure to receive parallel data from IO pins connected to external devices to be stored in the internal memory. For detailed description of the clock and reset operation restrictions in the RX unit, refer to Section 37.5.2.

1. Reset the RX unit. For specific reset scenarios and sequences, refer to Section 37.5.2.
2. Set `PARL_IO_RX_FIFO_WFULL_INT_CLR` and `PARL_IO_RX_FIFO_WFULL_INT_ENA`.
3. Select the RXD IO pins. If a PAD clock is used, the clock IO pin also needs to be configured.
4. Select the clock source and divide the clock by configuring PCR registers.
5. Turn off the clock of RX Core clock domain.
6. Select the receive mode and enable functions required as described in Sections 37.3 and 37.5.
7. Configure GDMA inlink list.
8. Set `PARL_IO_RX_REG_UPDATE` to synchronize the register signals.

9. Set [PARL_IO_RX_START](#).
10. Turn on the clock of RX Core clock domain.
11. Operate the external device to start sending data.
12. Poll the GDMA SUC EOF interrupt.
13. Clear the GDMA SUC EOF interrupt.
14. Turn off the clock of RX Core clock domain.
15. Clear [PARL_IO_RX_START](#).

37.6.2 Data Transmitting Operation Process

This section introduces the programming procedure for transmitting data in the TX unit. Perform the following procedure to transmit parallel data from internal memory to the IO pins connected to external devices. For detailed description of the clock and reset operation restrictions in the TX unit, refer to Section [37.5.2](#).

1. Reset the TX unit. For specific reset scenarios and sequences, refer to Section [37.5.2](#).
2. Set [PARL_IO_TX_FIFO_EMPTY_INT_CLR](#), [PARL_IO_TX_EOF_INT_CLR](#), [PARL_IO_TX_FIFO_EMPTY_INT_ENA](#), and [PARL_IO_TX_EOF_INT_ENA](#) consecutively.
3. Select the TXD IO pins. If a PAD clock is used, the clock IO PAD also needs to be configured.
4. Select the clock source and divide the clock by configuring PCR registers.
5. Turn off the clock of TX Core clock domain.
6. Select the functions required as described in Section [37.5](#).
7. Configure GDMA outlink list.
8. Poll the [PARL_IO_TX_READY](#).
9. Set [PARL_IO_TX_START](#).
10. Turn on the clock of TX Core clock domain.
11. Operate the external device to start receiving data.
12. Poll the [PARL_IO_TX_EOF_INT_ST](#).
13. Set [PARL_IO_TX_EOF_INT_CLR](#).
14. Turn off the clock of TX Core clock domain.
15. Clear [PARL_IO_TX_START](#).

37.7 Application Examples

This section introduces some PARLIO application examples and their detailed operation process. All peripherals used in the examples are from ESP series chips and can work with PARLIO to form a complete data path.

Note:

The data paths constructed in the examples may not be the optimal. For example, users can use the SPI peripherals on two identical ESP chips to complete the peer-to-peer transfer in real case instead of using PARLIO to work with SPI.

However, these examples demonstrate the flexibility of the PARLIO interface to a certain extent.

37.7.1 Co-working with SPI

In this example, external SPI sends data as a master device and PARLIO RX unit receives data as a slave device, and at the same time, PARLIO TX sends data as a master device and SPI receives data as a slave device, thus achieving a peer-to-peer serial data transfer.

- Follow the operation process below to achieve SPI transmit and PARLIO receive:
 - Configure SPI clock.
 - Configure SPI as the master device.
 - Configure signal pins. Connect FSPICLK to PAD_CLK_RX, FSPICS0 to RXD[16], and FSPID to RXD[0].
 - Write the data sent into the SPI buffer and configure the bit length of the data sent.
 - Set [SPI_UPDATE](#) to update the configured register value.
 - Reset PARLIO RX unit.
 - Configure PARLIO RX unit clock.
 - Turn off the PARLIO RX Core clock domain.
 - Configure PARLIO receive mode as sub-mode 1 of Level Enable mode. Configure RX unit data bus width as 1 bit. Configure [PARL_IO_RX_DATA_BYTELEN](#) according to the sending length of SPI. Set [PARL_IO_RX_REG_UPDATE](#).
 - Configure PARLIO GDMA inlink list.
 - Set [PARL_IO_RX_START](#).
 - Turn on the PARLIO RX Core clock domain.
 - Set [SPI_USR](#) to start transmitting data of SPI.
 - Poll GDMA SUC EOF interrupt.
 - Clear [PARL_IO_RX_START](#).
- Follow the operation process below to achieve PARLIO transmit and SPI receive:
 - Configure SPI clock.
 - Configure SPI as the slave device.
 - Configure signal pins. Connect FSPICLK to PAD_CLK_TX, FSPICS0 to TXD[16], and FSPID to TXD[0].
 - Set [SPI_RD_BIT_ORDER](#) to invert the bit order.
 - Set [SPI_UPDATE](#) to update the configured register value.
 - Reset PARLIO TX unit.
 - Set [PARL_IO_TX_EOF_INT_CLR](#) and [PARL_IO_TX_EOF_INT_ENA](#).
 - Configure PARLIO TX unit clock.
 - Turn off the clock of TX Core clock domain.

- Configure data bus width as 1 bit. Write 1 to [PARL_IO_TX_HW_VALID_EN](#). Configure [PARL_IO_TX_BYTELEN](#).
- Configure GDMA outlink list.
- Poll [PARL_IO_TX_READY](#).
- Write 1 to [PARL_IO_TX_START](#).
- Turn on the clock of TX Core clock domain.
- Start data transfer.
- Poll [PARL_IO_TX_EOF_INT_ST](#).
- Set [PARL_IO_TX_EOF_INT_CLR](#).
- Turn off the clock of TX Core clock domain.
- Clear [PARL_IO_TX_START](#).

37.7.2 Co-working with I2S

In this example, external I2S sends data as a master device and PARLIO RX unit receives data as a slave device. PARLIO supports the transmission of the I2S TDM MSB alignment standard and the TDM PCM standard. When the I2S transfer protocol is the TDM MSB alignment standard, it is required to configure the receive mode of PARLIO as Level Enable mode. When the I2S transfer protocol is the TDM PCM standard, it is required to configure the receive mode of PARLIO as the sub-mode 10 of Pulse Enable mode.

This section takes the TDM PCM alignment standard as an example. The specific operation process is as follows:

1. Configure I2S clock.
2. Configure signal pins. Connect I2SO_BCK_out to PAD_CLK_RX, I2SO_WS_out to RXD[16], and I2SO_Data_out to RXD[0].
3. Configure I2S as the master device.
4. Configure the I2S TX data mode and channel mode required. Set [I2S_TX_UPDATE](#).
5. Reset I2S TX unit and TX FIFO.
6. Enable [I2S_TX_DONE_INT](#).
7. Configure I2S GDMA outlink list.
8. Set [I2S_TX_STOP_EN](#).
9. Reset PARLIO RX unit.
10. Configure PARLIO RX unit clock.
11. Turn off PARLIO RX Core clock domain.
12. Configure PARLIO receive mode as sub-mode 10 of Pulse Enable mode. Configure the RX unit data bus width as 1 bit. Configure [PARL_IO_RX_DATA_BYTELEN](#) according to the length of the data sent by I2S. Set [PARL_IO_RX_REG_UPDATE](#).
13. Configure PARLIO GDMA inlink list.

14. Set [PARL_IO_RX_START](#).
15. Turn on PARLIO RX Core clock domain.
16. Set [I2S_TX_START](#) to start transmitting data.
17. Poll [I2S_TX_DONE_INT](#).
18. Poll GDMA SUC EOF interrupt.
19. Clear [I2S_TX_START](#).
20. Clear [PARL_IO_RX_START](#).

37.7.3 Co-working with Camera

Note:

ESP32-C6 does not support camera interface. For detailed descriptions about Camera control register fields mentioned below, please refer to the documentation of corresponding ESP series chips.

In this example, PARLIO TX unit sends data as a master device and external camera controller receives data as a slave device. 8-bit parallel data is transferred between devices. The specific operation process is as follows:

1. Configure Camera system clock. The internal clock frequency should be larger than twice the frequency of the PARLIO output clock.
2. Configure signal pins. Connect CLK_TX_out to CAM_PCLK, TXD[7:0] to CAM_Data_in[7:0], TXD[8] to CAM_H_ENABLE, TXD[9] to CAM_V_SYNC, and TXD[10] to CAM_H_SYNC.
3. Set or clear LCD_CAM_CAM_VH_DE_MODE_EN according to the control signal HSYNC.
4. Set the RX channel mode and RX data mode required, then set the bit LCD_CAM_CAM_UPDATE.
5. Reset Camera Unit and Async FIFO.
6. Enable LCD_CAM_CAM_HS_INT and LCD_CAM_CAM_VSYNC_INT.
7. Configure GDMA inlink list, and set the length of RX data in LCD_CAM_CAM_REC_DATA_BYTELEN.
8. Set LCD_CAM_CAM_START.
9. Reset PARLIO TX unit.
10. Set [PARL_IO_TX_FIFO_EMPTY_INT_CLR](#), [PARL_IO_TX_EOF_INT_CLR](#), [PARL_IO_TX_FIFO_EMPTY_INT_ENA](#), and [PARL_IO_TX_EOF_INT_ENA](#) consecutively.
11. Configure PARLIO TX unit clock.
12. Turn off the clock of TX Core clock domain.
13. Configure data bus width as 16 bit. Configure [PARL_IO_TX_BYTELEN](#).
14. Configure GDMA outlink list. Note that the data sent in the linked list should conform to the Camera format. The lower eight bits are valid parallel data. The 9th, 10th, and 11th bits are respectively CAM_H_ENABLE, CAM_V_SYNC, and CAM_H_SYNC. The MSB is the constant 1. The remaining bits are arbitrary values.
15. Poll [PARL_IO_TX_READY](#).
16. Write 1 to [PARL_IO_TX_START](#).

17. Turn on the clock of TX Core clock domain.
18. Start data transfer.
19. Poll [PARL_IO_TX_EOF_INT_ST](#).
20. Set [PARL_IO_TX_EOF_INT_CLR](#).
21. Turn off the clock of TX Core clock domain.
22. Clear [PARL_IO_TX_START](#).

37.8 Interrupts

- [TX_FIFO_EMPTY_INT](#): Triggered when TX FIFO is empty. This interrupt indicates that there might be error in the data sent by TX.
- [RX_FIFO_WFULL_INT](#): Triggered when RX FIFO is full. This interrupt indicates that there might be error in the data received by RX.
- [TX_EOF_INT](#): Triggered when TX finishes sending a complete frame of data.

37.9 Register Summary

The addresses in this section are relative to Parallel IO Controller base address provided in Table 5-2 in Chapter 5 *System and Memory*.

The abbreviations given in Column **Access** are explained in Section *Access Types for Registers*.

Name	Description	Address	Access
PARLIO RX Configuration Registers			
PARL_IO_RX_CFG0_REG	PARLIO RX module configuration register 0	0x0000	R/W
PARL_IO_RX_CFG1_REG	PARLIO RX module configuration register 1	0x0004	varies
PARLIO TX Configuration Registers			
PARL_IO_TX_CFG0_REG	PARLIO TX module configuration register 0	0x0008	R/W
PARL_IO_TX_CFG1_REG	PARLIO TX module configuration register 1	0x000C	R/W
PARLIO TX Status Register			
PARL_IO_ST_REG	PARLIO module status register 0	0x0010	RO
PARLIO Interrupt Configuration and Status Registers			
PARL_IO_INT_ENA_REG	PARLIO interrupt enable register	0x0014	R/W
PARL_IO_INT_RAW_REG	PARLIO interrupt raw register	0x0018	R/SS/WTC
PARL_IO_INT_ST_REG	PARLIO interrupt status register	0x001C	RO
PARL_IO_INT_CLR_REG	PARLIO interrupt clear register	0x0020	WT
PARLIO Clock Gating Configuration Register			
PARL_IO_CLK_REG	PARLIO clock configuration register	0x0120	R/W
PARLIO Version Register			
PARL_IO_VERSION_REG	Version control register	0x03FC	R/W

37.10 Registers

The addresses in this section are relative to Parallel IO Controller base address provided in Table 5-2 in Chapter 5 *System and Memory*.

Register 37.1. PARL_IO_RX_CFG0_REG (0x0000)

PARL_IO_RX_FIFO_SRST		PARL_IO_RX_BUS_WID_SEL		PARL_IO_RX_BIT_PACK_ORDER		PARL_IO_RX_CLK_EDGE_SEL		PARL_IO_RX_SMP_MODE_SEL		PARL_IO_RX_LEVEL_SUBMODE_SEL		PARL_IO_RX_PULSE_SUBMODE_SEL		PARL_IO_RX_SW_EN		PARL_IO_RX_DATA_BYTELEN		PARL_IO_RX_START		PARL_IO_RX_EOF_GEN_SEL		
31	30	28	27	26	25	24	23	22	19	18	17			2	1	0						
0	0	0	0	0x0	0	0	0	0	0	0	0	0x00		0	0	0					Reset	

PARL_IO_RX_EOF_GEN_SEL Configures the generating mechanism of GDMA SUC EOF.

0: Generate GDMA SUC EOF by the configured data byte length

1: Generate GDMA SUC EOF by the external enable signal

(R/W)

PARL_IO_RX_START Configures whether to start RX global data sampling.

0: No effect

1: Start

(R/W)

PARL_IO_RX_DATA_BYTELEN Configures data byte length received by RX. (R/W)

PARL_IO_RX_SW_EN Configures whether to enable software data sampling.

0: Disable

1: Enable

(R/W)

PARL_IO_RX_PULSE_SUBMODE_SEL Configures Pulse Enable sub-mode.

0: Positive pulse start (data bit included) & Positive pulse end (data bit included)

1: Positive pulse start (data bit included) & Positive pulse end (data bit excluded)

2: Positive pulse start (data bit excluded) & Positive pulse end (data bit included)

3: Positive pulse start (data bit excluded) & Positive pulse end (data bit excluded)

4: Positive pulse start (data bit included) & Length end

5: Positive pulse start (data bit excluded) & Length end

6: Negative pulse start (data bit included) & Negative pulse end (data bit included)

7: Negative pulse start (data bit included) & Negative pulse end (data bit excluded)

8: Negative pulse start (data bit excluded) & Negative pulse end (data bit included)

9: Negative pulse start (data bit excluded) & Negative pulse end (data bit excluded)

10: Negative pulse start (data bit included) & Length end

11: Negative pulse start (data bit excluded) & Length end

(R/W)

Continued on the next page...

Register 37.1. PARL_IO_RX_CFG0_REG (0x0000)

Continued from the previous page...

PARL_IO_RX_LEVEL_SUBMODE_SEL Configures whether to sample data at high or low level of the external enable signal.

0: At high level

1: At low level

(R/W)

PARL_IO_RX_SMP_MODE_SEL Configures RX data sampling mode.

0: External Level Enable mode

1: External Pulse Enable mode

2: Internal Software Enable mode

(R/W)

PARL_IO_RX_CLK_EDGE_SEL Configures whether to invert the RX input clock.

0: Not invert

1: Invert

(R/W)

PARL_IO_RX_BIT_PACK_ORDER Configures the packing order to pack bits into 1 byte when data bus width is 4/2/1 bit.

0: Pack from MSB

1: Pack from LSB

(R/W)

PARL_IO_RX_BUS_WID_SEL Configures RX data bus width.

0: 16 bit

1: 8 bit

2: 4 bit

3: 2 bit

4: 1 bit

(R/W)

PARL_IO_RX_FIFO_SRST Configures whether to enable soft reset of async FIFO in the RX unit.

0: Disable

1: Enable

(R/W)

Register 37.2. PARL_IO_RX_CFG1_REG (0x0004)

<i>PARL_IO_RX_TIMEOUT_THRESHOLD</i>																<i>PARL_IO_RX_EXT_EN_SEL</i>								<i>(reserved)</i>				<i>PARL_IO_RX_TIMEOUT_EN</i>				<i>PARL_IO_RX_REG_UPDATE</i>				<i>(reserved)</i>			
31																16	15					12	11					4	3	2	1	0							
0xff																0xf								0 0 0 0 0 0 0 0				1 0 0 0				Reset							

PARL_IO_RX_REG_UPDATE Configures whether to update RX register configuration signals.

- 0: No effect
 - 1: Update
- (WT)

PARL_IO_RX_TIMEOUT_EN Configures whether to enable timeout counter to generate GDMA ERR EOF.

- 0: Disable
 - 1: Enable
- (R/W)

PARL_IO_RX_EXT_EN_SEL Configures RX external enable signal from one of the 16 IO pins. (R/W)

PARL_IO_RX_TIMEOUT_THRESHOLD Configures RX threshold of timeout counter.

- Measurement unit: AHB clock cycle
- (R/W)

Register 37.3. PARL_IO_TX_CFG0_REG (0x0008)

(reserved)		PARL_IO_TX_FIFO_SRST		PARL_IO_TX_BUS_WID_SEL		PARL_IO_TX_BIT_UNPACK_ORDER		PARL_IO_TX_SMP_EDGE_SEL		(reserved)		PARL_IO_TX_HW_VALID_EN		PARL_IO_TX_START		(reserved)		PARL_IO_TX_BYTELEN		(reserved)		
31	30	29	27	26	25	24	21	20	19	18	17									2	1	0
0	0	0	0	0	0	0	0	0	0	0	0										0	0

Reset

PARL_IO_TX_BYTELEN Configures the byte length of the data sent by TX. (R/W)

PARL_IO_TX_START Configures whether to start TX global data output.

0: No effect

1: Start

(R/W)

PARL_IO_TX_HW_VALID_EN Configures whether to enable TX hardware data valid signal.

0: Disable

1: Enable

(R/W)

PARL_IO_TX_SMP_EDGE_SEL Configures whether to invert the TX output clock

0: Not invert

1: Invert (R/W)

PARL_IO_TX_BIT_UNPACK_ORDER Configures the unpacking order to unpack bits from 1 byte when data bus width is 4/2/1 bit.

0: Unpack from MSB

1: Unpack from LSB

(R/W)

PARL_IO_TX_BUS_WID_SEL Configures TX data bus width.

0: 16 bit

1: 8 bit

2: 4 bit

3: 2 bit

4: 1 bit

(R/W)

Continued on the next page...

Register 37.3. PARL_IO_TX_CFG0_REG (0x0008)

Continued from the previous page...

PARL_IO_TX_FIFO_SRST Configures whether to enable soft reset of async FIFO in the TX unit.

0: Disable

1: Enable

(R/W)

Register 37.4. PARL_IO_TX_CFG1_REG (0x000C)

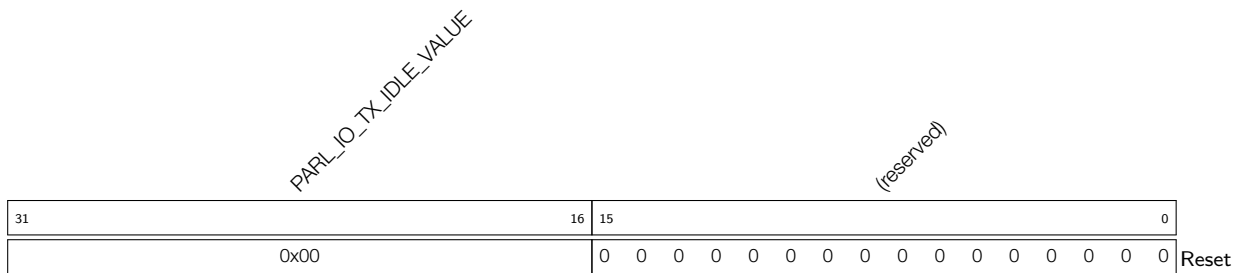

PARL_IO_TX_IDLE_VALUE Configures the data value on TX bus when in idle state. (R/W)

Register 37.5. PARL_IO_ST_REG (0x0010)

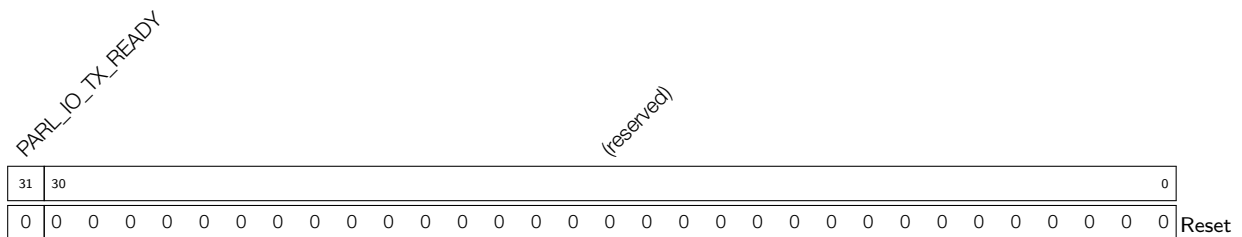

PARL_IO_TX_READY Represents the status of TX.

0: Not ready

1: Ready

(RO)

Register 37.8. PARL_IO_INT_ST_REG (0x001C)

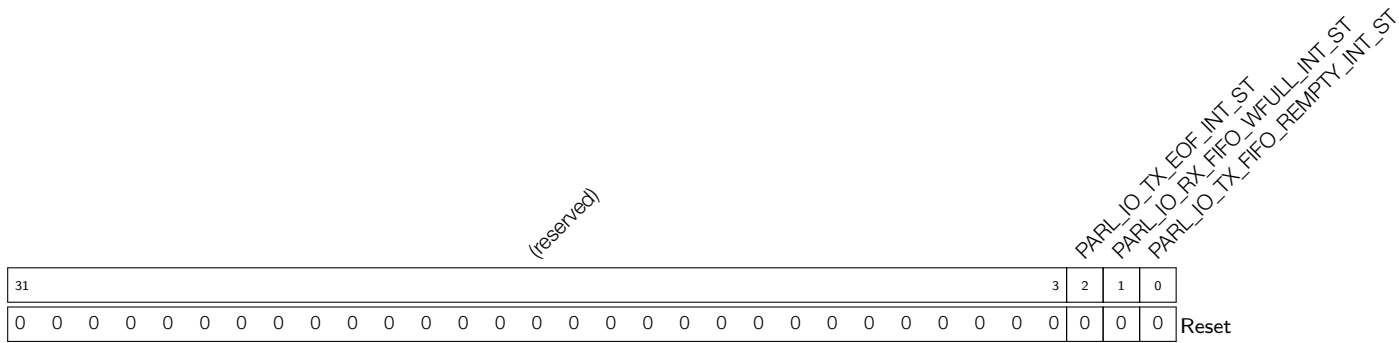

PARL_IO_TX_FIFO_EMPTY_INT_ST The masked interrupt status of [TX_FIFO_EMPTY_INT](#). (RO)

PARL_IO_RX_FIFO_WFULL_INT_ST The masked interrupt status of [RX_FIFO_WFULL_INT](#). (RO)

PARL_IO_TX_EOF_INT_ST The masked interrupt status of [TX_EOF_INT](#). (RO)

Register 37.9. PARL_IO_INT_CLR_REG (0x0020)

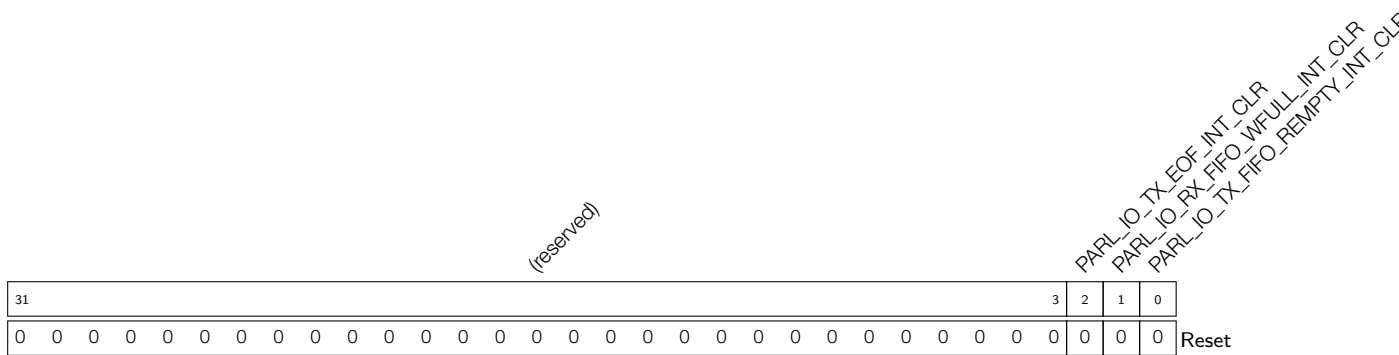

PARL_IO_TX_FIFO_EMPTY_INT_CLR Write 1 to clear [TX_FIFO_EMPTY_INT](#). (WT)

PARL_IO_RX_FIFO_WFULL_INT_CLR Write 1 to clear [RX_FIFO_WFULL_INT](#). (WT)

PARL_IO_TX_EOF_INT_CLR Write 1 to clear [TX_EOF_INT](#). (WT)

Register 37.10. PARL_IO_CLK_REG (0x0120)

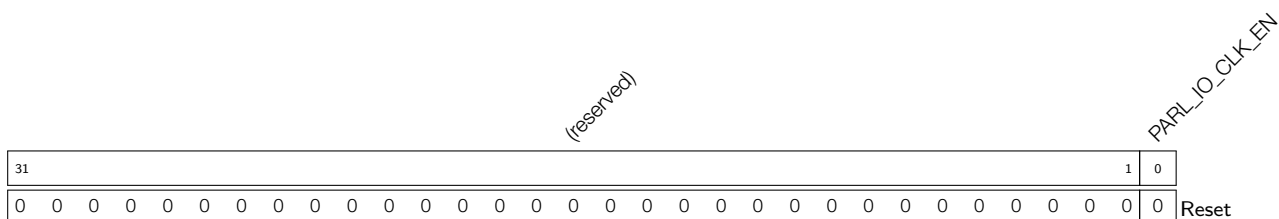

PARL_IO_CLK_EN Configures whether to force clock on for this register file.

0: No effect

1: Force clock on

(R/W)

Register 37.11. PARL_IO_VERSION_REG (0x03FC)

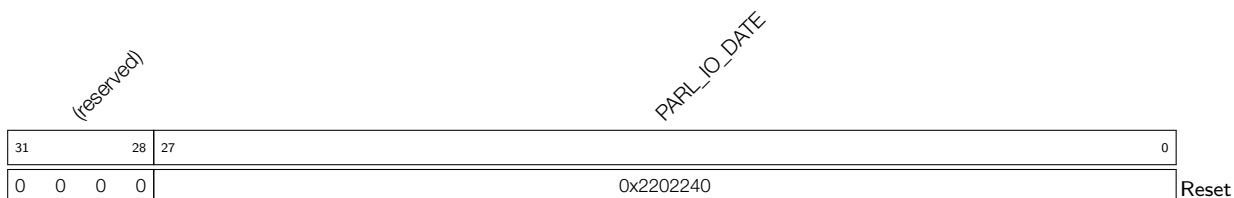

PARL_IO_DATE Version control register. (R/W)

38 On-Chip Sensor and Analog Signal Processing

38.1 Overview

ESP32-C6 provides the following on-chip sensor and analog signal processing peripherals:

- One 12-bit Successive Approximation ADC (SAR ADC) for measuring analog signals from seven channels;
- One temperature sensor for measuring the internal temperature of the ESP32-C6 chip.

38.2 SAR ADC

38.2.1 Overview

ESP32-C6 integrates a 12-bit SAR ADC which is able to measure analog signals from up to seven pins. It is also possible to measure internal signals, such as VDD33. The SAR ADC is managed by the DIG ADC controller, which drives the [Digital_reader](#) to sample channel voltages by SAR ADC. It supports high-performance multi-channel scanning and DMA continuous conversion.

38.2.2 Features

- 12-bit sampling resolution
- Analog voltage sampling from up to seven pins
- DIG ADC controller:
 - Separate control modules for one-time sampling and multi-channel scanning
 - Configurable channel scanning sequence in multi-channel scanning mode
 - Two filters with configurable filter coefficient
 - Threshold monitoring, which helps to trigger an interrupt when the sampled value is greater than the pre-set high threshold or less than the pre-set low threshold
 - DMA

38.2.3 Functional Description

The major components of SAR ADC and their interconnections are shown in [Figure 38-1](#).

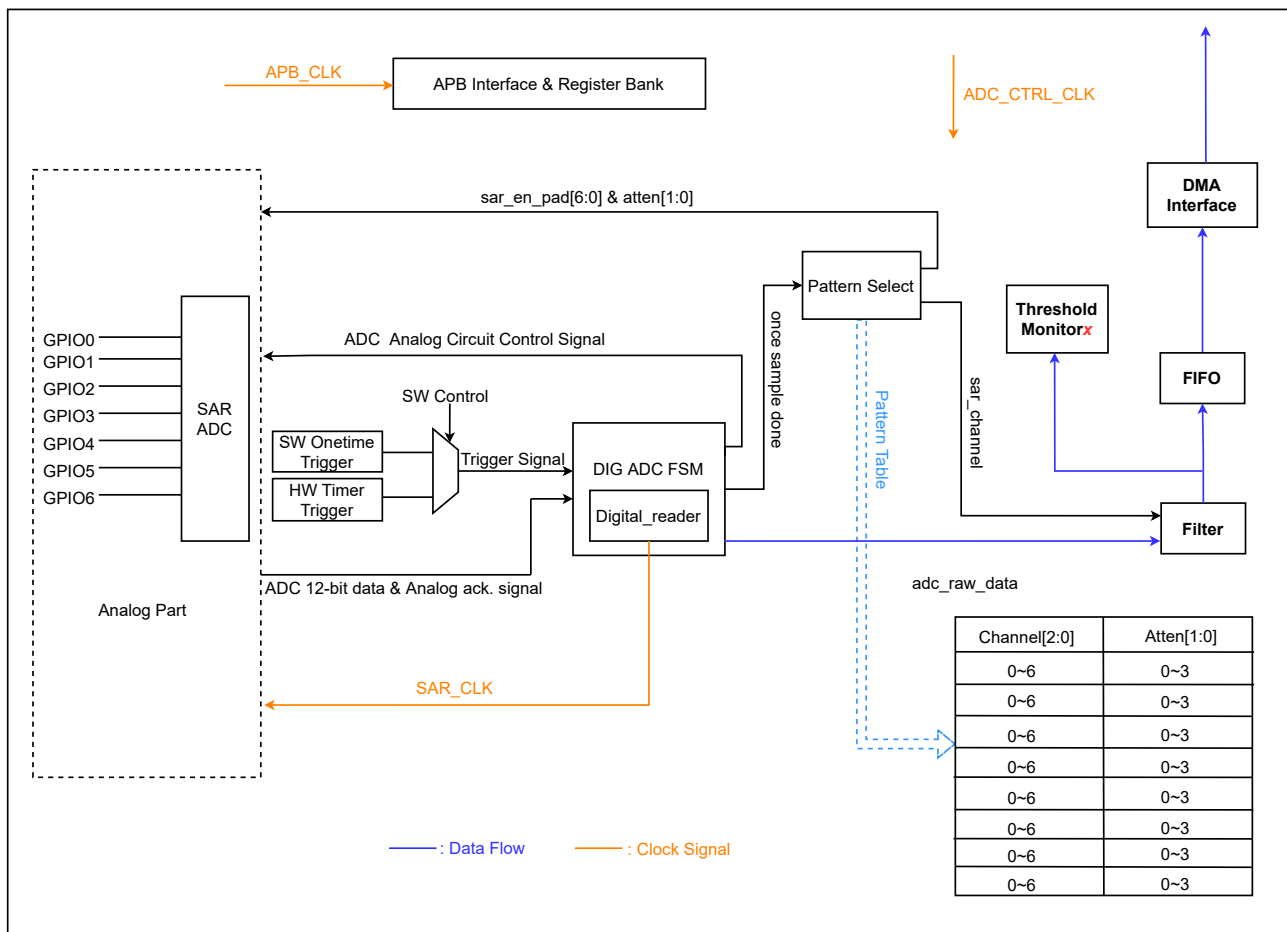

Figure 38-1. SAR ADCs Function Overview

As shown in Figure 38-1, the SAR ADC module provides the following functions and consists of the following components:

- Measures voltages from up to seven channels.
- Clock management: selects clock sources and their dividers:
 - Clock sources: can be XTAL_CLK, RC_FAST_CLK, or PLL_F80M_CLK;
 - Divided Clocks:
 - * SAR_CLK: operating clock for SAR ADC and Digital_reader (the control signal generator for analog circuit). Note that the divider (sar_div) of SAR_ADC must be no less than 15;
 - * ADC_CTRL_CLK: operating clock for DIG ADC FSM and other logic circuits except for APB interface and Digital_reader.
- Digital_reader (driven by DIG ADC FSM): reads data from SAR ADC.
- DIG ADC FSM: generates the signals required throughout the ADC sampling process.
- Threshold monitor_x: threshold monitor 1 and threshold monitor 2. The monitor_x will trigger an interrupt when the sampled value is greater than the pre-set high threshold or less than the pre-set low threshold.

The following sections describe the individual components in details.

38.2.3.1 Input Signals

In order to sample an analog signal, the SAR ADC must first select the analog pin to measure via an internal multiplexer. A summary of all the analog signals that may be sent to the SAR ADC module for processing by ADC are presented in Table 38-1.

Table 38-1. SAR ADC Input Signals

Signal	Channel	ADC Selection
X32K_P (GPIO0)	0	SAR ADC
X32K_N (GPIO1)	1	
GPIO2	2	
GPIO3	3	
MTMS (GPIO4)	4	
MTDI (GPIO5)	5	
MTCK (GPIO6)	6	

38.2.3.2 ADC Conversion and Attenuation

When the SAR ADC converts an analog voltage, the resolution (12-bit) of the conversion spans voltage range from 0 mV to V_{ref} . V_{ref} is the SAR ADC's internal reference voltage. The output value of the conversion (data) is mapped to analog voltage V_{data} using the following formula:

$$V_{data} = \frac{V_{ref}}{4095} \times data$$

In order to convert voltages larger than V_{ref} , input signals can be attenuated before being input into the SAR ADC. The attenuation can be configured to 0 dB, 2.5 dB, 6 dB, and 12 dB.

38.2.3.3 DIG ADC Controller

The clock of the DIG ADC controller is quite fast, thus the sample rate is high. This controller supports:

- up to 12-bit sampling resolution
- software-triggered one-time sampling
- timer-triggered multi-channel scanning

The configuration of a one-time sampling triggered by the software is as follows:

- Set `APB_SARADC_ONETIME_SAMPLE` to select SAR ADC to perform a one-time sampling.
- Configure `APB_SARADC_ONETIME_CHANNEL` to select a channel to sample.
- Configure `APB_SARADC_ONETIME_ATTEN` to set attenuation.
- Configure `APB_SARADC_ONETIME_START` to start the one-time sampling.
- Upon completion of sampling, the `APB_SARADC_ADC_DONE_INT_RAW` interrupt is generated. Once this interrupt is detected, software can initiate reading of the sampled values from `APB_SARADC_ADC_DATA`.

If the timer-triggered multi-channel scanning is selected, follow the configuration below. Note that in this mode, the scan sequence is performed according to the configuration entered in the pattern table.

- Configure `APB_SARADC_TIMER_TARGET` to set the trigger target for DIG ADC timer. When the timer counting reaches two times of the pre-configured cycle number, a sampling operation is triggered.
- Configure `APB_SARADC_TIMER_EN` to enable the timer.
- When the timer times out, it drives FSM to start sampling according to the pattern table.
- Sampled data is automatically stored in memory via DMA. An interrupt is triggered once the scan is completed.

Note:

One-time sampling and multi-channel scanning can not be configured to perform at the same time.

38.2.3.4 DMA Support

DIG ADC controller supports direct memory access via the peripheral DMA, which is triggered by DIG ADC timer. Users can switch the DMA data path to DIG ADC by configuring `APB_SARADC_APB_ADC_TRANS` via software. For specific DMA configuration, please refer to Chapter 4 *GDMA Controller (GDMA)*.

38.2.3.5 DIG ADC FSM

Overview

Figure 38-2 shows the diagram of DIG ADC FSM.

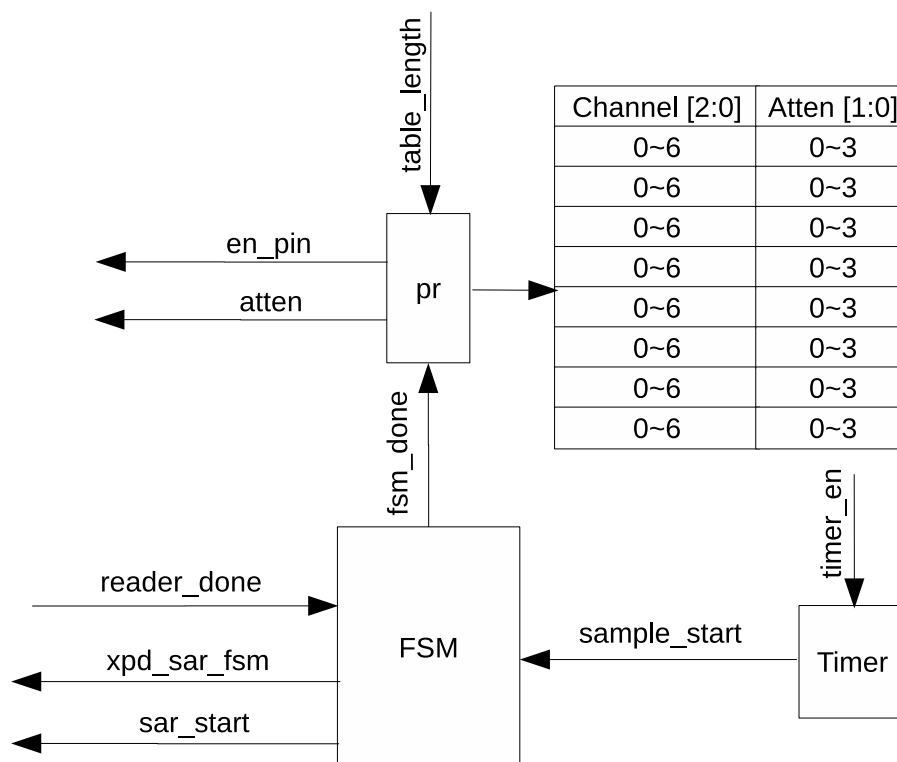

Figure 38-2. Diagram of DIG ADC FSM

Wherein:

- Timer: a dedicated timer for DIG ADC controller to generate a sample_start signal.
- pr: the pointer to pattern table entries. FSM sends out corresponding signals based on the configuration of the pattern table entry that the pointer points to.

Execution of the sampling process is as follows:

- Configure `APB_SARADC_TIMER_EN` to enable the DIG ADC timer. The timeout event of this timer triggers an sample_start signal. This signal drives the FSM module to start sampling.
- When the FSM module receives the sample_start signal, it starts the following operations:
 - Power up SAR ADC.
 - Configure the ADC channel and attenuation based on the pattern table entry that the current pr points to.
 - Output the corresponding en_pad and atten signals to the analog side according to the configuration information.
 - Initiate the sar_start signal and start sampling.
- When the FSM module receives the reader_done signal from ADC Reader (Digital_reader), it starts the following operations:
 - Stop sampling.
 - Transfer the data to the filter, and then threshold monitor transfers the data to memory via DMA (see Figure 38-1).
 - Update the pattern table pointer pr and wait for the next sampling. Note that if the pointer pr is smaller than `APB_SARADC_SAR_PATT_LEN` (table_length), then $pr = pr + 1$. Otherwise, pr is cleared.

Pattern Table

There is one pattern table in the controller, consisting of the `APB_SARADC_SAR_PATT_TAB1_REG` and `APB_SARADC_SAR_PATT_TAB2_REG` registers. See Figure 38-3 and Figure 38-4:

(reserved)								cmd0				cmd1				cmd2				cmd3						
31						24	23					18	17					12	11			6	5			0
0	0	0	0	0	0	0	0	0	0	0	0	0	0	0	0	0	0	0	0	0	0	0	0	0	0	0
								0x0000				0x0000				0x0000				0x0000						

`cmd x` represents pattern table entries. `x` here is the index numbered from 0 ~ 3.

Figure 38-3. APB_SARADC_SAR_PATT_TAB1_REG and Pattern Table Entry 0 - Entry 3

(reserved)								cmd4				cmd5				cmd6				cmd7						
31						24	23					18	17					12	11			6	5			0
0	0	0	0	0	0	0	0	0	0	0	0	0	0	0	0	0	0	0	0	0	0	0	0	0	0	0
								0x0000				0x0000				0x0000				0x0000						

`cmd x` represents pattern table entries. `x` here is the index number from 4 ~ 7.

Figure 38-4. APB_SARADC_SAR_PATT_TAB2_REG and Pattern Table Entry 4 - Entry 7

Each register consists of four 6-bit pattern table entries. Each entry is composed of three fields that contain the ADC channel and attenuation information, as shown in Table 38-5.

(reserved)		ch_sel		atten	
5	4	2	1	0	
0	xx		x	x	

Figure 38-5. Pattern Table Entry

atten Attenuation:

- 0: 0 dB
- 1: 2.5 dB
- 2: 6 dB
- 3: 12 dB

ch_sel ADC channel, see Table 38-1.

Configuration of multi-channel scanning

In this example, two channels are selected for multi-channel scanning:

- Channel 0 of SAR ADC, with the attenuation of 2.5 dB
- Channel 2 of SAR ADC, with the attenuation of 12 dB

The detailed configuration is as follows:

- Configure the first pattern table entry (cmd0):

(reserved)		ch_sel		atten	
5	4	2	1	0	
0	0		1		

Figure 38-6. cmd1 configuration

atten write the value of 1 to this field, to set the attenuation to 2.5 dB.

ch_sel write the value of 0 to this field, to select channel 0 (see Table 38-1).

- Configure the second pattern table entry (cmd1):

(reserved)		ch_sel		atten	
5	4	2	1	0	
0	2		3		

Figure 38-7. cmd0 Configuration

atten write the value of 3 to this field, to set the attenuation to 12 dB.

ch_sel write the value of 2 to this field, to select channel 2 (see Table 38-1).

- Configure `APB_SARADC_SAR_PATT_LEN` to 1, i.e., set pattern table length to (this value + 1 = 2). Then pattern table entries cmd0 and cmd1 will be used.

- Enable the timer, then DIG ADC controller starts scanning the two channels in cycles, as configured in the pattern table entries.

DMA Data Format

The ADC eventually passes 32-bit data to the DMA. See the figure below.

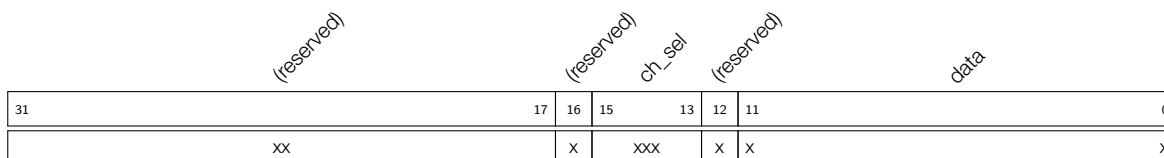

Figure 38-8. DMA Data Format

data SAR ADC read value; 12-bit

ch_sel Channel; 3-bit

38.2.3.6 ADC Filters

The DIG ADC controller provides two filters for automatic filtering of sampled ADC data. Both filters can be configured to any channel of the SAR ADC and then filter the sampled data for the target channel. The filter's formula is shown below:

$$data_{cur} = \frac{(k-1)data_{prev}}{k} + \frac{data_{in}}{k} - 0.5$$

- $data_{cur}$: the filtered data value.
- $data_{in}$: the sampled data value from the ADC.
- $data_{prev}$: the last filtered data value.
- k : the filter coefficient.

The filters are configured as follows:

- Configure `APB_SARADC_FILTER_CHANNEL x` to select the ADC channel for filter x .
- Configure `APB_SARADC_FILTER_FACTOR x` to set the coefficient for filter x .

Note that x is used here as the placeholder of filter index. 0: filter 0; 1: filter 1.

38.2.3.7 Threshold Monitoring

DIG ADC controller contains two threshold monitors that can be configured to monitor on any channel of the SAR ADC. A high threshold interrupt is triggered when the ADC sample value is larger than the pre-configured high threshold, and a low threshold interrupt is triggered if the sample value is lower than the pre-configured low threshold.

The configuration of threshold monitoring is as follows:

- Set `APB_SARADC_THRES x _EN` to enable threshold monitor x ;
- Configure `APB_SARADC_THRES x _LOW` to set a low threshold;
- Configure `APB_SARADC_THRES x _HIGH` to set a high threshold;

- Configure `APB_SARADC_THRESx_CHANNEL` to select the channel to monitor.

Note that `x` is used here as the placeholder of monitor index. 0 stands for monitor 0 and 1 for monitor 1.

38.3 Temperature Sensor

38.3.1 Overview

ESP32-C6 provides a temperature sensor to monitor temperature changes inside the chip in real time. Figure 38-9 shows the internal structure of the temperature sensor.

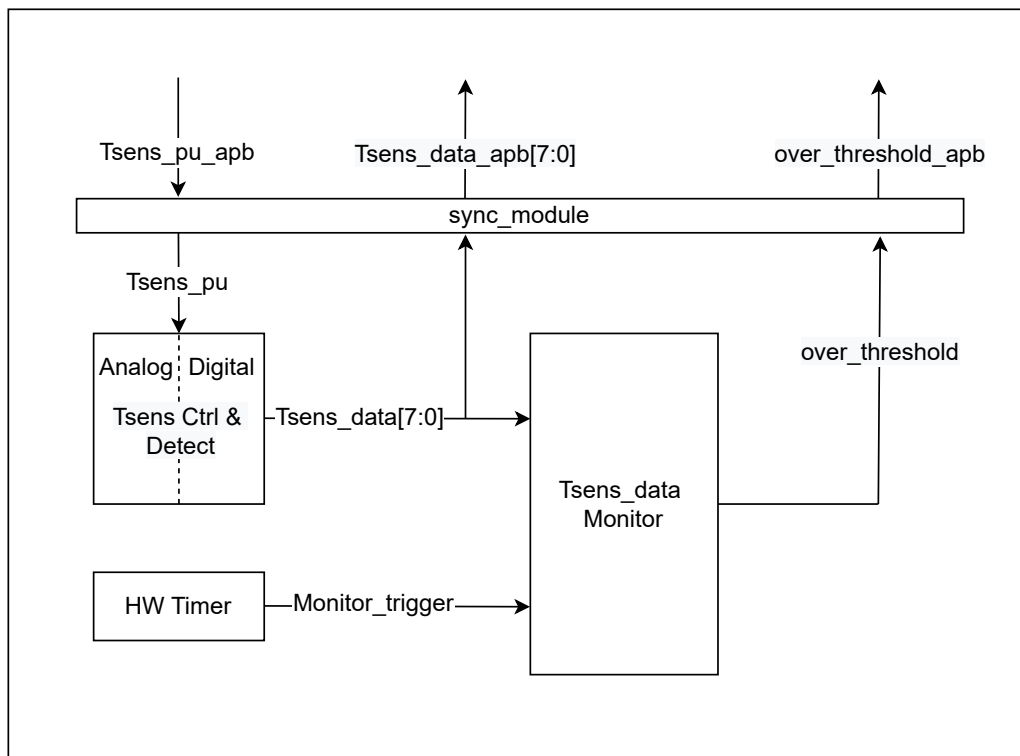

Figure 38-9. Temperature Sensor Structure

38.3.2 Features

The temperature sensor has the following features:

- Software triggering, wherein the data can be read continuously once triggered
- Hardware automatic triggering and temperature monitoring
- Configurable temperature offset based on the environment to improve the accuracy
- Adjustable measurement range

38.3.3 Functional Description

The temperature sensor can be started by software as follows:

- Set `APB_SARADC_TSENS_PU` to start XPD_SAR and to enable the temperature sensor; Set `PCR_TSENS_CLK_EN` to enable the temperature sensor clock;

- Wait for `APB_SARADC_TSENS_XPD_WAIT` clock cycles till the reset of the temperature sensor is released, then the sensor starts measuring the temperature;
- Wait for a while and then read the data from `APB_SARADC_TSENS_OUT`. The output value gradually approaches the actual temperature linearly as the measurement time increases.

The temperature sensor can also be automatically triggered to continuously monitor the temperature as follows:

- Set `APB_SARADC_TSENS_PU` to start XPD_SAR and to enable the temperature sensor; Set `PCR_TSENS_CLK_EN` to enable the temperature sensor clock;
- Wait for `APB_SARADC_TSENS_XPD_WAIT` clock cycles till the reset of the temperature sensor is released, then the sensor starts measuring the temperature;
- Configure `APB_SARADC_TSENS_SAMPLE_RATE` to set sample rate;
- Set `APB_SARADC_WAKEUP_MODE` to enable temperature monitor mode;
- Set `APB_SARADC_WAKEUP_EN` to enable temperature monitoring;
- Set `APB_SARADC_TSENS_SAMPLE_EN` to automatically start continuous temperature monitoring.

There are two wake-up modes for the temperature sensor to start automatic monitor:

- Absolute value mode:
 - Monitors the absolute value of the current temperature. Configure `APB_SARADC_WAKEUP_TH_LOW` and `APB_SARADC_WAKEUP_TH_HIGH` to set the temperature thresholds. Wake-up will be triggered if the sampled value exceeds the high threshold or is less than the low threshold.
- Incremental value mode:
 - Monitors the incremental value of the current temperature. If the temperature increment of two consecutive samplings exceeds the high threshold configured in `APB_SARADC_WAKEUP_TH_HIGH` or the temperature decrement of two consecutive samplings exceeds the low threshold configured in `APB_SARADC_WAKEUP_TH_LOW`, a wake-up will be triggered. For example, when `APB_SARADC_WAKEUP_TH_LOW` is configured as 8, if two consecutive sampling values are 28 and 19 respectively, i.e., the temperature decrement is 9, then a wake-up will be triggered.

The actual temperature (°C) can be obtained by converting the output of temperature sensor via the following formula:

$$T(^{\circ}C) = 0.4386 * VALUE - 27.88 * offset - 20.52$$

VALUE in the formula is the output of the temperature sensor, and the offset is determined by the temperature offset. The temperature offset varies in different actual environment (the temperature range). For details, refer to Table 38-2.

Table 38-2. Temperature Offset

Measurement Range (°C)	Temperature Offset (°C)
50 ~ 125	-2
20 ~ 100	-1
-10 ~ 80	0
-30 ~ 50	1
-40 ~ 20	2

38.4 Event Task Matrix Feature

The SAR ADC and temperature sensor on ESP32-C6 support the Event Task Matrix (ETM) function, which allows SAR ADC's/temperature sensor's ETM tasks to be triggered by any peripherals' ETM events, or SAR ADC's/temperature sensor's ETM events to trigger any peripherals' ETM tasks. This section introduces the ETM tasks and events related to SAR ADC and temperature sensor. For more information, please refer to Chapter 11 [Event Task Matrix \(SOC_ETM\)](#).

38.4.1 SAR ADC's ETM Feature

The SAR ADC can receive the following ETM tasks:

- `ADC_TASK_SAMPLE n` : ADC starts one-time sampling when this task is triggered.
- `ADC_TASK_START n` : ADC starts continuous sampling when this task is triggered.
- `ADC_TASK_STOP n` : ADC stops sampling when this task is triggered.

The SAR ADC can generate the following ETM events:

- `ADC_EVT_CONV_CMPLT n` : Generated when ADC completes a sampling.
- `ADC_EVT_EQ_ABOVE_THRESH n` : Generated when the ADC data is above the threshold.
- `ADC_EVT_EQ_BELOW_THRESH n` : Generated when the ADC data is below the threshold.
- `ADC_EVT_STARTED n` : Generated when ADC begins sampling; one-time sampling will not trigger this event.
- `ADC_EVT_STOPPED n` : Generated when ADC stops sampling, one-time sampling will not trigger this event.

In practical applications, SAR ADC's ETM events can trigger its own ETM tasks. For example, the `ADC_EVT_EQ_ABOVE_THRESH n` event can trigger the `ADC_TASK_STOP n` task.

38.4.2 Temperature Sensor's ETM Feature

The temperature sensor can generate the following ETM events:

- `TMPSNSR_EVT_OVER_LIMIT`: Generated when the temperature is beyond the threshold.

38.5 Interrupts

- `APB_SARADC_ADC_DONE_INT`: Triggered when SAR ADC completes one data conversion.
- `APB_SARADC_THRES x _HIGH_INT`: Triggered when the sampling value is higher than the high threshold of monitor x .
- `APB_SARADC_THRES x _LOW_INT`: Triggered when the sampling value is lower than the low threshold of monitor x .
- `APB_SARADC_TSENS_INT`: Triggered when the temperature sample value exceeds the threshold.

38.6 Register Summary

The addresses in this section are relative to On-Chip Sensors and Analog Signal Processing base address provided in Table 5-2 in Chapter 5 *System and Memory*.

The abbreviations given in Column **Access** are explained in Section *Access Types for Registers*.

Name	Description	Address	Access
Configure Register			
APB_SARADC_CTRL_REG	SAR ADC control register 1	0x0000	R/W
APB_SARADC_CTRL2_REG	SAR ADC control register 2	0x0004	R/W
APB_SARADC_FILTER_CTRL1_REG	Filtering control register 1	0x0008	R/W
APB_SARADC_SAR_PATT_TAB1_REG	Pattern table register 1	0x0018	R/W
APB_SARADC_SAR_PATT_TAB2_REG	Pattern table register 2	0x001C	R/W
APB_SARADC_ONETIME_SAMPLE_REG	Configuration register for one-time sampling	0x0020	R/W
APB_SARADC_FILTER_CTRL0_REG	Filtering control register 0	0x0028	R/W
APB_SARADC_SAR1DATA_STATUS_REG	SAR ADC sampling data register	0x002C	RO
APB_SARADC_THRES0_CTRL_REG	Sampling threshold control register 0	0x0034	R/W
APB_SARADC_THRES1_CTRL_REG	Sampling threshold control register 1	0x0038	R/W
APB_SARADC_THRES_CTRL_REG	Sampling threshold control register	0x003C	R/W
APB_SARADC_INT_ENA_REG	Enable register of SAR ADC interrupts	0x0040	R/W
APB_SARADC_INT_RAW_REG	Raw register of SAR ADC interrupts	0x0044	R/WTC/SS
APB_SARADC_INT_ST_REG	State register of SAR ADC interrupts	0x0048	RO
APB_SARADC_INT_CLR_REG	Clear register of SAR ADC interrupts	0x004C	WT
APB_SARADC_DMA_CONF_REG	DMA configuration register for SAR ADC	0x0050	R/W
APB_SARADC_APB_TSENS_CTRL_REG	Temperature sensor control register 1	0x0058	varies
APB_SARADC_TSENS_CTRL2_REG	Temperature sensor control register 2	0x005C	R/W
APB_SARADC_CALI_REG	SAR ADC calibration register	0x0060	R/W
APB_TSENS_WAKE_REG	Temperature sensor configuration register	0x0064	varies
APB_TSENS_SAMPLE_REG	Temperature sensor configuration register	0x0068	R/W
APB_SARADC_CTRL_DATE_REG	Version control register	0x03FC	R/W

38.7 Registers

The addresses in this section are relative to On-Chip Sensors and Analog Signal Processing base address provided in Table 5-2 in Chapter 5 *System and Memory*.

Register 38.1. APB_SARADC_CTRL_REG (0x0000)

APB_SARADC_WAIT_ARB_CYCLE (reserved)		APB_SARADC_XPD_SAR_FORCE (reserved)		APB_SARADC_SAR_PATT_P_CLEAR (reserved)		APB_SARADC_SAR_PATT_LEN		APB_SARADC_SAR_CLK_DIV		APB_SARADC_SAR_CLK_GATED (reserved)		APB_SARADC_START APB_SARADC_START_FORCE									
31	30	29	28	27	26	24	23	22	18	17	15	14	7	6	5	2	1	0			
1	0	0	0	0	0	0	0	0	0	0	0	7	4	1	0	0	0	0	0	0	0

Reset

APB_SARADC_START_FORCE Configures whether to use software to enable SAR ADC.

0: Select FSM to start SAR ADC

1: Select software to start SAR ADC

(R/W)

APB_SARADC_START Configures whether to start SAR ADC by software.

0: No effect

1: Start SAR ADC by software

Valid only when [APB_SARADC_START_FORCE](#) = 1.

(R/W)

APB_SARADC_SAR_CLK_GATED Configures whether to enable SAR ADC clock gate.

0: Disable

1: Enable

(R/W)

APB_SARADC_SAR_CLK_DIV Configures SAR ADC clock divider. This value should be no less than

2. (R/W)

APB_SARADC_SAR_PATT_LEN Configures how many pattern table entries will be used.

0: Only cmd3 will be used

1: Pattern table entries cmd0 and cmd1 will be used

(R/W)

APB_SARADC_SAR_PATT_P_CLEAR Configures whether to clear the pointer of pattern table for DIG ADC controller.

0: No effect

1: Clear

(R/W)

APB_SARADC_XPD_SAR_FORCE Configures whether to force select XPD SAR.

0: No effect

1: Force select XPD SAR

(R/W)

APB_SARADC_WAIT_ARB_CYCLE Configures the clock cycle of waiting arbitration signal stable after SAR_DONE. (R/W)

Register 38.2. APB_SARADC_CTRL2_REG (0x0004)

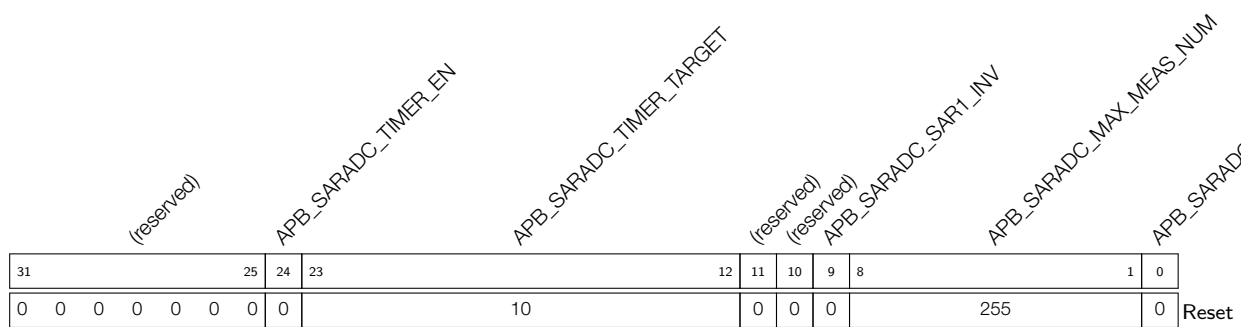

APB_SARADC_MEAS_NUM_LIMIT Configures whether to enable the limitation of SAR ADC's maximum conversion times.

- 0: Disable
 - 1: Enable
- (R/W)

APB_SARADC_MAX_MEAS_NUM Configures the SAR ADC's maximum conversion times. (R/W)

APB_SARADC_SAR1_INV Configures whether to invert the data of SAR ADC.

- 0: No effect
 - 1: Invert the data of SAR ADC
- (R/W)

APB_SARADC_TIMER_TARGET Configures SAR ADC timer target. (R/W)

APB_SARADC_TIMER_EN Configures whether to enable SAR ADC timer trigger.

- 0: Disable
 - 1: Enable
- (R/W)

Register 38.3. APB_SARADC_FILTER_CTRL1_REG (0x0008)

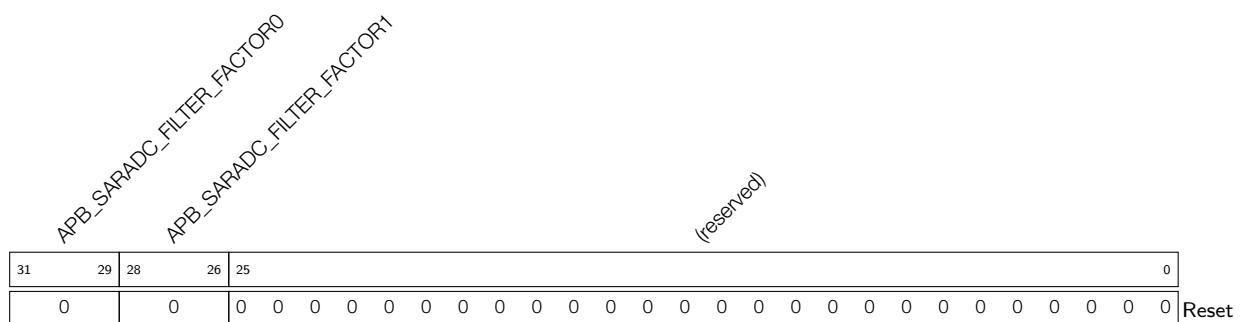

APB_SARADC_FILTER_FACTOR1 Configures the filter coefficient for SAR ADC filter 1. (R/W)

APB_SARADC_FILTER_FACTOR0 Configures the filter coefficient for SAR ADC filter 0. (R/W)

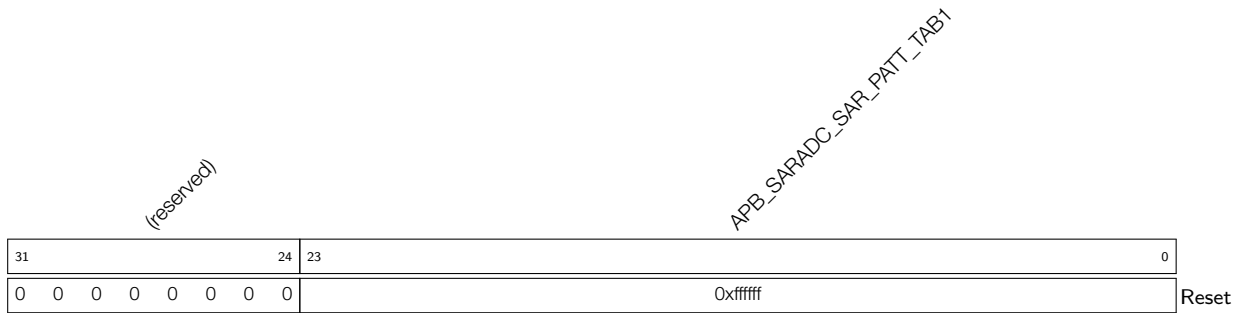
Register 38.4. APB_SARADC_SAR_PATT_TAB1_REG (0x0018)

APB_SARADC_SAR_PATT_TAB1 Configures pattern table entries 0 ~ 3 (each entry takes six bits).
(R/W)

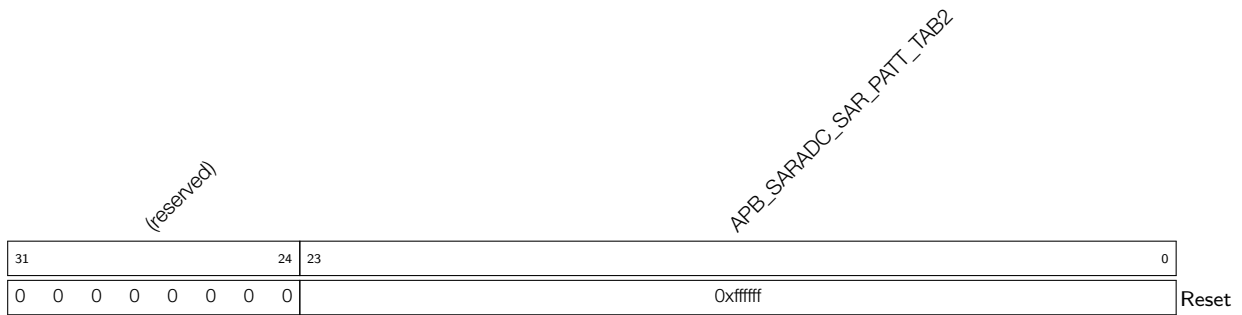
Register 38.5. APB_SARADC_SAR_PATT_TAB2_REG (0x001C)

APB_SARADC_SAR_PATT_TAB2 Configures pattern table entries 4 ~ 7 (each entry takes six bits).
(R/W)

Register 38.6. APB_SARADC_ONETIME_SAMPLE_REG (0x0020)

<i>APB_SARADC_ONETIME_SAMPLE</i> (reserved)			<i>APB_SARADC_ONETIME_START</i>			<i>APB_SARADC_ONETIME_CHANNEL</i>			<i>(reserved)</i>																						
31	30	29	28	25	24	23	22																					0			
0	0	0	13			0	0 0																				0	Reset			

APB_SARADC_ONETIME_ATTEN Configures the attenuation for a one-time sampling. (R/W)

APB_SARADC_ONETIME_CHANNEL Configures the channel for a one-time sampling. (R/W)

APB_SARADC_ONETIME_START Configures whether to start SAR ADC one-time sampling.

0: No effect

1: Start

(R/W)

APB_SARADC_ONETIME_SAMPLE Configures whether to enable SAR ADC one-time sampling.

0: Disable

1: Enable

(R/W)

Register 38.7. APB_SARADC_FILTER_CTRL0_REG (0x0028)

<i>APB_SARADC_FILTER_RESET</i> (reserved)			<i>APB_SARADC_FILTER_CHANNEL0</i>			<i>APB_SARADC_FILTER_CHANNEL1</i>			<i>(reserved)</i>																	
31	30	26	25	22	21	18	17														0					
0	0	0	0	0	0	13			13			0 0													0	Reset

APB_SARADC_FILTER_CHANNEL1 Configures the filter channel for SAR ADC filter 1. (R/W)

APB_SARADC_FILTER_CHANNEL0 Configures the filter channel for SAR ADC filter 0. (R/W)

APB_SARADC_FILTER_RESET Configures whether to reset SAR ADC filter.

0: No effect

1: Reset

(R/W)

Register 38.8. APB_SARADC_SAR1DATA_STATUS_REG (0x002C)

31	(reserved)	17	APB_SARADC_DATA	0
0 0 0 0 0 0 0 0 0 0 0 0 0 0 0 0		0		
Reset				

APB_SARADC_DATA Represents SAR ADC conversion data. (RO)

Register 38.9. APB_SARADC_THRES0_CTRL_REG (0x0034)

31	(reserved)	18	APB_SARADC_THRES0_LOW	17	APB_SARADC_THRES0_HIGH	5	(reserved)	4	APB_SARADC_THRES0_CHANNEL	3	0
0		0		0x1fff			0		13		
Reset											

APB_SARADC_THRES0_CHANNEL Configures the channel for SAR ADC monitor 0. (R/W)

APB_SARADC_THRES0_HIGH Configures the high threshold for SAR ADC monitor 0. (R/W)

APB_SARADC_THRES0_LOW Configures the low threshold for SAR ADC monitor 0. (R/W)

Register 38.10. APB_SARADC_THRES1_CTRL_REG (0x0038)

31	(reserved)	18	APB_SARADC_THRES1_LOW	17	APB_SARADC_THRES1_HIGH	5	(reserved)	4	APB_SARADC_THRES1_CHANNEL	3	0
0		0		0x1fff			0		13		
Reset											

APB_SARADC_THRES1_CHANNEL Configures the channel for SAR ADC monitor 1. (R/W)

APB_SARADC_THRES1_HIGH Configures the high threshold for SAR ADC monitor 1. (R/W)

APB_SARADC_THRES1_LOW Configures the low threshold for SAR ADC monitor 1. (R/W)

Register 38.11. APB_SARADC_THRES_CTRL_REG (0x003C)

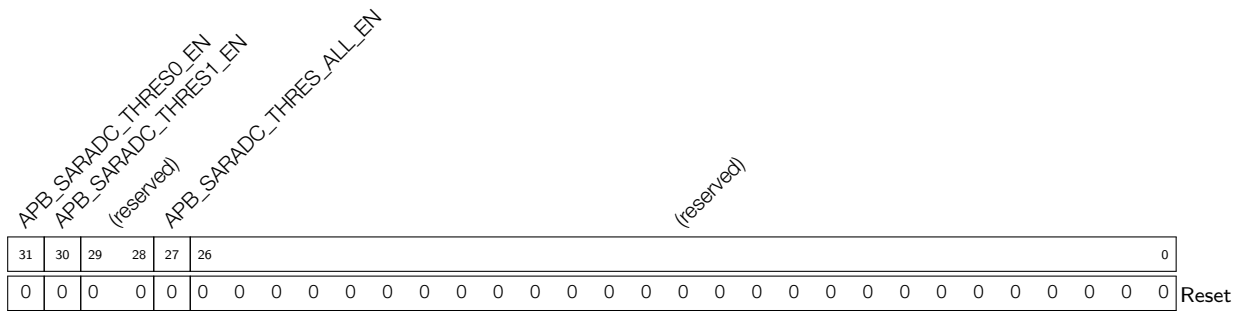

APB_SARADC_THRES_ALL_EN Configures whether to enable the threshold monitoring for all configured channels.

0: Disable

1: Enable

(R/W)

APB_SARADC_THRES1_EN Configures whether to enable threshold monitor 1.

0: Disable

1: Enable

(R/W)

APB_SARADC_THRES0_EN Configures whether to enable threshold monitor 0.

0: Disable

1: Enable

(R/W)

Register 38.14. APB_SARADC_INT_ST_REG (0x0048)

APB_SARADC_ADC_DONE_INT_ST		(reserved)		APB_SARADC_THRES0_HIGH_INT_ST		APB_SARADC_THRES1_HIGH_INT_ST		APB_SARADC_THRES0_LOW_INT_ST		APB_SARADC_THRES1_LOW_INT_ST		APB_SARADC_TSENS_INT_ST		(reserved)		0		
31	30	29	28	27	26	25	24											0
0	0	0	0	0	0	0	0	0	0	0	0	0	0	0	0	0	0	

Reset

APB_SARADC_TSENS_INT_ST The masked interrupt status of the [APB_SARADC_TSENS_INT](#) interrupt. (RO)

APB_SARADC_THRES1_LOW_INT_ST The masked interrupt status of the [APB_SARADC_THRES1_LOW_INT](#) interrupt. (RO)

APB_SARADC_THRES0_LOW_INT_ST The masked interrupt status of the [APB_SARADC_THRES0_LOW_INT](#) interrupt. (RO)

APB_SARADC_THRES1_HIGH_INT_ST The masked interrupt status of the [APB_SARADC_THRES1_HIGH_INT](#) interrupt. (RO)

APB_SARADC_THRES0_HIGH_INT_ST The masked interrupt status of the [APB_SARADC_THRES0_HIGH_INT](#) interrupt. (RO)

APB_SARADC_ADC_DONE_INT_ST The masked interrupt status of the [APB_SARADC_ADC_DONE_INT](#) interrupt. (RO)

Register 38.16. APB_SARADC_DMA_CONF_REG (0x0050)

APB_SARADC_APB_ADC_TRANS		(reserved)																APB_SARADC_APB_ADC_EOF_NUM	
31	30	29														16	15	0	
0	0	0	0	0	0	0	0	0	0	0	0	0	0	0	0	0	0	255	Reset

APB_SARADC_APB_ADC_EOF_NUM Configures whether to enable generating dma_in_suc_eof when sample cnt = eof_num.

0: No effect

1: Generate

(R/W)

APB_SARADC_APB_ADC_RESET_FSM Configures whether to reset DIG ADC controller status.

0: No effect

1: Reset

(R/W)

APB_SARADC_APB_ADC_TRANS Configures whether to let DIG ADC controller use DMA.

0: No effect

1: DIG ADC controller uses DMA

(R/W)

Register 38.17. APB_SARADC_APB_TSENS_CTRL_REG (0x0058)

(reserved)								APB_SARADC_TSENS_PU				APB_SARADC_TSENS_CLK_DIV				APB_SARADC_TSENS_IN_INV				(reserved)								APB_SARADC_TSENS_OUT								
31									23	22	21				14	13	12					8	7									0				
0 0 0 0 0 0 0 0								0								6				0				0 0 0 0 0 0				0x80								Reset

APB_SARADC_TSENS_OUT Represents temperature sensor data out. (RO)

APB_SARADC_TSENS_IN_INV Configures whether to invert temperature sensor data.

0: No effect

1: Invert

(R/W)

APB_SARADC_TSENS_CLK_DIV Configures temperature sensor clock divider. (R/W)

APB_SARADC_TSENS_PU Configures whether to power up temperature sensor.

0: No effect

1: Power up

(R/W)

Register 38.18. APB_SARADC_TSENS_CTRL2_REG (0x005C)

(reserved)																APB_SARADC_TSENS_CLK_SEL		APB_SARADC_TSENS_CLK_INV		APB_SARADC_TSENS_XPD_FORCE				APB_SARADC_TSENS_XPD_WAIT					
31															16	15	14	13	12	11									0
0																0		0x0		0x0				0x2				Reset	

APB_SARADC_TSENS_CLK_SEL Configures the working clock for temperature sensor.

0: RC_FAST_CLK

1: XTAL_CLK

(R/W)

APB_SARADC_TSENS_CLK_INV Configures the phase of sensor sample clock. (R/W)

APB_SARADC_TSENS_XPD_FORCE Configures whether to enable force power up/down the temperature sensor.

0/1: Disable force power up/down function

2: Enable force power up temperature sensor

3: Enable force power down temperature sensor

(R/W)

APB_SARADC_TSENS_XPD_WAIT Configure the wait time for analog circuit build up. (R/W)

Register 38.19. APB_SARADC_CALI_REG (0x0060)

(reserved)																APB_SARADC_CALI_CFG									
31															17	16									0
0																0x8000				Reset					

APB_SARADC_CALI_CFG Configures the SAR ADC calibration factor. (R/W)

Register 38.20. APB_TSENS_WAKE_REG (0x0064)

(reserved)										APB_SARADC_WAKEUP_EN			APB_SARADC_WAKEUP_MODE			APB_SARADC_WAKEUP_OVER_UPPER_TH			APB_SARADC_WAKEUP_TH_HIGH			APB_SARADC_WAKEUP_TH_LOW										
31																			19	18	17	16	15				8	7				0
0 0 0 0 0 0 0 0 0 0										0 0 0			0xf			0x0			Reset													

APB_SARADC_WAKEUP_TH_LOW Configures the low threshold for temperature sensor wake-up function. (R/W)

APB_SARADC_WAKEUP_TH_HIGH Configures the high threshold for temperature sensor wake-up function. (R/W)

APB_SARADC_WAKEUP_OVER_UPPER_TH Represents whether the temperature value exceeds the threshold.

- 0: The temperature value is below the low threshold
 - 1: The temperature value is above the high threshold
- (RO)

APB_SARADC_WAKEUP_MODE Configures the wake-up mode for temperature sensor.

- 0: Absolute value mode
- 1: Incremental value mode

(R/W)

APB_SARADC_WAKEUP_EN Configures whether to enable wake-up.

- 0: Disable
- 1: Enable

(R/W)

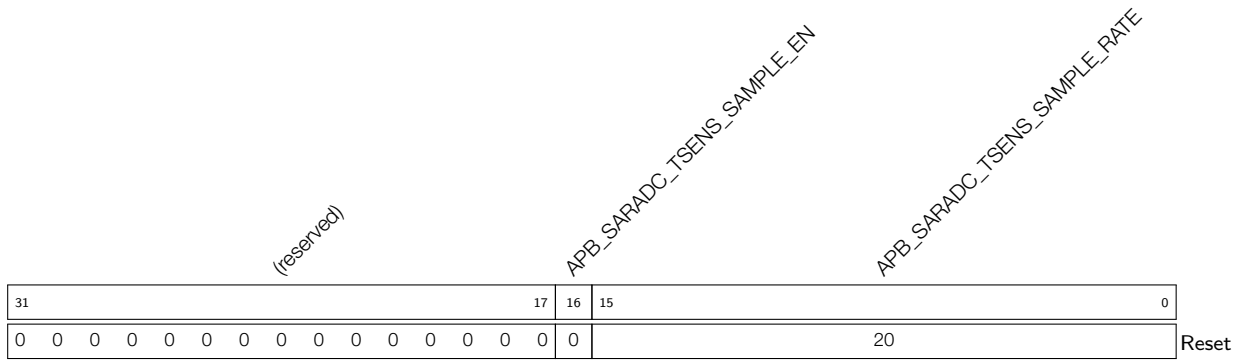
Register 38.21. APB_TSENS_SAMPLE_REG (0x0068)

APB_SARADC_TSENS_SAMPLE_RATE Configures the hardware sampling rate. (R/W)

APB_SARADC_TSENS_SAMPLE_EN Configures whether to enable hardware sampling.

0: Disable

1: Enable

(R/W)

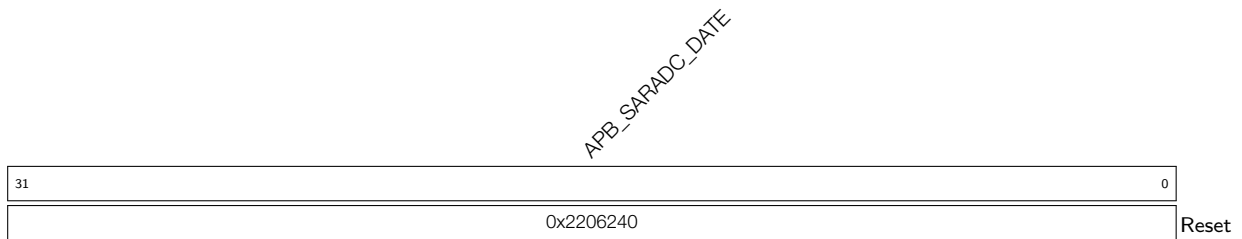
Register 38.22. APB_SARADC_CTRL_DATE_REG (0x03FC)

APB_SARADC_DATE Version control register. (R/W)

39 Related Documentation and Resources

Related Documentation

- [ESP32-C6 Series Datasheet](#) – Specifications of the ESP32-C6 hardware.
- [ESP32-C6 Hardware Design Guidelines](#) – Guidelines on how to integrate the ESP32-C6 into your hardware product.
- *Certificates*
<https://espressif.com/en/support/documents/certificates>
- *ESP32-C6 Product/Process Change Notifications (PCN)*
<https://espressif.com/en/support/documents/pcns?keys=ESP32-C6>
- *Documentation Updates and Update Notification Subscription*
<https://espressif.com/en/support/download/documents>

Developer Zone

- [ESP-IDF Programming Guide for ESP32-C6](#) – Extensive documentation for the ESP-IDF development framework.
- *ESP-IDF* and other development frameworks on GitHub.
<https://github.com/espressif>
- *ESP32 BBS Forum* – Engineer-to-Engineer (E2E) Community for Espressif products where you can post questions, share knowledge, explore ideas, and help solve problems with fellow engineers.
<https://esp32.com/>
- *The ESP Journal* – Best Practices, Articles, and Notes from Espressif folks.
<https://blog.espressif.com/>
- See the tabs *SDKs and Demos, Apps, Tools, AT Firmware*.
<https://espressif.com/en/support/download/sdk-demos>

Products

- *ESP32-C6 Series SoCs* – Browse through all ESP32-C6 SoCs.
<https://espressif.com/en/products/socs?id=ESP32-C6>
- *ESP32-C6 Series Modules* – Browse through all ESP32-C6-based modules.
<https://espressif.com/en/products/modules?id=ESP32-C6>
- *ESP32-C6 Series DevKits* – Browse through all ESP32-C6-based devkits.
<https://espressif.com/en/products/devkits?id=ESP32-C6>
- *ESP Product Selector* – Find an Espressif hardware product suitable for your needs by comparing or applying filters.
<https://products.espressif.com/#/product-selector?language=en>

Contact Us

- See the tabs *Sales Questions, Technical Enquiries, Circuit Schematic & PCB Design Review, Get Samples* (Online stores), *Become Our Supplier, Comments & Suggestions*.
<https://espressif.com/en/contact-us/sales-questions>

Glossary

Abbreviations for Peripherals

AES	AES (Advanced Encryption Standard) Accelerator
DS	Digital Signature
DMA	DMA (Direct Memory Access) Controller
ECC	ECC (Elliptic Curve Cryptography) Accelerator
eFuse	eFuse Controller
ETM	Event Task Matrix
HMAC	HMAC (Hash-based Message Authentication Code) Accelerator
HP CPU	High-Performance CPU
I2C	I2C (Inter-Integrated Circuit) Controller
I2S	I2S (Inter-IC Sound) Controller
LEDC	LED PWM (Pulse Width Modulation) Controller
LP CPU	Low-Power CPU
MCPWM	Motor Control PWM (Pulse Width Modulation)
PARLIO	Parallel IO Controller
PCNT	Pulse Count Controller
RMT	Remote Control Peripheral
RNG	Random Number Generator
RSA	RSA (Rivest Shamir Adleman) Accelerator
SDIO	SDIO 2.0 Slave Controller
SHA	SHA (Secure Hash Algorithm) Accelerator
SPI	SPI (Serial Peripheral Interface) Controller
SYSTIMER	System Timer
TIMG	Timer Group
TWAI	Two-wire Automotive Interface
UART	UART (Universal Asynchronous Receiver-Transmitter) Controller
WDT	Watchdog Timers

Abbreviations Related to Registers

REG	Register.
SYSREG	System registers are a group of registers that control system reset, memory, clocks, software interrupts, power management, clock gating, etc.
ISO	Isolation. If a peripheral or other chip component is powered down, the pins, if any, to which its output signals are routed will go into a floating state. ISO registers isolate such pins and keep them at a certain determined value, so that the other non-powered-down peripherals/devices attached to these pins are not affected.
NMI	Non-maskable interrupt is a hardware interrupt that cannot be disabled or ignored by the CPU instructions. Such interrupts exist to signal the occurrence of a critical error.

- W1TS Abbreviation added to names of registers/fields to indicate that such register/field should be used to set a field in a corresponding register with a similar name. For example, the register `GPIO_ENABLE_W1TS_REG` should be used to set the corresponding fields in the register `GPIO_ENABLE_REG`.
- W1TC Same as *W1TS*, but used to clear a field in a corresponding register.

Access Types for Registers

Sections *Register Summary* and *Register Description* in TRM chapters specify access types for registers and their fields.

Most frequently used access types and their combinations are as follows:

- | | | | |
|-------|-------------|--------------|---------------|
| • RO | • R/W/SC | • R/WC/SS/SC | • R/SC/WTC |
| • WO | • R/W/SS | • R/WS/SC | • R/SS/SC/WTC |
| • WT | • R/W/SS/SC | • R/WS/SS | • RF/WF |
| • R/W | • R/WC/SS | • R/WS/SS/SC | • R/SS/RC |
| • WL | • R/WC/SC | • R/SS/WTC | • varies |

Descriptions of all access types are provided below.

- R **Read.** User application can read from this register/field; usually combined with other access types.
- RO **Read only.** User application can only read from this register/field.
- HRO **Hardware Read Only.** Only hardware can read from this register/field; used for storing default settings for variable parameters.
- W **Write.** User application can write to this register/field; usually combined with other access types.
- WO **Write only.** User application can only write to this register/field.
- SS **Self set.** On a specified event, hardware automatically writes 1 to this register/field; used with 1-bit fields.
- SC **Self clear.** On a specified event, hardware automatically writes 0 to this register/field; used with 1-bit and multi-bit fields.
- SM **Self modify.** On a specified event, hardware automatically writes a specified value to this register/field; used with multi-bit fields.
- RS **Read to set.** If user application reads from this register/field, hardware automatically writes 1 to it.
- RC **Read to clear.** If user application reads from this register/field, hardware automatically writes 0 to it.
- RF **Read from FIFO.** If user application writes new data to FIFO, the register/field automatically reads it.
- WF **Write to FIFO.** If user application writes new data to this register/field, it automatically passes the data to FIFO via APB bus.
- WS **Write any value to set.** If user application writes to this register/field, hardware automatically sets this register/field.
- W1S **Write 1 to set.** If user application writes 1 to this register/field, hardware automatically sets this register/field.
- W0S **Write 0 to set.** If user application writes 0 to this register/field, hardware automatically sets this register/field.
- WC **Write any value to clear.** If user application writes to this register/field, hardware automatically clears this register/field.

- W1C **Write 1 to clear.** If user application writes 1 to this register/field, hardware automatically clears this register/field.
- W0C **Write 0 to clear.** If user application writes 0 to this register/field, hardware automatically clears this register/field.
- WT **Write 1 to trigger an event.** If user application writes 1 to this field, this action triggers an event (pulse in the APB bus) or clears a corresponding WTC field (see WTC).
- WTC **Write to clear.** Hardware automatically clears this field if user application writes 1 to the corresponding WT field (see WT).
- W1T **Write 1 to toggle.** If user application writes 1 to this field, hardware automatically inverts the corresponding field; otherwise - no effect.
- W0T **Write 0 to toggle.** If user application writes 0 to this field, hardware automatically inverts the corresponding field; otherwise - no effect.
- WL **Write if a lock is deactivated.** If the lock is deactivated, user application can write to this register/field.
- varies **The access type varies.** Different fields of this register might have different access types.

Revision History

Date	Version	Release notes
2023-06-07	v0.3	<p>Added the following chapter:</p> <ul style="list-style-type: none"> Chapter 3 <i>Low-Power CPU</i> <p>Updated the following chapters:</p> <ul style="list-style-type: none"> Chapter 1 <i>High-Performance CPU</i>: Fixed interrupt IDs Chapter 6 <i>eFuse Controller</i>: Updated the description of register EFUSE_SEC_DPA_LEVEL Chapter 8 <i>Reset and Clock</i>: Updated the description to Reset fields in Section 8.4.1 <i>PCR Registers</i> Chapter 10 <i>Interrupt Matrix (INTMTX)</i>: Added the LP_PERI_TIMEOUT_INTR interrupt source Chapter 15 <i>Permission Control (PMS)</i> added 15-1, and updated relevant descriptions Chapter 27 <i>SPI Controller (SPI)</i> Updated clock information Chapter 38 <i>On-Chip Sensor and Analog Signal Processing</i>: Updated Section 38.4 <i>Event Task Matrix Feature</i> <p>Added Section <i>Programming Reserved Register Field</i></p>

Cont'd on next page

Cont'd from previous page

Date	Version	Release notes
2023-04-20	v0.2	<p>Added the following chapters:</p> <ul style="list-style-type: none"> • Chapter 1 High-Performance CPU • Chapter 2 RISC-V Trace Encoder (TRACE) • Chapter 33 SDIO 2.0 Slave Controller (SDIO) • Chapter 37 Parallel IO Controller (PARL_IO) <p>Updated the following chapters:</p> <ul style="list-style-type: none"> • Chapter 4 GDMA Controller (GDMA): Updated the descriptions of the GDMA_IN_SUC_EOF_CHn_INT interrupt and the GDMA_INLINK_DSCR_ADDR_CHn field • Chapter 6 eFuse Controller: Added a note on programming the XTS-AES key • Chapter 8 Reset and Clock: Changed RC_FAST_CLK to 17.5 MHz, and changed RC_SLOW_CLK to 136 kHz • Chapter 10 Interrupt Matrix (INTMTX): Updated the names for several registers • Chapter 11 Event Task Matrix (SOC_ETM): Updated the complete procedure to configure ETM channels • Chapter 17 Debug Assistant (ASSIST_DEBUG): Added two registers, ASSIST_DEBUG_CLOCK_GATE_REG and MEM_MONITOR_CLOCK_GATE_REG; Updated Table 17-5 • Chapter 21 RSA Accelerator (RSA), 22 SHA Accelerator (SHA), and 18 AES Accelerator (AES): Updated the register to enable the accelerators • Chapter 26 UART Controller (UART, LP_UART, UHC): Updated the maximum length of stop bits and related descriptions • Chapter 38 On-Chip Sensor and Analog Signal Processing: Updated the pattern table indexes in Figure 38-3 and Figure 38-4 <p>Updated abbreviations for peripherals and added “varies” as an access type for registers in the Glossary section</p>
2023-01-13	v0.1	Preliminary release



www.espressif.com

Disclaimer and Copyright Notice

Information in this document, including URL references, is subject to change without notice.

ALL THIRD PARTY'S INFORMATION IN THIS DOCUMENT IS PROVIDED AS IS WITH NO WARRANTIES TO ITS AUTHENTICITY AND ACCURACY.

NO WARRANTY IS PROVIDED TO THIS DOCUMENT FOR ITS MERCHANTABILITY, NON-INFRINGEMENT, FITNESS FOR ANY PARTICULAR PURPOSE, NOR DOES ANY WARRANTY OTHERWISE ARISING OUT OF ANY PROPOSAL, SPECIFICATION OR SAMPLE.

All liability, including liability for infringement of any proprietary rights, relating to use of information in this document is disclaimed. No licenses express or implied, by estoppel or otherwise, to any intellectual property rights are granted herein.

The Wi-Fi Alliance Member logo is a trademark of the Wi-Fi Alliance. The Bluetooth logo is a registered trademark of Bluetooth SIG.

All trade names, trademarks and registered trademarks mentioned in this document are property of their respective owners, and are hereby acknowledged.

Copyright © 2023 Espressif Systems (Shanghai) Co., Ltd. All rights reserved.

PRELIMINARY